

Model Machine

MACSAE064

SAECO AROMA SE 200 SILVER

MACSAE064.T.0001

TAVOLA NR. 1 - ARTICOLO SAECO AROMA SE 200 SILVER



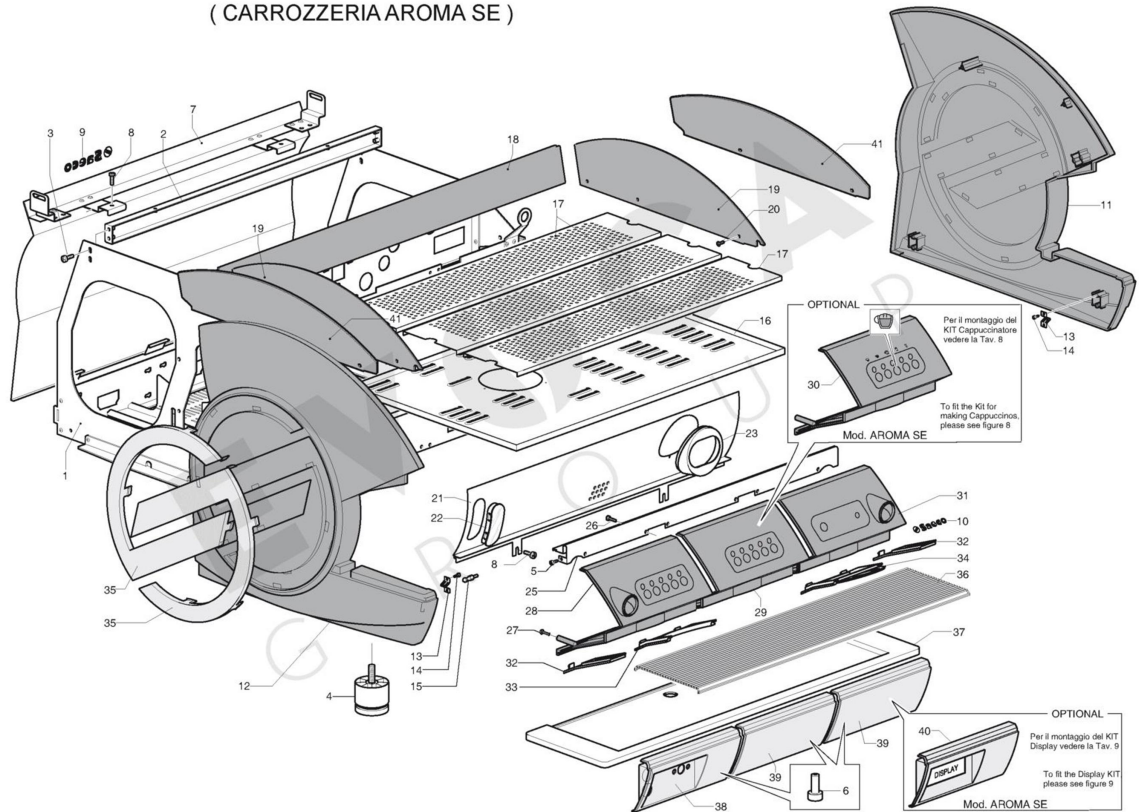









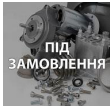

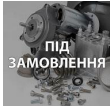

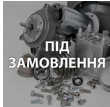

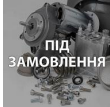

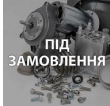

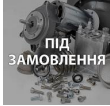

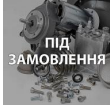
(CARROZZERIA AROMA SE)

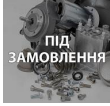

Model Machine

MACSAE064

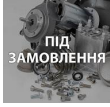

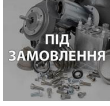







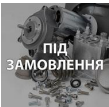

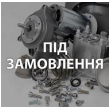

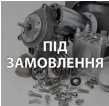











SAECO AROMA SE 200 SILVER

Web	Pos.	Foto	Item - Replace by	Description
				<i>Press - CTRL + CLICK go to item in a new window Натисніть - Ctrl + права кнопка миші щоб відкрити запчастину в новому вікні</i>
	1		11011944	FRAME ASS. 2 HEADS UL <i>FRAME ASS. 2 HEADS UL</i>
	1		8003011003	FRAME UNIT 3 HEADS <i>FRAME UNIT 3 HEADS</i>
	1		8003011004	FRAME UNIT 4 HEADS <i>FRAME UNIT 4 HEADS</i>
	2		WGA8001006002	TOP REAR CROSS-BRACE 2 HEAD <i>TOP REAR CROSS-BRACE 2 HEAD</i>
	2		WGA8001006003	TOP REAR CROSS-BRACE 3 HEAD <i>TOP REAR CROSS-BRACE 3 HEAD</i>
	2		WGA8001006004	TOP REAR CROSS-BRACE 4 HEAD <i>TOP REAR CROSS-BRACE 4 HEAD</i>
	3		WGADI7986-5X14Z	SCREWS M 5X14 GALVANISED (DIN7985/U) <i>SCREWS M 5X14 GALVANISED (DIN7985/U)</i>
	4		WGA5011001000	STAINLESS STEEL FOOT <i>PIEDINO ACCIAIO INOX</i>
	5		129573402	SCREW TAPT M4X10 DIN 7985 GALV <i>SCREW TAPT M4X10 DIN 7985 GALV</i>
	6		WGA4001157000	INSERT EXTRACTION TOOL <i>INSERT EXTRACTION TOOL</i>
	7		8003005014	SILVER 4 HEADS BACK <i>SILVER 4 HEADS BACK</i>
	7		WGA8003005002	COMPLETE REAR PANEL - BLUE 2 UNITS <i>COMPLETE REAR PANEL - BLUE 2 UNITS</i>

Model Machine

MACSAE064

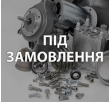









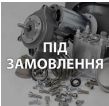

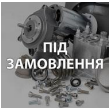













SAECO AROMA SE 200 SILVER

	7		WGA8003005003	COMPLETE REAR PANEL - BLUE 3 UNITS <i>COMPLETE REAR PANEL - BLUE 3 UNITS</i>
	7		WGA8003005004	BLUE 4 HEADS BACK <i>BLUE 4 HEADS BACK</i>
	7		WGA8003005012	COMPLETE REAR PANEL SILVER 2 UNITS <i>CHIUSURA POST COMPLETA SILVER 2GR</i>
	7		WGA8003005013	COMPLETE REAR PANEL SILVER 3 UNITS <i>COMPLETE REAR PANEL SILVER 3 UNITS</i>
	8		WGADI7986-5X10I	SCREWS M 5X10 ST.STEEL (DIN7985/UNI) <i>SCREWS M 5X10 ST.STEEL (DIN7985/UNI)</i>
	9		1037.012	SAECO TRADEMARK - LENGTH 150 <i>SAECO TRADEMARK - LENGTH 150</i>
	10		1037.014	SAECO L.54 LOGO <i>SAECO L.54 LOGO</i>
	11		11011881	RIGHT SIDE SILVER UL <i>RIGHT SIDE SILVER UL</i>
	11		11022358	RIGHT SIDE BLUE UL <i>RIGHT SIDE BLUE UL</i>
	12		11011883	LEFT SIDE SILVER UL <i>LEFT SIDE SILVER UL</i>
	12		11022355	LEFT SIDE BLUE UL <i>LEFT SIDE BLUE UL</i>
	13		WGA5001004000	SNAP FITTING SPRING <i>SNAP FITTING SPRING</i>
	14		DI7981P3.5X13Z	SELF TAPPING GALV. SCREWPLAST <i>SELF TAPPING GALV. SCREWPLAST</i>
	15		WGA5001003000	INSERT FOR SNAP FITTING SPRING <i>INSERT FOR SNAP FITTING SPRING</i>

Model Machine

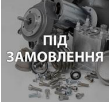
MACSAE064













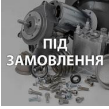

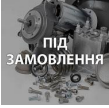

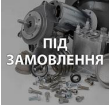

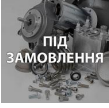

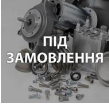

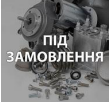

SAECO AROMA SE 200 SILVER

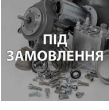
	16		WGA8001015002	CUP WARMER TRAY - 2 UNITS <i>CUP WARMER TRAY - 2 UNITS</i>
	16		WGA8001015003	COFFEE CONT. ASS.DA 10P BROWN <i>COFFEE CONT. ASS.DA 10P BROWN</i>
	16		WGA8001015004	COFFEE CONT. ASS.DA 10P BROWN <i>COFFEE CONT. ASS.DA 10P BROWN</i>
	17		WGA4001034002	RING NUT <i>RING NUT</i>
	17		WGA4001034003	RING NUT <i>RING NUT</i>
	17		WGA4001034004	RING NUT <i>RING NUT</i>
	18		WGA4003026002	CUP WARMER BACK SIDE - 2 UNITS <i>CUP WARMER BACK SIDE - 2 UNITS</i>
	18		WGA4003026003	CUP WARMER BACK SIDE - 3 UNITS <i>CUP WARMER BACK SIDE - 3 UNITS</i>
	18		WGA4003026004	CUP WARMER BACK SIDE - 4 UNITS <i>CUP WARMER BACK SIDE - 4 UNITS</i>
	19		WGA4003024000	CUP WARMER LEFT SIDE <i>CUP WARMER LEFT SIDE</i>
	20		WGA5001029000	SELF-T.SCREWS 4.0X16 WN 1411-KA40X16 <i>SELF-T.SCREWS 4.0X16 WN 1411-KA40X16</i>
	21		11012226	FRONT PANEL 2 UNITS UL <i>FRONT PANEL 2 UNITS UL</i>
	21		WGA4003027003	FRONT PANEL - 3 UNITS <i>FRONT PANEL - 3 UNITS</i>
	21		WGA4003027004	SEPARATOR <i>SEPARATOR</i>

Model Machine

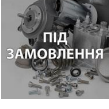
MACSAE064

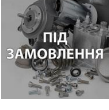









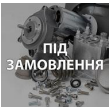

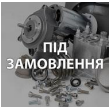

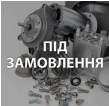





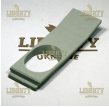





SAECO AROMA SE 200 SILVER

	22		WGA4003019000	WATER LEVEL INDICATOR COVER <i>WATER LEVEL INDICATOR COVER</i>
	23	 ПІД ЗАМОВЛЕННЯ	WGA6003013000	PRESSURE GAUGE COVER <i>PRESSURE GAUGE COVER</i>
	25	 ПІД ЗАМОВЛЕННЯ	WGA4003029002	SEPARATOR <i>SEPARATOR</i>
	25	 ПІД ЗАМОВЛЕННЯ	WGA4003029003	SEPARATOR <i>SEPARATOR</i>
	25	 ПІД ЗАМОВЛЕННЯ	WGA4003029004	SEPARATOR <i>SEPARATOR</i>
	26	 ПІД ЗАМОВЛЕННЯ	DI7981P4.2X16Z	SELF TAPPING GALV. SCREWPLAST <i>SELF TAPPING GALV. SCREWPLAST</i>
	27	 ПІД ЗАМОВЛЕННЯ	DI7981P3.5X16Z	SELF TAPPING GALV. SCREWPLAST <i>SELF TAPPING GALV. SCREWPLAST</i>
	28		11011894	LEFT SILVER SE UPPER FRONT PANEL UL <i>LEFT SILVER SE UPPER FRONT PANEL UL</i>
	28	 ПІД ЗАМОВЛЕННЯ	WGA6003005000	UPPER LEFT FRONT COVER PLATE -BLUE <i>UPPER LEFT FRONT COVER PLATE - BLUE</i>
	28		WGA6003005010	SEPARATOR <i>SEPARATOR</i>
	29	 ПІД ЗАМОВЛЕННЯ	11011907	UPPER MID FRONT SE SILVER UL <i>UPPER MID FRONT SE SILVER UL</i>
	29	 ПІД ЗАМОВЛЕННЯ	WGA6003003000	UPPER MIDDLE FRONT COVER PLATE-BLUE <i>UPPER MIDDLE FRONT COVER PLATE-BLUE</i>
	29		WGA6003003010	UPPER MIDDLE FRONT COVER PLATESILVER <i>UPPER MIDDLE FRONT COVER PLATE SILVER</i>

Model Machine

MACSAE064

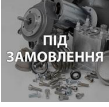











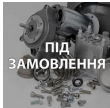

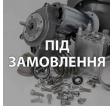

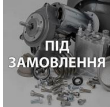





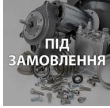

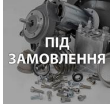

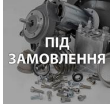
SAECO AROMA SE 200 SILVER

	30		WGA6003003100	UPPER RIGHT FRONT COVER PLATE-BLUE <i>UPPER RIGHT FRONT COVER PLATE -BLUE</i>
	30		WGA6003003110	SEPARATOR <i>SEPARATOR</i>
	31		11011905	FRONTALINO DX SUPER. SE SILVERUL C/SPIA <i>FRONTALINO DX SUPER. SE SILVER UL C/SPIA</i>
	31		WGA6003006100	UPPER RIGHT FRONT COVER PLATEWITH BLUE <i>UPPER RIGHT FRONT COVER PLATE WITH BLUE</i>
	31		WGA6003006110	UPPER DX FRONT COVER PLATE+ LIGHT SILVER <i>UPPER DX FRONT COVER PLATE+ LIGHT SILVER</i>
	32		11011819	FROTHER COVER - NO PAINT UL <i>FROTHER COVER - NO PAINT UL</i>
	32		WGA4003017000	FROTHER COVER - BLACK <i>FROTHER COVER-BLACK</i>
	32		WGA6003022000	SILVER STEAM DISTRIBUTOR COVER <i>SILVER STEAM DISTRIBUTOR COVER</i>
	33		11011818	COFFEE UNIT COVER NO PAINT UL <i>COFFEE UNIT COVER NO PAINT UL</i>
	33		WGA4003015000	COFFEE UNIT COVER - BLACK <i>COPERTURA GRUPPO EROGAZIONE NERA</i>
	33		WGA6003020000	COFFEE UNIT COVER SILVER <i>COFFEE UNIT COVER SILVER</i>
	34		11011908	HOT WATER SPOUT COVER - NO PAINT UL <i>HOT WATER SPOUT COVER - NO PAINT UL</i>
	34		WGA4003016000	HOT WATER SPOUT COVER - BLACK <i>HOT WATER SPOUT COVER - BLACK</i>
	34		WGA6003021000	HOT WATER SPOUT COVER SILVER <i>HOT WATER SPOUT COVER SILVER</i>

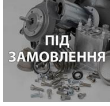
Model Machine

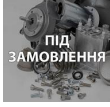
MACSAE064

SAECO AROMA SE 200 SILVER

	35		WGA6003011000	CHROME SAECO LOGO <i>LOGO SAECO CROMATO</i>
	36		WGA4001033002	RING NUT <i>RING NUT</i>
	36		WGA4001033003	RING NUT <i>RING NUT</i>
	36		WGA4001033004	RING NUT <i>RING NUT</i>
	37		WGA4003028002	LOWER TRAY - 2 UNITS <i>LOWER TRAY - 2 UNITS</i>
	37		WGA4003028003	LOWER TRAY - 3 UNITS <i>LOWER TRAY - 3 UNITS</i>
	37		WGA4003028004	SEPARATOR <i>SEPARATOR</i>
	38		11011898	LOWER SILVER SWITCH FRONT PANEL UL <i>LOWER SILVER SWITCH FRONT PANEL UL</i>
	38		WGA8001084030	ASS.FRONT.LOWERINTERR.BLUE <i>ASS.FRONT.LOWERINTERR.BLUE</i>
	38		WGA8001084040	ASS.FRONT.LOWERINTERR.SILVER <i>ASS.FRONT.LOWERINTERR.SILVER</i>
	39		11011900	LOWER SILVER FRONT PANEL UL <i>LOWER SILVER FRONT PANEL UL</i>
	39		WGA8001081030	BLUE LOWER FRONT <i>BLUE LOWER FRONT</i>
	39		WGA8001081040	SILVER LOWER FRONT <i>SILVER LOWER FRONT</i>
	40		WGA8001083030	ASS.FRONT.LOWERBLUE CONTADOSI <i>ASS.FRONT.LOWERBLUE CONTADOSI</i>

Model Machine

MACSAE064

SAECO AROMA SE 200 SILVER



40

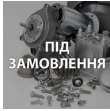

WGA8001083040

DOSE-COUNTER SILVER LOWER FRONT
DOSE-COUNTER SILVER LOWER FRONT



41

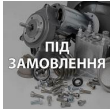

11012211

SIDE PROTECTION CSA
SIDE PROTECTION CSA

Model Machine

MACSAE064

SAECO AROMA SE 200 SILVER

MACSAE064.T.0002

TAVOLA NR. 2 - ARTICOLO SAECO AROMA SE 200 SILVER

(CARROZZERIA AROMA SM)

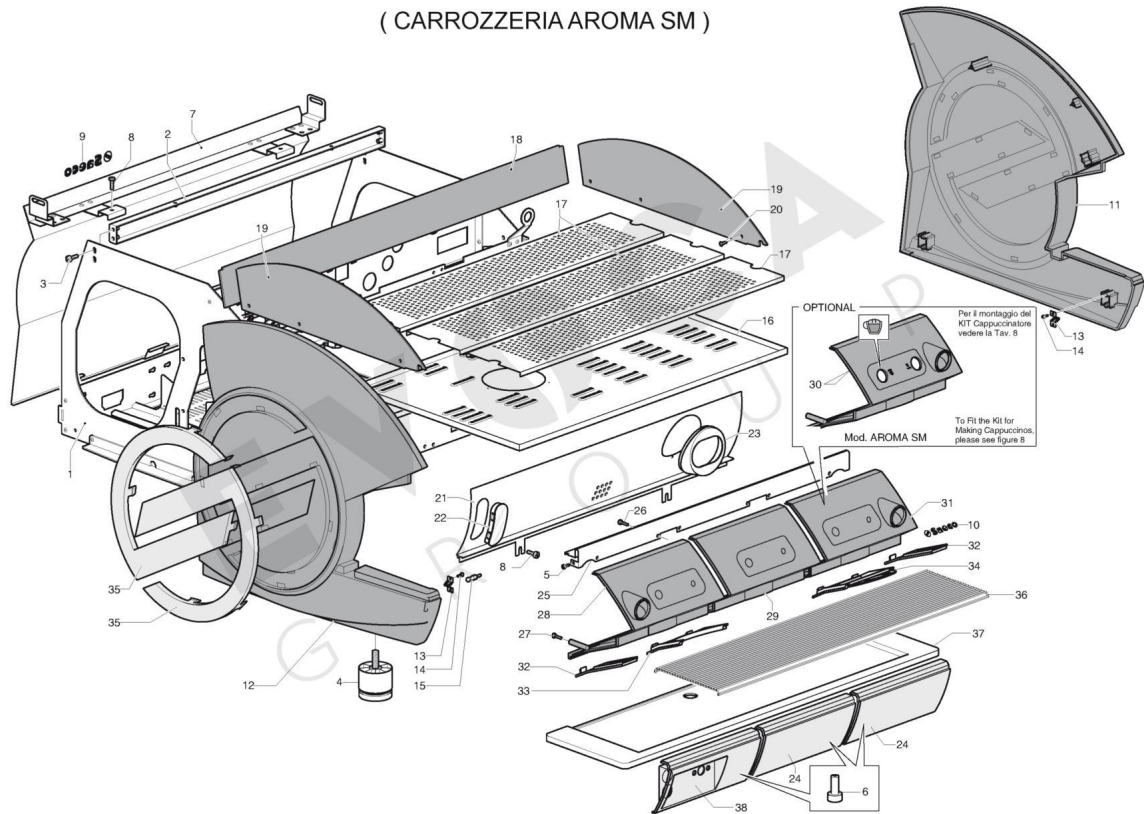

Model Machine

MACSAE064

SAECO AROMA SE 200 SILVER

Web Pos. Foto Item - Replace by Description



Press - CTRL + CLICK go to item in a new window

Натисніть - Ctrl + права кнопка миші щоб відкрити запчастину в новому вікні



1

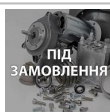

11011944

FRAME ASS. 2 HEADS UL
FRAME ASS. 2 HEADS UL



1

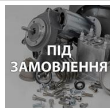

8003011003

FRAME UNIT 3 HEADS
FRAME UNIT 3 HEADS



1

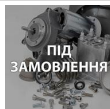

8003011004

FRAME UNIT 4 HEADS
FRAME UNIT 4 HEADS



2

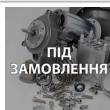

WGA8001006002

TOP REAR CROSS-BRACE 2 HEAD
TOP REAR CROSS-BRACE 2 HEAD



2

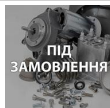

WGA8001006003

TOP REAR CROSS-BRACE 3 HEAD
TOP REAR CROSS-BRACE 3 HEAD



2

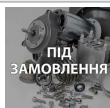

WGA8001006004

TOP REAR CROSS-BRACE 4 HEAD
TOP REAR CROSS-BRACE 4 HEAD



3

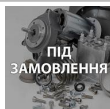

WGADI7986-5X14Z

SCREWS M 5X14 GALVANISED (DIN7985/U)
SCREWS M 5X14 GALVANISED (DIN7985/U)



4



WGA5011001000

STAINLESS STEEL FOOT
PIEDINO ACCIAIO INOX



5



129573402

SCREW TAPT M4X10 DIN 7985 GALV
SCREW TAPT M4X10 DIN 7985 GALV



6

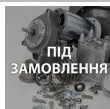

WGA4001157000

INSERT EXTRACTION TOOL
INSERT EXTRACTION TOOL



7

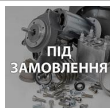

8003005014

SILVER 4 HEADS BACK
SILVER 4 HEADS BACK



7

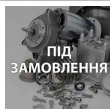

WGA8003005002

COMPLETE REAR PANEL - BLUE 2 UNITS
COMPLETE REAR PANEL - BLUE 2 UNITS



7

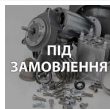











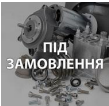

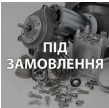









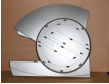



WGA8003005003

COMPLETE REAR PANEL - BLUE 3 UNITS
COMPLETE REAR PANEL - BLUE 3 UNITS

Model Machine

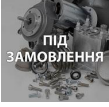
MACSAE064

















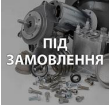







SAECO AROMA SE 200 SILVER

	7		WGA8003005004	BLUE 4 HEADS BACK <i>BLUE 4 HEADS BACK</i>
	7		WGA8003005012	COMPLETE REAR PANEL SILVER 2 UNITS <i>CHIUSURA POST COMPLETA SILVER 2GR</i>
	7		WGA8003005013	COMPLETE REAR PANEL SILVER 3 UNITS <i>COMPLETE REAR PANEL SILVER 3 UNITS</i>
	8		WGADI7986-5X10I	SCREWS M 5X10 ST.STEEL (DIN7985/UNI) <i>SCREWS M 5X10 ST.STEEL (DIN7985/UNI)</i>
	9		1037.012	SAECO TRADEMARK - LENGTH 150 <i>SAECO TRADEMARK - LENGTH 150</i>
	10		1037.014	SAECO L.54 LOGO <i>SAECO L.54 LOGO</i>
	11		11011881	RIGHT SIDE SILVER UL <i>RIGHT SIDE SILVER UL</i>
	11		11022358	RIGHT SIDE BLUE UL <i>RIGHT SIDE BLUE UL</i>
	12		11011883	LEFT SIDE SILVER UL <i>LEFT SIDE SILVER UL</i>
	12		11022355	LEFT SIDE BLUE UL <i>LEFT SIDE BLUE UL</i>
	13		WGA5001004000	SNAP FITTING SPRING <i>SNAP FITTING SPRING</i>
	14		DI7981P3.5X13Z	SELF TAPPING GALV. SCREWPLAST <i>SELF TAPPING GALV. SCREWPLAST</i>
	15		WGA5001003000	INSERT FOR SNAP FITTING SPRING <i>INSERT FOR SNAP FITTING SPRING</i>
	16		WGA8001015002	CUP WARMER TRAY - 2 UNITS <i>CUP WARMER TRAY - 2 UNITS</i>

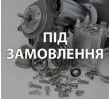
Model Machine

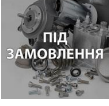
MACSAE064













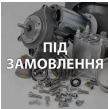

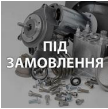

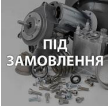

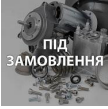

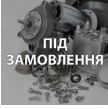

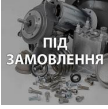

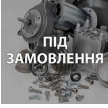
SAECO AROMA SE 200 SILVER

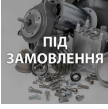
	16		WGA8001015003	COFFEE CONT. ASS.DA 10P BROWN <i>COFFEE CONT. ASS.DA 10P BROWN</i>
	16		WGA8001015004	COFFEE CONT. ASS.DA 10P BROWN <i>COFFEE CONT. ASS.DA 10P BROWN</i>
	17		WGA4001034002	RING NUT <i>RING NUT</i>
	17		WGA4001034003	RING NUT <i>RING NUT</i>
	17		WGA4001034004	RING NUT <i>RING NUT</i>
	18		WGA4003026002	CUP WARMER BACK SIDE - 2 UNITS <i>CUP WARMER BACK SIDE - 2 UNITS</i>
	18		WGA4003026003	CUP WARMER BACK SIDE - 3 UNITS <i>CUP WARMER BACK SIDE - 3 UNITS</i>
	18		WGA4003026004	CUP WARMER BACK SIDE - 4 UNITS <i>CUP WARMER BACK SIDE - 4 UNITS</i>
	19		WGA4003024000	CUP WARMER LEFT SIDE <i>CUP WARMER LEFT SIDE</i>
	20		WGA5001029000	SELF-T.SCREWS 4.0X16 WN 1411-KA40X16 <i>SELF-T.SCREWS 4.0X16 WN 1411-KA40X16</i>
	21		11012226	FRONT PANEL 2 UNITS UL <i>FRONT PANEL 2 UNITS UL</i>
	21		WGA4003027003	FRONT PANEL - 3 UNITS <i>FRONT PANEL - 3 UNITS</i>
	21		WGA4003027004	SEPARATOR <i>SEPARATOR</i>

Model Machine

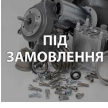
MACSAE064











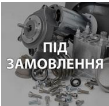

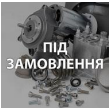













SAECO AROMA SE 200 SILVER

	22		WGA4003019000	WATER LEVEL INDICATOR COVER <i>WATER LEVEL INDICATOR COVER</i>
	23		WGA6003013000	PRESSURE GAUGE COVER <i>PRESSURE GAUGE COVER</i>
	24		WGA8001081030	BLUE LOWER FRONT <i>BLUE LOWER FRONT</i>
	24		WGA8001081040	SILVER LOWER FRONT <i>SILVER LOWER FRONT</i>
	25		WGA4003029002	SEPARATOR <i>SEPARATOR</i>
	25		WGA4003029003	SEPARATOR <i>SEPARATOR</i>
	25		WGA4003029004	SEPARATOR <i>SEPARATOR</i>
	26		DI7981P4.2X16Z	SELF TAPPING GALV. SCREWPLAST <i>SELF TAPPING GALV. SCREWPLAST</i>
	27		DI7981P3.5X16Z	SELF TAPPING GALV. SCREWPLAST <i>SELF TAPPING GALV. SCREWPLAST</i>
	28		WGA6003004000	UPPER LEFT FRONT PANEL BLUE 2GR. <i>UPPER LEFT FRONT PANEL BLUE 2 GR.</i>
	28		WGA6003004010	UPPER LEFT FRONT PANEL SILVER2 GR. <i>UPPER LEFT FRONT PANEL SILVER 2 GR.</i>
	29		WGA6003002000	UPPER MIDDLE FRONT COVER PLATE-BLUE <i>UPPER MIDDLE FRONT COVER PLATE-BLUE</i>
	29		WGA6003002010	UPPER MIDDLE FRONT COVER PLATESILVER <i>UPPER MIDDLE FRONT COVER PLATE SILVER</i>
	30		6003019000	RIGHT BLUE UPPER FRONT PANEL FOR CA <i>RIGHT BLUE UPPER FRONT PANEL FOR CA</i>

Model Machine

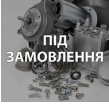
MACSAE064

SAECO AROMA SE 200 SILVER

	30		6003019010	RIGHT SILVER UPPER FRONT PANEL FOR <i>RIGHT SILVER UPPER FRONT PANEL FOR</i>
	31		WGA6003006100	UPPER RIGHT FRONT COVER PLATE WITH BLUE <i>UPPER RIGHT FRONT COVER PLATE WITH BLUE</i>
	31		WGA6003006110	UPPER DX FRONT COVER PLATE+ LIGHT SILVER <i>UPPER DX FRONT COVER PLATE+ LIGHT SILVER</i>
	32		WGA4003017000	FROTHER COVER - BLACK <i>FROTHER COVER-BLACK</i>
	32		WGA6003022000	SILVER STEAM DISTRIBUTOR COVER <i>SILVER STEAM DISTRIBUTOR COVER</i>
	33		WGA4003015000	COFFEE UNIT COVER - BLACK <i>COPERTURA GRUPPO EROGAZIONE NERA</i>
	33		WGA6003020000	COFFEE UNIT COVER SILVER <i>COFFEE UNIT COVER SILVER</i>
	34		WGA4003016000	HOT WATER SPOUT COVER - BLACK <i>HOT WATER SPOUT COVER - BLACK</i>
	34		WGA6003021000	HOT WATER SPOUT COVER SILVER <i>HOT WATER SPOUT COVER SILVER</i>
	35		WGA6003011000	CHROME SAECO LOGO <i>LOGO SAECO CROMATO</i>
	36		WGA4001033002	RING NUT <i>RING NUT</i>
	36		WGA4001033003	RING NUT <i>RING NUT</i>
	36		WGA4001033004	RING NUT <i>RING NUT</i>
	37		WGA4003028002	LOWER TRAY - 2 UNITS <i>LOWER TRAY - 2 UNITS</i>

Model Machine

MACSAE064

SAECO AROMA SE 200 SILVER



37

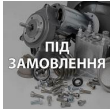

WGA4003028003

LOWER TRAY - 3 UNITS
LOWER TRAY - 3 UNITS



37

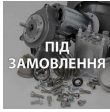

WGA4003028004

SEPARATOR
SEPARATOR



38

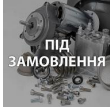

WGA8001084030

ASS.FRONT.LOWERINTERR.BLUE
ASS.FRONT.LOWERINTERR.BLUE



38



WGA8001084040

ASS.FRONT.LOWERINTERR.SILVER
ASS.FRONT.LOWERINTERR.SILVER

(CALDAIA - GRUPPO - LIVELLO)

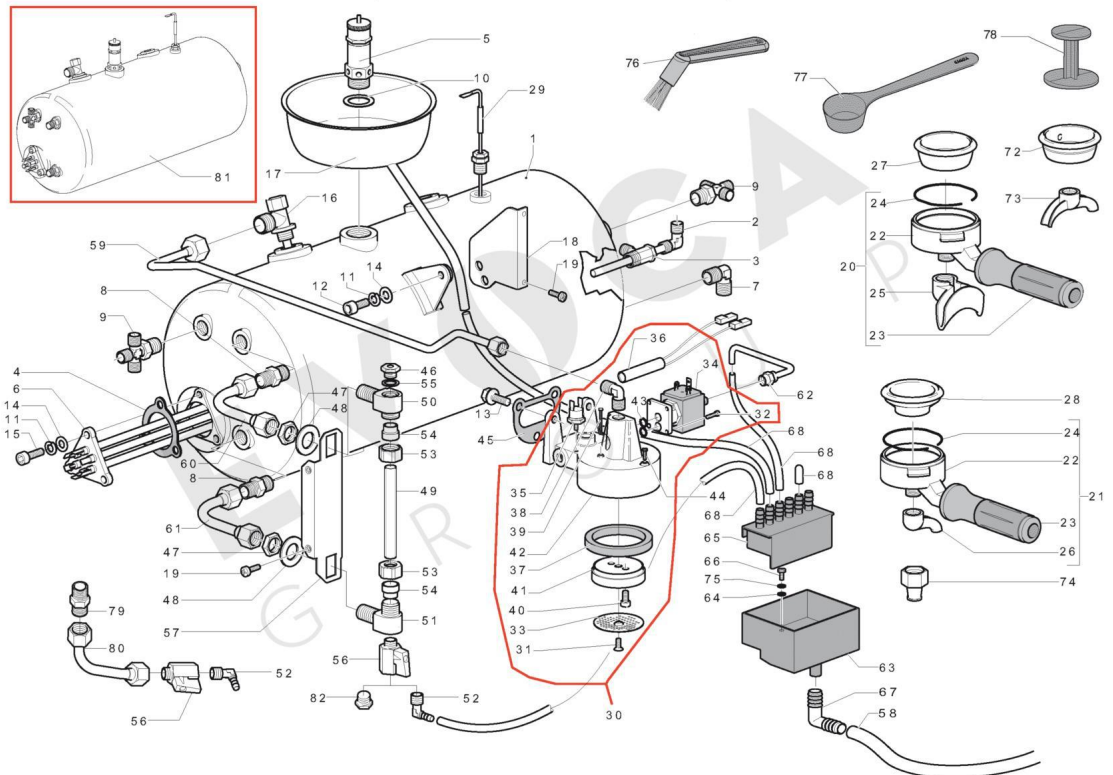

Model Machine

MACSAE064

SAECO AROMA SE 200 SILVER

Web Pos. Foto Item - Replace by Description



Press - CTRL + CLICK go to item in a new window

Натисніть - Ctrl + права кнопка миші щоб відкрити запчастину в новому вікні



1

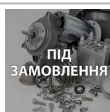

11013249

BOILER CASING GE-GD 2GR.
BOILER CASING GE-GD 2GR.



1

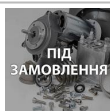

11013260

BOILER CASING GE-GD 3GR.
BOILER CASING GE-GD 3GR.



1

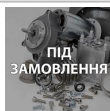

WGA8001022002

COMPLETE BOILER - 2 UNITS
COMPLETE BOILER - 2 UNITS



1

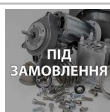

WGA8001022003

COMPLETE BOILER - 3 UNITS
COMPLETE BOILER - 3 UNITS



1

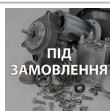

WGA8001022004

SEPARATOR
SEPARATOR



2

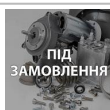

WGACA0492

WATER MIXER COUPLING
RACCORDO MISCELATORE ACQUA



3



WGACA0493/A

WATER MIXER DRAW-OFF
PESCANTE MISCELATORE ACQUA



4



4027001000

RESISTOR GASKET REINZ
GUARNIZIONE PER FLANGIA RESISTENZA



5



12001203

SAFETY VALVE ASME D10
SAFETY VALVE ASME D10



5



WGADM1380/003

ISPEL SAFETY VALVE
VALVOLA SIC.CALD.ITALIA (1,8) CN10-CN10



6



11003362

HEAT ELEM.220/240V 4000/4760W GAGGIA 2GR
HEAT ELEM.220/240V 4000/4760W GAGGIA 2GR



6

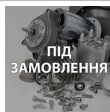

11003363

HEAT ELEM.220/240V 5000/5950W 3GR.GAGGIA
HEAT ELEM.220/240V 5000/5950W 3GR.GAGGIA



6













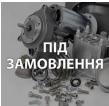

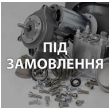













11003364

HEAT ELEM.220/240V 6000/7140W 4GR.GAGGIA
HEAT ELEM.220/240V 6000/7140W 4GR.GAGGIA

Model Machine

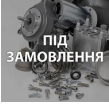
MACSAE064























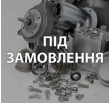

SAECO AROMA SE 200 SILVER

	7		WGANRC10/024	ELBOW COUPLING 3/8 <i>ELBOW COUPLING 3/8</i>
	8		WGANRC11/001	DOUBLE CONNECTION 3/8"M.CI.-3/8" <i>DOUBLE CONNECTION 3/8"M.CI.-3/8"</i>
	9		WGANRC23/003	4-WAY COUPLING 3/8-1/4-1/4-1/4 <i>4-WAY COUPLING 3/8-1/4-1/4-1/4</i>
	10		UN1734-160	FLAT WASHER D.16 BRASS <i>FLAT WASHER D.16 BRASS</i>
	11		WGAUN1751-8Z	RING NUTUNI1751 <i>RING NUT</i>
	12		UN5931-8X16Z	8X16 GALV. SCREW <i>8X16 GALV. SCREW</i>
	13		WGADI6921-8X16Z	SCREWS M 8X16 GALVANISED <i>SCREWS M 8X16 GALVANISED</i>
	14		WGAUN6592-8Z	NUT 8,4X16 UNI6592 ZNP <i>NUT</i>
	15		WGAUN5931-8X25I	8X25 S.S. CAMOPI3 <i>8X25 S.S. SCREW</i>
	16		WGA8001010000	UPPER WATER DRAW-OFF UNIT <i>UPPER WATER DRAW-OFF UNIT</i>
	17		WGA8001023000	CONDENSATION BOX <i>CONDENSATION BOX</i>
	18		WGA8001008000	BOILER TANK SUPPORT BRACKET <i>BOILER TANK SUPPORT BRACKET</i>
	19		WGADI7986-5X14Z	SCREWS M 5X14 GALVANISED (DIN7985/U) <i>SCREWS M 5X14 GALVANISED (DIN7985/U)</i>
	20		WGA8001060000	COMPLETE 2-CUP FILTER UNIT <i>ASS.PORTAFILTRO A 2 VIE RAL7021</i>

Model Machine

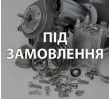
MACSAE064











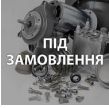



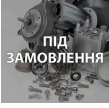



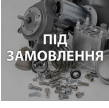

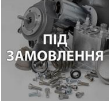

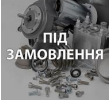

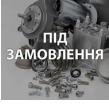
SAECO AROMA SE 200 SILVER

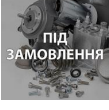
	21		WGA8001059000	COMPLETE 1-CUP FILTER UNIT <i>COMPLETE 1-CUP FILTER UNIT</i>
	22		WGA26G0104	FILTER HOLDER CUP <i>FILTER HOLDER CUP</i>
	23		WGA8001061000	FILTER HANDLE <i>FILTER HANDLE</i>
	24		WGA26G0075	FILTER HOLDER SPRING <i>FILTER HOLDER SPRING</i>
	25		WGA6001023000	2-CUP SPOUT <i>2-CUP SPOUT</i>
	26		WGAAS0146/CL	1-CUP SPOUTNG <i>1-CUP SPOUTNG</i>
	27		WGANF08/005/B	2-CUP FILTER 12-14 GRAMS <i>2-CUP FILTER 12-14 GRAMS</i>
	28		WGANF08/002/B	1-CUP FILTER - 6 GRAMS <i>1-CUP FILTER - 6 GRAMS</i>
	28		WGANF08/004/B	1-CUP FILTER - 7 GRAMS <i>FILTRO A 1 TAZZA 6-7 GR.</i>
	29		WGADM1935	AUTOMATIC LEVEL SENSOR <i>AUTOMATIC LEVEL SENSOR</i>
	30		11012280	V 240 PARKER UNIT UL <i>V 240 PARKER UNIT UL</i>
	30		WGA8001026010	V 230 UNIT <i>V 230 PARKER UNIT</i>
	31		WGADI0964-5X8I	M.5 X 8 STAINLESS STEEL SCREW <i>M.5 X 8 STAINLESS STEEL SCREW</i>

Model Machine

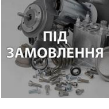
MACSAE064











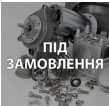

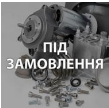













SAECO AROMA SE 200 SILVER

	32		WGAUN5931-4X12I	SCREWS M 4X12 ST.STEEL UNI5931 SCREWS M 4X12 ST.STEEL
	33		WGADM0269	OUTFLOW DISPERSAL PLATE DOCGETTA
	34		12001187	SOLENOID VALVE V 240/60HZ UL SOLENOID VALVE V 240/60HZ UL
	34		WGADM0647	SOLENOID VALVE V 230 HZ 50-60 SOLENOID VALVE V 230 HZ 50-60
	35		WGADM1561	OUTFLOW HEAD THERMOSTAT T 103°C OUTFLOW HEAD THERMOSTAT T 103°C
	36		11012527	OUTFLOW HEAD HEATING ELEMENT OUTFLOW HEAD HEATING ELEMENT
	36		WGADM2125/01	OUTFLOW HEAD HEATING ELEMENT SIST.A CARTUCCIA 80W 240V
	37		WGANG01/001/B	FILTER UNIT GASKET GUARNIZIONE SOTTOCOPPA (8,5)
	37		WGANG01/002	SEAL SEAL
	37		WGANG01/005	SEAL SEAL
	38		8001099000	UNION ELBOW 1/4"M.-1/4"M.-W/OR UNION ELBOW 1/4 M.-1/4 M.-W/OR
	39		WGAUN1336-2X25Z	RING NUT RING NUT
	40		WGAUN5931-6X10I	БОЛТ 6X10 S.S. SCREW
	41		WGA16G1002	FILTER HOLDER PLATE PORTADOCGETTA

Model Machine

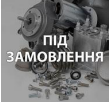
MACSAE064

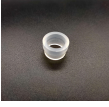





















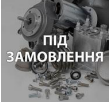

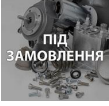
SAECO AROMA SE 200 SILVER

	42		WGA6001015000	OUTFLOW HEAD BODY <i>OUTFLOW HEAD BODY</i>
	43		12000540	O-RING 2025 VITON FDA 70 SH <i>O-RING 2025 VITON FDA 70 SH</i>
	44		WGADI7986-4X10I	SS SCREW M 4X10 <i>SS SCREW M 4X10</i>
	45		WGA4001084000	UNIT SPACE <i>UNIT SPACE</i>
	46		WGADM2186	ANTI-SUCTION VALVE <i>VALVOLA ANTIDEPRESSIONE</i>
	47		WGAND01/005	NUT 3/8 <i>NUT 3/8</i>
	48		WGAUN6592-17Z	NUT <i>NUT</i>
	49		WGA4001060000	LIVEL GLASS <i>LIVEL GLASS</i>
	50		WGA4001072000	UPPER BODY LEVEL <i>UPPER BODY LEVEL</i>
	51		WGA4001073000	LOWER BODY LEVEL <i>LOWER BODY LEVEL</i>
	52		WGA4001074000	1/4" ELBOW HOSE FITTING <i>"1/4" ELBOW HOSE FITTING"</i>
	53		WGA4001075000	LEVEL CUP <i>LEVEL CUP</i>
	54		WGA4001076000	SEAL <i>SEAL</i>
	55		WGA4001077000	SEAL <i>GUARNIZIONE P.T.F.E. 13,5X18X2X2</i>

Model Machine

MACSAE064











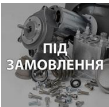

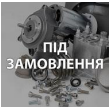

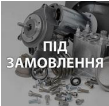











SAECO AROMA SE 200 SILVER

	56		WGA5001016000	WATER LEVEL INDICATOR DRAIN VALVE <i>WATER LEVEL INDICATOR DRAIN VALVE</i>
	57	 ПІД ЗАМОВЛЕННЯ	11010044	ASS.SUPPORT CLOSED LEVEL <i>ASS.SUPPORT CLOSED LEVEL</i>
	57	 ПІД ЗАМОВЛЕННЯ	WGA8001005000	MOTOR SUPPORT <i>MOTOR SUPPORT</i>
	58		WGA5001024000	DRAIN HOSE <i>DRAIN HOSE</i>
	59	 ПІД ЗАМОВЛЕННЯ	WGA8001042000	TUBING FROM BOILER TO OUTFLOWHEAD <i>TUBING FROM BOILER TO OUTFLOW HEAD</i>
	60		WGA8003002000	UPPER WATER LEVEL INDICATOR TUBING <i>UPPER WATER LEVEL INDICATOR TUBING</i>
	61	 ПІД ЗАМОВЛЕННЯ	WGA8003001000	LOWER WATER LEVEL INDICATOR TUBING <i>LOWER WATER LEVEL INDICATOR TUBING</i>
	62	 ПІД ЗАМОВЛЕННЯ	WGA8001050000	SOLENOID VALVE DEPRESSURIZING TUBE <i>SOLENOID VALVE DEPRESSURIZING TUBE</i>
	63		WGA4001097000	DRAIN TANK <i>DRAIN TANK</i>
	64	 LIBERTY UKRAINE	WGA4009036000	GASKET FOR DISCHARGE BASIN <i>GASKET FOR DISCHARGE BASIN</i>
	65		WGA4001099000	DRAIN TANK COVER <i>DRAIN TANK COVER</i>
	66	 ПІД ЗАМОВЛЕННЯ	DI7986-6X16I	SCREWS M 6X16 ST.STEEL (DIN7985/UNI) <i>SCREWS M 6X16 ST.STEEL (DIN7985/UNI)</i>
	67		WGA5001021000	DRAIN TANK DISCHARGE COUPLING <i>DRAIN TANK DISCHARGE COUPLING</i>

Model Machine

MACSAE064

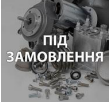
SAECO AROMA SE 200 SILVER

	68		WGADM2106/015	***SILICONE TUBE 5X10 L.650MM <i>TUBE SL-NE 5X9X650 SILIC.</i>
	71		WGADM1908	SILICONE CUP <i>SILICONE CUP</i>
	72		WGANF08/009/B	DOUBLE POD FOR 2-CUP FILTER <i>DOUBLE POD FOR 2-CUP FILTER</i>
	73		WGA6301004010	2-WAY SPOUT CHROME <i>2-WAY SPOUT CHROME</i>
	74		WGA26G0112	06501 SPOUT 1 CUP STRAIGHT <i>06501 SPOUT 1 CUP STRAIGHT</i>
	75		WGADI9021-6I	IMPULSE COUNTER COMESTERO 6 NOS. <i>IMPULSE COUNTER COMESTERO 6 NOS.</i>
	76		WGA5001033000	ЩІТКА ДЛЯ ЧИЩЕННЯ ГРУПИ <i>HEADS CLEANING BRUSH</i>
	77		WGADM1017	MEASURE <i>MEASURE</i>
	78		WGA2PR/1	SEPARATOR <i>SEPARATOR</i>
	79		WGANRC11/000	DUAL COUPLING 3/8" <i>DUAL COUPLING 3/8"</i>
	80		11013265	EXTENSION DUMP TUBE <i>EXTENSION DUMP TUBE</i>
	81		11013261	BOILER ASSEMBLY 2GR GE-GD <i>BOILER ASSEMBLY 2GR GE-GD</i>
	81		11013262	BOILER ASSEMBLY 3GR GE-GD <i>BOILER ASSEMBLY 3GR GE-GD</i>
	81		8001074002	BOILER UNIT W. WASH. 2 HDGE-GDV 23 <i>BOILER UNIT W. WASH. 2 HDGE-GD V 23</i>

Model Machine

MACSAE064

SAECO AROMA SE 200 SILVER



81

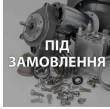

8001074003

BOILER UNIT W. WASH. 3 HDGE-GDV 23

BOILER UNIT W. WASH. 3 HDGE-GD V 23



82

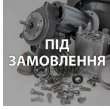

WGACA0472

PLUG 1/4 GAS

PLUG 1/4 GAS

Model Machine

MACSAE064

SAECO AROMA SE 200 SILVER

MACSAE064.T.0004

TAVOLA NR. 4 - ARTICOLO SAECO AROMA SE 200 SILVER

(MOTOPOMPA-RUBINETTO CARICO)

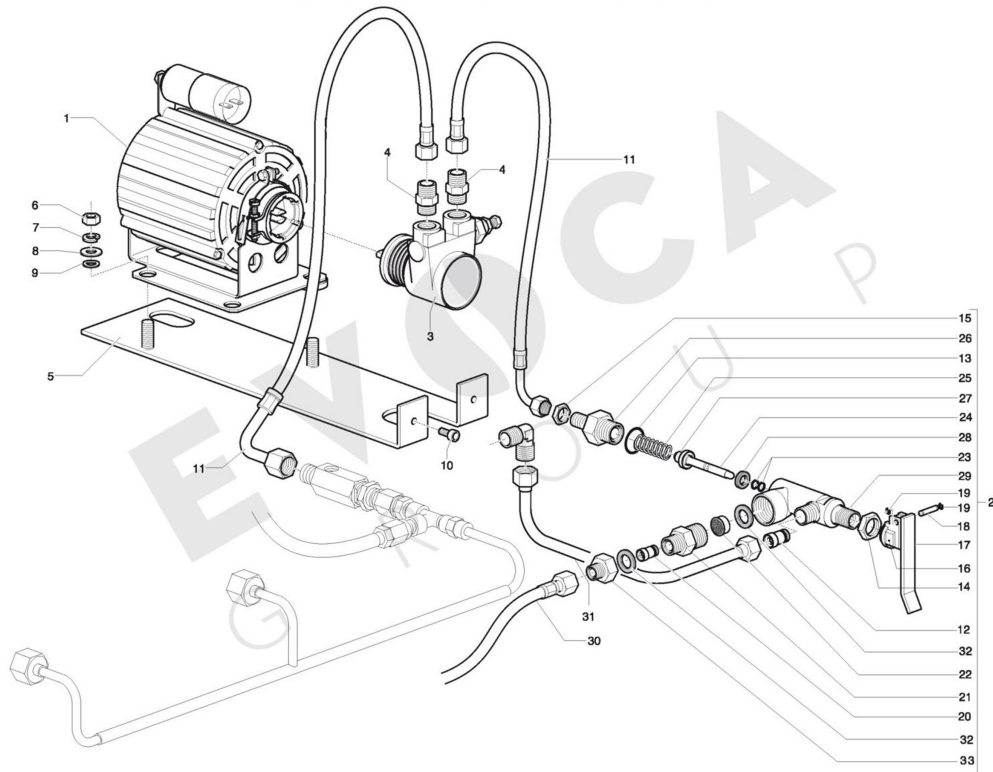

Model Machine

MACSAE064

SAECO AROMA SE 200 SILVER

Web Pos. Foto Item - Replace by Description



Press - CTRL + CLICK go to item in a new window

Натисніть - Ctrl + права кнопка миші щоб відкрити запчастину в новому вікні



1

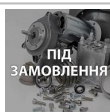

11010116

MOTOR 230V 60HZ UL
MOTOR 230V 60HZ UL



1

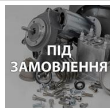

WGA5001017000

MOTOR V 230 HZ 50-60
MOTOR V 230 HZ 50-60



2

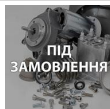

WGA8001033000

COMPLETE FILL TAP UNIT
COMPLETE FILL TAP UNIT



3



DM0217/002/PG

PROCON PUMP 8BAR/100L NSF
PROCON PUMP 8BAR/100L NSF



3

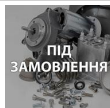

DM0217/003/PG

PUMP PROCON 8BAR/178L NSF
PUMP PROCON 8BAR/178L NSF



4

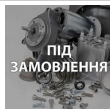

WGANRC11/037

COUPLING 3/8-1/4"
COUPLING 3/8-1/4



5

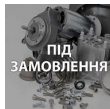

WGA8001009000

COMPLETE PUMP MOUNT
COMPLETE PUMP MOUNT



6

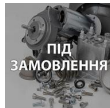

WGAUN5587-8Z

8 GALV. NUT
8 GALV. NUT



7



WGAUN1751-8Z

RING NUTUNI1751
RING NUT



8



WGAUN6593-8Z

NUT
NUT



9

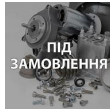

WGAUN6592-8Z

NUT 8,4X16 UNI6592 ZNP
NUT



10

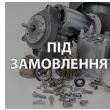

WGAUN5931-6X10Z

6X10 GALV. SCREW
6X10 GALV. SCREW



11





WGADM1608

HOSE
HOSE

Model Machine

MACSAE064











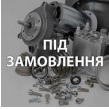



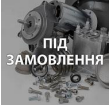

SAECO AROMA SE 200 SILVER

	12		WGA8001072000	NON RETURN VALVE <i>NON RETURN VALVE</i>
	13		WGADM0041/066	O-RING 3068 NBR 80 SH <i>GASKET OR 3068</i>
	14		WGAND01/005	NUT 3/8 <i>NUT 3/8</i>
	15		WGAND01/016	1/4" GAS NUT <i>1/4" GAS NUT</i>
	16		RB0642	LOADING VALVE CAP <i>LOADING VALVE CAP</i>
	17		WGARB0843	LEVER TAP LOAD <i>LEVER TAP LOAD</i>
	18		WGARB0844	PIN FOR LEVER LOAD <i>PIN FOR LEVER LOAD</i>
	19		UN7434-3.2B	BURNISHED D. 3.2 BENZING RING <i>BURNISHED D. 3.2 BENZING RING</i>
	20		12001141	ЗВОРОТНІЙ КЛАПАН OF15 31.0006.0 <i>ONE-WAY VALVE OF15 31.0006.0</i>
	21		11010367	VALVE COUPLING 3/4-M <i>VALVE COUPLING 3/4-M</i>
	22		WGA5001005000	WATER INTAKE FILTER <i>WATER INTAKE FILTER</i>
	23		WGADM0041/032	O-RING 2015 VITON 70 SH <i>WGADM0041/032</i>
	24		WGA4001088000	RING NUT <i>RING NUT</i>
	25		WGA4001089000	BUTTON TAP SPRING <i>BUTTON TAP SPRING</i>

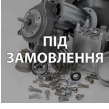
Model Machine

MACSAE064

SAECO AROMA SE 200 SILVER

	26		WGA4001090000	BUTTON TAP CONNECTION <i>BUTTON TAP CONNECTION</i>
	27		WGA4001091000	BUTTON TAP GASKET <i>BUTTON TAP GASKET</i>
	28		WGA4001092000	SEAL <i>SEAL</i>
	29		WGA6001016000	COCK BODY <i>COCK BODY</i>
	30		WGADM1209	STAINLESS STEEL FILL TAP TUBE <i>STAINLESS STEEL FILL TAP TUBE</i>
	31		WGA8001048000	TUBE FROM FILL TAP TO BOILER <i>TUBE FROM FILL TAP TO BOILER</i>
	32		WGA4001094000	ГУМОВА ПРОКЛАДКА <i>GASKET</i>
	33		11010368	COUPLING <i>COUPLING</i>
	33		WGA4001093000	FILTER COUPLING <i>FILTER COUPLING</i>



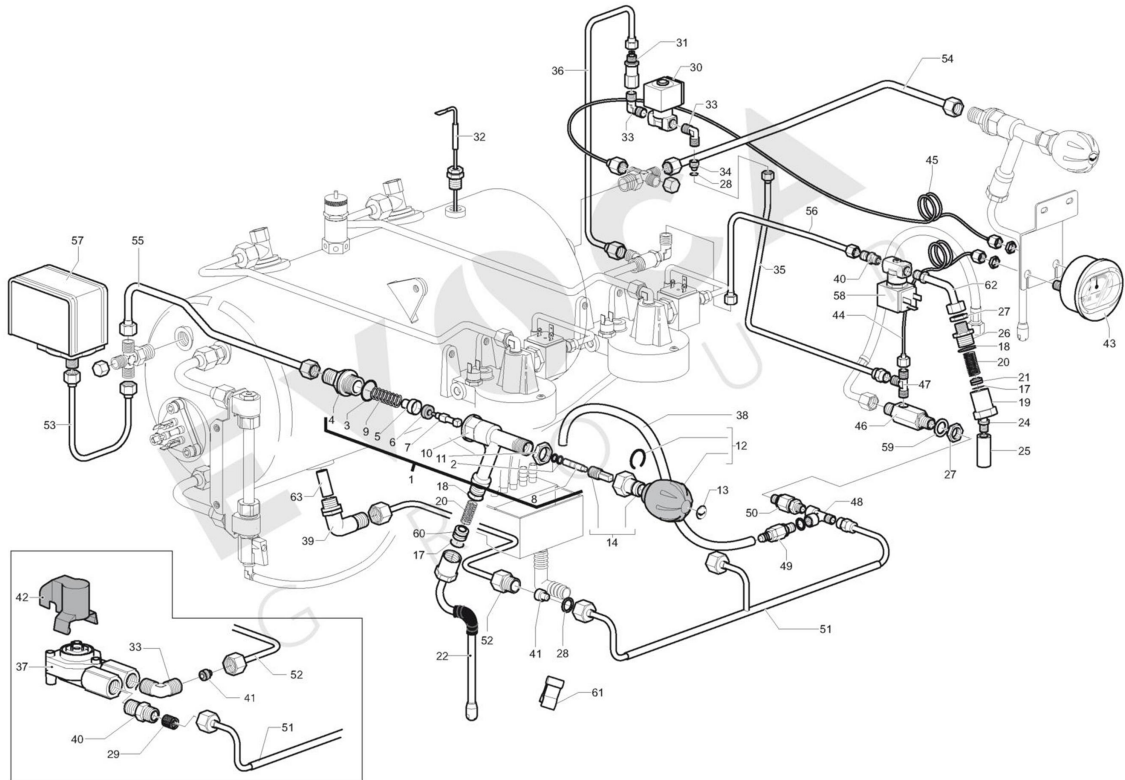













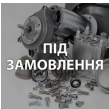

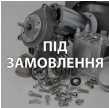







(RUBINETTERIA-CARICO AUTOM.)

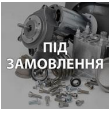

Model Machine

MACSAE064













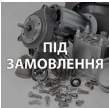













SAECO AROMA SE 200 SILVER

Web	Pos.	Foto	Item - Replace by	Description
				<i>Press - CTRL + CLICK go to item in a new window Натисніть - Ctrl + права кнопка миші щоб відкрити запчастину в новому вікні</i>
	1		WGA8001027000	COMPLETE VALVE CORPO RUBINETTO COMPLETO
	2		WGADM0041/032	O-RING 2015 VITON 70 SH WGADM0041/032
	3		WGADM0041/063	O-RING 128 RED SILICONE GASKET OR 128
	4		WGARB0606/01	"ПЕРЕХІДНИК 3/8" (13-2256) COUPLING 3/8"
	5		WGARB0708	PRESSURE-CONTAINING MEMBER PRESSURE-CONTAINING MEMBER
	6		WGARB0709	PRESSURE-CONTAINING MEMBER GASKET GUARNIZIONE OTTURATORE
	7		WGARB0710	PRESSURE-CONTAINING MEMBER ROD PRESSURE-CONTAINING MEMBER ROD
	8		WGARB0711	СЕРЦЕВИНА КРАНУ ПОДАЧИ ВОДИ CONTROL ROD
	9		WGARB0712	SPRING SPRING
	10		WGA6001002000	КОРПУС КРАНА SAECO GAGGIA VALVE SHELL
	11		WGAND01/005	NUT 3/8 NUT 3/8
	12		WGA8001028000	KNOB ASSEMBLY KNOB ASSEMBLY
	13		WGADM0794/003	ADHESIVE STEAM NAMEPLATE ADHESIVE STEAM NAMEPLATE

Model Machine

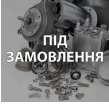
MACSAE064























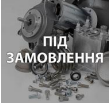

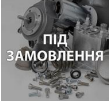
SAECO AROMA SE 200 SILVER

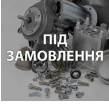
	14		WGARB0866/A	ASS.CAP <i>ASSIEME CALOTTA ASTA VOLANTINO</i>
	17		WGADM0041/106	ГУМОВИЙ УЩІЛЮВАЧ 115 PHILIPS SAECO 996530063896 <i>GASKET OR 115</i>
	18		WGADM0041/107	ГУМОВИЙ УЩІЛЬНЮВАЧ OR 2062 SAECO GAGGIA <i>GASKET OR 2062</i>
	19		WGARB0881	COFFEE CONT. ASS.DA 10P BROWN <i>COFFEE CONT. ASS.DA 10P BROWN</i>
	20		WGARB0882	SPRING FOR CAP WATER-DRAWING <i>SPRING FOR CAP WATER-DRAWING</i>
	21		WGARB0902	SEAL CUP <i>SEAL CUP</i>
	22		11011247	TUBE VAPORIZER TEFLON <i>TUBE VAPORIZER TEFLON</i>
	22		11011271	HIGH TUBE VAPORIZER TEFLON <i>HIGH TUBE VAPORIZER TEFLON</i>
	22		WGA8003013000	FROTHER TUBE ASSEMBLY <i>FROTHER TUBE ASSEMBLY</i>
	24		WGARB0880	ARTICULATION PIPE WATER <i>ARTICULATION PIPE WATER</i>
	25		RB0697/01	PIPE DRAWING-WATER <i>PIPE DRAWING-WATER</i>
	26		WGA4001078000	CONNECTION WATER TUBE <i>CONNECTION WATER TUBE</i>
	27		WGAND01/016	1/4" GAS NUT <i>1/4" GAS NUT</i>
	28		WGADM0041/031	OR 2018 VITON 70 SH <i>OR 2018 IN VITON 70SH</i>

Model Machine

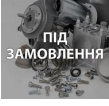
MACSAE064











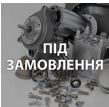















SAECO AROMA SE 200 SILVER

	29		WGADM0962/001	FILTER <i>FILTER</i>
	30		12001188	2-WAY SOLENOID VALVE V.240/60D.1,5 UL <i>2-WAY SOLENOID VALVE V.240/60 D.1,5 UL</i>
	30		DM1197/220/5060	2-WAY SOLENOID VALVE V.220-50/ <i>2-WAY SOLENOID VALVE V.220-50/</i>
	31		WGADM1232/001	ONE-WAY VALVE <i>ONE-WAY VALVE</i>
	32		WGADM1935	AUTOMATIC LEVEL SENSOR <i>AUTOMATIC LEVEL SENSOR</i>
	33		8001099000	UNION ELBOW 1/4"M.-1/4"M.-W/OR <i>UNION ELBOW 1/4 M.-1/4 M.-W/OR</i>
	34		WGA26G0113	NOZZLE D.1 <i>GIGLEUR D.1</i>
	35		WGA8001031000	TUBE FOR PUMP <i>TUBE FOR PUMP</i>
	36		WGA8001032000	TUBE FOR BOILER ELECTROVALVE <i>TUBE FOR BOILER ELECTROVALVE</i>
	37		11013052	ДОЗАТОР ВОДИ M5000 <i>BLACK COFFEE DOSE ADJUSTMENT GEAR M5000</i>
	38		WGADM2106/003	***SILICONE TUBE 5X10 L.250MM <i>SILICONE TUBE SL-NE 5X9X250</i>
	38		WGADM2106/010	***SILICONE TUBE 5X10 L.490MM <i>3 UNITS</i>
	38		WGADM2106/015	***SILICONE TUBE 5X10 L.650MM <i>TUBE SL-NE 5X9X650 SILIC.</i>

Model Machine

MACSAE064











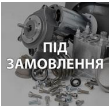

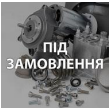













SAECO AROMA SE 200 SILVER

	39		11014164	UPTAKE PIPE FITTING <i>UPTAKE PIPE FITTING</i>
	39		WGA8001011000	LOWER WATER DRAW-OFF UNIT <i>LOWER WATER DRAW-OFF UNIT</i>
	40		8001100000	UNION STRAIGHT 1/4"M.-1/4"M.-W/OR <i>UNION STRAIGHT 1/4 M.-1/4 M.-W/OR</i>
	41		WGA26G0074/01	NOZZLE D.0,6 <i>GIGLEUR D.0,6</i>
	42		WGA26G0076/01	PROTECTION DOSER <i>PROTECTION DOSER</i>
	43		WGA5001018000	МАНОМЕТР З ПОДВІЙНОЮ ШКАЛОЮ ВИМІРУ ТИСКУ <i>MANOMETRO DOPPIA SCALA</i>
	44		WGA5001019000	1/8-1/8 <i>1/8-1/8</i>
	45		WGA5001020000	CAPILLARY TUBE 1/8-1/4 <i>CAPILLARE MANOMETRO 1/8-1/4" SAECO</i>
	46		WGA4001059000	DOSER CASING <i>RACCORDO VALVOLA NON RITORNO</i>
	47		WGA5001006000	ТРІЙНИК З РІЗЬБОЮ 1/8 <i>T-COUPLING 1/8</i>
	48		WGA5001007000	T-COUPLING 1/8 M/F <i>RACCORDO A T 1/8 M/F</i>
	49		WGA5001014000	ADJUSTABLE EXPANSION VALVE <i>ADJUSTABLE EXPANSION VALVE</i>
	50		WGA5001015000	ONE-WAY VALVE <i>ONE-WAY VALVE</i>
	51		WGA8001039002	ПОСТАВЛЯЮЧИЙ КОЛЕКТОР <i>FEEDER MANIFOLD - 2 UNITS</i>

Model Machine

MACSAE064









SAECO AROMA SE 200 SILVER

	51		WGA8001039003	FEEDER MANIFOLD - 3 UNITS <i>FEEDER MANIFOLD - 3 UNITS</i>
	51		WGA8001039004	DOSER CASING <i>DOSER CASING</i>
	52		11013922	TUBE CONNECTION BOILER <i>TUBE CONNECTION BOILER</i>
	52		11013923	TUBE CONNECTION BOILER <i>TUBE CONNECTION BOILER</i>
	52		WGA8001040000	BOILER <i>BOILER</i>
	52		WGA8001041000	TUBE FROM FEEDER MANIFOLD TO BOILER <i>TUBE FROM FEEDER MANIFOLD TO BOILER</i>
	53		8001045010	TUBE FOR BOILER <i>TUBE FOR BOILER</i>
	54		WGA8001046000	UNIT <i>UNIT</i>
	55		WGA8001047000	UNIT <i>UNIT</i>
	56		WGA8001049000	TUBE <i>TUBO DA MISCEL.A ELETTR.PRELIEVO</i>
	57		12001274	TRIBOELECTRIC PRESSURE SWITCHUL <i>TRIBOELECTRIC PRESSURE SWITCH UL</i>
	58		12001189	2-WAY SOLENOID VALVE 24060 <i>2-WAY SOLENOID VALVE 24060</i>
	58		WGADM2115	2-WAY SOLENOID VALVE V230 HZ50/60 <i>2-WAY SOLENOID VALVE V230 HZ50/60</i>
	59		WGANR01/073	ШАЙБА 14 X 20 X 1,5 <i>WASHER 14 X 20 X 1,5</i>

Model Machine

MACSAE064

SAECO AROMA SE 200 SILVER

	60		11006809	SEAL CUP <i>SEAL CUP</i>
	61		WGA4003033000	GRIP STEAM TUBE <i>GRIP STEAM TUBE</i>
	62		8001025000	TUBE FROM SOLENOID VALVE TO CONNEC <i>TUBE FROM SOLENOID VALVE TO CONNEC</i>
	63		11013371	INJECTOR TUBE 6X8 L.65 <i>INJECTOR TUBE 6X8 L.65</i>

(PARTI ELETTRICHE AROMA SE)

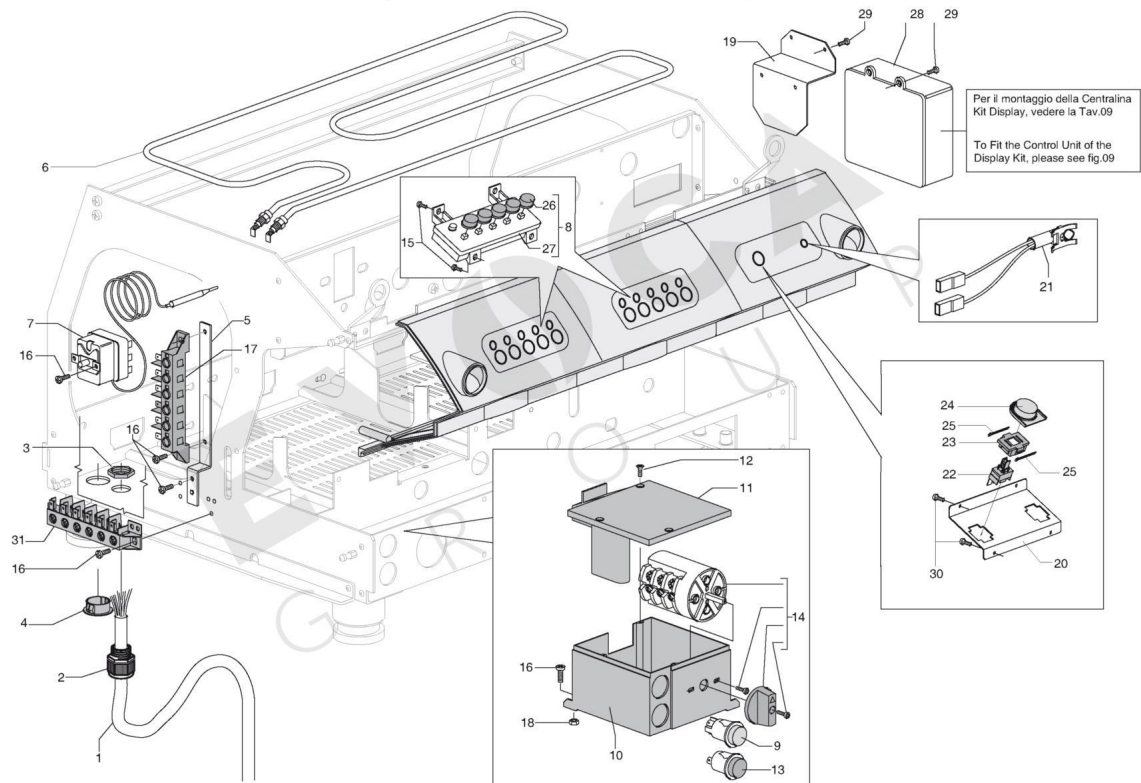

Model Machine

MACSAE064

SAECO AROMA SE 200 SILVER

Web Pos. Foto Item - Replace by Description



Press - CTRL + CLICK go to item in a new window











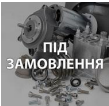

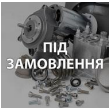













Натисніть - Ctrl + права кнопка миші щоб відкрити запчастину в новому вікні

	1		11002043	POWER CABLE 3 X 10AWG <i>POWER CABLE 3 X 10AWG</i>
	1		WGA5001023000	IMPULSE COUNTER COMESTERO 6 NOS. <i>IMPULSE COUNTER COMESTERO 6 NOS.</i>
	2		12001221	CABLE CLAMP PG21UL <i>CABLE CLAMP PG21UL</i>
	3		12001222	RING NUT PG21 UL <i>RING NUT PG21 UL</i>
	4		5009004000	PLUG FAST POINT 5780 AA01 <i>PLUG FAST POINT 5780 AA01</i>
	5		WGA4001014000	DOSER CASING <i>DOSER CASING</i>
	6		ES9190.283.00A	HEAT ELEMENT 230V 2GR. GEGD GAGGIA <i>HEAT ELEMENT 230V 2GR. GEGD GAGGIA</i>
	6		ES9190.284.00A	HEATING ELEMENT 30V 3GR. GEGDGAGGIA <i>HEATING ELEMENT 30V 3GR. GEGD GAGGIA</i>
	6		WGA5001011004	DOSER CASING <i>DOSER CASING</i>
	7		12001204	THERMOSTAT <i>THERMOSTAT</i>
	7		5024007000	THERMOSTAT 170°C <i>THERMOSTAT 170°C</i>
	8		WGA8003007000	IMPULSE COUNTER COMESTERO 6 NOS. <i>PULSANTIERA COMPLETA SE</i>
	9		WGADM2104	ПЕРЕМИКАЧ ПІДІГРІВАЧА ЧАШОК <i>CUP WARMER SWITCH</i>

Model Machine

MACSAE064



















SAECO AROMA SE 200 SILVER

	10		WGA4001104000	MAIN SWITCH BOX <i>MAIN SWITCH BOX</i>
	11		WGA4001105000	CUP SWITCH BOX <i>CUP SWITCH BOX</i>
	12		DI7982P3.5X13I	SELF TAPPING S.S.SCREWPLAST 3, <i>SELF TAPPING S.S.SCREWPLAST 3,</i>
	13		WGA5001012000	ON LIGHT <i>ON LIGHT</i>
	14		WGADM1944	4-WAY SWITCH 30 A <i>4-WAY SWITCH 30 A</i>
	15		DI7981-3.5X9.5I	SELF TAPPING S.S.SCREW 3,5X9,5 <i>SELF TAPPING S.S.SCREW 3,5X9,5</i>
	16		WGADI7986-4X10Z	SCREW M.4 X 10 <i>SCREW M.4 X 10</i>
	17		WGADM1931	6-SLOT TERMINAL BLOCK <i>6-SLOT TERMINAL BLOCK</i>
	18		WGAUN5587-4Z	M 4 GALVANISED HEX NUT <i>M 4 GALVANISED HEX NUT</i>
	19		WGA4001013000	SUPPORT SQUARE GEARCASE <i>SUPPORT SQUARE GEARCASE</i>
	20		WGA4003023000	SWITCH SQUARE <i>SWITCH SQUARE</i>
	21		WGA5001010000	SIGNALLER COFFE V230 <i>SIGNALLER COFFE V230</i>
	22		WGA5001009000	WATER UPTAKE CONTROL BUTTON <i>WATER UPTAKE CONTROL BUTTON</i>
	23		WGA4001080000	SWITCH ADAPTER <i>SWITCH ADAPTER</i>

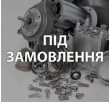
Model Machine

MACSAE064

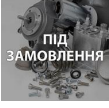
SAECO AROMA SE 200 SILVER

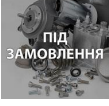
	24		WGA6003012000	SWITCH CHROME BUTTON <i>SWITCH CHROME BUTTON</i>
	25		IS1234-3.2X32Z	GALV.SPLIT PIN D.3.2X32 <i>GALV.SPLIT PIN D.3.2X32</i>
	26		WGA6003016000	CHROM.KEYPAD BUTTON <i>CHROM.KEYPAD BUTTON</i>
	27		8003023000	KEYPAD GROUP W/O KEYS SE <i>KEYPAD GROUP W/O KEYS SE</i>
	28		DM2182/02/230	3D5 MAESTRO 2GRCTZD ELECTRONICCONT <i>3D5 MAESTRO 2GRCTZD ELECTRONIC CONT</i>
	28		DM2182/03/230	ELECTR.J-BOX 3GRCTZD 3D5 MAESTRO <i>ELECTR.J-BOX 3GRCTZD 3D5 MAESTRO</i>
	28		DM2182/04/230	ELECTR.J-BOX 4GRCTZD 4D5 MAESTRO <i>ELECTR.J-BOX 4GRCTZD 4D5 MAESTRO</i>
	29		129573402	SCREW TAPT M4X10 DIN 7985 GALV <i>SCREW TAPT M4X10 DIN 7985 GALV</i>
	30		DI7981P2.9X6.5I	STAIN STEEL 2,9X6,5THREAD SCRE <i>STAIN STEEL 2,9X6,5THREAD SCRE</i>
	31		WGADM1930	6-POLE TERM. BOARD FV122 B X C <i>6-POLE TERM. BOARD FV122 B X C</i>

(PARTI ELETTRICHE AROMA SM)

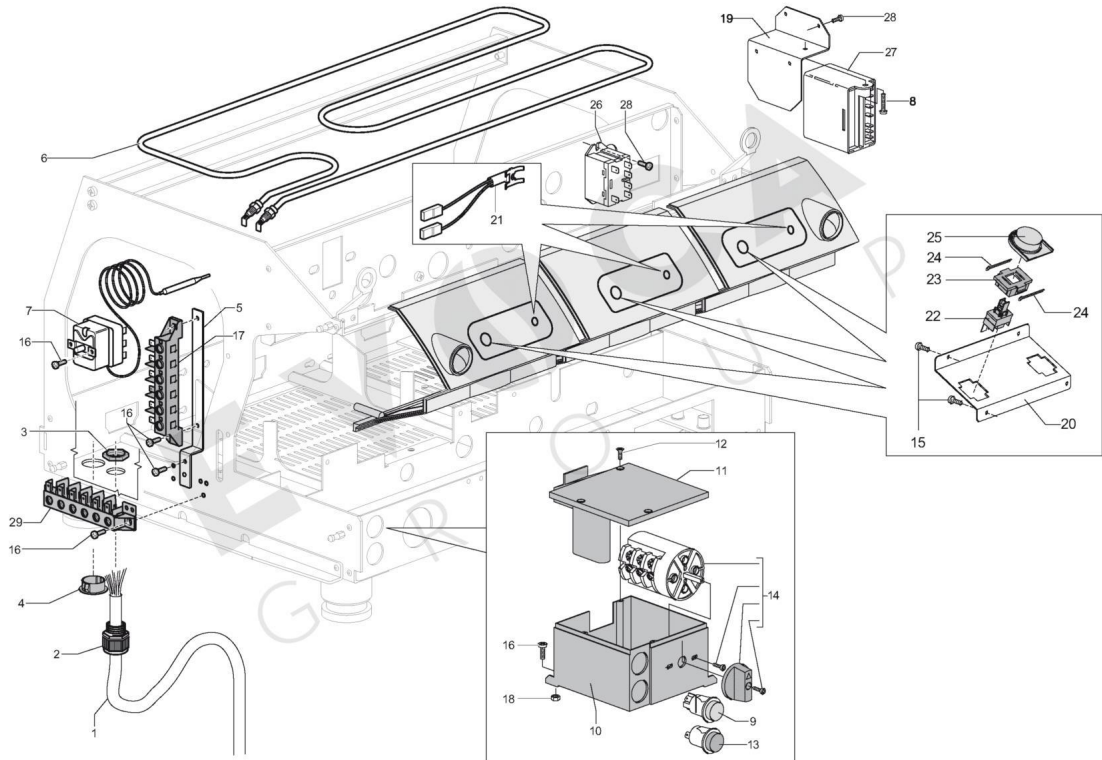

Model Machine

MACSAE064

SAECO AROMA SE 200 SILVER

Web Pos. Foto Item - Replace by Description



Press - CTRL + CLICK go to item in a new window

Натисніть - Ctrl + права кнопка миші щоб відкрити запчастину в новому вікні



1

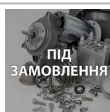

CE0517

POWER CORD 5 X 2.5
POWER CORD 5 X 2.5



2

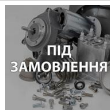

12001221

CABLE CLAMP PG21UL
CABLE CLAMP PG21UL



3



12001222

RING NUT PG21 UL
RING NUT PG21 UL



4

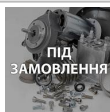

5009004000

PLUG FAST POINT 5780 AA01
PLUG FAST POINT 5780 AA01



5

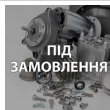

WGA4001014000

DOSER CASING
DOSER CASING



6

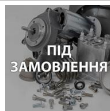

ES9190.283.00A

HEAT ELEMENT 230V 2GR. GEGD GAGGIA
HEAT ELEMENT 230V 2GR. GEGD GAGGIA



6

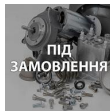

ES9190.284.00A

HEATING ELEMENT 30V 3GR. GEGDGAGGIA
HEATING ELEMENT 30V 3GR. GEGD GAGGIA



6



WGA5001011004

DOSER CASING
DOSER CASING



7

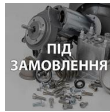

5024007000

THERMOSTAT 170°C
THERMOSTAT 170°C



8

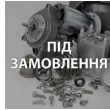

WGAUN8112-4X25Z

SCREWS TRILOBATE M 4X25 GALVANISED
SCREWS TRILOBATE M 4X25 GALVANISED



9

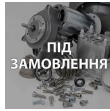

WGADM2104

ПЕРЕМИКАЧ ПІДІГРІВАЧА ЧАШОК
CUP WARMER SWITCH



10

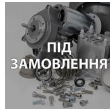

WGA4001104000

MAIN SWITCH BOX
MAIN SWITCH BOX



11

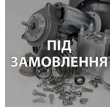











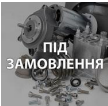

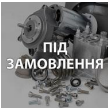



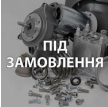





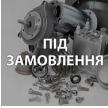

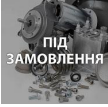

WGA4001105000

CUP SWITCH BOX
CUP SWITCH BOX

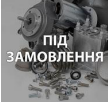
Model Machine

MACSAE064









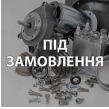

SAECO AROMA SE 200 SILVER

	12	 ПІД ЗАМОВЛЕННЯ	DI7982P3.5X13I	SELF TAPPING S.S.SCREWPLAST 3, <i>SELF TAPPING S.S.SCREWPLAST 3,</i>
	13	 ПІД ЗАМОВЛЕННЯ	WGA5001012000	ON LIGHT <i>ON LIGHT</i>
	14		WGADM1944	4-WAY SWITCH 30 A <i>4-WAY SWITCH 30 A</i>
	15	 ПІД ЗАМОВЛЕННЯ	DI7981-3.5X9.5I	SELF TAPPING S.S.SCREW 3,5X9,5 <i>SELF TAPPING S.S.SCREW 3,5X9,5</i>
	16	 ПІД ЗАМОВЛЕННЯ	WGADI7986-4X10Z	SCREW M.4 X 10 <i>SCREW M.4 X 10</i>
	17	 ПІД ЗАМОВЛЕННЯ	WGADM1931	6-SLOT TERMINAL BLOCK <i>6-SLOT TERMINAL BLOCK</i>
	18	 ПІД ЗАМОВЛЕННЯ	WGAUN5587-4Z	M 4 GALVANISED HEX NUT <i>M 4 GALVANISED HEX NUT</i>
	19	 ПІД ЗАМОВЛЕННЯ	WGA4001013000	SUPPORT SQUARE GEARCASE <i>SUPPORT SQUARE GEARCASE</i>
	20	 ПІД ЗАМОВЛЕННЯ	WGA4003023000	SWITCH SQUARE <i>SWITCH SQUARE</i>
	21		WGA5001010000	SIGNALLER COFFE V230 <i>SIGNALLER COFFE V230</i>
	22	 ПІД ЗАМОВЛЕННЯ	12001020	SWITCH SIGNAL LUX COD.L52H8M9OUC <i>SWITCH SIGNAL LUX COD.L52H8M9OUC</i>
	22		WGA5001001000	SX AND CENTER <i>INTERRUTTORE CAFF? GE</i>
	22		WGA5302001000	UNIPOLAR SWITCH <i>UNIPOLAR SWITCH</i>
	23		WGA4001080000	SWITCH ADAPTER <i>SWITCH ADAPTER</i>

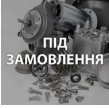
Model Machine

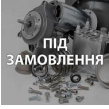
MACSAE064

SAECO AROMA SE 200 SILVER

	24	 ПІД ЗАМОВЛЕННЯ	IS1234-3.2X32Z	GALV.SPLIT PIN D.3.2X32 GALV.SPLIT PIN D.3.2X32
	25	 LIBERTY UKRAINE	WGA6003012000	SWITCH CHROME BUTTON SWITCH CHROME BUTTON
	26	 ПІД ЗАМОВЛЕННЯ	WGADM2122	RELAY V230 RELAY V230
	27	 ПІД ЗАМОВЛЕННЯ	WGADM1940	LEVEL CONTROL UNIT V230 LEVEL CONTROL UNIT V230
	28		129573402	SCREW TAPT M4X10 DIN 7985 GALV SCREW TAPT M4X10 DIN 7985 GALV
	29	 ПІД ЗАМОВЛЕННЯ	WGADM1930	6-POLE TERM. BOARD FV122 B X C 6-POLE TERM. BOARD FV122 B X C



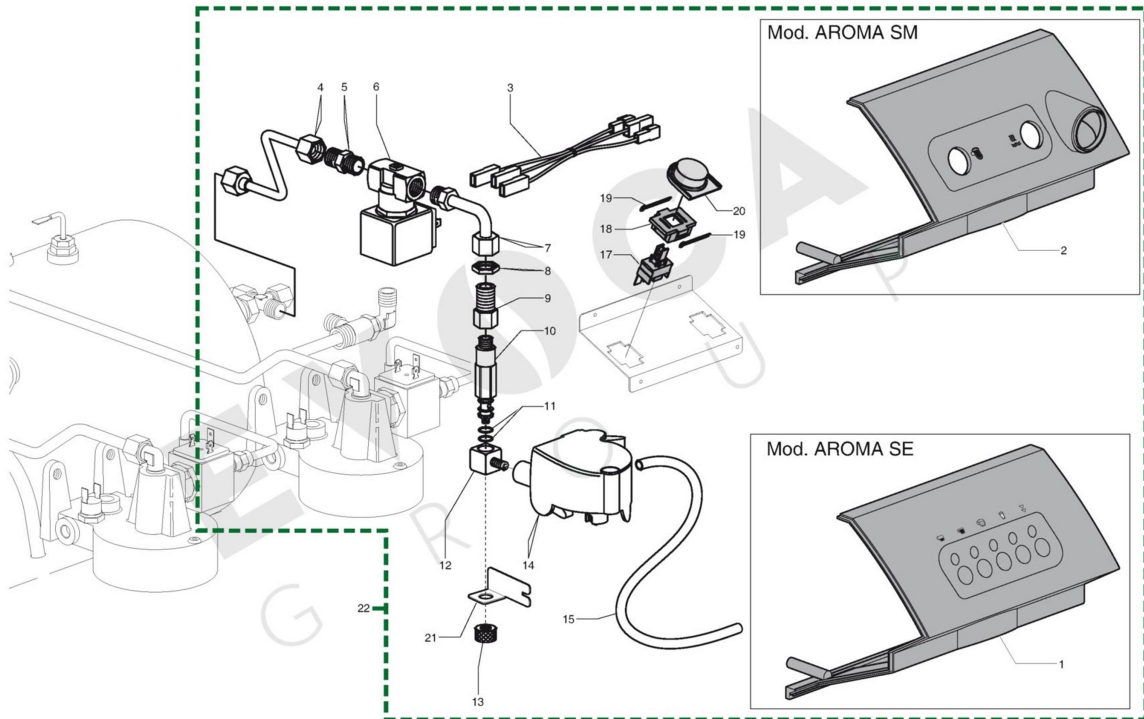









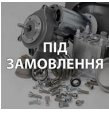

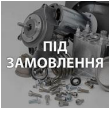

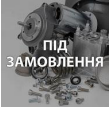

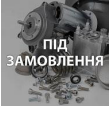

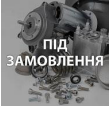

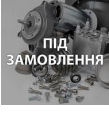



(KIT CAPPUCINATORE)

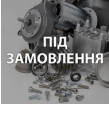

Model Machine

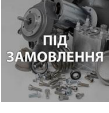
MACSAE064

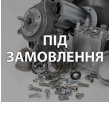









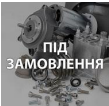

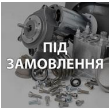













SAECO AROMA SE 200 SILVER

Web	Pos.	Foto	Item - Replace by	Description
				<i>Press - CTRL + CLICK go to item in a new window Натисніть - Ctrl + права кнопка миші щоб відкрити запчастину в новому вікні</i>
	1		WGA6003003100	UPPER RIGHT FRONT COVER PLATE-BLUE <i>UPPER RIGHT FRONT COVER PLATE -BLUE</i>
	1		WGA6003003110	SEPARATOR <i>SEPARATOR</i>
	2		6003019000	RIGHT BLUE UPPER FRONT PANEL FOR CA <i>RIGHT BLUE UPPER FRONT PANEL FOR CA</i>
	2		6003019010	RIGHT SILVER UPPER FRONT PANELFOR <i>RIGHT SILVER UPPER FRONT PANEL FOR</i>
	3		WGA4001124000	FROTHER WIRING <i>FROTHER WIRING</i>
	4		WGA8001057000	TUBE FROM BOILER TO SOLENOID VALVE <i>TUBE FROM BOILER TO SOLENOID VALVE</i>
	5		WGA26G0070/01	FITTING 1/4" <i>RACCORDO 1/4 M.CO.-1/4 M.CI.C/</i>
	6		WGADM2115	2-WAY SOLENOID VALVE V230 HZ50/60 <i>2-WAY SOLENOID VALVE V230 HZ50/60</i>
	7		WGA8001058000	TUBE FROM SOLENOID VALVE TO FROTHER <i>TUBE FROM SOLENOID VALVE TO FROTHER</i>
	8		WGAND01/016	1/4" GAS NUT <i>1/4" GAS NUT</i>
	9		11011255	CAPPUCCINATORE STEAM COUPLING <i>CAPPUCCINATORE STEAM COUPLING</i>
	10		WGA4003001000	FROTHER COUPLING <i>FROTHER COUPLING</i>
	11		WGADM0041/103	O-RING 2031 EPDM 70 SH <i>OR 2031 IN EPDM 70 SH</i>

Model Machine

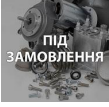
MACSAE064

SAECO AROMA SE 200 SILVER

	12		WGA4001149000	CAPPUCCINO MAKER JOINT <i>CAPPUCCINO MAKER JOINT</i>
	13		11011612	CAP JOINT STOP NUT <i>CAP JOINT STOP NUT</i>
	14		WGA8001056000	BLACK/CHROME CAPPUCCINO MAKER <i>BLACK/CHROME CAPPUCCINO MAKER</i>
	15		WGA4001153000	TUBE SL-TRBF 3,5X6X650 ASPIRATION <i>TUBE SL-TRBF 3,5X6X650 ASPIRATION</i>
	17		WGA5302001000	UNIPOLAR SWITCH <i>UNIPOLAR SWITCH</i>
	18		WGA4001080000	SWITCH ADAPTER <i>SWITCH ADAPTER</i>
	19		IS1234-3.2X32Z	GALV.SPLIT PIN D.3.2X32 <i>GALV.SPLIT PIN D.3.2X32</i>
	20		WGA6003012000	SWITCH CHROME BUTTON <i>SWITCH CHROME BUTTON</i>
	20		WGA6003016000	CHROM.KEYPAD BUTTON <i>CHROM.KEYPAD BUTTON</i>
	21		11011256	CAPPUCCINATORE STEAM NO ROTATION <i>CAPPUCCINATORE STEAM NO ROTATION</i>
	22		0952.R01.650	ACCKIT CAPPUC AROMA SM 2-3-4GRBLU <i>ACCKIT CAPPUC AROMA SM 2-3-4GRBLU</i>
	22		0952.R01.A30	ACCKIT CAPPUC AROMA SM 2-3-4GRSIL <i>ACCKIT CAPPUC AROMA SM 2-3-4GR SIL</i>
	22		0955.R01.650	ACCKIT CAPPUC AROMA SE 2-3-4GRBLU <i>ACCKIT CAPPUC AROMA SE 2-3-4GRBLU</i>
	22		0955.R01.A30	ACCKIT CAPPUC AROMA SE 2-3-4GRSIL <i>ACCKIT CAPPUC AROMA SE 2-3-4GR SIL</i>

Model Machine

MACSAE064

SAECO AROMA SE 200 SILVER

MACSAE064.T.0009

TAVOLA NR. 9 - ARTICOLO SAECO AROMA SE 200 SILVER

(KIT DISPLAY)

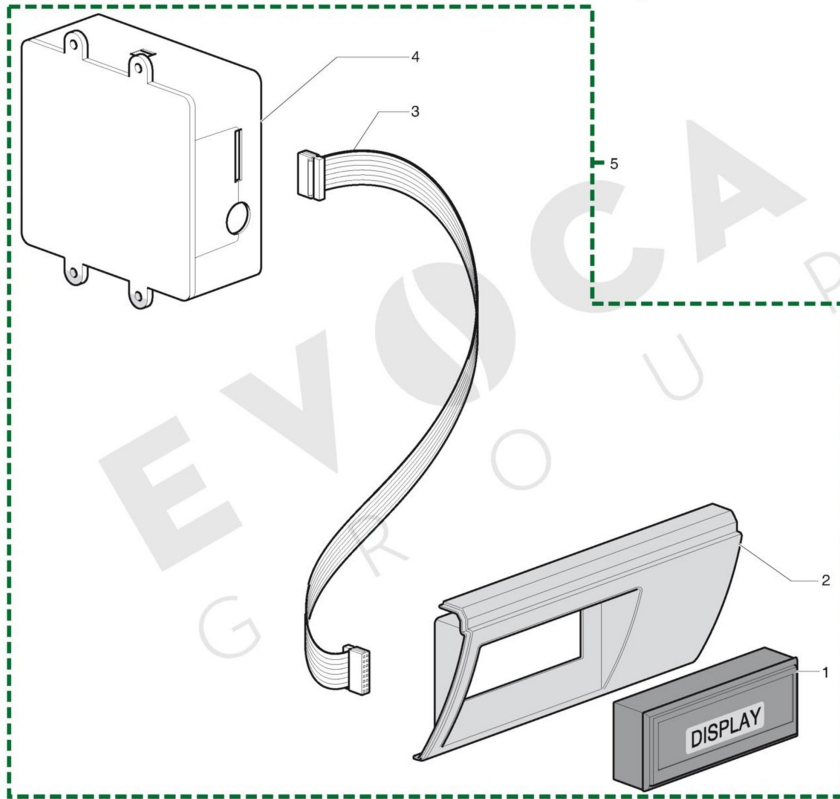

Model Machine

MACSAE064

SAECO AROMA SE 200 SILVER

Web Pos. Foto Item - Replace by Description



Press - CTRL + CLICK go to item in a new window
Натисніть - Ctrl + права кнопка миші щоб відкрити запчастину в новому вікні



1

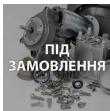

WGADM2194

DISPLAY 3D5
DISPLAY 3D5



2

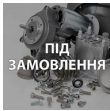

WGA8001083030

ASS.FRONT.LOWERBLUE CONTADOSI
ASS.FRONT.LOWERBLUE CONTADOSI



2

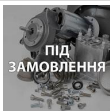

WGA8001083040

DOSE-COUNTER SILVER LOWER FRONT
DOSE-COUNTER SILVER LOWER FRONT



3



WGA4001120000

PUSH-BUTTON PANEL CABLE 650MM
PUSH-BUTTON PANEL CABLE 650MM



4



DM2182/02/230

3D5 MAESTRO 2GRCTZD ELECTRONICCONT
3D5 MAESTRO 2GRCTZD ELECTRONIC CONT



4



DM2182/03/230

ELECTR.J-BOX 3GRCTZD 3D5 MAESTRO
ELECTR.J-BOX 3GRCTZD 3D5 MAESTRO



4

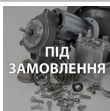

DM2182/04/230

ELECTR.J-BOX 4GRCTZD 4D5 MAESTRO
ELECTR.J-BOX 4GRCTZD 4D5 MAESTRO



5

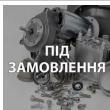

0955.R02.650

ACC KIT DISPLAY AROMA SE 200 BLU
ACC KIT DISPLAY AROMA SE 200 BLU



5

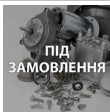

0955.R02.A30

ACC KIT DISPLAY AROMA SE 200 SIL
ACC KIT DISPLAY AROMA SE 200 SIL



5

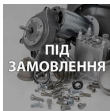

0956.R01.650

ACC KIT DISPLAY AROMA SE 300 BLU
ACC KIT DISPLAY AROMA SE 300 BLU



5

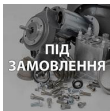

0956.R01.A30

ACC KIT DISPLAY AROMA SE 300 SIL
ACC KIT DISPLAY AROMA SE 300 SIL