

# Model Machine

MACSAE111

SAECO RUBINO 200 чорна (верхня частина)(10003260 )

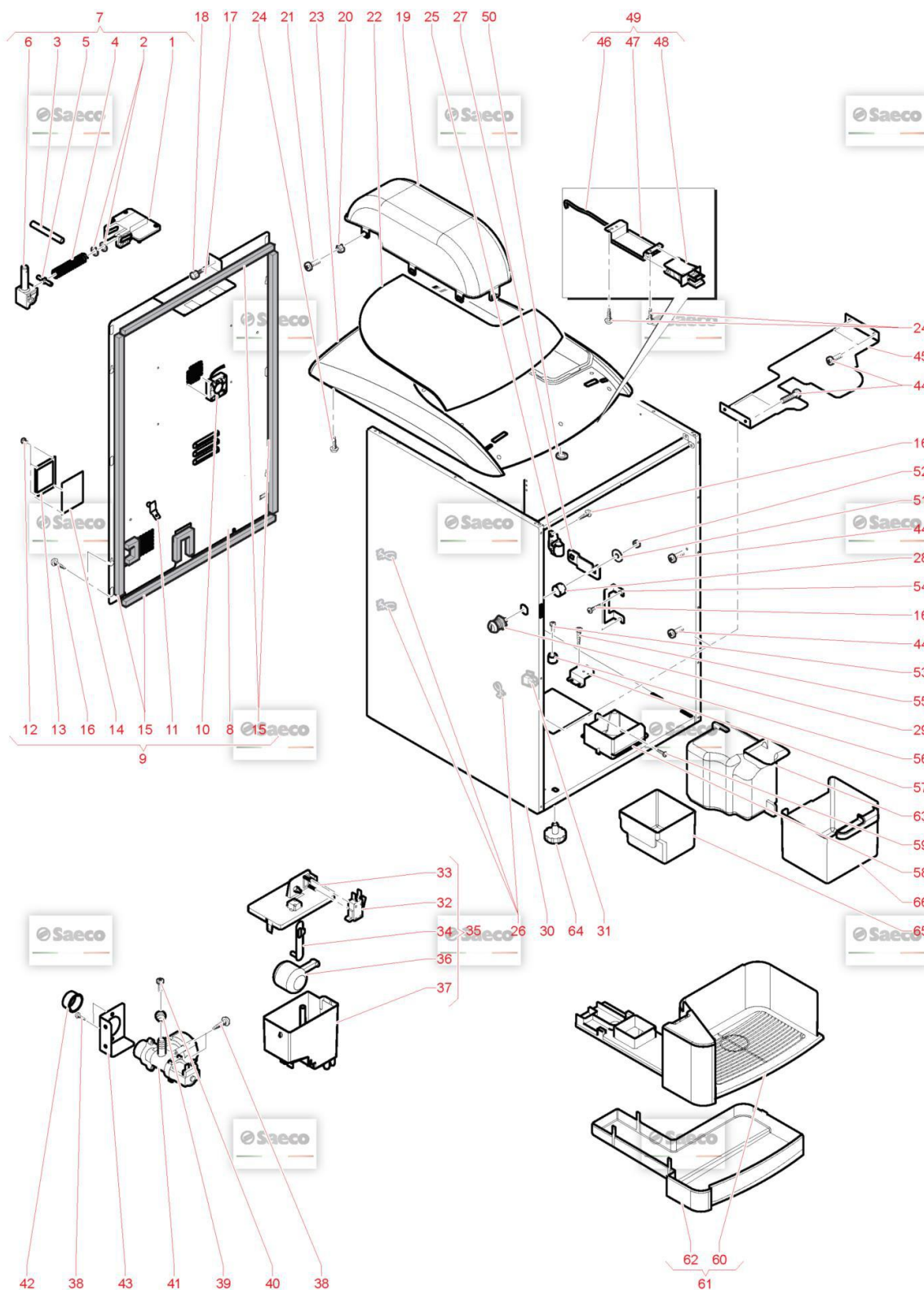











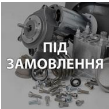

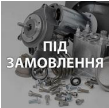

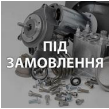

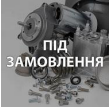



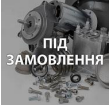

MACSAE111.T.0001

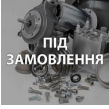

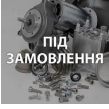
## Model Machine

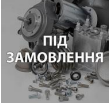
MACSAE111

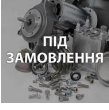

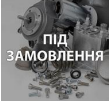







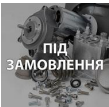

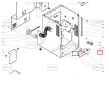

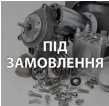











SAECO RUBINO 200 чорна (верхня частина)(10003260 )

Web	Pos.	Foto	Item - Replace by	Description
				<i>Press - CTRL + CLICK go to item in a new window Натисніть - Ctrl + права кнопка миші щоб відкрити запчастину в новому вікні</i>
	1		1813.038.A20	FLANGE FLANGIA
	2		U207.007	PLAIN WASHER 8,4X14 UNI 6592 GA PLAIN WASHER 8,4X14 UNI 6592 GA
	3		1813.036	ROTATION PIN ROTATION PIN
	4		1813.079	SPRING FOR HINGE SPRING FOR HINGE
	5		1813.048.A20	PIN FOR HINGE PIN FOR HINGE
	6		1813.039.A20	HINGE HINGE
	7		1883.A10.A20	ASS.HINGE ASS.CERNIERA MONTATA
	8		11002025	BACKBOARD SG 200 UL BACKBOARD SG 200 UL
	8		1813.226	BACKBOARD BACKBOARD
	9		11001852	ASSEMBLY BACK UL / NAMA ASSEMBLY BACK UL / NAMA
	9		1883.A08.00P	ASS.BACKBOARD SG200 ASS.BACKBOARD SG200
	10		9121.245.00P	FAN 40X40X12,7 VENTILATORE 40X40X12.7 24V

## Model Machine

MACSAE111

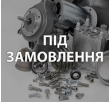









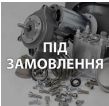

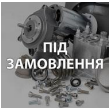













SAECO RUBINO 200 чорна (верхня частина)(10003260 )

	11	 ПІД ЗАМОВЛЕННЯ	NE13.022	COPPER RIVET D.4 WITH TONGUE 6,3 <i>COPPER RIVET D.4 WITH TONGUE 6,3</i>
	12		NF11.015	EXPANSION RIVET D=2,8X8 ALU. <i>RIVETTO AD ESPANS. D=2,9X9 A</i>
	13	 ПІД ЗАМОВЛЕННЯ	11001853	PLATE FOR METALLIC GRATE <i>PLATE FOR METALLIC GRATE</i>
	14	 ПІД ЗАМОВЛЕННЯ	11001854	METALLIC GRATE 1,6MM <i>METALLIC GRATE 1,6MM</i>
	15	 ПІД ЗАМОВЛЕННЯ	1602.160	UPPER VERTICAL INSULATOR FOR DOOR <i>UPPER VERTICAL INSULATOR FOR DOOR</i>
	16	 ПІД ЗАМОВЛЕННЯ	U109.011	SCREW AUT.TCB 3,9X9,5 DIN 7981C <i>SCREW AUT.TCB 3,9X9,5 DIN 7981 C</i>
	17	 ПІД ЗАМОВЛЕННЯ	1813.176	ASS.BOILER SEPARATOR <i>ASS.BOILER SEPARATOR</i>
	18		9111.330	KNURLED MALE HAND BOLT M5 <i>GODRONE MASCHIO M5</i>
	19	 ПІД ЗАМОВЛЕННЯ	11000971	CAP <i>CAP</i>
	19	 ПІД ЗАМОВЛЕННЯ	1813.020.230	UPPER LID ESPRESSO <i>CAPPUCCIO CAMPANA CAFFE'</i>
	20		U324.005	NUT M3 FLANGED INDENTED BASE <i>DADO M3 FLANGIATO BASE DENTELLATA</i>
	21	 ПІД ЗАМОВЛЕННЯ	U044.004	SCREW TSPC M3,0X12 UNI 7688 GALV. <i>SCREW TSPC M3,0X12 UNI 7688 GALV.</i>
	22	 ПІД ЗАМОВЛЕННЯ	11002737	UPPER COVER DOOR RED <i>UPPER COVER DOOR RED</i>
	22	 ПІД ЗАМОВЛЕННЯ	1813.033.770	DOOR COVER <i>DOOR COVER</i>

## Model Machine

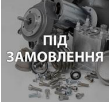
MACSAE111

















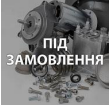





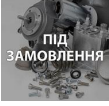

SAECO RUBINO 200 чорна (верхня частина)(10003260 )

	23		<b>11002663</b>	UPPER LID BEIGE <i>COPERCHIO SUPERIORE BEIGE</i>
	23		<b>11002664</b>	UPPER LID UL BEIGE <i>UPPER LID UL BEIGE</i>
	23		<b>11021460</b>	UPPER LID BLACK <i>UPPER LID BLACK</i>
	23		<b>11021461</b>	UPPER LID UL BLACK <i>UPPER LID UL BLACK</i>
	23		<b>1813.019.850</b>	UPPER LID ESPRESSO <i>COPERCHIO SUPERIORE ESPRESSO</i>
	23		<b>1813.302.850</b>	UPPER LID UL <i>UPPER LID UL</i>
	24		<b>U116.006</b>	SCREW AUT.PT TCB 3,5X12 WN 1441 ZNP <i>VITE AUT.PT TCB 3,5X12 WN 1441 ZNP</i>
	25		<b>1813.023.A20</b>	HINGE <i>CERNIERA PALETTIERA</i>
	26		<b>NF11.043</b>	CLIP WITH HOOK <i>CLIP WITH HOOK</i>
	27		<b>1813.105</b>	LEVER FOR LOCK <i>LEVER FOR LOCK</i>
	28		<b>1813.126</b>	SPACER <i>SPACER</i>
	29		<b>11003480</b>	LOCK RIELDA SHORT <i>SERRATURA RIELDA CORTA</i>
	29		<b>NV02.249</b>	LOCK MERONI 3351B21 X DISTRIB. <i>LOCK MERONI 3351B21 X DISTRIB.</i>
	30		<b>11002690</b>	CABINET ASS. SG 200 BEIGE MET. <i>CABINET ASS. SG 200 BEIGE MET.</i>

## Model Machine

MACSAE111











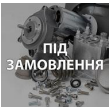

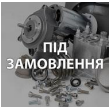

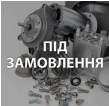











SAECO RUBINO 200 чорна (верхня частина)(10003260 )

	30		<b>11021463</b>	CABINET ASS. SG 200 BLACK <i>CABINET ASS. SG 200 BLACK</i>
	30		<b>1813.001.840</b>	CABINET ASS. SG 200 <i>CABINET ASS. SG 200</i>
	31		<b>12000731</b>	LATCH 2 ROLLERS MOD. 244.01.903 <i>CRICCHETTO A DUE RULLI MOD. 244.01.903</i>
	31		<b>NF11.036</b>	LATCH 2 ROLLERS <i>CRICCHETTO A DUE RULLI</i>
	32		<b>NE05.062</b>	MICROSWITCH + WHEEL <i>MICROINTERRUTTORE C/ROTELLA</i>
	33		<b>9111.623</b>	LID TANK AIR BREAK <i>COPERCHIO X SERBATOIO AIR BREAK</i>
	34		<b>9111.512</b>	LEVER FOR WATER TANK <i>LEVER FOR WATER TANK</i>
	35		<b>1813.A25</b>	ASS. AIR/BREAK ASSEMBLE SG200 <i>ASS. AIR/BREAK ASSEMBLE SG200</i>
	36		<b>9111.508</b>	FLOAT FOR AIR BREAK BOWL <i>FLOAT FOR AIR BREAK BOWL</i>
	37		<b>9111.622</b>	TANK AIR BREAK <i>SERBATOIO AIR BREAK</i>
	38		<b>U110.005</b>	SCREW AUT.TCB 3,9X9,5 DIN 7981F <i>VITE AUT.TCB 3,9X9,5 DIN 798</i>
	39		<b>0875.207</b>	PIN FOR BOSS D.8 <i>PIN FOR BOSS D.8</i>
	40		<b>U046.003</b>	SCREW TCBD TORX 20 M4X12 ZN-B <i>VITE TCBC M4,0X12 ROND.DENT.</i>

## Model Machine

MACSAE111

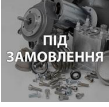





SAECO RUBINO 200 чорна (верхня частина)(10003260 )

	41		<b>9121.214.00A</b>	SAFETY ELECTROVALVE 230V <i>ELETTROVALVOLA DI SICUREZZA 230V</i>
	41		<b>9121.214.00F</b>	SAFETY ELECTROVALVE 120V 60HZUL <i>SAFETY ELECTROVALVE 120V 60HZ UL</i>
	41		<b>9121.214.00R</b>	SAFETY ELECTROVALVE 100V 50/60HZ <i>SAFETY ELECTROVALVE 100V 50/60HZ</i>
	42		<b>NV03.002</b>	CAP 3/4 "KAPSTO 800R 3/4" <i>"CAP 3/4 "KAPSTO 800R 3/4""</i>
	43		<b>11010600</b>	TUBE SUPPORT <i>TUBE SUPPORT</i>
	43		<b>1813.011</b>	SOLENOID VALVE SUPPORT <i>SOLENOID VALVE SUPPORT</i>
	44		<b>U143.025</b>	SCREW TCB PH.3.5X16 SP UT 014 <i>SCREW TCB PH.3.5X16 SP UT 014</i>
	45		<b>11010331</b>	CLOSED PLATE <i>CLOSED PLATE</i>
	46		<b>1813.631</b>	HARNESS <i>HARNESS</i>
	46		<b>1813.647</b>	HARNESS <i>HARNESS</i>
	47		<b>1813.049</b>	MICRO SUPPORT <i>MICRO SUPPORT</i>
	48		<b>NE05.039</b>	BIPOLAR MICROSWITCH <i>MICROINTERRUTTORE BIPOLARE</i>
	48		<b>NE05.061</b>	MICROSWITCH CHERRY D413 .V3LD <i>MICROINT.BIPOLARE XTD 22AZ1</i>
	49		<b>1813.A17.00F</b>	MICRO ASS. 120V UL <i>MICRO ASS. 120V UL</i>

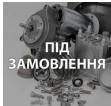
## Model Machine

MACSAE111

















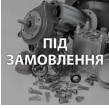





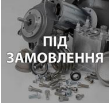

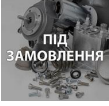
SAECO RUBINO 200 чорна (верхня частина)(10003260 )

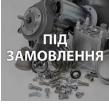
	49		<b>1813.A17.00P</b>	MICRO ASS. <i>MICRO ASS.</i>
	50		<b>NF13.007</b>	RING FOR PIN D.5 QUICLOCK 5-20 <i>RING FOR PIN D.5 QUICLOCK 5-20</i>
	51		<b>U208.006</b>	TOOTHED WASHER 6,4X11 UNI 3703 <i>ROSETTA DENT. 6,4X11 UNI 3</i>
	52		<b>U302.004</b>	NUT HEXAGONAL M6 UNI 5588 <i>DADO ESAGONALE M6 UNI 5</i>
	53		<b>129720102</b>	TE SCREW M4X20 UNI 5739 ZNP <i>TE SCREW M4X20 UNI 5739 ZNP</i>
	54		<b>1813.218</b>	BRACKET <i>BRACKET</i>
	55		<b>U109.003</b>	SCREW TCB 3,5X9,5 DIN 7981 C NICK <i>SCREW TCB 3,5X9,5 DIN 7981 C NICK</i>
	56		<b>1813.165.050</b>	SPACER <i>DISTANZIALE PER MOLLA POMPA</i>
	57		<b>1813.170</b>	FLOWMETER SUPPORT <i>FLOWMETER SUPPORT</i>
	58		<b>1813.194.A20</b>	HOPPER <i>HOPPER</i>
	59		<b>U109.016</b>	SCREW AUT.TCB 3,9X13 DIN 7981C <i>SCREW AUT.TCB 3,9X13 DIN 7981 C</i>
	60		<b>11001838</b>	VAIN TANK UNLOADING UL <i>VAIN TANK UNLOADING UL</i>
	60		<b>11002735</b>	VAIN TANK UNLOADING BEIGE <i>VANO VASCHETTA SCARICHI BEIGE</i>
	60		<b>11003332</b>	VAIN TANK UNLOADING BEI UL <i>VAIN TANK UNLOADING BEI UL</i>

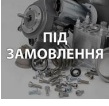
## Model Machine

MACSAE111

SAECO RUBINO 200 чорна (верхня частина)(10003260 )









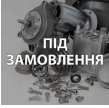

	60		<b>11021468</b>	VAIN TANK UNLOADING BLACK <i>VAIN TANK UNLOADING BLACK</i>
	60		<b>11021485</b>	VAIN TANK UNLOADING BLACK UL <i>VAIN TANK UNLOADING BLACK UL</i>
	60		<b>1813.012.850</b>	VAIN TANK UNLOADING <i>VAIN TANK UNLOADING</i>
	61		<b>11001844</b>	WATER TANK ASSEMBLY UL <i>WATER TANK ASSEMBLY UL</i>
	61		<b>11002688</b>	WATER TANK ASSEMBLY BEIGE <i>ASS.VASCHETTA SCARICO ACQUA BEIGE</i>
	61		<b>11003420</b>	ASS.VAIN TANK UNLOADING UL <i>ASS.VAIN TANK UNLOADING UL</i>
	61		<b>11021462</b>	WATER TANK ASSEMBLY BLACK <i>WATER TANK ASSEMBLY BLACK</i>
	61		<b>11021487</b>	ASS.VAIN TANK UNLOADING BLACKUL <i>ASS.VAIN TANK UNLOADING BLACKUL</i>
	61		<b>1813.A06.850</b>	WATER TANK ASS. <i>WATER TANK ASS.</i>
	62		<b>11001839</b>	TANK UNLOADING UL <i>TANK UNLOADING UL</i>
	62		<b>11002736</b>	VAIN TANK UNLOADING BEIGE <i>VASCHETTA SCARICHI ESTRAIBILE BEIGE</i>
	62		<b>11003333</b>	TANK UNLOADING BEI UL <i>TANK UNLOADING BEI UL</i>
	62		<b>11021469</b>	VAIN TANK UNLOADING BLACK <i>VAIN TANK UNLOADING BLACK</i>

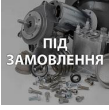

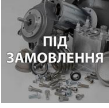
## Model Machine

MACSAE111

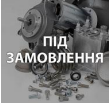
SAECO RUBINO 200 чорна (верхня частина)(10003260 )

	62		11021486	TANK UNLOADING BLACK UL <i>TANK UNLOADING BLACK UL</i>
	62		1813.013.850	TANK UNLOADING <i>VASCHETTA SCARICHI ESTRAIBILE</i>
	63		1813.017	COIN CASE <i>COIN CASE</i>
	64		NV01.015	FOOT D.22 H.18 M6 <i>PIEDINO D.22 H.18 M6</i>
	65		1813.095	TANK <i>TANK</i>
	66		1813.016.A20	TABLET VAIN <i>TABLET VAIN</i>

# Model Machine

MACSAE111

SAECO RUBINO 200 чорна (верхня частина)(10003260 )

MACSAE111.T.0002

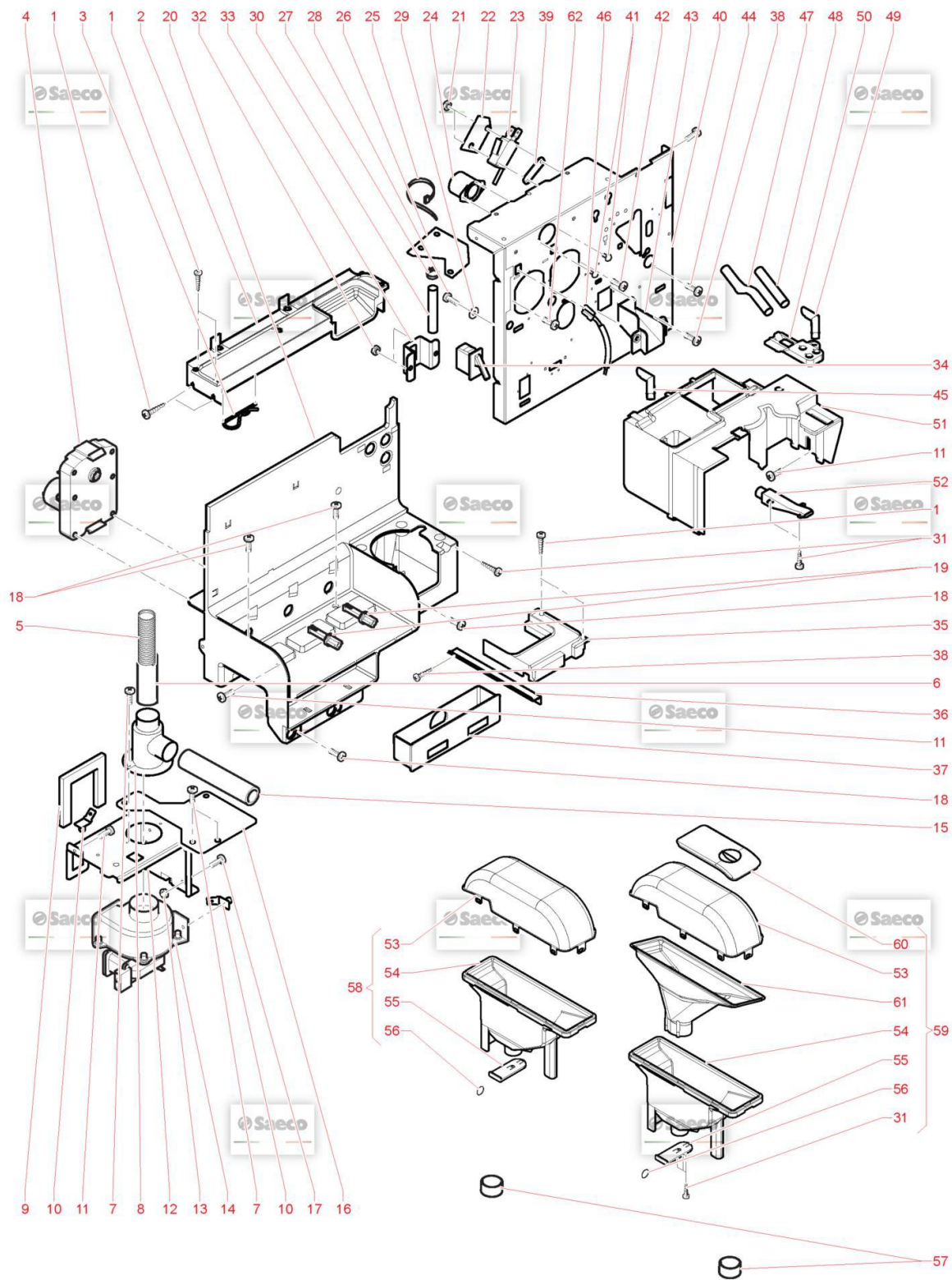

## Model Machine

MACSAE111

SAECO RUBINO 200 чорна (верхня частина)(10003260 )

Web Pos. Foto Item - Replace by Description



Press - CTRL + CLICK go to item in a new window

Натисніть - Ctrl + права кнопка миші щоб відкрити запчастину в новому вікні



1



U109.016

SCREW AUT.TCB 3,9X13 DIN 7981C  
SCREW AUT.TCB 3,9X13 DIN 7981 C



2

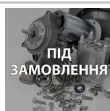

1813.031.A20

REAR CROSS BEAM  
REAR CROSS BEAM



2

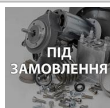

1813.305.050

REAR CROSS BEAM UL  
REAR CROSS BEAM UL



3

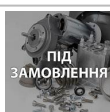

U462.003

SPLIT PIN 2.25X42 UNI 8833  
SPLIT PIN 2.25X42 UNI 8833



4

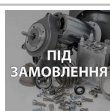

9121.216.00P

RATIOMOTOR 90 RPM 24V  
MOTORIDUTTORE KENTA 90 RPM 2



5



9111.638

SPRING FOR TUBE  
SPRING FOR TUBE



6

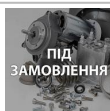

11000239

TUBE  
TUBE



7



U110.005

SCREW AUT.TCB 3,9X9,5 DIN 7981F  
VITE AUT.TCB 3,9X9,5 DIN 798



8

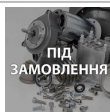

11000043

BUSH  
BUSH



9

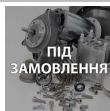

9111.644

SEAL  
SEAL



10

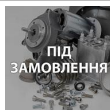

NE13.022

COPPER RIVET D.4 WITH TONGUE 6,3  
COPPER RIVET D.4 WITH TONGUE 6,3



11

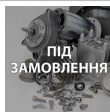

U046.007

SCREW TEFZ M4,0X12 GALV.  
SCREW TEFZ M4,0X12 GALV.



12













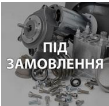













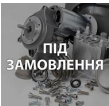

1813.010

FAN SUPPORT  
FAN SUPPORT

## Model Machine

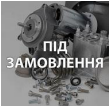
MACSAE111























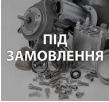

SAECO RUBINO 200 чорна (верхня частина)(10003260 )

	12		<b>1813.309</b>	FAN SUPPORT <i>FAN SUPPORT</i>
	13		<b>U324.006</b>	NUT M4 FLANGED INDENTED BASE <i>NUT M4 FLANGED INDENTED BASE</i>
	14		<b>9121.009.00A</b>	MOTOR WITH FAN 230V <i>MOTORE CON VENTOLA 230V</i>
	14		<b>9121.009.00F</b>	MOTOR WITH FAN 120V <i>MOTOR WITH FAN 120V</i>
	14		<b>9121.009.00N</b>	MOTOR WITH FAN 220V 60HZ <i>MOTOR WITH FAN 220V 60HZ</i>
	14		<b>9121.009.00R</b>	MOTOR WITH FAN 100V 50/60HZ <i>MOTOR WITH FAN 100V 50/60HZ</i>
	15		<b>11000240</b>	TUBE <i>TUBE</i>
	16		<b>1813.223</b>	SOLENOID VALVE SUPPORT PLATE <i>SOLENOID VALVE SUPPORT PLATE</i>
	17		<b>U043.011</b>	SCREW TCBC M4,0X12 UNI 7687 GALV. <i>SCREW TCBC M4,0X12 UNI 7687 GALV.</i>
	18		<b>U044.013</b>	SCREW TSPC M4,0X12 UNI 7688 GALV. <i>VITE TSPC M4,0X12 UNI 7688 ZNP</i>
	19		<b>9111.586.050</b>	PIN FOR MOTORS KENTA <i>PERNO X MOTORI KENTA</i>
	20		<b>1813.047.A20</b>	RATIOMOTOR +BOXSUPPORT <i>SUPPORTO MOTORID. E SCATOLA</i>
	21		<b>U324.005</b>	NUT M3 FLANGED INDENTED BASE <i>DADO M3 FLANGIATO BASE DENTELLATA</i>
	22		<b>9991.014</b>	CARD FOR MICRO SWITCHES <i>CARTONCINO X MICROINTERRUPTORE</i>

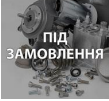
## Model Machine

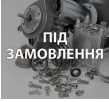
MACSAE111











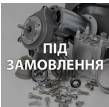

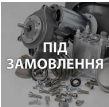

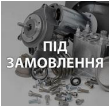











SAECO RUBINO 200 чорна (верхня частина)(10003260 )

	23		<b>NE05.060</b>	MICROSWITCH CHERRY D413-VGAQ <i>MICROINTERRUTTORE CHERRY D41</i>
	24		<b>0870.048</b>	ASPIRATION BUSH <i>ASPIRATION BUSH</i>
	25		<b>NF11.002</b>	SELF LOCK STRIP W=2.5 L=98 <i>SELF LOCK STRIP W=2.5 L=98</i>
	26		<b>9111.473</b>	INSULATOR FOR BOILER SUPPORT <i>ISOLANTE X SUPPORTO CALDAIA</i>
	27		<b>NV99.036</b>	HOSECLAMP D=8,5 09993.41.00 <i>HOSECLAMP D=8,5 09993.41.00</i>
	28		<b>U127.005</b>	SCREW TAPT.TCB M4,0X8 DIN 7500C <i>SCREW TAPT.TCB M4,0X8 DIN 7500C</i>
	29		<b>128310404</b>	МЕТАЛЕВЕ УБЧАСТЕ КОЛІЩАТКО UNI 8842 A4 <i>WASHER UNI 8842 A4 BURNISHED</i>
	30		<b>9972.186</b>	SILICONE TUBE 5X10 L.375MM <i>SILICONE TUBE 6X9 L.375 MM</i>
	31		<b>U116.006</b>	SCREW AUT.PT TCB 3,5X12 WN 1441 ZNP <i>VITE AUT.PT TCB 3,5X12 WN 1441 ZNP</i>
	32		<b>U324.003</b>	NUT M5 FLANGED INDENTED BASE <i>NUT M5 FLANGED INDENTED BASE</i>
	33		<b>1813.060</b>	SUPPORT FOR MICRO <i>SUPPORT FOR MICRO</i>
	34		<b>NE05.063</b>	MICROSWITCH + LEVER <i>MICROINTERRUTTORE C/LEVA</i>
	35		<b>1813.021.A20</b>	SUPPORT TANK COFFEE <i>SUPPORTO CAMPANA CAFFE' ANTE</i>

## Model Machine

MACSAE111















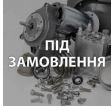

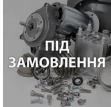

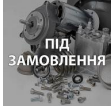

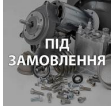

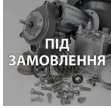

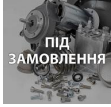

SAECO RUBINO 200 чорна (верхня частина)(10003260 )

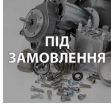
	36		1813.094	SUPPORT <i>SUPPORT</i>
	37		1813.024.A20	VAIN BOX ASPIRATION <i>VAIN BOX ASPIRATION</i>
	38		U109.011	SCREW AUT.TCB 3,9X9,5 DIN 7981C <i>SCREW AUT.TCB 3,9X9,5 DIN 7981 C</i>
	39		9111.407	MICRO PLATE <i>MICRO PLATE</i>
	40		1813.310	ASS.SUPPORT <i>ASS.SUPPORT</i>
	41		NF11.015	EXPANSION RIVET D=2,8X8 ALU. <i>RIVETTO AD ESPANS. D=2,9X9 A</i>
	42		NF11.115	BLIND RIVETS <i>BLIND RIVETS</i>
	43		1813.077.050	UNLOADED VENT <i>UNLOADED VENT</i>
	44		U046.003	SCREW TCBD TORX 20 M4X12 ZN-B <i>VITE TCBC M4,0X12 ROND.DENT.</i>
	45		9111.349	ELBOW DISPENSING NOZZLE <i>UGELLO EROGAZIONE GOMITO</i>
	46		11000521	FUSE MIXER WIRED UL <i>FUSE MIXER WIRED UL</i>
	46		11006374	FUSE MIXER WIRED <i>FUSIBILE MIXER CABLATO</i>
	47		9972.209	SILICONE TUBE 5X8 L.240 <i>SILICONE TUBE BROWN 5X8 L.240</i>
	48		9972.093	SILICONE TUBE 5X8 L.160MM <i>SILICONE TUBE BROWN 5X8 L.160 MM</i>

## Model Machine

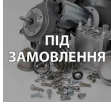
MACSAE111

SAECO RUBINO 200 чорна (верхня частина)(10003260 )

	49		1813.109.050	NOZZLES NOZZLES
	50		1813.029.050	NOZZLES PLATE NOZZLES PLATE
	51		1813.018.A20	DRIPTRAY SURFACE DRIPTRAY SURFACE
	51		1813.304.050	DRIPTRAY SURFACE UL DRIPTRAY SURFACE UL
	52		11000042	CONVEYOR CONVEYOR
	53		1813.026	UPPER TANK COFFEE UPPER TANK COFFEE
	54		1813.025.A20	LOWER TANK COFFEE CAMPANA CAFFE' INFERIORE
	55		1813.027.A20	SHUTTER FOR COFFEE CONTAINER SHUTTER FOR COFFEE CONTAINER
	56		1431.003	KEYHOLDER RING KEYHOLDER RING
	57		11010641	SEAL SEAL
	58		1813.A08	ASS.TANK COFFEE ASSIEME CAMPANA CAFFE'
	59		11012162	ASS.TANK COFFEE ASS.TANK COFFEE
	60		11011325	COFFEE CONTAINER COVER RUBINO200 COFFEE CONTAINER COVER RUBINO200
	61		11011326	ADAPTER COFFEE CONTAINER COVER RUBINO200 ADAPTER COFFEE CONTAINER COVER RUBINO200

## Model Machine

MACSAE111

SAECO RUBINO 200 чорна (верхня частина)(10003260 )



62



U109.003

SCREW TCB 3,5X9,5 DIN 7981 C NICK

SCREW TCB 3,5X9,5 DIN 7981 C NICK



# Model Machine

MACSAE111

SAECO RUBINO 200 чорна (верхня частина)(10003260 )

MACSAE111.T.0003

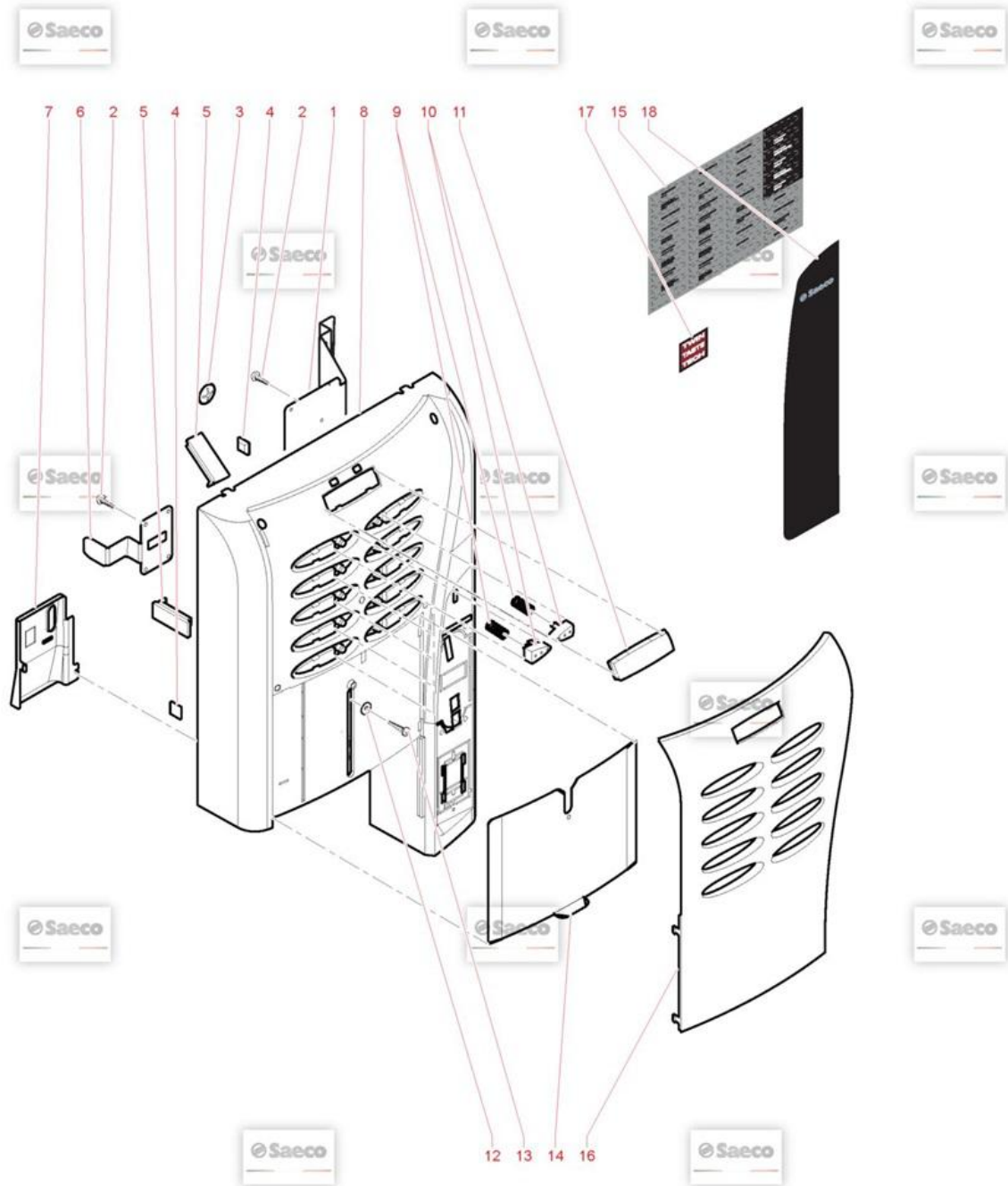

## Model Machine

MACSAE111

SAECO RUBINO 200 чорна (верхня частина)(10003260 )

Web Pos. Foto Item - Replace by Description



Press - CTRL + CLICK go to item in a new window



























Натисніть - Ctrl + права кнопка миші щоб відкрити запчастину в новому вікні

	1		<b>1813.125</b>	REINFORCE STIRRUP DOOR <i>REINFORCE STIRRUP DOOR</i>
	2		<b>U116.006</b>	SCREW AUT.PT TCB 3,5X12 WN 1441 ZNP <i>VITE AUT.PT TCB 3,5X12 WN 1441 ZNP</i>
	3		<b>NF13.006</b>	RING FOR PIN D.3 QUICLOCK ZINC <i>RING FOR PIN D.3 QUICLOCK ZINC</i>
	4		<b>NV01.007</b>	РЕЗИНОВА НАКЛЕЙКА 1 ШТ <i>PIEDINO ADESIVO</i>
	5		<b>NE17.001</b>	ADH.CABLE RETAIN.FLAT CABLE L=30MM <i>ADH.CABLE RETAIN.FLAT CABLE L=30MM</i>
	6		<b>1813.086</b>	PLATE <i>PLATE</i>
	7		<b>11002877</b>	CARD COVER BEIGE <i>CARD COVER BEIGE</i>
	7		<b>1813.102.850</b>	CARD COVER <i>CARD COVER</i>
	8		<b>11002740</b>	DOOR SG 200 BEIGE <i>PORTA SG 200 BEIGE</i>
	8		<b>11002741</b>	DOOR SG 200 UL BEIGE <i>DOOR SG 200 UL BEIGE</i>
	8		<b>11021470</b>	DOOR SG 200 BLACK <i>DOOR SG 200 BLACK</i>
	8		<b>11021471</b>	DOOR SG 200 UL BLACK <i>DOOR SG 200 UL BLACK</i>
	8		<b>11023211</b>	PORTA UL BLK <i>PORTA UL BLK</i>

## Model Machine

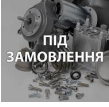
MACSAE111

















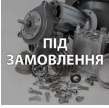

SAECO RUBINO 200 чорна (верхня частина)(10003260 )

	8		1813.080.850	DOOR <i>PORTA</i>
	9		1813.114	SPRING FOR BUTTON <i>MOLLA X PULSANTE</i>
	10		11002743	КНОПКА SAECO RUBINO <i>PUSH BUTTON RED</i>
	10		11021459	PUSH BUTTON BLACK <i>PUSH BUTTON BLACK</i>
	10		1813.083.930	PUSH BUTTON <i>PUSH BUTTON</i>
	11		1813.084	DISPLAY GLASS <i>DISPLAY GLASS</i>
	12		U207.004	PLAIN WASHER 4,3X16 UNI 6592 GAL <i>PLAIN WASHER 4,3X16 UNI 6592 GAL</i>
	13		129823802	TCB SCREW M4X8 UNI 7687 ZNP <i>VITE TCB M4X8 UNI 7687 ZNP</i>
	14		1813.059.230	TRANSPARENT DOOR <i>SPORTELLLO TRASPARENTE</i>
	15		15001954	LABEL SHEET PROD.RUBINO200 BLKITA <i>LABEL SHEET PROD.RUBINO200 BLK ITA</i>
	15		15001955	LABEL SHEET PROD.RUBINO200 BLKENG <i>LABEL SHEET PROD.RUBINO200 BLK ENG</i>
	15		15001956	LABEL SHEET PROD.RUBINO200 BLKDE <i>LABEL SHEET PROD.RUBINO200 BLK DE</i>
	15		15001957	LABEL SHEET PROD.RUBINO200 BLKFRA <i>LABEL SHEET PROD.RUBINO200 BLKFRA</i>
	15		15001958	LABEL SHEET PROD.RUBINO200 BLKESP <i>LABEL SHEET PROD.RUBINO200 BLKESP</i>

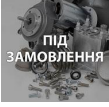
## Model Machine

MACSAE111

SAECO RUBINO 200 чорна (верхня частина)(10003260 )

	15		15001959	LABEL SHEET PROD.RUBINO200 BLKPOR <i>LABEL SHEET PROD.RUBINO200 BLK POR</i>
	15		15001970	LABEL SHEET PROD.RUBINO200 BLKNL <i>LABEL SHEET PROD.RUBINO200 BLKNL</i>
	15		15001971	LABEL SHEET PROD.RUBINO200 BLKCH <i>LABEL SHEET PROD.RUBINO200 BLKCH</i>
	15		15002070	LABEL SHEET PROD.RUBINO200TTTGREY <i>LABEL SHEET PROD.RUBINO200TTTGREY</i>
	16		11002742	FRONT COVER DOOR RED <i>FRONT COVER DOOR RED</i>
	16		11024209	FRONT COVER DOOR SILVER <i>FRONT COVER DOOR SILVER</i>
	17		15002044	LABEL TWIN TASTE TECH GREY <i>LABEL TWIN TASTE TECH GREY</i>
	18		11002738	PLATE PAYMENT SYSTEMS BEIGE <i>TARGA ADESIVA SISTEMI DI PAGAMENTO BEIGE</i>
	18		11021367	PLATE ADHESIVE SYSTEM PAYMENTBLACK <i>PLATE ADHESIVE SYSTEM PAYMENT BLACK</i>
	18		1813.057.850	PLATE 6P <i>TARGA ADESIVA SISTEMI DI PAGAMENTO</i>

# Model Machine

MACSAE111

SAECO RUBINO 200 чорна (верхня частина)(10003260 )



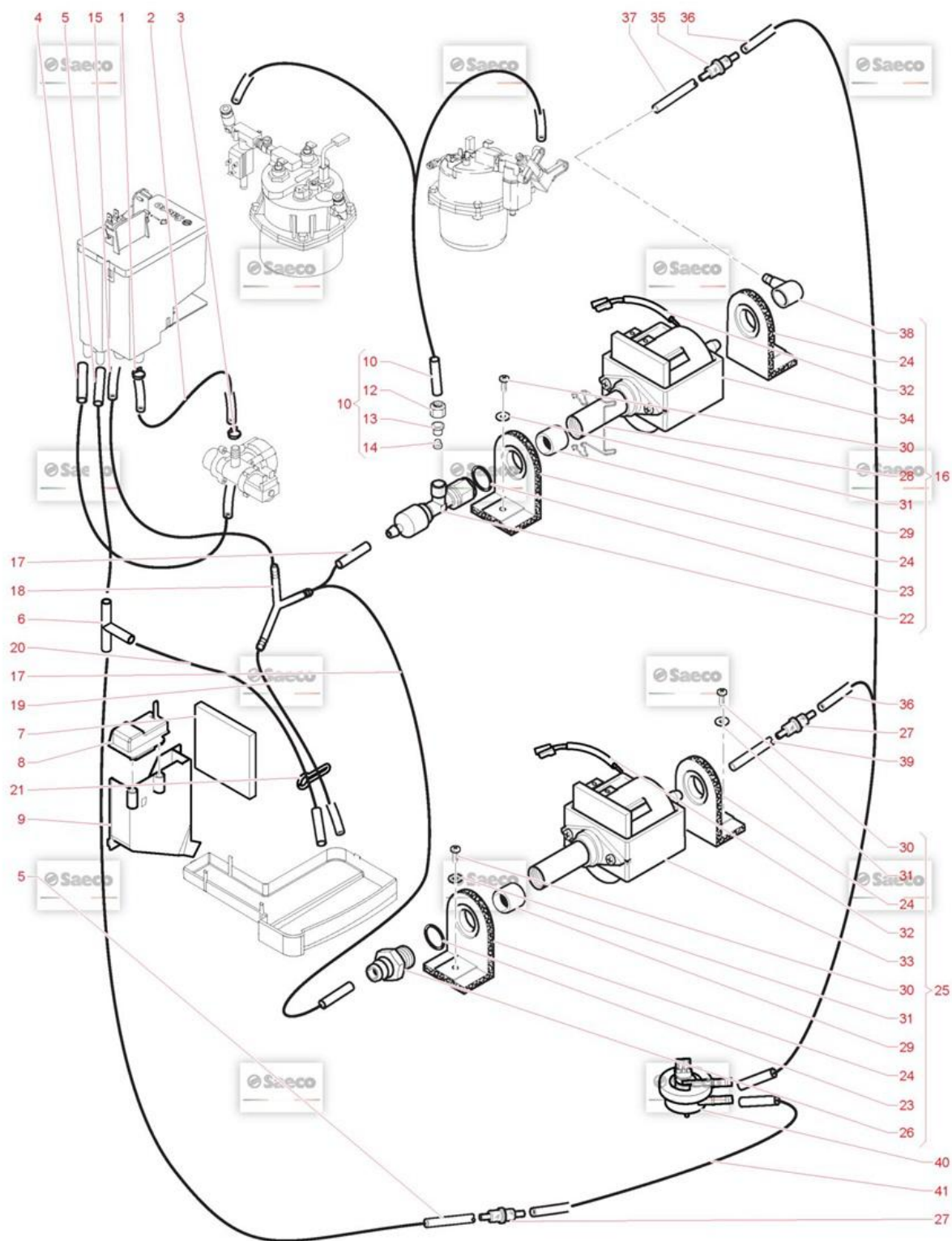











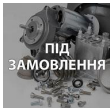



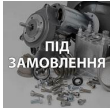

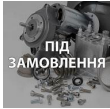

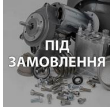

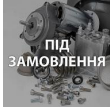

MACSAE111.T.0004

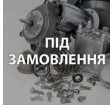

## Model Machine

MACSAE111











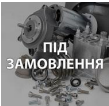













SAECO RUBINO 200 чорна (верхня частина)(10003260 )

Web	Pos.	Foto	Item - Replace by	Description
				<i>Press - CTRL + CLICK go to item in a new window Натисніть - Ctrl + права кнопка миші щоб відкрити запчастину в новому вікні</i>
	1		NV99.072	HOSE CLAMP D. 11.6/12.3 HOSE CLAMP D. 11.6/12.3
	2		9972.085	SILICONE TUBE 5X10 L.400MM SILICONE TUBE 5X10 L.400MM
	3		184320200	SPRING HOSE CLAMP D=9,5MM MOLLA STRINGITUBO D=9,5MM
	4		9972.290	***SILICONE TUBE 7X11 L.420MM ***SILICONE TUBE 7X11 L.420MM
	5		9972.322	SILICONE TUBE 7X11 L.2000MM SILICONE TUBE 7X11 L.2000MM
	6		NV99.068	PLASTIC "T "CONNECTOR 3 WAY "PLASTIC "T "CONNECTOR 3 WAY "
	7		11013443	INSULATE PROTECTION INSULATE PROTECTION
	8		9161.262.060	DRIP CHANNEL COVER COPERTURA CANALINO RACCOGLIGOCCE
	9		1813.030.050	COFFEE DISCHARGE CHANNEL 6P COFFEE DISCHARGE CHANNEL 6P
	10		11004110	TEFLON TUBE ASS. 4X6 L.275 1/8" UL TEFLON TUBE ASS. 4X6 L.275 1/8" UL
	10		9979.A03	TEFLON TUBE ASS. 4X6 L.275 1/8"-1/8 ASS.TUBO TEFLON 4X6 L.275 1/8-1/8
	10		9979.A22	TEFLON TUBE ASS. 4X6 L.275 1/8" ASS.TUBO TEFLON 4X6 L.275 1/8
	10		9979.B54	TEFLON TUBE ASS. 4X6 L.275 1/8"-1/8 TEFLON TUBE ASS. 4X6 L.275 1/8"-1/8

## Model Machine

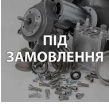
MACSAE111

















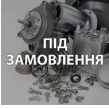





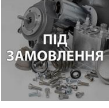

SAECO RUBINO 200 чорна (верхня частина)(10003260 )

	11		<b>9971.004</b>	TUBE TEFLON 4X6 L.275MM <i>TUBO TEFLON 4X6 L.275 MM</i>
	12		<b>9991.007</b>	NUT FOR CONNECTOR 1/8" <i>NUT FOR CONNECTOR 1/8 NUOVO PREZZO 0,89</i>
	13		<b>9991.009</b>	INSIDE BUSH D.4 <i>INSIDE BUSH D.4</i>
	13		<b>9991.129</b>	INTERNAL BUSH D.4 BRASS NIK <i>BOCCOLA INTERNA D.4 OTTONE N</i>
	14		<b>9991.008</b>	ЗОВНІШНЯ ОБЖИМКА Д,6 SAECO 121800420 BIANCHI 19046526 <i>EXTERNAL BUSH D.6</i>
	15		<b>9972.232</b>	SILICONE TUBE 5X8 L.180MM <i>SILICONE TUBE BROWN 5X8 L.180 MM</i>
	15		<b>9972.255</b>	***SILICONE TUBE 7X11 L.400MM <i>SILICONE TUBE 7X11 L.400 MM</i>
	16		<b>11001466</b>	PUMP ASSEMBLY 220V 60HZ SG 200 <i>PUMP ASSEMBLY 220V 60HZ SG 200</i>
	16		<b>11007329</b>	ASSEMBLY PUMP EP7 F.B. 230V <i>ASSEMBLY PUMP EP7 F.B. 230V</i>
	16		<b>11007340</b>	ASSEMBLY PUMP EP7 F.B. 120V UL <i>ASSEMBLY PUMP EP7 F.B. 120V UL</i>
	16		<b>11013445</b>	HS1 PUMP WITH SAFETY VALVE 230V <i>HS1 PUMP WITH SAFETY VALVE 230V</i>
	16		<b>11021897</b>	HS1 PUMP WITH SAFETY VALVE 220V <i>HS1 PUMP WITH SAFETY VALVE 220V</i>
	16		<b>11022066</b>	PUMP HS1 120V UL <i>PUMP HS1 120V UL</i>
	16		<b>1883.A04.00A</b>	PUMP ASS. 230V <i>PUMP ASS. 230V</i>

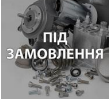
## Model Machine

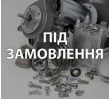
MACSAE111

SAECO RUBINO 200 чорна (верхня частина)(10003260 )











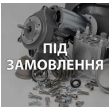

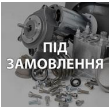













	16		<b>1883.A04.00F</b>	PUMP ASS. 120V UL <i>PUMP ASS. 120V UL</i>
	16		<b>1884.A04.00R</b>	PUMP ASS. 100V UL <i>PUMP ASS. 100V UL</i>
	17		<b>9972.186</b>	SILICONE TUBE 5X10 L.375MM <i>SILICONE TUBE 6X9 L.375 MM</i>
	17		<b>9972.201</b>	***SILICONE TUBE 5X10 L.140MM <i>***SILICONE TUBE 5X10 L.140MM</i>
	17		<b>9972.210</b>	SILICONE TUBE 5X8 L.190MM <i>SILICONE TUBE BROWN 5X8 L.190 MM</i>
	18		<b>11013444</b>	Y COUPLING WITH TUBE <i>Y COUPLING WITH TUBE</i>
	18		<b>147920800</b>	Y CONNECTOR D=8 ART.80.26.048KA.466 <i>RACCORDO Y D=8 ART.80.26.048 KA.466</i>
	18		<b>NV99.066</b>	PLASTIC "Y" CONNECTOR 3 WAY <i>RACCORDO IN PLASTICA A "Y" 3</i>
	19		<b>11022849</b>	SILICONE TUBE 5X8 L.40MM <i>SILICONE TUBE 5X8 L.40MM</i>
	19		<b>9972.197</b>	***SILICONE TUBE 5X10 L.200MM <i>SILICONE TUBE 6X9 L.200 MM</i>
	20		<b>9972.330</b>	SILICONE TUBE 5X10 L.600MM <i>SILICONE TUBE 5X10 L.600MM</i>
	21		<b>9111.141</b>	DISCHARGE TUBE CLOSURE SPRING <i>DISCHARGE TUBE CLOSURE SPRING</i>
	22		<b>11005590</b>	SAFETY VALVE/NON RETURN ASS. NEW <i>ASS.VALVOLA SICUREZZA/NON RI</i>



## Model Machine

MACSAE111

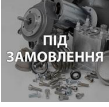









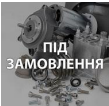





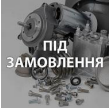







SAECO RUBINO 200 чорна (верхня частина)(10003260 )

	22		<b>9079.A28</b>	SAFETY VALVE/NON RETURN ASS. SAFETY VALVE/NON RETURN ASS.
	22		<b>9079.A39</b>	SAFETY VALVE/NON RETURN ASS. SAFETY VALVE/NON RETURN ASS.
	23		<b>140321961</b>	O-RING 2031 NFDA NBR 70 FDA OR 2031 IN TERMOIL
	24		<b>149185850</b>	ТРИМАЧ (ГУМОВИЙ)ПОМПИ ДЛЯ КАВОМАШИН SAECO MAGIC 4002012 (... SUPPORTO POMPA EATON MAGIC 4
	25		<b>2029.A01.00A</b>	PUMP ASS. 230V PUMP ASS. 230V
	26		<b>9071.100</b>	CONNECTOR FOR TUBE 8X 12 CONNECTOR FOR TUBE 8X 12
	27		<b>144650300</b>	ФІЛЬТР ОЧИСТКИ ВОДИ ДЛЯ КАВОМАШИНИ SAECO NEW (NV99.001) (88... ASPIRATION FILTER GAUZE NET 500 (NEW)
	28		<b>9111.343</b>	SPRING FOR MOTOR PUMP FIXING MOLLA X BLOCCAGGIO ELETTROPO
	29		<b>9071.098</b>	REINFORCEMENT FOR ULKA PUMP REINFORCEMENT FOR ULKA PUMP
	30		<b>U043.004</b>	ZN-B TCB TORX 20 M4X16 ZN-B VITE TCBC M4,0X16 UNI 7687 ZNP
	31		<b>U207.004</b>	PLAIN WASHER 4,3X16 UNI 6592 GAL PLAIN WASHER 4,3X16 UNI 6592 GAL
	32		<b>0862.668</b>	THERMAL PROTECTOR 100□ +FASTON THERMAL PROTECTOR 100□ +FASTON
	32		<b>0875.752</b>	THERMAL PROTECTOR 100D FOR PUMP UL THERMAL PROTECTOR 100D FOR PUMP UL
	33		<b>9070.034.00A</b>	POMPE ULKA EP7 POMPA ULKA EP7 230V

## Model Machine

MACSAE111

SAECO RUBINO 200 чорна (верхня частина)(10003260 )

	34		<b>9070.034.00F</b>	ULKA PUMP EP7 120V <i>ULKA PUMP EP7 120V</i>
	34		<b>9070.042.00A</b>	ULKA НАСОС (ПОМПА) EX5GW 230/240V 50HZ SD1 БЬЯНКО 15 BAR <i>ULKA PUMP EX5 SD1</i>
	34		<b>9070.042.00N</b>	PUMP 220V <i>ULKA PUMP EX5 SD1</i>
	34		<b>9070.042.00R</b>	PUMP 100V 50/60HZ <i>ULKA PUMP EX5SD1 100V 50/60HZ</i>
	34		<b>9070.044.00F</b>	PUMP 120V-60HZ <i>ULKA PUMP EP5 D1</i>
	35		<b>11024178</b>	WATER FILTER PHEDRA <i>WATER FILTER PHEDRA</i>
	36		<b>9972.172</b>	SILICONE TUBE 5X10 L. 50MM <i>SILICONE TUBE 5X10 L. 50MM</i>
	37		<b>9972.171</b>	SILICONE TUBE 5X10 L.260MM <i>SILICONE TUBE 5X10 60SH L=260 MM</i>
	38		<b>147920150</b>	90° INLET PUMP CONNECTOR <i>RACCORDO A 90° IN SANTOPRENE</i>
	39		<b>9972.247</b>	SILICONE TUBE 5X10 L.1400MM <i>TUBO SILICON.5X10 L=2000MM 60 SHORE</i>
	40		<b>NV99.099</b>	TURBINE D=1,2 ASSY. <i>TURBINA DIGMESA FHKSC 1,2 ARNITE OC</i>
	40		<b>NV99.100</b>	FLOWMETER <i>FLUSSIMETRO</i>
	41		<b>9972.167</b>	***SILICONE TUBE 5X10 L.165MM <i>SILICONE TUBE 5X10 60SH L=165 MM</i>

# Model Machine

MACSAE111

SAECO RUBINO 200 чорна (верхня частина)(10003260 )

MACSAE111.T.0005

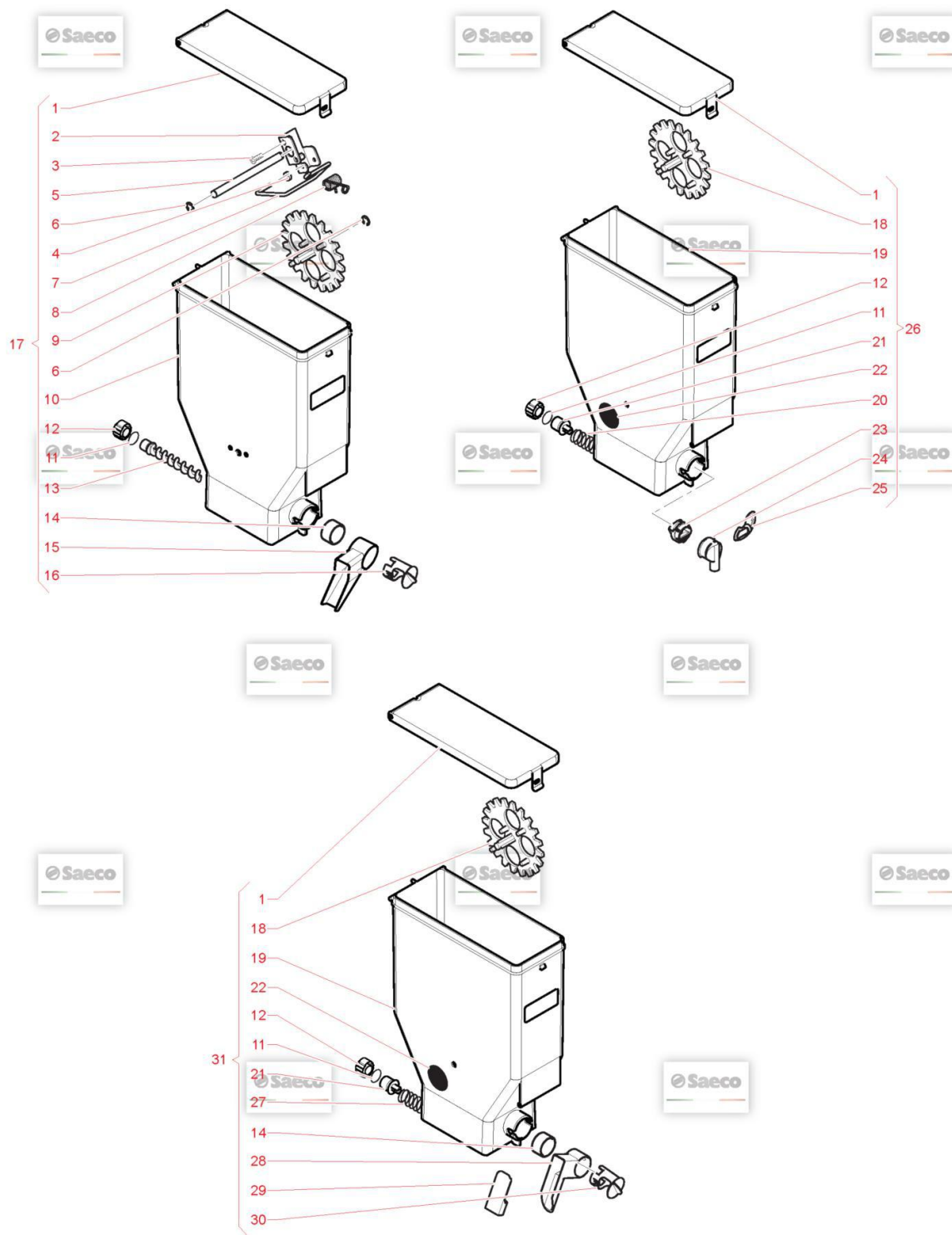

## Model Machine

MACSAE111













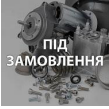











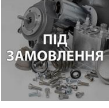

SAECO RUBINO 200 чорна (верхня частина)(10003260 )

Web	Pos.	Foto	Item - Replace by	Description
				<i>Press - CTRL + CLICK go to item in a new window Натисніть - Ctrl + права кнопка миші щоб відкрити запчастину в новому вікні</i>
	1		1813.101	SOLUBLES CONTAINER LID COPERCHIO CONTENITORE SOLUBILI
	2		9111.471	LEVER SUPPORT BRACKET SQUADRETTA SUPPORTO LEVA
	3		U046.003	SCREW TCBD TORX 20 M4X12 ZN-B VITE TCBC M4,0X12 ROND.DENT.
	4		9111.469	SPACER FOR AGITATING LEVER DISTANZIALE LEVA DI AGITAMEN
	5		9111.470	ROTATING PIN ROTATING PIN
	6		U701.001	SNAP RING 4 UNI 7434 ANELLO ELASTICO 4 UNI 7434
	7		9111.468	AGITATING LEVER LEVA DI AGITAMENTO
	8		9111.472	CONTRAST SPRING MOLLA DI CONTRASTO
	9		9111.467.060	WHEEL FOR POWDERS WITH AGITATOR RUOTA X POLVERI CON AGITATOR
	10		2062.001	CONTAINER CONTAINER
	11		NM03.013	OR 2,3X15 NBR OR 2,3X15 NBR
	12		11012130	BACK BUSH REINFORCE BACK BUSH REINFORCE
	13		9111.701	SCROLL SCREW DOUBLE CONTAINER COCLEA CONTENITORE DOPPIO

## Model Machine

MACSAE111









SAECO RUBINO 200 чорна (верхня частина)(10003260 )

	14		11001653	BUSH CONTAINER SP. 0.6 <i>BUSH CONTAINER SP. 0.6</i>
	15		11003527	SLIDE FOR CONTAINER COFFEE DUST <i>SLIDE FOR CONTAINER COFFEE DUST</i>
	16		9111.457.060	BUSH FOR LEFT/RIGHT DUCT COSMEC <i>BOCCOLA X CONDOTTO DX-SX COSMEC</i>
	17		11007286	COFFEE CONTAINER FRESH BREW <i>CONTENITORE CAFFE'PREMACINATO FRESH BREW</i>
	18		9111.014.060	WHEEL FOR POWDERS BROWN <i>RUOTA X POLVERI MARRON</i>
	19		1813.100	SOLUBLES CONTAINER SMALL <i>CONTENITORE SOLUBILI PICCOLO</i>
	20		9111.019	SPRING FOR POWDERS <i>MOLLA X POLVERI</i>
	21		9111.017.060	COUPLING FOR SPRING BROWN <i>GIUNTO X MOLLA MARRON</i>
	22		9111.646	ADHESIVE FOR TANK <i>ADHESIVE FOR TANK</i>
	23		9111.628.060	BUSH <i>BOCCOLA CON PARATIA E AGGANCI</i>
	24		9111.629.060	APERTURE FOR SOLUBLES HOPPER <i>APERTURE FOR SOLUBLES HOPPER</i>
	25		9111.338.270	BULKHEAD FOR APERT. CLOSURE ORANGE <i>PARATIA CHIUSURA BOCCHETTA ARANCIO</i>
	26		9110.099	SOLUBLES CONT. ASS. SG 200 <i>ASS.CONTENITORE SOLUBILI SG</i>
	27		9111.454	SPRING POWDERS DEVIATOR LEFT/RIGHT <i>MOLLA X POLVERI DEVIATORE DX/SX</i>

## Model Machine

MACSAE111

SAECO RUBINO 200 чорна (верхня частина)(10003260 )

	28		9111.425.060	POWDER DUCT <i>CONDOTTO POLVERE ORIENTABILE</i>
	29		9111.428.060	PLUG FOR LEFT-RIGHT DUCT <i>TAPPO X CONDOTTO DX-SX</i>
	30		9111.427.060	BUSH FOR LEFT RIGHT- DUCT <i>BOCCOLA X CONDOTTO DX-SX</i>
	31		9110.100	SOLUBLES CONT.ASS.DEV.LEFT SG200 <i>ASS.CONTENTIT.SOLUBILI DEV.SX SG 200</i>

# Model Machine

MACSAE111

SAECO RUBINO 200 чорна (верхня частина)(10003260 )

MACSAE111.T.0006

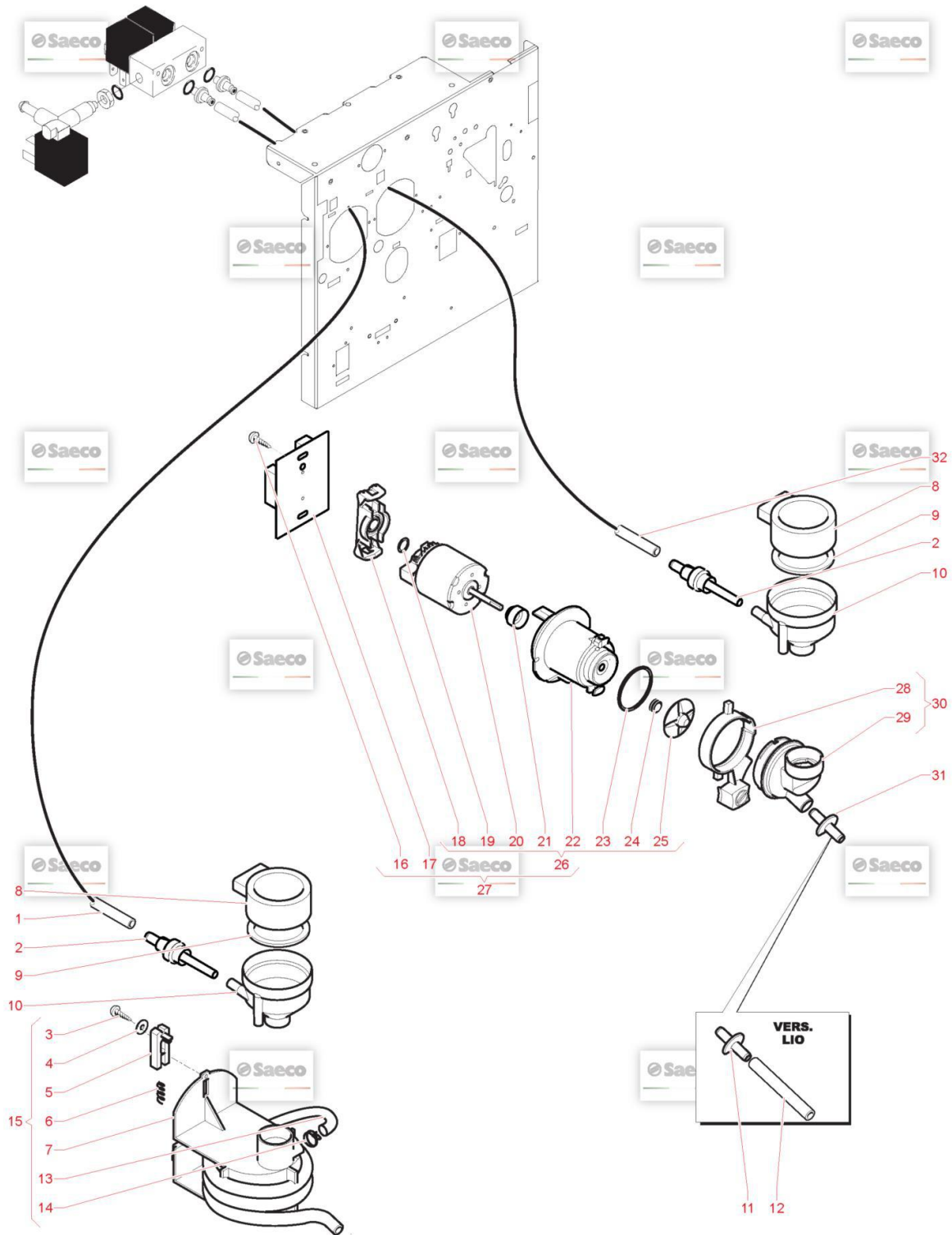

## Model Machine

MACSAE111

SAECO RUBINO 200 чорна (верхня частина)(10003260 )

Web Pos. Foto Item - Replace by Description



Press - CTRL + CLICK go to item in a new window

Натисніть - Ctrl + права кнопка миші щоб відкрити запчастину в новому вікні



1

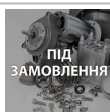

9972.121

SILICONE TUBE 3,5X6 L=260 MM  
SILICONE TUBE 3,5X6 L=260 MM



2



11000238

INJECTOR  
INIETTORE PORTA TUBO D. 2



3



U116.005

SCREW AUT.PT TCB 3,0X8 WN 1441  
VITE AUT.PT TCB 3,0X8 WN 1441 ZNP



4



U207.004

PLAIN WASHER 4,3X16 UNI 6592 GAL  
PLAIN WASHER 4,3X16 UNI 6592 GAL



5



9111.209.060

CURSOR FOR SPIRAL MIXER FIXING  
CURSOR FOR SPIRAL MIXER FIXING



6



9111.211

SPRING FOR MIXER CURSOR  
MOLLA X CURSORE MISCELATORE



7



9111.643.060

RAPID FIXING MIXER  
RAPID FIXING MIXER



8



9111.010.060

LID FOR FUNNEL BROWN  
COPERCHIO X IMBUTO MARRON



9



9111.011.060

SEAL FOR FUNNEL BROWN  
GUARNIZIONE X IMBUTO MARRON



10



9111.009.060

FUNNEL FOR POWDERS BROWN  
IMBUTO X POLVERI MARRON



11



9111.233.060

DECAFF.TUBE HOLDER SLEEVE  
MANICOTTO PORTATUBO DECAFFEINATO



12

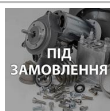

9972.232

SILICONE TUBE 5X8 L.180MM  
SILICONE TUBE BROWN 5X8 L.180 MM



13



9972.323













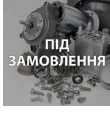





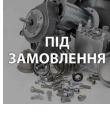





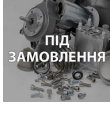

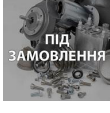
SILICONE TUBE 7X11 L.670MM  
SILICONE TUBE BROWN 7X11 L.670 MM

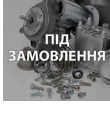

## Model Machine

MACSAE111













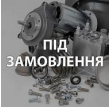

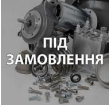

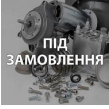

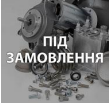

SAECO RUBINO 200 чорна (верхня частина)(10003260 )

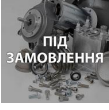
	14		NV99.072	HOSE CLAMP D. 11.6/12.3 HOSE CLAMP D. 11.6/12.3
	15	 ПІД ЗАМОВЛЕННЯ	1813.A18.060	ASS.BLENDER THE SG200 ASS.MISCELATORE TH □ SG 200
	16		129511803	SCREW TCB 2,9X6,4 DIN 7981 NICK SCREW TCB 2,9X6,4 DIN 7981 NICK
	17	 LIBERTY	9121.118.00A	CARD FOR MIXER 230V DC SCHEDINO X MIXER 230V DC
	17	 ПІД ЗАМОВЛЕННЯ	9121.118.00F	CARD FOR MIXER 120V DC CARD FOR MIXER 120V DC
	18		9111.231.270	MOTOR COUPLING ORANGE RAL AGGANCIO MOTORE ARANCIO RAL
	19		140329361	OR ORM 0100-25 TERMOIL OR METRICO 0100-25 IN TERMOIL
	20	 ПІД ЗАМОВЛЕННЯ	9121.117.00A	MIXER MOTOR 230V DC MOTORE MIXER 230V D.C.
	20	 ПІД ЗАМОВЛЕННЯ	9121.117.00F	MIXER MOTOR 120V DC MIXER MOTOR 120V DC
	20	 ПІД ЗАМОВЛЕННЯ	9121.117.00R	MIXER MOTOR 230V DC MIXER MOTOR 230V DC
	21		9111.676.060	MOTOR PROTECTION RING MOTOR PROTECTION RING
	22		9111.675.150	MIXER FLANGE FLANGIA MIXER NUOVA
	23		NM03.012	OR ORM 0320-25 NBR OR ORM 0320-25 NBR
	24		NM05.004	V-RING V6S V-RING V6S

## Model Machine

MACSAE111

SAECO RUBINO 200 чорна (верхня частина)(10003260 )

	25		9111.228.060	DISK FAN <i>VENTOLINA A DISCO</i>
	26		9110.026.06A	MIXER ASSEMBLY 230V DC <i>ASSIEME MIXER 230V DC</i>
	26		9110.026.06F	MIXER ASSEMBLY 120V DC <i>MIXER ASSEMBLY 120V DC</i>
	26		9110.026.06R	MIXER ASSEMBLY 100V DC <i>MIXER ASSEMBLY 100V DC</i>
	27		9110.131.00A	MIXER 230V ASSY. <i>ASSIEME MIXER 230V</i>
	27		9110.131.00F	ASS.MIXER 120V 60HZ <i>ASS.MIXER 120V 60HZ</i>
	27		9110.131.00R	ASS.MIXER 100V 50/60HZ <i>ASS.MIXER 100V 50/60HZ</i>
	28		9111.230.270	MIXER LOCKING RING NUT ORANGERAL <i>GHIERA BLOCCAGGIO MIXER ARANCIO RAL</i>
	29		9111.227.060	MIXER CASING <i>CORPO MIXER</i>
	30		9110.027.060	MIX CASING ASS. <i>ASS.CORPO MIX SAECO CRISTALLO,ATLANTE,QUARZO,RUBINO</i>
	31		9111.232.060	STD TUBE HOLDER SLEEVE <i>MANICOTTO PORTATUBO STANDARD</i>

# Model Machine

MACSAE111

SAECO RUBINO 200 чорна (верхня частина)(10003260 )

MACSAE111.T.0007

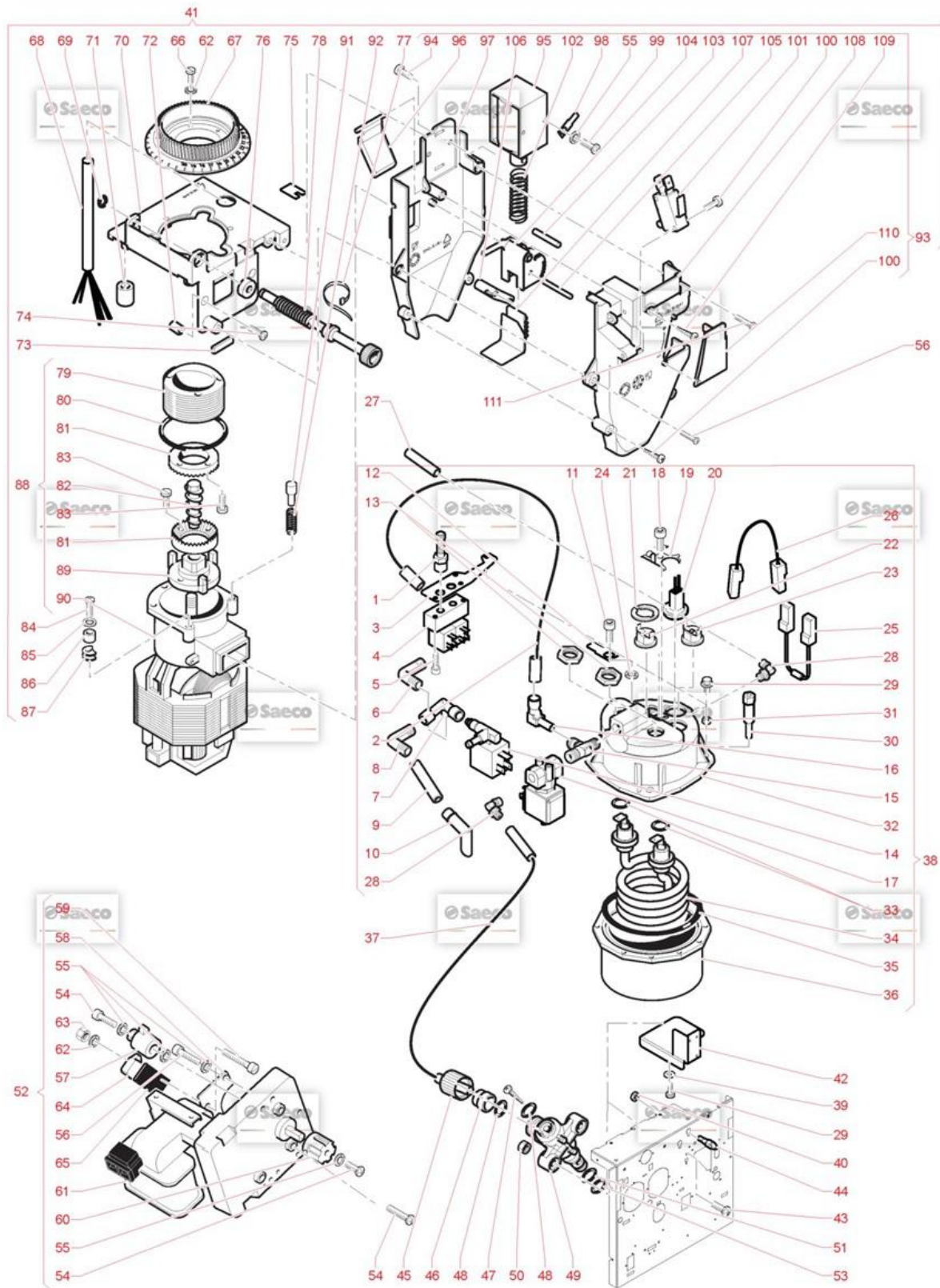

## Model Machine

MACSAE111

SAECO RUBINO 200 чорна (верхня частина)(10003260 )

Web Pos. Foto Item - Replace by Description



Press - CTRL + CLICK go to item in a new window















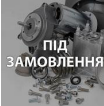

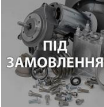

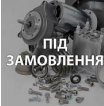



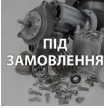

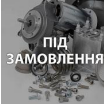

Натисніть - Ctrl + права кнопка миші щоб відкрити запчастину в новому вікні

	1		<b>NR07.047</b>	RUBBER HOLDER COUPLING 1/8 CONICAL <i>INNESTO PORTAGOMMA 1/8 CONICO</i>
	2		<b>11021818</b>	ASS.TUBE TEFLON 4X6 L.220MM 1/8"1/8" NIK <i>ASS.TUBE TEFLON 4X6 L.220MM 1/8"1/8" NIK</i>
	3		<b>11012027</b>	ELETTROVAL.SUPPORT BOILER HS1RUBINO200 <i>ELETTROVAL.SUPPORT BOILER HS1 RUBINO200</i>
	4		<b>9121.221.00A</b>	BLOCK ELECTROVALVE <i>BLOCCHETTO ELETTROVALVOLE 2</i>
	4		<b>9121.221.00F</b>	BLOCK ELECTROVALVE <i>BLOCK ELECTROVALVE</i>
	4		<b>9121.221.00N</b>	BLOCK ELECTROVALVE <i>BLOCK ELECTROVALVE</i>
	5		<b>U023.010</b>	SCREW TCEI M4,0X16 UNI 5931 BURN. <i>VITE TCEI M4,0X16 UNI 5931 BRU</i>
	6		<b>NR05.001</b>	BRASS BICONICAL CONNECTOR L M1/8X06 <i>RACCORDO BICONO A L M 1/8X06 OTT</i>
	7		<b>9181.317</b>	RACCORDO 3 VIE FEMMINA 1/8";RACCORDO 3 VIE FEMMINA 1/8" <i>RACCORDO 3 VIE FEMMINA 1/8"</i>
	8		<b>9181.337</b>	DOUBLE-CONE JOINT A L M 1/8X06NICK <i>DOUBLE-CONE JOINT A L M 1/8X06 NICK</i>
	9		<b>11022517</b>	SILICONE TUBE 5X8 L 630MM <i>SILICONE TUBE 5X8 L 630MM</i>
	10		<b>11004711</b>	NOZZLES <i>NOZZLES</i>
	11		<b>U023.020</b>	SCREW TCEI M6X20 UNI 5931 ZIN <i>VITE TCEI M6X20 UNI 5931 8.8</i>

## Model Machine

MACSAE111















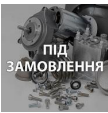





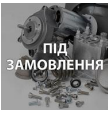

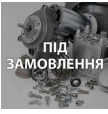

SAECO RUBINO 200 чорна (верхня частина)(10003260 )

	12		NE15.031	MALE TONGUE PLAIN 6,3 D.6,3 MALE TONGUE PLAIN 6,3 D.6,3
	13		9991.029	NUT FOR RESISTOR DADO X RESISTENZA
	14		9121.036.00A	2 WAY SOLENOID VALVE 230V ELETTROVALVOLA 2 VIE 230V
	15		9991.211	"T" CONNECTOR FOR BOILER;"T"CONNECTOR FOR BOILER RACCORDO A T X CALDAIA
	15		9991.213	CONNECTOR "T" FOR BOILER CONNECTOR "T" FOR BOILER
	16		11000242	RACCORDO SNODATO A "L" GAS M-FTEA CONNECTOR
	16		9111.403	ROTATING ELBOW CONNECTOR M1/8D.6 RACCORDO A GOMITO ORIENT. M1/8 D.6
	17		9121.138.00A	ELECTROVALVE COFFEE GROUP 230V ELETTROVALVOLA GRUPPO CAFFE'
	17		9121.138.00F	ELECTROVALVE COFFEE GROUP 120V60HZ ELECTROVALVE COFFEE GROUP 120V 60HZ
	18		12001052	SCREW TCEI M4,0X6 DIN 912 ZIN SCREW TCEI M4,0X6 DIN 912 ZIN
	19		226830200	RETAIN.SPRING 3 THERM. +THERMAL FUSE RETAIN.SPRING 3 THERM. +THERMAL FUSE
	20		11000076	ASS.SENSOR 8P UL ASS.SENSOR 8P UL
	20		11000316	ASSEMBLY HORIZONTAL SENSOR SG200 ASSEMBLY HORIZONTAL SENSOR SG200
	21		9991.085	THERMOSTAT FIXING WASHER RONDELLA FERMATERMOSTATI

## Model Machine

MACSAE111











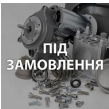

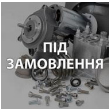







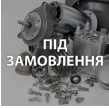

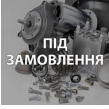

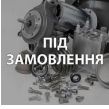

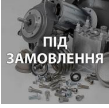
SAECO RUBINO 200 чорна (верхня частина)(10003260 )

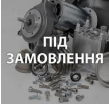
	22		NE09.021	THERMOSTAT 150°NC FASTON 90° <i>TERMOSTATO 150°NC FASTON 90°</i>
	23		189428700	THERMOSTAT 175° 1NT-15L-5126 <i>THERMOSTAT 175° 1NT-15L-5126</i>
	24		U204.001	ELAS. WASHER 6,4X11,4 UNI 1751ZIN <i>ELAS. WASHER 6,4X11,4 UNI 1751 ZIN</i>
	25		0862.699	THERMAL FUSE HARNESS UL <i>THERMAL FUSE HARNESS UL</i>
	26		1813.628	HARNESS <i>CABLAGGIO PROTEZIONE TERMICA</i>
	26		1813.643	HARNESS <i>HARNESS</i>
	27		11025293	TEFLON TUBE 3X6 L.275 1/8"-1/8 <i>TEFLON TUBE 3X6 L.275 1/8"-1/8</i>
	28		11025082	1/8"G M/CONICAL ORIENT. NUT/OGV <i>1/8G M/CONICAL ORIENT. NUT/OGV</i>
	28		NR05.030	BICONIC. CONN. L M 1/8X06 SS <i>BICONIC. CONN. L M 1/8X06 SS</i>
	29		U046.005	SCREW TE M5,0X10 WITH WASHER <i>SCREW TE M5,0X10 WITH WASHER</i>
	30		11012028	PIN FIXING BOILER HS1 RUBINO200 <i>PIN FIXING BOILER HS1 RUBINO200</i>
	31		U324.006	NUT M4 FLANGED INDENTED BASE <i>NUT M4 FLANGED INDENTED BASE</i>
	32		11002259	UPPER DOSER CASING M6 TEA <i>UPPER DOSER CASING M6 TEA</i>

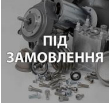
## Model Machine

MACSAE111

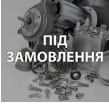









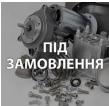

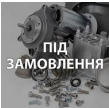













SAECO RUBINO 200 чорна (верхня частина)(10003260 )

	33		11000972	OR 3050 FKM 80 FD PEROXIDICA OR 3050 FKM 80 FD PEROXIDICA
	34		11003749	HEAT ELEMENT FOR BOILER 1000W120V UL RES. X CALDAIA 1000W 120V INOX
	34		11007580	RES CALD. V230 W1000 INC.800 RES CALD. V230 W1000 INC.800
	35		NM04.010	OR ORM 0730-40 FPM 70+-5 IRHDBLACK OR ORM 0730-40 FPM 70 +-5 IRHD NERO
	36		9011.226	LOWER OVERSIZE CASING M6 VENDING UPPER OVERSIZE CASING M6 VENDING
	37		11025409	TUBE ASSEMBLY TEFLON 3X6 L.220MM TUBE ASSEMBLY TEFLON 3X6 L.220MM
	38		11025327	BOILER ASS.RUBINO200 M6 HS1 220/60 TEA BOILER ASS.RUBINO200 M6 HS1 220/60 TEA
	38		11025328	BOILER ASS. M6 SG200 HS1 230V BOILER ASS. M6 SG200 HS1 230V
	38		11025329	ASS.BOILER RUBINO200 230V HS1TEA ASS.BOILER RUBINO200 230V HS1 TEA
	38		11025331	BOILER ASS.SG200 M6 HS1 120V UL BOILER ASS.SG200 M6 HS1 120V UL
	38		11025332	BOILER ASS.SG200 M6 HS1 120V CSA BOILER ASS.SG200 M6 HS1 120V CSA
	39		9111.501	INSULATION WASHER INSULATION WASHER
	40		U324.003	NUT M5 FLANGED INDENTED BASE NUT M5 FLANGED INDENTED BASE
	41		1813.A09.A2A	ASS.COFFEE GRINDER SG200 ASS.MACINACAFFE' MONTATO SG 200

## Model Machine

MACSAE111

SAECO RUBINO 200 чорна (верхня частина)(10003260 )

























	41		<b>1813.A09.A2F</b>	ASS.COFFEE GRINDER SG200 120VUL ASS.COFFEE GRINDER SG200 120V UL
	41		<b>1813.A09.A2N</b>	ASS.COFFEE GRINDER SG200 220V60HZ ASS.COFFEE GRINDER SG200 220V 60HZ
	41		<b>1884.A09.A2R</b>	ASS.COFFEE GRINDER 100V ASS.COFFEE GRINDER 100V
	42		<b>11012026</b>	SUPPORT BOILER HS1 RUBINO200 SUPPORT BOILER HS1 RUBINO200
	43		<b>U044.013</b>	SCREW TSPC M4,0X12 UNI 7688 GALV. VITE TSPC M4,0X12 UNI 7688 ZNP
	44		<b>11006046</b>	PEG FOR BOILER PEG FOR BOILER
	45		<b>11005743</b>	KNURLED FEMALE HAND BOLT M14 GODRONE FEMMINA M14
	46		<b>11005741</b>	CONNECTOR D.6 BOCCOLA ESTERNA D.6
	47		<b>U109.037</b>	SCREW AUT.TCB 4,8X13 DIN 7981C VITE AUT.TCB 4,8X13 DIN 7981 C NIK
	48		<b>140321462</b>	O-RING 2018 SILICONE OR 2018 IN SILICONE
	49		<b>11005370</b>	PIN FOR MUFF PERNO X MANICOTTO PIN FOR MUFF
	50		<b>U302.003</b>	GALV.NUT HEXAGONAL M4 UNI 5589ZN DADO ESAGONALE M4 UNI 5588 ZNP
	51		<b>11013173</b>	OR ORM 0090-20 FKM 80 FD GREENPEROXIDA OR ORM 0090-20 FKM 80 FD GREEN PEROXIDA
	52		<b>9120.002.00A</b>	RATIOMOTOR ASS. DA 3/5P 230V ASS.MOTORIDUTTORE DA 3/5P 230V

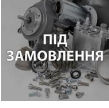

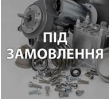
## Model Machine

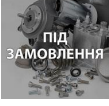
MACSAE111























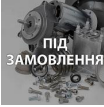

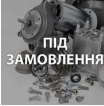

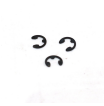
SAECO RUBINO 200 чорна (верхня частина)(10003260 )

	52		9120.002.00F	RATIOMOTOR ASS. DA 3/5P 120V RATIOMOTOR ASS. DA 3/5P 120V
	52		9120.002.00N	RATIOMOTOR ASS. DA 3/5P 220V 60HZ RATIOMOTOR ASS. DA 3/5P 220V 60HZ
	53		11013174	OR ORM 0050-20 FKM 80 FD GREENPEROXIDA OR ORM 0050-20 FKM 80 FD GREEN PEROXIDA
	54		129824002	TCB SCREW M4X10 UNI 7687 ZNP VITE TCB M4X10 UNI 7687 ZNP
	55		128310404	МЕТАЛЕВЕ УБЧАСТЕ КОЛИЩАТКО UNI 8842 A4 WASHER UNI 8842 A4 BURNISHED
	56		129825502	TCB SCREW M4X25 UNI 7687 ZNP TCB SCREW M4X25 UNI 7687 ZNP
	57		9991.037	CAM FOR RATIOMOTOR 1 MICRO CAMMA X MOTORIDUTTORE 1 MICRO
	58		9991.015	PLATE FOR MICRO PIASTRINA X MICRO
	59		U034.003	SCREW TCI M3,0X20 UNI 6107 GALV. SCREW TCI M3,0X20 UNI 6107 GALV.
	60		9991.013	JOINT FOR RATIOMOTOR GIUNTO X MOTORIDUTTORE
	61		9121.008.00A	RATIOMOTOR 30 PACK 230/240V MOTORIDUTTORE PACCO 30 230/240V
	61		9121.008.00F	RATIOMOTOR 30 PACK 120V RATIOMOTOR 30 PACK 120V
	61		9121.008.00N	RATIOMOTOR 30 PACK 220V 60HZ RATIOMOTOR 30 PACK 220V 60HZ

## Model Machine

MACSAE111











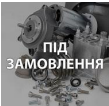















SAECO RUBINO 200 чорна (верхня частина)(10003260 )

	62		<b>U208.002</b>	TOOTHED WASHER 3,3X5,8 UNI 3703 G <i>ROSETTA DENT. 3,3X5,8 UNI 3703 ZNP</i>
	63		<b>U302.002</b>	NUT HEXAGONAL M3 UNI 5588 <i>NUT HEXAGONAL M3 UNI 5588</i>
	64		<b>NE05.002</b>	МІКРОВИМИКАЧ ДЛЯ КАВОМАШИНИ EF83161.8 <i>MICROINTERRUTTORE</i>
	65		<b>9991.014</b>	CARD FOR MICRO SWITCHES <i>CARTONCINO X MICROINTERRUTTORE</i>
	66		<b>U043.007</b>	SCREW TCBC M3,0X8 UNI 7687 GALV. <i>SCREW TCBC M3,0X8 UNI 7687 GALV.</i>
	67		<b>1813.103.A20</b>	RING NUT OF GRIND REGULATION <i>RING NUT OF GRIND REGULATION</i>
	68		<b>1813.637</b>	HARNESS <i>HARNESS</i>
	68		<b>1813.651</b>	HARNESS <i>HARNESS</i>
	69		<b>U701.011</b>	STEEL SNAP RING 5 UNI 7434 <i>ANELLO ELASTICO 5 UNI 7434</i>
	70		<b>1813.045.A20</b>	GRIND SUPPORT <i>GRIND SUPPORT</i>
	71		<b>1813.046.050</b>	RUBBER GRIND SUPPORT <i>RUBBER GRIND SUPPORT</i>
	72		<b>1813.097.A20</b>	SPACER <i>SPACER</i>
	73		<b>1813.177</b>	SUPPORT SEAL <i>SUPPORT SEAL</i>
	74		<b>U044.022</b>	SCREW TSPC M5,0X8 UNI 7688 GALV. <i>SCREW TSPC M5,0X8 UNI 7688 GALV.</i>

## Model Machine

MACSAE111













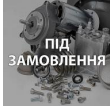

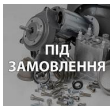





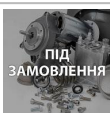

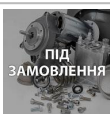

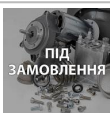
SAECO RUBINO 200 чорна (верхня частина)(10003260 )

	75		1813.158	STICKER <i>STICKER</i>
	76		1813.159	ANTIVIBRATION RUBBER <i>ANTIVIBRATION RUBBER</i>
	77		NF11.002	SELF LOCK STRIP W=2.5 L=98 <i>SELF LOCK STRIP W=2.5 L=98</i>
	78		1813.104.A20	ADJUSTMENT SCREW WITH TUBE HOLDER <i>VITE REGOLAZIONE MACININO</i>
	79		9141.008	KNOB ADJUSTMENT SCREW <i>KNOB ADJUSTMENT SCREW</i>
	80		140321560	O-RING 3187 NBR <i>OR 3187 IN NBR</i>
	81		9141.081	МЕТАЛЕВИЙ ПОДРІБНЮВАЧ D.43 TIN SAECO (1 ШТ) <i>MACINA PIANA D.43 TIN NB) PREZZO ACQUISTO PER 1 PEZZO</i>
	82		9141.001	BRASS INCREMENT SCREW MC <i>BRASS INCREMENT SCREW MC</i>
	83		129761402	TC SCREW M3X8 UNI 6107 ZNP <i>TC SCREW M3X8 UNI 6107 ZNP</i>
	84		U043.004	ZN-B TCB TORX 20 M4X16 ZN-B <i>VITE TCBC M4,0X16 UNI 7687 ZNP</i>
	85		U203.001	ШАЙБА 4,3X8 UNI 1749 GA <i>PLAIN WASHER 4,3X8 UNI 1749 GAL</i>
	86		9141.003	SPACER FOR RUBBER <i>SPACER FOR RUBBER</i>
	87		9991.005	RUBBER FOR COFFEE GRINDER <i>GOMMINO X MACINA CAFFE</i>
	88		9140.001.00A	COFFEGRINDER MOTOR ASS.220/230V <i>ASS.MOTORE MACINACAFFE'220/2</i>

## Model Machine

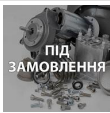
MACSAE111

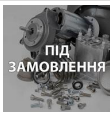

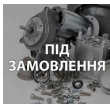







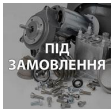





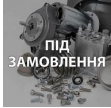

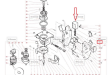

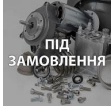



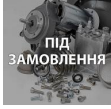

SAECO RUBINO 200 чорна (верхня частина)(10003260 )

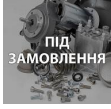
	88		<b>9140.001.00F</b>	COFFEGRINDER MOTOR ASS.120V <i>COFFEGRINDER MOTOR ASS.120V</i>
	88		<b>9140.001.00N</b>	COFFEGRINDER MOTOR ASS.220 60HZ UL <i>COFFEGRINDER MOTOR ASS.220 60HZ UL</i>
	88		<b>9140.001.00R</b>	COFFEGRINDER MOTOR ASS.100V 50/60HZ <i>COFFEGRINDER MOTOR ASS.100V 50/60HZ</i>
	89		<b>9141.007</b>	FAN <i>VENTOLINA</i>
	90		<b>9140.002.00A</b>	MOTOR ASS.WITH CAP 230V <i>ASS.MOTORE CON CALOTTA 230V</i>
	90		<b>9140.002.00F</b>	MOTOR ASS.WITH CAP 120V <i>MOTOR ASS.WITH CAP 120V</i>
	90		<b>9140.002.00N</b>	MOTOR ASS.WITH CAP 220V 60HZ UL <i>MOTOR ASS.WITH CAP 220V 60HZ UL</i>
	90		<b>9140.002.00R</b>	MOTOR ASS.WITH CAP 100V 50/60HZ <i>MOTOR ASS.WITH CAP 100V 50/60HZ</i>
	91		<b>9141.005</b>	KNOB PIN <i>PERNO MANOPOLA</i>
	92		<b>126769118</b>	SPRING FOR KNOB STOP PIN (H=19) <i>SPRING FOR KNOB STOP PIN (H=19)</i>
	93		<b>1813.A10.A2A</b>	DOSER ASS. 6-11 GR. <i>ASS.DOSATORE 6-11 GR.</i>
	93		<b>1813.A10.A2F</b>	DOSER ASS. 6-11 GR.120V UL <i>DOSER ASS. 6-11 GR.120V UL</i>
	93		<b>1813.A10.A2N</b>	DOSER ASS. 6-11 GR. 220V 60HZ <i>DOSER ASS. 6-11 GR. 220V 60HZ</i>

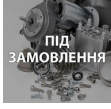
## Model Machine

MACSAE111

















SAECO RUBINO 200 чорна (верхня частина)(10003260 )

	93		<b>1884.A10.A2R</b>	DOSER ASS. 6-11 GR.100V <i>DOSER ASS. 6-11 GR.100V</i>
	94		<b>129851921</b>	TSP SCREW M3X6 UNI 7688 SS <i>TSP SCREW M3X6 UNI 7688 SS</i>
	95		<b>9121.235.00A</b>	ELECTROMAGNET FOR DISPENSER WITH NUCLEUS <i>ELETTROM. PER DOSATORE CON NUCLEO</i>
	95		<b>9121.235.00F</b>	ELECTROMAGNET X DISPENSER W/NUCLEUS 120V <i>ELECTROMAGNET X DISPENSER W/NUCLEUS 120V</i>
	95		<b>9121.235.00N</b>	ЕЛЕКТРОМАГНІТ ДЛЯ ДОЗАТОРА W/NUCLEUS 220V <i>ELECTROMAGNET X DISPENSER W/NUCLEUS 220V</i>
	95		<b>9121.235.00R</b>	ELECTROMAGNET X DISPENSER W/NUCLEUS 100V <i>ELECTROMAGNET X DISPENSER W/NUCLEUS 100V</i>
	96		<b>1813.042.A20</b>	DISPENSER PALLET <i>DISPENSER PALLET</i>
	97		<b>1813.040.A20</b>	DISPENSER SHELL <i>GUSCIO DOSATORE</i>
	98		<b>NE15.003</b>	MALE TONGUE PLAIN 6,3 D.5,2 <i>LINGUETTA MASCHIO PIANA 6,3 D.5,2</i>
	99		<b>U043.020</b>	SCREW TCBC M3,0X6 UNI 7687 GALV. <i>VITE TCBC M3,0X6 UNI 7687 Z</i>
	10001		<b>U116.004</b>	SCREW AUT.PT TCB 3,0X16 WN 1441 <i>SCREW AUT.PT TCB 3,0X16 WN 1441</i>
	1010		<b>NE05.062</b>	MICROSWITCH + WHEEL <i>MICROINTERRUTTORE C/ROTELLA</i>
	1020		<b>1813.127</b>	SPRING FOR ELECTROMAGNET <i>MOLLA X ELETTROMAGNETE DOSAT</i>
	1030		<b>1813.092</b>	PIN <i>PIN</i>

## Model Machine

MACSAE111

SAECO RUBINO 200 чорна (верхня частина)(10003260 )

	1040		1813.043.A20	DISPENSER REGULATION <i>REGOLATORE DOSATORE</i>
	1050		1813.091	PIN FOR DISPENSER REGULATION <i>PIN FOR DISPENSER REGULATION</i>
	1060		1813.078.A20	ADJUSTMENT LEVER <i>ADJUSTMENT LEVER</i>
	1070		1813.044.A20	PALLET FOR REGULATION <i>PALETTA X REGOLATORE</i>
	1080		1813.041.A20	OUTSIDE SHELL DISPENSER <i>OUTSIDE SHELL DISPENSER</i>
	1090		129514003	SCREW TCB 2,9X22,2 DIN 7981 NICK <i>SCREW TCB 2,9X22,2 DIN 7981 NICK</i>
	1100		1813.191.A20	DISPENSER COVER <i>COPERTURA DOSATORE</i>
	1110		U043.011	SCREW TCBC M4,0X12 UNI 7687 GALV. <i>SCREW TCBC M4,0X12 UNI 7687 GALV.</i>

# Model Machine

MACSAE111

SAECO RUBINO 200 чорна (верхня частина)(10003260 )



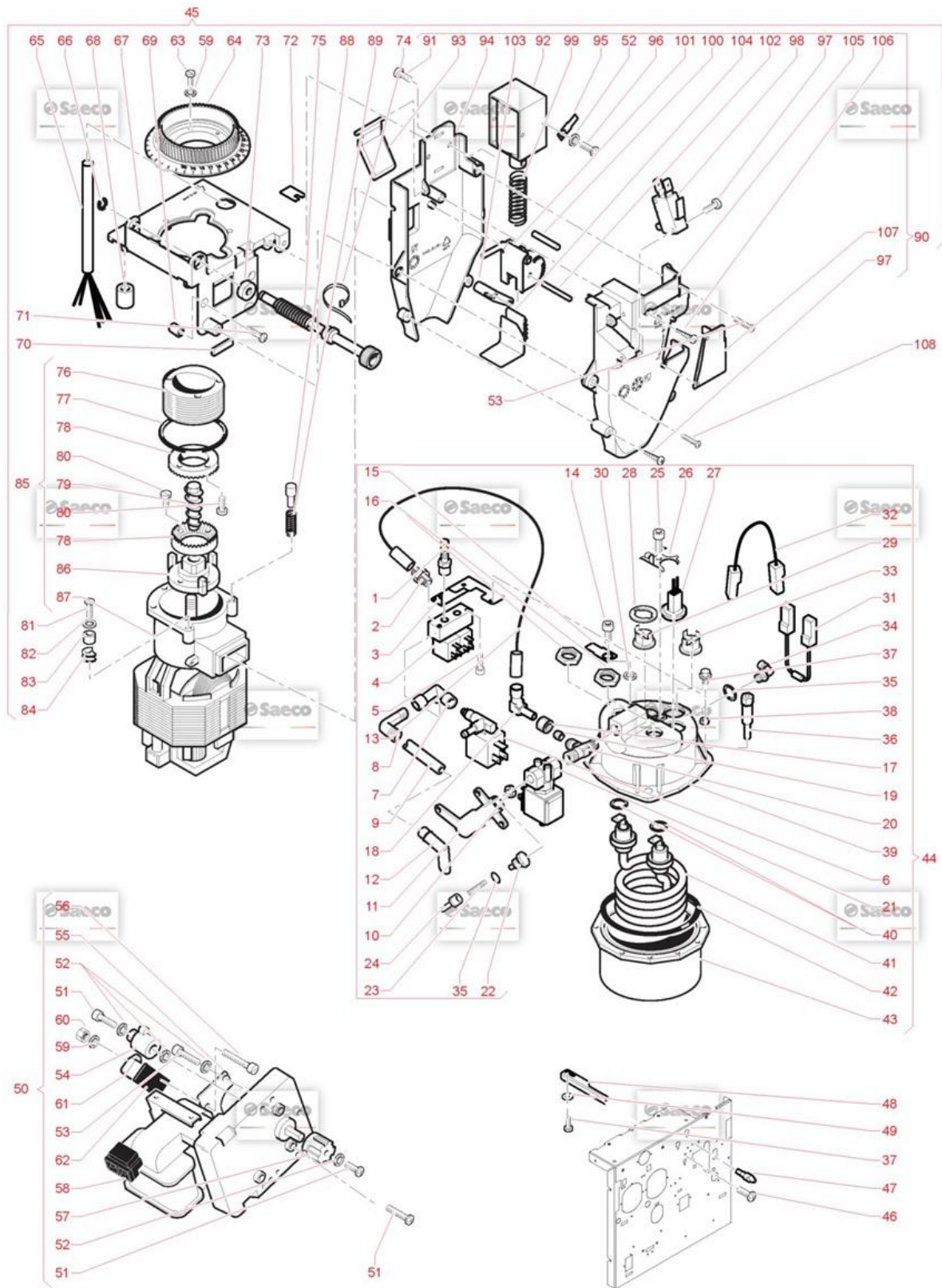























MACSAE111.T.0008



## Model Machine

MACSAE111

SAECO RUBINO 200 чорна (верхня частина)(10003260 )











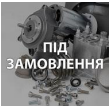















Web	Pos.	Foto	Item - Replace by	Description
				<i>Press - CTRL + CLICK go to item in a new window Натисніть - Ctrl + права кнопка миші щоб відкрити запчастину в новому вікні</i>
	1		NR07.047	RUBBER HOLDER COUPLING 1/8 CONICAL <i>INNESTO PORTAGOMMA 1/8 CONICO</i>
	2		11000241	CONNECTOR <i>CONNECTOR</i>
	2		9991.133	STRAIGHT CONN. 1/8 D6 WITH OR <i>RACCORDO DIRITTO 1/8 D6 CON OR</i>
	3		11005264	SOLENOID VALVE SUPPORT PLATE STEEL <i>SOLENOID VALVE SUPPORT PLATE STEEL</i>
	4		11000838	BLOCK ELECTROVALVE 100V <i>BLOCK ELECTROVALVE 100V</i>
	4		9121.221.00A	BLOCK ELECTROVALVE <i>BLOCCHETTO ELETTRORVALVOLE 2</i>
	4		9121.221.00F	BLOCK ELECTROVALVE <i>BLOCK ELECTROVALVE</i>
	4		9121.221.00N	BLOCK ELECTROVALVE <i>BLOCK ELECTROVALVE</i>
	5		U023.010	SCREW TCEI M4,0X16 UNI 5931 BURN. <i>VITE TCEI M4,0X16 UNI 5931 BRU</i>
	6		9121.036.00A	2 WAY SOLENOID VALVE 230V <i>ELETTRORVALVOLA 2 VIE 230V</i>
	6		9121.036.00F	2 WAY SOLENOID VALVE 120V <i>2 WAY SOLENOID VALVE 120V</i>
	7		9181.317	RACCORDO 3 VIE FEMMINA 1/8";"RACCORDO 3 VIE FEMMINA 1/8"" <i>RACCORDO 3 VIE FEMMINA 1/8"</i>
	8		9181.337	DOUBLE-CONE JOINT A L M 1/8X06NICK <i>DOUBLE-CONE JOINT A L M 1/8X06 NICK</i>



## Model Machine

MACSAE111

















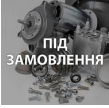





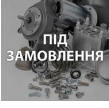

SAECO RUBINO 200 чорна (верхня частина)(10003260 )

	9	 ПІД ЗАМОВЛЕННЯ	11022517	SILICONE TUBE 5X8 L 630MM <i>SILICONE TUBE 5X8 L 630MM</i>
	10		9991.035	NUT 1/8 H 4.5 <i>DADO 1/8 H.4,5</i>
	11		9161.213	BOILER TEFLON SUPPORT <i>BOILER TEFLON SUPPORT</i>
	11	 ПІД ЗАМОВЛЕННЯ	9161.271	BRASS BOILER SUPPORT NIK <i>BRASS BOILER SUPPORT NIK</i>
	12	 ПІД ЗАМОВЛЕННЯ	11004711	NOZZLES <i>NOZZLES</i>
	13	 ПІД ЗАМОВЛЕННЯ	11000243	ASS.TUBE TEFLON 4X6 L.170MM 1/8"1/8" NIK <i>ASS.TUBE TEFLON 4X6 L.170MM 1/8"1/8" NIK</i>
	13	 LIBERTY	9979.A29	TEFLON TUBE ASS. 4X6 L.170 1/8" 1/8 <i>ASS.TUBO TEFLON 4X6 L.170 1/8 1/8</i>
	14		U023.020	SCREW TCEI M6X20 UNI 5931 ZIN <i>VITE TCEI M6X20 UNI 5931 8.8</i>
	15		NE15.031	MALE TONGUE PLAIN 6,3 D.6,3 <i>MALE TONGUE PLAIN 6,3 D.6,3</i>
	16		9991.029	NUT FOR RESISTOR <i>DADO X RESISTENZA</i>
	17		9991.007	NUT FOR CONNECTOR 1/8" <i>NUT FOR CONNECTOR 1/8 NUOVO PREZZO 0,89</i>
	18		11000242	RACCORDO SNODATO A "L" GAS M-FTEA <i>CONNECTOR</i>
	19	 ПІД ЗАМОВЛЕННЯ	9111.403	ROTATING ELBOW CONNECTOR M1/8D.6 <i>RACCORDO A GOMITO ORIENT. M1/8 D.6</i>
	19		9991.008	ЗОВНІШНЯ ОБЖИМКА Д,6 SAECO 121800420 BIANCHI 19046526 <i>EXTERNAL BUSH D.6</i>

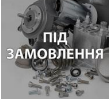
## Model Machine

MACSAE111



















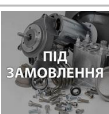







SAECO RUBINO 200 чорна (верхня частина)(10003260 )

	20		9991.211	"T" CONNECTOR FOR BOILER;"T""CONNECTOR FOR BOILER <i>RACCORDO A T X CALDAIA</i>
	20		9991.213	CONNECTOR "T" FOR BOILER <i>CONNECTOR "T" FOR BOILER</i>
	21		9121.138.00A	ELECTROVALVE COFFEE GROUP 230V <i>ELETTROVALVOLA GRUPPO CAFFE'</i>
	21		9121.138.00F	ELECTROVALVE COFFEE GROUP 120V60HZ <i>ELECTROVALVE COFFEE GROUP 120V 60HZ</i>
	21		9121.138.00R	ELECTROVALVE COFFEE GROUP 110V50/60HZ <i>ELECTROVALVE COFFEE GROUP 110V 50/60HZ</i>
	22		9991.212	CONNECTOR BOILER SUPPORT <i>RACCORDO SUPPORTO CALDAIA</i>
	22		9991.214	CONNECTOR NIK BOILER SUPPORT <i>RACCORDO SUPPORTO CALDAIA NIK</i>
	23		126765317	STEEL SPRING BOILER PISTON MAGIC <i>STEEL SPRING BOILER PISTON MAGIC</i>
	24		9019.A01	PIN ASS. <i>PIN ASS.</i>
	24		9019.A20	PIN ASS. BRASS NIK <i>PIN ASS. BRASS NIK</i>
	25		12001052	SCREW TCEI M4,0X6 DIN 912 ZIN <i>SCREW TCEI M4,0X6 DIN 912 ZIN</i>
	25		U043.012	SCREW TCB TORX 20 M4X6 ZN-B <i>VITE TCBC M4,0X6 UNI 7687 Z</i>
	26		226830200	RETAIN.SPRING 3 THERM. +THERMAL FUSE <i>RETAIN.SPRING 3 THERM. +THERMAL FUSE</i>

## Model Machine

MACSAE111



























SAECO RUBINO 200 чорна (верхня частина)(10003260 )

	27		11000076	ASS.SENSOR 8P UL ASS.SENSOR 8P UL
	27		11000316	ASSEMBLY HORIZONTAL SENSOR SG200 ASSEMBLY HORIZONTAL SENSOR SG200
	28		9991.085	THERMOSTAT FIXING WASHER RONDELLA FERMATERMOSTATI
	29		NE09.021	THERMOSTAT 150°NC FASTON 90° THERMOSTATO 150°NC FASTON 90°
	30		U204.001	ELAS. WASHER 6,4X11,4 UNI 1751ZIN ELAS. WASHER 6,4X11,4 UNI 1751 ZIN
	31		0862.699	THERMAL FUSE HARNESS UL THERMAL FUSE HARNESS UL
	31		0894.618	THERMAL FUSE HARNESS CABLAGGIO TERMOFUSIBILE
	32		1813.628	HARNESS CABLAGGIO PROTEZIONE TERMICA
	32		1813.643	HARNESS HARNESS
	33		189428700	THERMOSTAT 175° 1NT-15L-5126 THERMOSTAT 175° 1NT-15L-5126
	34		11025082	1/8"G M/CONICAL ORIENT. NUT/OGV 1/8G M/CONICAL ORIENT. NUT/OGV
	34		NR05.030	BICONIC. CONN. L M 1/8X06 SS BICONIC. CONN. L M 1/8X06 SS
	34		NR10.014	МЕТАЛЕВИЙ ПЕРЕХІДНИК 1/8" D.6 RACCORDO 1/8" D.6 ORIENTABILE COD. OLAB
	35		140321462	O-RING 2018 SILICONE OR 2018 IN SILICONE

## Model Machine

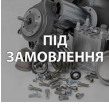
MACSAE111

















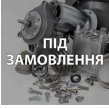





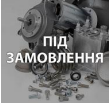

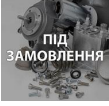
SAECO RUBINO 200 чорна (верхня частина)(10003260 )

	36		9111.576	LOWER CASING UPPER PART FIXINGPIN <i>PERNO FISSAGGIO CORPO INF./SUP. M6</i>
	37		U046.005	SCREW TE M5,0X10 WITH WASHER <i>SCREW TE M5,0X10 WITH WASHER</i>
	38		U324.006	NUT M4 FLANGED INDENTED BASE <i>NUT M4 FLANGED INDENTED BASE</i>
	39		11002259	UPPER DOSER CASING M6 TEA <i>UPPER DOSER CASING M6 TEA</i>
	40		11000972	OR 3050 FKM 80 FD PEROXIDICA <i>OR 3050 FKM 80 FD PEROXIDICA</i>
	41		11003723	HEAT ELEMENT BOILER 100V <i>HEAT ELEMENT BOILER 100V</i>
	41		11003749	HEAT ELEMENT FOR BOILER 1000W120V UL <i>RES. X CALDAIA 1000W 120V INOX</i>
	41		11007580	RES CALD. V230 W1000 INC.800 <i>RES CALD. V230 W1000 INC.800</i>
	41		9011.255.00A	RES CALD.V230 W1000 <i>RES.CALD. 230V 1000W</i>
	42		NM04.010	OR ORM 0730-40 FPM 70+-5 IRHDBLACK <i>OR ORM 0730-40 FPM 70 +-5 IRHD NERO</i>
	43		9011.226	LOWER OVERSIZE CASING M6 VENDING <i>UPPER OVERSIZE CASING M6 VENDING</i>
	44		11003970	BOILER ASS.SG200 M6 "T" 120V UL <i>BOILER ASS.SG200 M6 "T" 120V UL</i>
	44		11008887	BOILER ASS.RUBINO200TTT 120V UL <i>BOILER ASS.RUBINO200TTT 120V UL</i>
	44		11010578	BOILER ASS. M6 230V <i>BOILER ASS. M6 SG200 230V</i>

## Model Machine

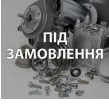
MACSAE111











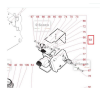



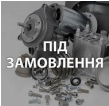











SAECO RUBINO 200 чорна (верхня частина)(10003260 )

	44		<b>11012447</b>	BOILER ASS. M6 RUBINO200 220VTEA <i>BOILER ASS. M6 RUBINO200 220V TEA</i>
	44		<b>11012448</b>	BOILER ASS.DA RUBINO200 "T" 100V TEA <i>BOILER ASS.DA RUBINO200 "T" 100V TEA</i>
	44		<b>11025330</b>	BOILER ASS.RUBINO200TTT 230V TEA <i>BOILER ASS.RUBINO200TTT 230V TEA</i>
	44		<b>11025333</b>	BOILER ASS.RUBINO200TTT 120V TEA <i>BOILER ASS.RUBINO200TTT 120V TEA</i>
	45		<b>1813.A09.A2A</b>	ASS.COFFEE GRINDER SG200 <i>ASS.MACINACAFFE' MONTATO SG 200</i>
	45		<b>1813.A09.A2F</b>	ASS.COFFEE GRINDER SG200 120VUL <i>ASS.COFFEE GRINDER SG200 120V UL</i>
	45		<b>1813.A09.A2N</b>	ASS.COFFEE GRINDER SG200 220V60HZ <i>ASS.COFFEE GRINDER SG200 220V 60HZ</i>
	45		<b>1884.A09.A2R</b>	ASS.COFFEE GRINDER 100V <i>ASS.COFFEE GRINDER 100V</i>
	46		<b>U044.013</b>	SCREW TSPC M4,0X12 UNI 7688 GALV. <i>VITE TSPC M4,0X12 UNI 7688 ZNP</i>
	47		<b>9011.005</b>	PEG FOR BOILER <i>PERNO X CALDAIA</i>
	48		<b>1883.001</b>	BOILER SUPPORT BRACKET "T" <i>BOILER SUPPORT BRACKET "T"</i>
	49		<b>U207.001</b>	PLAIN WASHER 5,3X10 UNI 6592 GAL <i>ROSETTA PIANA 5,3X10 UNI 6</i>
	50		<b>11007284</b>	ASS.RATIOMOTOR FRESH BREW 120VUL <i>ASS.RATIOMOTOR FRESH BREW 120V UL</i>

## Model Machine

MACSAE111

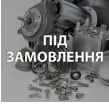









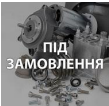

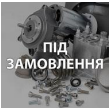













SAECO RUBINO 200 чорна (верхня частина)(10003260 )

	50		11007285	МОТОРЕДУКТОР ВЗБОРІ 230V ASS.RATIOMOTOR FRESH BREW 230V
	50		9120.002.00A	RATIOMOTOR ASS. DA 3/5P 230V ASS.MOTORIDUTTORE DA 3/5P 230V
	50		9120.002.00F	RATIOMOTOR ASS. DA 3/5P 120V RATIOMOTOR ASS. DA 3/5P 120V
	50		9120.002.00N	RATIOMOTOR ASS. DA 3/5P 220V 60HZ RATIOMOTOR ASS. DA 3/5P 220V 60HZ
	50		9120.002.00R	RATIOMOTOR ASS. DA 3/5P 100V RATIOMOTOR ASS. DA 3/5P 100V
	51		129824002	TCB SCREW M4X10 UNI 7687 ZNP VITE TCB M4X10 UNI 7687 ZNP
	52		128310404	МЕТАЛЕВЕ УБЧАСТЕ КОЛИЩАТКО UNI 8842 A4 WASHER UNI 8842 A4 BURNISHED
	53		129825502	TCB SCREW M4X25 UNI 7687 ZNP TCB SCREW M4X25 UNI 7687 ZNP
	54		11003525	CAM COFFEE GROUP FRESH BREW CAM COFFEE GROUP FRESH BREW
	54		9991.037	CAM FOR RATIOMOTOR 1 MICRO CAMMA X MOTORIDUTTORE 1 MICRO
	55		11003524	PLATE FOR MICRO RATIOMOTOR PLATE FOR MICRO RATIOMOTOR
	55		9991.015	PLATE FOR MICRO PIASTRINA X MICRO
	56		U034.003	SCREW TCI M3,0X20 UNI 6107 GALV. SCREW TCI M3,0X20 UNI 6107 GALV.
	57		9991.013	JOINT FOR RATIOMOTOR GIUNTO X MOTORIDUTTORE

## Model Machine

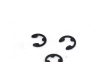
MACSAE111























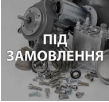

SAECO RUBINO 200 чорна (верхня частина)(10003260 )

	58		<b>9121.008.00A</b>	RATIOMOTOR 30 PACK 230/240V <i>MOTORIDUTTORE PACCO 30 230/240V</i>
	58		<b>9121.008.00F</b>	RATIOMOTOR 30 PACK 120V <i>RATIOMOTOR 30 PACK 120V</i>
	58		<b>9121.008.00N</b>	RATIOMOTOR 30 PACK 220V 60HZ <i>RATIOMOTOR 30 PACK 220V 60HZ</i>
	59		<b>U208.002</b>	TOOTHED WASHER 3,3X5,8 UNI 3703 G <i>ROSETTA DENT. 3,3X5,8 UNI 3703 ZNP</i>
	60		<b>U302.002</b>	NUT HEXAGONAL M3 UNI 5588 <i>NUT HEXAGONAL M3 UNI 5588</i>
	61		<b>NE05.002</b>	МІКРОВИМИКАЧ ДЛЯ КАВОМАШИНИ EF83161.8 <i>MICROINTERRUTTORE</i>
	62		<b>9991.014</b>	CARD FOR MICRO SWITCHES <i>CARTONCINO X MICROINTERRUTTORE</i>
	63		<b>U043.007</b>	SCREW TCBC M3,0X8 UNI 7687 GALV. <i>SCREW TCBC M3,0X8 UNI 7687 GALV.</i>
	64		<b>1813.103.A20</b>	RING NUT OF GRIND REGULATION <i>RING NUT OF GRIND REGULATION</i>
	65		<b>1813.637</b>	HARNESS <i>HARNESS</i>
	65		<b>1813.651</b>	HARNESS <i>HARNESS</i>
	66		<b>U701.011</b>	STEEL SNAP RING 5 UNI 7434 <i>ANELLO ELASTICO 5 UNI 7434</i>
	67		<b>1813.045.A20</b>	GRIND SUPPORT <i>GRIND SUPPORT</i>
	68		<b>1813.046.050</b>	RUBBER GRIND SUPPORT <i>RUBBER GRIND SUPPORT</i>

## Model Machine

MACSAE111

SAECO RUBINO 200 чорна (верхня частина)(10003260 )





























	69		1813.097.A20	SPACER SPACER
	70		1813.177	SUPPORT SEAL SUPPORT SEAL
	71		U044.022	SCREW TSPC M5,0X8 UNI 7688 GALV. SCREW TSPC M5,0X8 UNI 7688 GALV.
	72		1813.158	STICKER STICKER
	73		1813.159	ANTIVIBRATION RUBBER ANTIVIBRATION RUBBER
	74		NF11.002	SELF LOCK STRIP W=2.5 L=98 SELF LOCK STRIP W=2.5 L=98
	75		1813.104.A20	ADJUSTMENT SCREW WITH TUBE HOLDER VITE REGOLAZIONE MACININO
	76		9141.008	KNOB ADJUSTMENT SCREW KNOB ADJUSTMENT SCREW
	77		140321560	O-RING 3187 NBR OR 3187 IN NBR
	78		9141.081	МЕТАЛЕВИЙ ПОДРІБНЮВАЧ D.43 TIN SAECO (1 ШТ) MACINA PIANA D.43 TIN NB) PREZZO ACQUISTO PER 1 PEZZO
	79		9141.001	BRASS NCREMENT SCREW MC BRASS NCREMENT SCREW MC
	80		129761402	TC SCREW M3X8 UNI 6107 ZNP TC SCREW M3X8 UNI 6107 ZNP
	81		U043.004	ZN-B TCB TORX 20 M4X16 ZN-B VITE TCBC M4,0X16 UNI 7687 ZNP



## Model Machine

MACSAE111











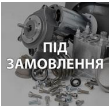

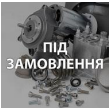













SAECO RUBINO 200 чорна (верхня частина)(10003260 )

	82		U203.001	ШАЙБА 4,3X8 UNI 1749 GA PLAIN WASHER 4,3X8 UNI 1749 GAL
	83		9141.003	SPACER FOR RUBBER SPACER FOR RUBBER
	84		9991.005	RUBBER FOR COFFEE GRINDER GOMMINO X MACINA CAFFE
	85		9140.001.00A	COFFEGRINDER MOTOR ASS.220/230V ASS.MOTORE MACINACAFFE'220/2
	85		9140.001.00F	COFFEGRINDER MOTOR ASS.120V COFFEGRINDER MOTOR ASS.120V
	85	 ПІД ЗАМОВЛЕННЯ	9140.001.00N	COFFEGRINDER MOTOR ASS.220 60HZ UL COFFEGRINDER MOTOR ASS.220 60HZ UL
	85	 ПІД ЗАМОВЛЕННЯ	9140.001.00R	COFFEGRINDER MOTOR ASS.100V 50/60HZ COFFEGRINDER MOTOR ASS.100V 50/60HZ
	86		9141.007	FAN VENTOLINA
	87		9140.002.00A	MOTOR ASS.WITH CAP 230V ASS.MOTORE CON CALOTTA 230V
	87	 ПІД ЗАМОВЛЕННЯ	9140.002.00F	MOTOR ASS.WITH CAP 120V MOTOR ASS.WITH CAP 120V
	87	 ПІД ЗАМОВЛЕННЯ	9140.002.00N	MOTOR ASS.WITH CAP 220V 60HZ UL MOTOR ASS.WITH CAP 220V 60HZ UL
	87	 ПІД ЗАМОВЛЕННЯ	9140.002.00R	MOTOR ASS.WITH CAP 100V 50/60HZ MOTOR ASS.WITH CAP 100V 50/60HZ
	88		9141.005	KNOB PIN PERNO MANOPOLA
	89		126769118	SPRING FOR KNOB STOP PIN (H=19) SPRING FOR KNOB STOP PIN (H=19)

## Model Machine

MACSAE111





















SAECO RUBINO 200 чорна (верхня частина)(10003260 )

	90		<b>1813.A10.A2A</b>	DOSER ASS. 6-11 GR. <i>ASS.DOSATORE 6-11 GR.</i>
	90		<b>1813.A10.A2F</b>	DOSER ASS. 6-11 GR.120V UL <i>DOSER ASS. 6-11 GR.120V UL</i>
	90		<b>1813.A10.A2N</b>	DOSER ASS. 6-11 GR. 220V 60HZ <i>DOSER ASS. 6-11 GR. 220V 60HZ</i>
	90		<b>1884.A10.A2R</b>	DOSER ASS. 6-11 GR.100V <i>DOSER ASS. 6-11 GR.100V</i>
	91		<b>129851921</b>	TSP SCREW M3X6 UNI 7688 SS <i>TSP SCREW M3X6 UNI 7688 SS</i>
	92		<b>9121.235.00A</b>	ELECTROMAGNET FOR DISPENSER WITH NUCLEUS <i>ELETTROM. PER DOSATORE CON NUCLEO</i>
	92		<b>9121.235.00F</b>	ELECTROMAGNET X DISPENSER W/NUCLEUS 120V <i>ELECTROMAGNET X DISPENSER W/NUCLEUS 120V</i>
	92		<b>9121.235.00N</b>	ЕЛЕКТРОМАГНІТ ДЛЯ ДОЗАТОРА W/NUCLEUS 220V <i>ELECTROMAGNET X DISPENSER W/NUCLEUS 220V</i>
	92		<b>9121.235.00R</b>	ELECTROMAGNET X DISPENSER W/NUCLEUS 100V <i>ELECTROMAGNET X DISPENSER W/NUCLEUS 100V</i>
	93		<b>1813.042.A20</b>	DISPENSER PALLET <i>DISPENSER PALLET</i>
	94		<b>1813.040.A20</b>	DISPENSER SHELL <i>GUSCIO DOSATORE</i>
	95		<b>NE15.003</b>	MALE TONGUE PLAIN 6,3 D.5,2 <i>LINGUETTA MASCHIO PIANA 6,3 D.5,2</i>
	96		<b>U043.020</b>	SCREW TCBC M3,0X6 UNI 7687 GALV. <i>VITE TCBC M3,0X6 UNI 7687 Z</i>
	97		<b>U116.004</b>	SCREW AUT.PT TCB 3,0X16 WN 1441 <i>SCREW AUT.PT TCB 3,0X16 WN 1441</i>

## Model Machine

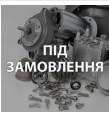
MACSAE111

SAECO RUBINO 200 чорна (верхня частина)(10003260 )

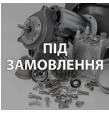
	98		NE05.062	MICROSWITCH + WHEEL <i>MICROINTERRUTTORE C/ROTELLA</i>
	99		1813.127	SPRING FOR ELECTROMAGNET <i>MOLLA X ELETTROMAGNETE DOSAT</i>
	10001		1813.092	PIN <i>PIN</i>
	1010		1813.043.A20	DISPENSER REGULATION <i>REGOLATORE DOSATORE</i>
	1020		1813.091	PIN FOR DISPENSER REGULATION <i>PIN FOR DISPENSER REGULATION</i>
	1030		1813.078.A20	ADJUSTMENT LEVER <i>ADJUSTMENT LEVER</i>
	1040		1813.044.A20	PALLET FOR REGULATION <i>PALETTA X REGOLATORE</i>
	1050		1813.041.A20	OUTSIDE SHELL DISPENSER <i>OUTSIDE SHELL DISPENSER</i>
	1060		129514003	SCREW TCB 2,9X22,2 DIN 7981 NICK <i>SCREW TCB 2,9X22,2 DIN 7981 NICK</i>
	1070		1813.191.A20	DISPENSER COVER <i>COPERTURA DOSATORE</i>
	1080		U043.011	SCREW TCBC M4,0X12 UNI 7687 GALV. <i>SCREW TCBC M4,0X12 UNI 7687 GALV.</i>

# Model Machine

MACSAE111

SAECO RUBINO 200 чорна (верхня частина)(10003260 )

MACSAE111.T.0009

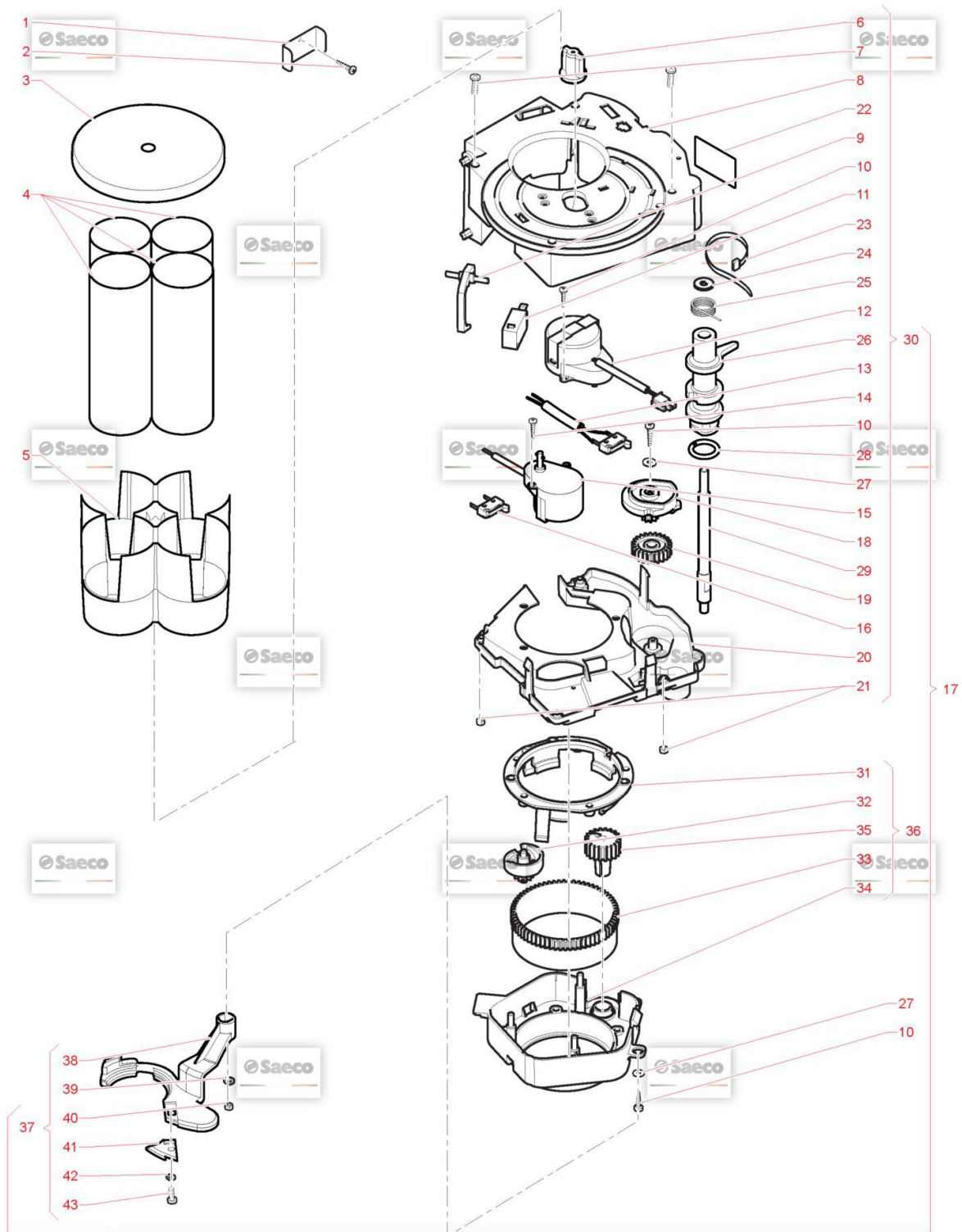

## Model Machine

MACSAE111







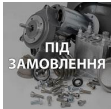

SAECO RUBINO 200 чорна (верхня частина)(10003260 )

Web Pos. Foto Item - Replace by Description

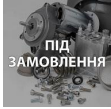
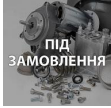

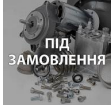
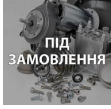
Press - CTRL + CLICK go to item in a new window

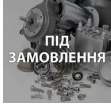
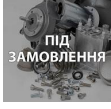
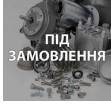



























Натисніть - Ctrl + права кнопка миші щоб відкрити запчастину в новому вікні

	1		1813.162	BRACKET STOP DISPENCER <i>BRACKET STOP DISPENCER</i>
	2		U116.006	SCREW AUT.PT TCB 3,5X12 WN 1441 ZNP <i>VITE AUT.PT TCB 3,5X12 WN 1441 ZNP</i>
	3		1813.161.A20	TANK LID <i>COPERCHIO SERBATOIO BICCHIER</i>
	4		1813.117	TUBE D.80 X 1,5 L=235 MM <i>TUBE D.80 X 1,5 L=235 MM</i>
	5		11000976	TANK DRINKS <i>SERBATOIO BICCHIERI UNIFICATO</i>
	5		1813.076.050	TANK DRINKS <i>TANK DRINKS</i>
	6		11000640	COUPLING FOR MOTOR <i>GIUNTO PER MOTORE CESTELLO</i>
	7		U034.001	SCREW TCI M3,0X30 UNI 6107 GALV. <i>VITE TCI M3,0X30 UNI 6107 ZNP</i>
	8		11000785	ВЕРХНІЙ КОРПУС БЛОКУ ВИДАЧІ СТАКАНІВ <i>CORPO SUPERIORE DISTRIBUTORE BICCHIERI</i>
	8		11000868	CASING UPPER CUP DISTRIBUTOR UL <i>CASING UPPER CUP DISTRIBUTOR UL</i>
	8		1813.061.A20	UPPER CASING DISPENSER GLASSES <i>UPPER CASING DISPENSER GLASSES</i>
	8		1813.307.050	UPPER CASING DISPENSER GLASSESUL <i>UPPER CASING DISPENSER GLASSES UL</i>
	9		1813.067.A20	LEVER <i>LEVA PRESENZA BICCHIERI</i>

## Model Machine

MACSAE111

















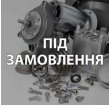





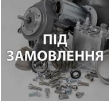

SAECO RUBINO 200 чорна (верхня частина)(10003260 )

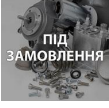
	10		<b>U116.005</b>	SCREW AUT.PT TCB 3,0X8 WN 1441 <i>VITE AUT.PT TCB 3,0X8 WN 1441 ZNP</i>
	11		<b>NE05.065</b>	MICROSWITCH CHERRY D41R-QGAD_61 <i>MICROINTERRUPTORE CHERRY D419Q1A ATLANTE CRISTALLO NEXTAGE</i>
	12		<b>9121.225.00A</b>	MOTOR SAIA UDS 3.3 RPM 220V <i>MOTORE SAIA UDS 3.3 RPM 220V</i>
	12		<b>9121.225.00F</b>	RATIOMOTOR SAIA UDS 3RPM 120V60HZ <i>RATIOMOTOR SAIA UDS 3RPM 120V 60HZ</i>
	12		<b>9121.225.00R</b>	MOTOR SAIA UDS 3.3 RPM 100V50/60HZ <i>MOTOR SAIA UDS 3.3 RPM 100V50/60HZ</i>
	13		<b>1813.634</b>	HARNESS <i>HARNESS</i>
	13		<b>1813.649</b>	HARNESS <i>CABLAGGIO DISPENSER BICCHIERI</i>
	14		<b>U109.005</b>	SCREW AUT.TCB 3,5X16 DIN 7981C <i>VITE AUT.TCB 3,5X16 DIN 798</i>
	15		<b>9121.226.00A</b>	MOTOR SAIA UDS 5 RPM 220V <i>MOTORE SAIA UDS 5 RPM 220V</i>
	15		<b>9121.226.00F</b>	RATIOMOTOR SAIA UDS 5RPM 120V60HZ <i>RATIOMOTOR SAIA UDS 5RPM 120V 60HZ</i>
	15		<b>9121.226.00R</b>	MOTOR SAIA UDS 5 RPM 100V 50/60HZ <i>MOTOR SAIA UDS 5 RPM 100V 50/60HZ</i>
	16		<b>NE05.064</b>	MICROSWITCH SAIA V4NC <i>MICROINTERRUPTORE SAIA V4NC</i>
	17		<b>1813.A14.A2A</b>	CUP DISPENSER ASS. D.70 STD <i>ASS.CUP DISPENSER D.70 STD</i>
	17		<b>1813.A50.A2F</b>	ASS.CUP DISPENSER D.73 H.101 120V UL <i>ASS.CUP DISPENSER D.73 H.101 120V UL</i>

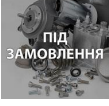
## Model Machine

MACSAE111

SAECO RUBINO 200 чорна (верхня частина)(10003260 )

	17		<b>1876.A01.A2A</b>	CUP DISPENSER ASS.D.73 H.101 <i>CUP DISPENSER ASS.D.73 H.101</i>
	17		<b>1884.A50.A2R</b>	ASS.CUP DISPENSER D73 H101 100V <i>ASS.CUP DISPENSER D73 H101 100V</i>
	18		<b>1813.064.A20</b>	ARM MOVEMENT CAM <i>ARM MOVEMENT CAM</i>
	19		<b>1813.068.A20</b>	TOOTHED WHEEL <i>TOOTHED WHEEL</i>
	20		<b>1813.062.A20</b>	LOWER CASING DISPENSER GLASSES <i>LOWER CASING DISPENSER GLASSES</i>
	20		<b>1813.308.050</b>	LOVER CASING DISPENSER GLASSESUL <i>LOVER CASING DISPENSER GLASSES UL</i>
	21		<b>U324.005</b>	NUT M3 FLANGED INDENTED BASE <i>DADO M3 FLANGIATO BASE DENTELLATA</i>
	22		<b>1813.207</b>	STICKER <i>STICKER</i>
	23		<b>144320200</b>	SELF LOCK STRIP W=2.6 L=200 <i>SELF LOCK STRIP W=2.6 L=200</i>
	24		<b>NV99.098</b>	WASHER D.5,2 X 13,2 SP.1,5 <i>WASHER D.5,2 X 13,2 SP.1,5</i>
	25		<b>1813.111</b>	SPRING FOR LEVER <i>MOLLA X LEVA BRACCIO UGELLI</i>
	26		<b>1813.184.050</b>	AGITATING LEVER <i>AGITATING LEVER</i>
	27		<b>U201.001</b>	PLAIN WASHER 3,2X9 DIN 7349 GALV. <i>PLAIN WASHER 3,2X9 DIN 7349 GALV.</i>

## Model Machine

MACSAE111

SAECO RUBINO 200 чорна (верхня частина)(10003260 )

	28		<b>NM02.016</b>	OR ORM 0100-20 TERMOIL <i>OR ORM 0100-20 TERMOIL</i>
	29		<b>1813.185</b>	PIN FOR LEVER GLASSES <i>PIN FOR LEVER GLASSES</i>
	30		<b>1813.063.A2A</b>	МЕХАНІЗМ ВИДАЧИ СТАКАНУ ВЗБОРІ <i>ASS.CORPO DISPENSER</i>
	30		<b>1813.A51.A2F</b>	DISPENSER ASS. D73 H95 120V UL <i>DISPENSER ASS. D73 H95 120V UL</i>
	30		<b>1884.A51.A2R</b>	DISPENSER ASS. D73 H95/101 100V <i>DISPENSER ASS. D73 H95/101 100V</i>
	31		<b>11000786</b>	RETAINING RING <i>RETAINING RING</i>
	31		<b>1813.070.A20</b>	BLOCK RING <i>BLOCK RING</i>
	32		<b>1813.072.A20</b>	SNAIL FOR GLASSES D.70 <i>CHIOCCIOLA X BICCHIERI</i>
	32		<b>1813.192.050</b>	SNAIL FOR GLASSES D.73 <i>CHIOCCIOLA X BICCHIERI D.73</i>
	33		<b>1813.073.A20</b>	TOOTHED WHEEL FOR SNAIL <i>TOOTHED WHEEL FOR SNAIL</i>
	34		<b>11000833</b>	SNAIL SUPPORT <i>SNAIL SUPPORT</i>
	34		<b>11000867</b>	SUPPORTO CHIOCCIOLE UL FASATO <i>SUPPORTO CHIOCCIOLE UL FASATO</i>
	34		<b>1813.071.A20</b>	SUPPORT SNAIL <i>SUPPORT SNAIL</i>
	34		<b>1813.306.050</b>	SUPPORT SNAIL UL <i>SUPPORT SNAIL UL</i>



## Model Machine

MACSAE111

SAECO RUBINO 200 чорна (верхня частина)(10003260 )

	35		1813.074.A20	TOOTHED WHEEL TOOTHED WHEEL
	36		11000835	ASS.SNAIL SUPPORT ASS.SNAIL SUPPORT
	36		11000863	ASSEMBLY SUPPORT ASSEMBLY SUPPORT
	36		11000866	ASSEMBLY SUPPORT ASSEMBLY SUPPORT
	36		1813.069.A20	SUPPORT ASS. SUPPORT ASS.
	36		1813.A16.A20	SUPPORT ASS. SUPPORT ASS.
	36		1813.A52.A20	SUPPORT ASS. SUPPORT ASS.
	37		1813.118.050	LEVER ASS. GLASSES ASS.LEVA BICCHIERE
	37		1813.216.050	LEVER GLASS H.101 LEVA BICCHIERE H.101
	38		1813.119.050	LEVER GLASS LEVA BICCHIERE
	39		U207.001	PLAIN WASHER 5,3X10 UNI 6592 GAL ROSETTA PIANA 5,3X10 UNI 6
	40		U310.003	NUT SELF LOCK.M5 UNI 7473 NUT SELF LOCK.M5 UNI 7473
	41		1813.120.050	SPACE FOR LEVER GLASS UNGHIA X LEVA BICCHIERE
	42		U212.006	WASHER 3,2X11X0,5 ZNP WASHER 3,2X11X0,5 ZNP

## Model Machine

MACSAE111

SAECO RUBINO 200 чорна (верхня частина)(10003260 )



43

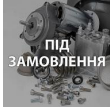

U043.020

SCREW TCBC M3,0X6 UNI 7687 GALV.

VITE TCBC M3,0X6 UNI 7687 Z

# Model Machine

MACSAE111

SAECO RUBINO 200 чорна (верхня частина)(10003260 )



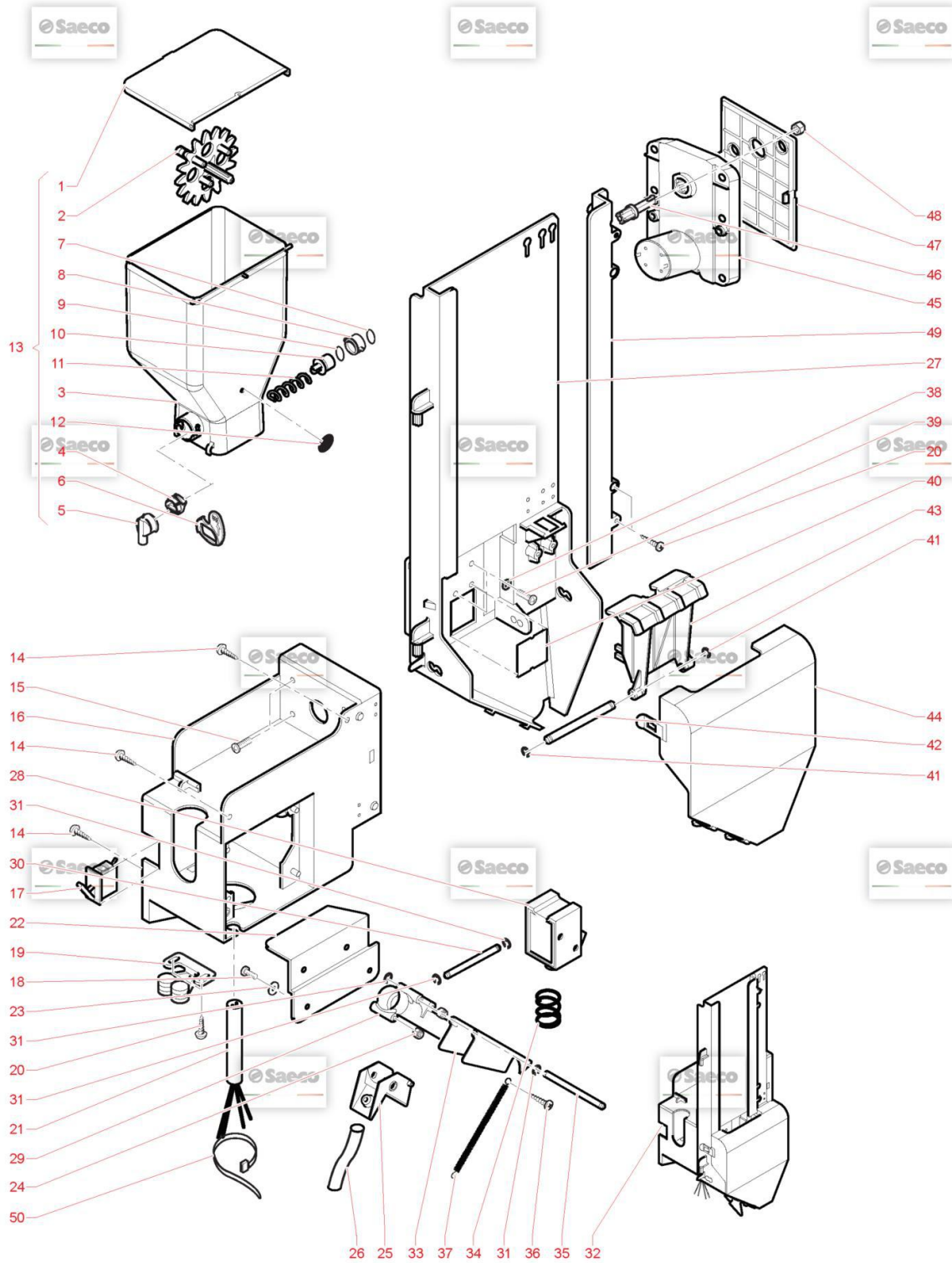























MACSAE111.T.0010



## Model Machine

MACSAE111

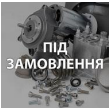















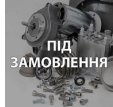

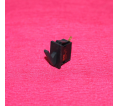





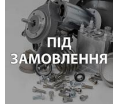

SAECO RUBINO 200 чорна (верхня частина)(10003260 )

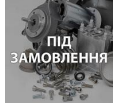
Web	Pos.	Foto	Item - Replace by	Description
				<i>Press - CTRL + CLICK go to item in a new window Натисніть - Ctrl + права кнопка миші щоб відкрити запчастину в новому вікні</i>
	1		1813.098	SUGAR CONTAINER LID SUGAR CONTAINER LID
	2		11007683	CONTAINER WHEEL SUGAR RUBINO200 RUOTA CONTENITORE ZUCCHERO
	3		1813.058	SUGAR CONTAINER CONTENITORE ZUCCHERO
	4		9111.630.060	BUSH FOR POWDERS TANK BOCCOLA X SERBAT.POLVERI C/AGGANCI
	5		9111.629.060	APERTURE FOR SOLUBLES HOPPER APERTURE FOR SOLUBLES HOPPER
	6		9111.338.270	BULKHEAD FOR APERT. CLOSURE ORANGE PARATIA CHIUSURA BOCCHETTA ARANCIO
	7		140328461	ПРОКЛАДКА O-RING 0190-10 ДЛЯ КОФЕМАШИНЫ PHILIPS SAECO 99653... OR METRICO 0190-10 IN EPDM NUOVO PREZZO 0,13
	8		11005456	REAR BUSH NEW REAR BUSH NEW
	9		NM03.013	OR 2,3X15 NBR OR 2,3X15 NBR
	10		9111.017.060	COUPLING FOR SPRING BROWN GIUNTO X MOLLA MARRON
	11		9111.634	SPRING MOLLA X POLVERI
	12		9111.646	ADHESIVE FOR TANK ADHESIVE FOR TANK
	13		9110.101	SUGAR CONT. ASS. SG 200 ASS.CONTENITORE ZUCCHERO SG

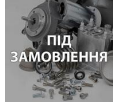
## Model Machine

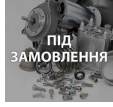
MACSAE111

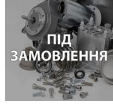





















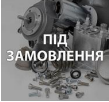

SAECO RUBINO 200 чорна (верхня частина)(10003260 )

	14		<b>U116.002</b>	SCREW AUT.PT TCB 3,5X16 WN 1441 <i>SCREW AUT.PT TCB 3,5X16 WN 1441</i>
	15		<b>129825502</b>	TCB SCREW M4X25 UNI 7687 ZNP <i>TCB SCREW M4X25 UNI 7687 ZNP</i>
	16		<b>1813.055.A20</b>	SUGAR SHELF <i>MENSOLA ZUCCHERO</i>
	16		<b>1813.301.050</b>	SUGAR SHELF UL <i>SUGAR SHELF UL</i>
	17		<b>NE05.063</b>	MICROSWITCH + LEVER <i>MICROINTERRUTTORE C/LEVA</i>
	18		<b>U043.036</b>	SCREW TCBC M3,0X35 UNI 7687 GALV. <i>SCREW TCBC M3,0X35 UNI 7687 GALV.</i>
	19		<b>12000731</b>	LATCH 2 ROLLERS MOD. 244.01.903 <i>CRICCHETTO A DUE RULLI MOD. 244.01.903</i>
	19		<b>NF11.036</b>	LATCH 2 ROLLERS <i>CRICCHETTO A DUE RULLI</i>
	20		<b>U116.005</b>	SCREW AUT.PT TCB 3,0X8 WN 1441 <i>VITE AUT.PT TCB 3,0X8 WN 1441 ZNP</i>
	21		<b>11000641</b>	HARNESS <i>HARNESS</i>
	21		<b>1813.636</b>	HARNESS <i>HARNESS</i>
	21		<b>1813.650</b>	HARNESS <i>HARNESS</i>
	22		<b>1813.090.A20</b>	SUGAR DUCT SUPPORT <i>SUGAR DUCT SUPPORT</i>
	23		<b>U201.001</b>	PLAIN WASHER 3,2X9 DIN 7349 GALV. <i>PLAIN WASHER 3,2X9 DIN 7349 GALV.</i>

## Model Machine

MACSAE111



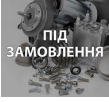







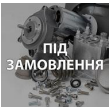

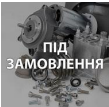













SAECO RUBINO 200 чорна (верхня частина)(10003260 )

	24		<b>U324.005</b>	NUT M3 FLANGED INDENTED BASE <i>DADO M3 FLANGIATO BASE DENTELLATA</i>
	25		<b>1813.053.050</b>	SUGAR SLIDE <i>SCIVOLO ZUCCHERO</i>
	26	 ПІД ЗАМОВЛЕННЯ	<b>9974.030</b>	PVC TUBE 16X20 L.120 MM <i>TUBO PVC 16X20 L.115 MM</i>
	27		<b>1813.054.A20</b>	BASE STIRRER DISPENSER <i>PALETTIERIA BASE</i>
	28	 LIBERTY	<b>9121.217.00A</b>	ELECTROMAGNET "RELE" ED 07% 230V <i>ELETTROMAGNETE "RELE" ED 07% 230V</i>
	28	 ПІД ЗАМОВЛЕННЯ	<b>9121.217.00F</b>	ELECTROMAGNET "RELE" ED 07% 120V 60HZ <i>ELECTROMAGNET "RELE" ED 07% 120V 60HZ</i>
	28	 ПІД ЗАМОВЛЕННЯ	<b>9121.217.00N</b>	ELECTROMAGNET "RELE" ED 07% 220V 60HZ <i>ELECTROMAGNET "RELE" ED 07% 220V 60HZ</i>
	28	 ПІД ЗАМОВЛЕННЯ	<b>9121.217.00R</b>	ELECTROMAGNET "RELE" ED 07% 100V 50/60HZ <i>ELECTROMAGNET "RELE" ED 07% 100V 50/60HZ</i>
	29		<b>0871.212.050</b>	SUGAR DUCT <i>CONDOTTO ZUCCHERO</i>
	30		<b>9111.327</b>	SUGAR DOOR ROTATION PIN <i>PERNO ROTAZIONE PORTELLO ZUC</i>
	31		<b>U701.012</b>	SNAP RING 1,5 UNI 7434 <i>ANELLO ELASTICO 1,5 U</i>
	32	 Liberty	<b>1813.A05.00A</b>	STIRRER DISPENSER ASS. SUGAR <i>ASS.PALETTIERA ZUCCHERO</i>
	32	 ПІД ЗАМОВЛЕННЯ	<b>1813.A05.00F</b>	STIRRER DISPENSER ASS. SUGAR 120V <i>STIRRER DISPENSER ASS. SUGAR 120V</i>

## Model Machine

MACSAE111











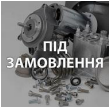

SAECO RUBINO 200 чорна (верхня частина)(10003260 )

	32		<b>1813.A05.00N</b>	STIRRER DISPENSER ASS. SUGAR <i>STIRRER DISPENSER ASS. SUGAR</i>
	32		<b>1884.A08.00R</b>	STIRRER DISPENSER ASS. SUGAR 100V <i>STIRRER DISPENSER ASS. SUGAR 100V</i>
	33		<b>1813.122.050</b>	SUGAR SLIDE LID <i>COPERCHIO SCIVOLO ZUCCHERO</i>
	34		<b>11002210</b>	SPRING FOR ELECTROMAGNET <i>SPRING FOR ELECTROMAGNET</i>
	35		<b>1813.087</b>	LID PIN SUGAR <i>PERNO COPERCHIO ZUCCHERO</i>
	36		<b>U109.006</b>	SCREW AUT.TCB 2,2X9,5 DIN 7981C <i>VITE AUT.TCB 2,2X9,5 DIN 7981 C NIK</i>
	37		<b>9161.005</b>	SPRING FOR DISPENSER DOOR <i>SPRING FOR DISPENSER DOOR</i>
	38		<b>128310404</b>	МЕТАЛЕВЕ УБЧАСТЕ КОЛИЩАТКО UNI 8842 A4 <i>WASHER UNI 8842 A4 BURNISHED</i>
	39		<b>U043.012</b>	SCREW TCB TORX 20 M4X6 ZN-B <i>VITE TCBC M4,0X6 UNI 7687 Z</i>
	40		<b>1813.050.A20</b>	ELECTROMAGNET COVER <i>ELECTROMAGNET COVER</i>
	41		<b>U701.006</b>	SNAP RING 3,2 UNI 7434 <i>ANELLO ELASTICO 3,2</i>
	42		<b>9111.376</b>	PIN FOR STIRRER EXPELLER <i>PIN FOR STIRRER EXPELLER</i>
	43		<b>11011240</b>	STIRRER EXPELLER BLACK NEW <i>STIRRER EXPELLER BLACK NEW</i>
	44		<b>1813.052.A20</b>	SLIDE COVER STIRRER DISPENSER <i>COPERTURA SCIVOLO PALETTIERA</i>

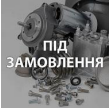
## Model Machine

MACSAE111

SAECO RUBINO 200 чорна (верхня частина)(10003260 )

	45		<b>9121.202.00P</b>	RATIOMOTOR 60 RPM 24V <i>MOTORIDUTTORE KENTA 60 RPM 2</i>
	45		<b>9121.247.00P</b>	RATIOMOTOR 60 RPM 24V UL <i>RATIOMOTOR 60 RPM 24V UL</i>
	46		<b>9111.586.050</b>	PIN FOR MOTORS KENTA <i>PERNO X MOTORI KENTA</i>
	47		<b>1813.051.A20</b>	MOTOR COVER SUGAR <i>MOTOR COVER SUGAR</i>
	48		<b>123453102</b>	GALV.SELF LOCK NUT HIGH M4 DIN982 <i>GALV.SELF LOCK NUT HIGH M4 DIN 982</i>
	49		<b>1813.056.A20</b>	STIRRER ADJUSTMENT <i>STIRRER ADJUSTMENT</i>
	50		<b>NF11.002</b>	SELF LOCK STRIP W=2.5 L=98 <i>SELF LOCK STRIP W=2.5 L=98</i>



# Model Machine

MACSAE111

SAECO RUBINO 200 чорна (верхня частина)(10003260 )

MACSAE111.T.0011

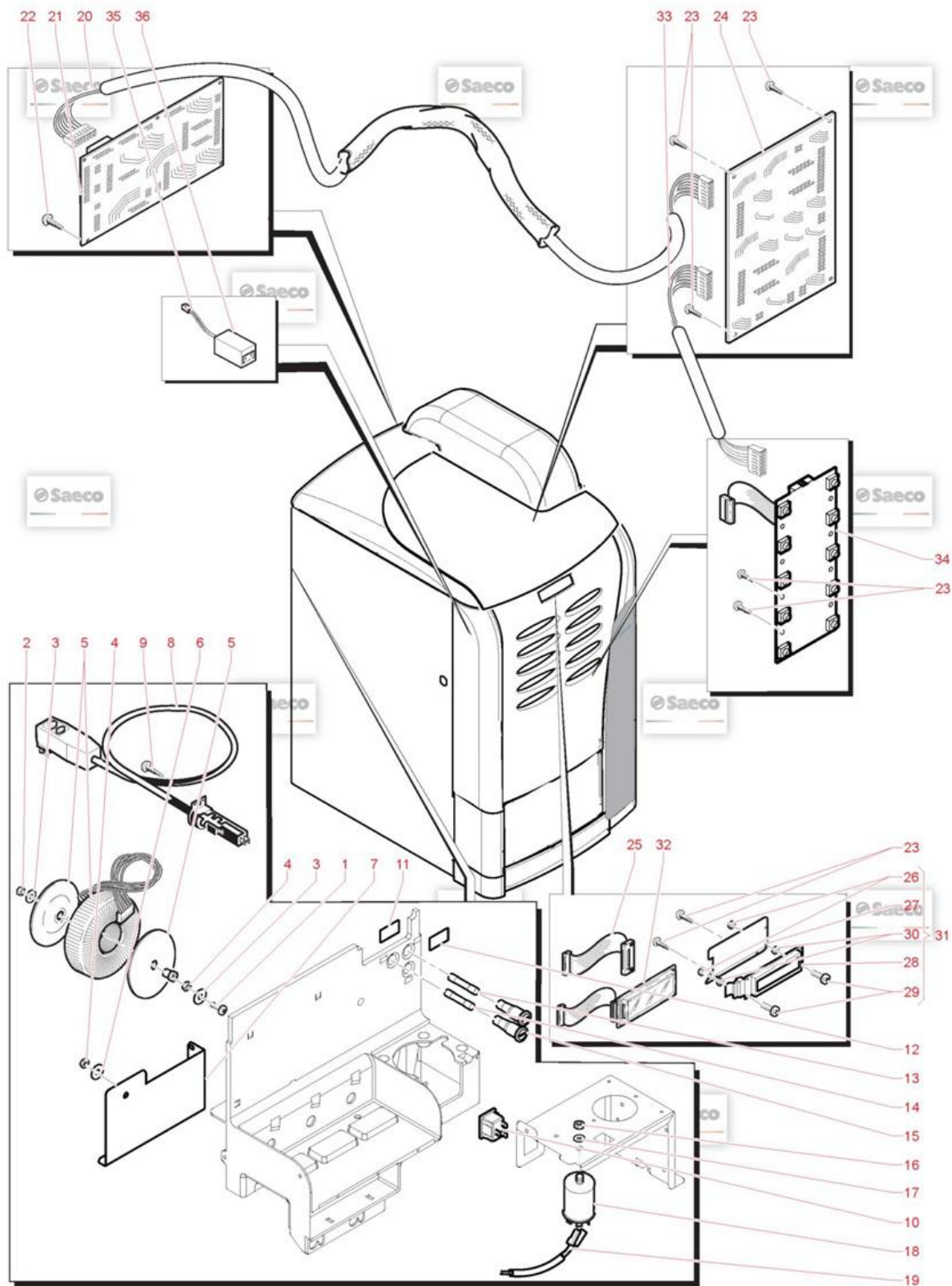

## Model Machine

MACSAE111

SAECO RUBINO 200 чорна (верхня частина)(10003260 )

Web Pos. Foto Item - Replace by Description



Press - CTRL + CLICK go to item in a new window

Натисніть - Ctrl + права кнопка миші щоб відкрити запчастину в новому вікні



1

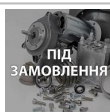

12000012

SCREW TE M6,0X50 UNI 5739 ZNP  
SCREW TE M6,0X50 UNI 5739 ZNP



2



U310.004

NUT SELF LOCK.M6 UNI 7473  
NUT SELF LOCK.M6 UNI 7473



3

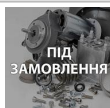

U207.013

PLAIN WASHER 6.5X18 UNI 6592 GALV  
PLAIN WASHER 6.5X18 UNI 6592 GALV



4



U302.004

NUT HEXAGONAL M6 UNI 5588  
DADO ESAGONALE M6 UNI 5



5

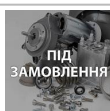

NE19.014

TOROIDAL TRANSFORMER 8P UL  
TOROIDAL TRANSFORMER 8P UL



5

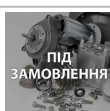

NE19.015

TOROIDAL TRANSFORMER 8P 100V  
TOROIDAL TRANSFORMER 8P 100V



5



NE19.025

TOROIDAL TRANSFORMER SG200  
TOROIDAL TRANSFORMER SG200



6



U208.006

TOOTHED WASHER 6,4X11 UNI 3703  
ROSETTA DENT. 6,4X11 UNI 3



7

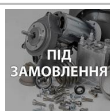

11000044

PLATE  
PLATE



8

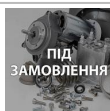

11012009

POWER CABLE USA 3 POLE 15A X GFC8  
POWER CABLE USA 3 POLE 15A X GFC8



9



U110.005

SCREW AUT.TCB 3,9X9,5 DIN 7981F  
VITE AUT.TCB 3,9X9,5 DIN 798



10



187850400

TRIPOLE SOCKET SELF-LOCKING  
TRIPOLE SOCKET SELF-LOCKING



10















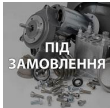

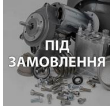

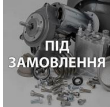







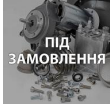

NE13.013

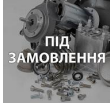
CUP SOCKET EN 60320 C 13  
CUP SOCKET EN 60320 C 13

## Model Machine

MACSAE111

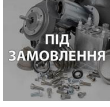















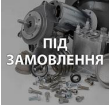





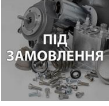

SAECO RUBINO 200 чорна (верхня частина)(10003260 )

	11		<b>0894.176</b>	DATA PLATE FUSE F 8 A <i>DATA PLATE FUSE F 8 A</i>
	11		<b>1813.224</b>	DATA PLATE FUSE T 15 A <i>DATA PLATE FUSE T 15 A</i>
	12		<b>1813.220</b>	DATA PLATE FUSE T 4A <i>DATA PLATE FUSE T 4A</i>
	12		<b>1813.312</b>	DATA PLATE FUSE T 3A <i>DATA PLATE FUSE T 3A</i>
	13		<b>NE13.081</b>	FUSE 6,3X32 16A 250V DELAYED UL <i>FUSIBILE 6,3 X 32 15A 250V RITARD UL SOLO UL</i>
	13		<b>NE13.082</b>	FUSE F 8A 6.3X32 <i>FUSIBILE F 8A 6.3X32A65</i>
	14		<b>NE13.091</b>	FUSE T 4A 6.3X32 <i>FUSIBILE T 4A 6.3X32 RITARDATO</i>
	14		<b>NE13.101</b>	FUSE 6,3X32 3A 250V DELAYED UL <i>FUSE 6,3X32 3A 250V DELAYED UL</i>
	15		<b>NE13.016</b>	FUSE HOLDER WITH SCREW ON CAP <i>PORTAFUSIBILE CON TAPPO A VITE</i>
	16		<b>U302.007</b>	NUT HEXAGONAL M8 UNI 5588 <i>NUT HEXAGONAL M8 UNI 5588</i>
	17		<b>U208.009</b>	TOOTHED WASHER 8,4X15 UNI 3703 <i>TOOTHED WASHER 8,4X15 UNI 3703</i>
	18		<b>12001353</b>	МЕРЕЖЕВИЙ ФІЛЬТР 16A <i>LOCKING SCREW ANTIDISTURB FILTER 16A</i>
	18		<b>184651500</b>	LOCKING SCREW ANTIDISTURB FILTER 16A <i>LOCKING SCREW ANTIDISTURB FILTER 16A</i>
	19		<b>1813.641</b>	HARNESS <i>HARNESS</i>

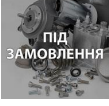
## Model Machine

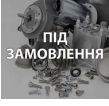
MACSAE111

SAECO RUBINO 200 чорна (верхня частина)(10003260 )

	19		1813.655	HARNESS HARNESS
	20		1813.605	CPU/POWER HARNESS CPU/POWER HARNESS
	21		1813.613	POWER CARD SG 200 SCHEDA DI POTENZA SG 200
	21		1813.632	POWER CARD UL SG 200 POWER CARD UL SG 200
	22		U110.011	SCREW AUT.TCB 2,9X9,5 DIN 7981F SCREW AUT.TCB 2,9X9,5 DIN 7981 F
	23		U116.006	SCREW AUT.PT TCB 3,5X12 WN 1441 ZNP VITE AUT.PT TCB 3,5X12 WN 1441 ZNP
	24		11008089	CPU+SW AS.SG200DUALTECH CPU+SW AS.SG200DUALTECH
	24		11013319	CPU+SW AS.SG200 HS1 CPU+SW AS.SG200 HS1
	24		1813.627	CPU CARD SG 200 CPU CARD SG 200
	25		11021701	FLAT CABLE 16 POLES L.150MM FLAT CABLE 16 POLES L.150MM
	25		1813.601	FLAT CABLE 16 POLE DISPLAY FLAT CABLE 16 POLE DISPLAY
	26		U310.001	GALV.SELF LOCK. NUT M3 UNI 7473 DADO AUTOBLOC M3 UNI 7473 ZNP
	27		1813.085	DISPLAY SUPPORT DISPLAY SUPPORT

## Model Machine

MACSAE111

SAECO RUBINO 200 чорна (верхня частина)(10003260 )

	28		0862.603	DISPLAY <i>DISPLAY</i>
	29		U043.017	SCREW TCB TORX 10 M3X12 ZN-B <i>SCREW TCB TORX 10 M3X12 ZN-B</i>
	30		NF11.047	NUT M4 H.4,5 IN PLASTIC <i>NUT IN PLASTIC</i>
	31		11021792	DISPLAY ASS. BLUE <i>DISPLAY ASS. BLUE</i>
	31		1813.A21	DISPLAY ASS. <i>DISPLAY ASS.</i>
	32		192200500	20X2 LCD BLUE DISPLAY STN + FLAT <i>20X2 LCD BLUE DISPLAY STN + FLAT</i>
	33		1813.615	FLAT CABLE 14 POLE KEYBOARD <i>FLAT CABLE 14 POLE KEYBOARD</i>
	34		1813.610	TOUCH PANEL SG 200 <i>TOUCH PANEL SG 200</i>
	35		1813.639	HARNESS <i>HARNESS</i>
	35		1813.654	HARNESS <i>HARNESS</i>
	36		NE13.025.00P	IMPULSE COUNTER KEISU GX-06R 24V <i>CONTAIMPULSI KEISU GX-06R 24</i>

# Model Machine

MACSAE111

SAECO RUBINO 200 чорна (верхня частина)(10003260 )

MACSAE111.T.0012



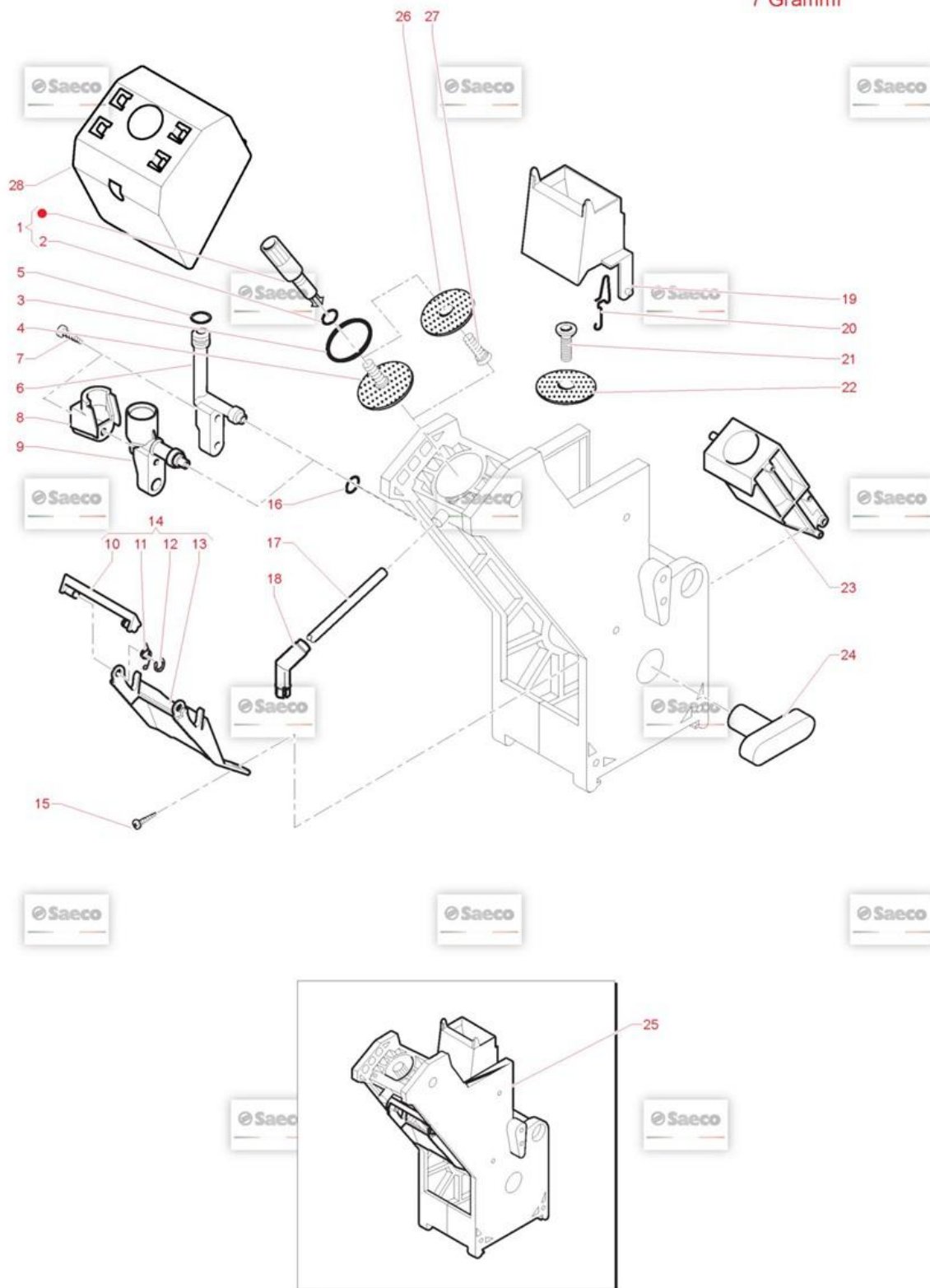



















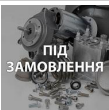



7 Grammi



## Model Machine

MACSAE111

























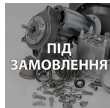

SAECO RUBINO 200 чорна (верхня частина)(10003260 )

Web	Pos.	Foto	Item - Replace by	Description
				<i>Press - CTRL + CLICK go to item in a new window Натисніть - Ctrl + права кнопка миші щоб відкрити запчастину в новому вікні</i>
	1		9169.A14.060	ТРИМАЧ ФІЛЬТРА-СИТО РОБОЧОГО БЛОКУ КОРИЧНЕВИЙ КАВОМАШИН... <i>PIN FOR PERCOLATOR BROWN</i>
	2		NM02.006	OR R5 TERMOIL <i>OR R5 EPDM</i>
	3		140322061	O-RING 4112 EPDM <i>OR 4112 IN EPDM</i>
	4		324000100	SS PERCOLATOR D=34 SCREW FOR UNIT <i>SS PERCOLATOR D=34 SCREW FOR UNIT</i>
	5		140320461	OR ORM 0080-20 TERMOIL <i>OR ORM 0080-20 IN TERMOIL</i>
	6		322000501	WATERFLOW PISTON BROWN <i>WATERFLOW PISTON BROWN</i>
	7		129512921	SCREW TCB TORX 10 AB 2,9X13 SHEET SS <i>SCREW TCB TORX 10 2,9X13 SHEET SS</i>
	8		11010013	CARTER FOR MUFF PREHEATING UNIT <i>CARTE X MANICOTTO GRUPPO PRERISCALDO</i>
	9		11005371	UNIT COFFEE MUFF <i>MANICOTTO GRUPPO CAFFE' UNIT COFFEE MUFF</i>
	10		9111.537.060	BROWN SCRAPER COFFEE GROUP <i>BROWN SCRAPER COFFEE GROUP</i>
	11		9111.520	SPRING FOR SCRAPER SECTION 0.6 <i>SPRING FOR SCRAPER SECTION 0.6</i>
	12		U701.006	SNAP RING 3,2 UNI 7434 <i>ANELLO ELASTICO 3,2</i>
	13		9111.539.060	FORK FOR SCRAPER <i>FORCELLA PER RASCHIATORE</i>

## Model Machine

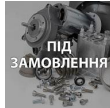
MACSAE111

SAECO RUBINO 200 чорна (верхня частина)(10003260 )

	14		9110.067.060	SCRAPER ASS.FOR CAPPUCINAT. TUBE ASS.RASCHIATORE X SG500/700
	15		U110.013	SCREW AUT.TCB 3,9X6,5 DIN 7981F SCREW AUT.TCB 3,9X6,5 DIN 7981 F
	16		140321462	O-RING 2018 SILICONE OR 2018 IN SILICONE
	17		9972.057	КОРИЧНЕВА ГУМОВА ТРУБКА 5X8 2 МЕТРИ TUBO SILICONE MARRON 5X8 L.2000 MM
	18		9111.349	ELBOW DISPENSING NOZZLE UGELLO EROGAZIONE GOMITO
	19		322001201	MOBILE SCRAPER BROWN NARROW MOBILE SCRAPER BROWN NARROW
	20		9161.425	SPRING FOR SCRAPER SPRING FOR SCRAPER
	21		129851921	TSP SCREW M3X6 UNI 7688 SS TSP SCREW M3X6 UNI 7688 SS
	22		324000200	SS PERCOLATOR D=34 FOR UNIT SS PERCOLATOR D=34 FOR UNIT
	23		222711101	BROWN GROUND COFF.CONTAINER D=36 ASSY. BROWN GROUND COFF.CONTAINER D=36 ASSY.
	24		9161.021.060	KEY FOR BREW UNIT BROWN CHIAVE X GRUPPO CAFFE' MARRO
	25		11005421	BREW UNIT 7 GRAMS CRISTALLO600 GRUPPO CAFFE' 7GR CRISTALLO600
	25		11023330	BREW UNIT 7 GRAMS BREW UNIT 7 GRAMS CRISTALLO600
	25		9160.078.060	BROWN BREW UNIT DA 10P 7 GRAMS GRUPPO CAFFE' C/RASCHIATORE



## Model Machine

MACSAE111

SAECO RUBINO 200 чорна (верхня частина)(10003260 )



26



11012630

PERCOLATOR D.34  
*PERCOLATOR D.34*



27



129852821

TSP SCREW M3X14 UNI 7688 SS  
*TSP SCREW M3X14 UNI 7688 SS*



28



11013053

CARTER FOR DOSER UNIT  
*CARTER FOR DOSER UNIT*

# Model Machine

MACSAE111

SAECO RUBINO 200 чорна (верхня частина)(10003260 )

MACSAE111.T.0013



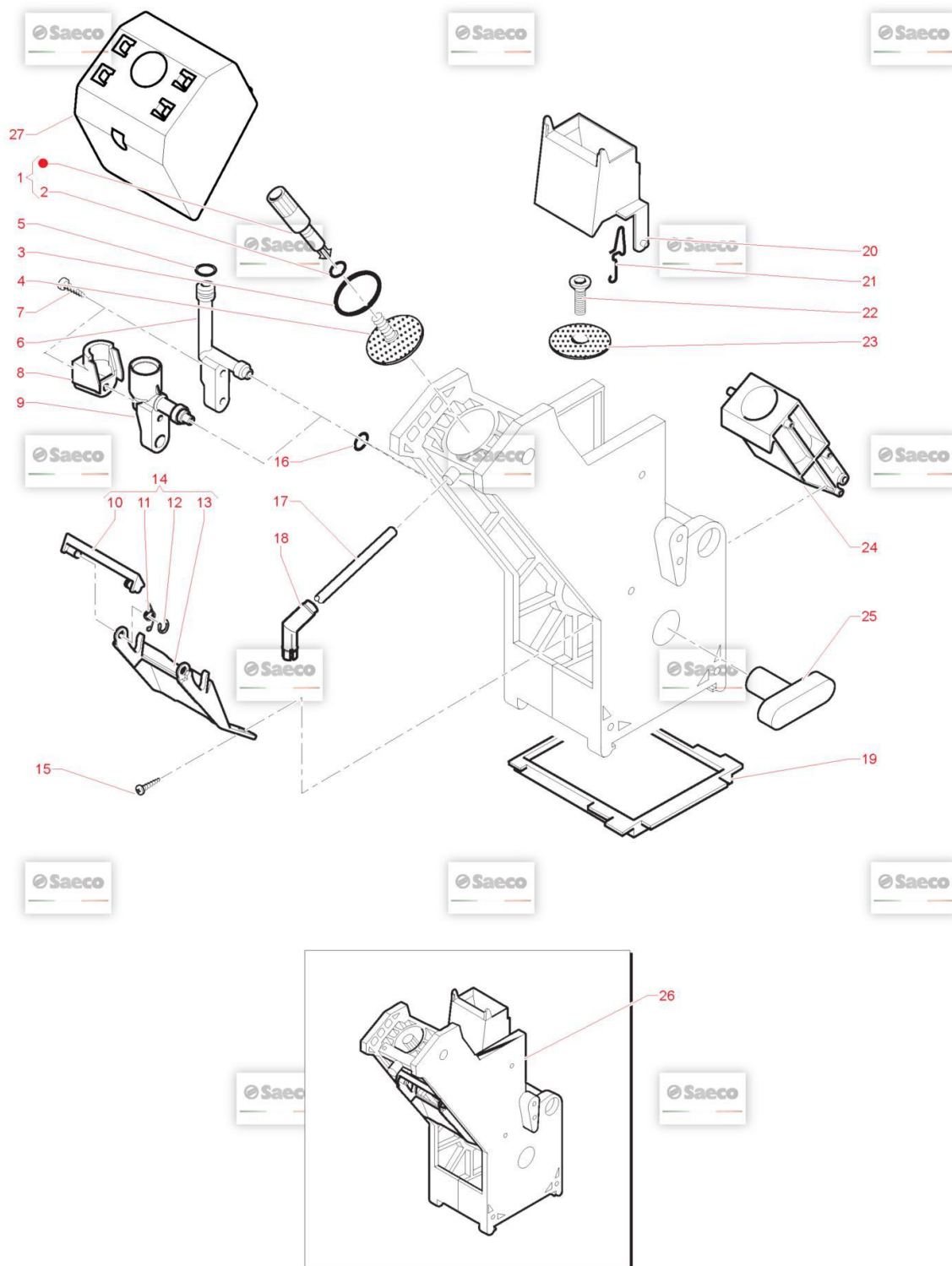























9 Grammi



## Model Machine

MACSAE111





























SAECO RUBINO 200 чорна (верхня частина)(10003260 )

Web	Pos.	Foto	Item - Replace by	Description
				<i>Press - CTRL + CLICK go to item in a new window Натисніть - Ctrl + права кнопка миші щоб відкрити запчастину в новому вікні</i>
	1		9169.A14.150	PIN FOR PERCOLATOR GREY ASS.PERNO X DOCCIA COMPLETO GRIGIO
	2		NM02.006	OR R5 TERMOIL OR R5 EPDM
	3		NM01.044	OR ORM 0320-40 SILICONE PTFE/FDA OR ORM 0320-40 SILICONE PTFE
	4		9161.036	UPPER PERCOLATOR FOR UNIT DOCCIA SUPERIORE X GRUPPO
	5		140320461	OR ORM 0080-20 TERMOIL OR ORM 0080-20 IN TERMOIL
	6		322000559	WATER FLOW PISTON GREY WATER FLOW PISTON GREY
	7		129512921	SCREW TCB TORX 10 AB 2,9X13 SHEET SS SCREW TCB TORX 10 2,9X13 SHEET SS
	8		11010013	CARTER FOR MUFF PREHEATING UNIT CARTE X MANICOTTO GRUPPO PRERISCALDO
	9		11005371	UNIT COFFEE MUFF MANICOTTO GRUPPO CAFFE' UNIT COFFEE MUFF
	10		9111.537.150	GREY SCRAPER COFFEE GROUP GREY SCRAPER COFFEE GROUP
	11		9111.520	SPRING FOR SCRAPER SECTION 0.6 SPRING FOR SCRAPER SECTION 0.6
	12		U701.006	SNAP RING 3,2 UNI 7434 ANELLO ELASTICO 3,2
	13		9111.539.150	FORK FOR SCRAPER FORCELLA PER RASCHIATORE

## Model Machine

MACSAE111

SAECO RUBINO 200 чорна (верхня частина)(10003260 )

	14		9110.067.150	SCRAPER ASS.FOR CAPPUCCINAT. TUBE ASS.RASCHIATORE X SG500/700
	15		U110.013	SCREW AUT.TCB 3,9X6,5 DIN 7981F SCREW AUT.TCB 3,9X6,5 DIN 7981 F
	16		140321462	O-RING 2018 SILICONE OR 2018 IN SILICONE
	17		9972.057	КОРИЧНЕВА ГУМОВА ТРУБКА 5X8 2 МЕТРИ TUBO SILICONE MARRON 5X8 L.2000 MM
	18		9111.349	ELBOW DISPENSING NOZZLE UGELLO EROGAZIONE GOMITO
	19		9161.020.060	PLATE FOR COFFEE UNIT BROWN PLATE FOR COFFEE UNIT BROWN
	20		322001259	ПЛАСТИКОВА ВОРНОКА ПОДАЧІ КАВИ (ПЛАСТИК) ЧОРНИЙ MOBILE SCRAPER GREY NARROW
	21		9161.425	SPRING FOR SCRAPER SPRING FOR SCRAPER
	22		129851921	TSP SCREW M3X6 UNI 7688 SS TSP SCREW M3X6 UNI 7688 SS
	23		9161.037	LOWER PERCOLATOR FOR UNIT DOCCIA INFERIORE X GRUPPO
	24		11002626	ASS. COFFEE CONTAINER GREY 9 GR. ASS. COFFEE CONTAINER GREY 9 GR.
	25		9161.021.060	KEY FOR BREW UNIT BROWN CHIAVE X GRUPPO CAFFE' MARRO
	26		11005422	BREW UNIT 9 GRAMS GRUPPO CAFFE' 9GR CRISTALLO 600
	26		9160.079.150	BREW UNIT 9 GRAMS GRUPPO CAFFE' C/RASCHIATORE 9

## Model Machine

MACSAE111

SAECO RUBINO 200 чорна (верхня частина)(10003260 )



27



11013053

CARTER FOR DOSER UNIT

*CARTER FOR DOSER UNIT*

# Model Machine

MACSAE111

SAECO RUBINO 200 чорна (верхня частина)(10003260 )

MACSAE111.T.0014

T.T.T. 10 Grammi

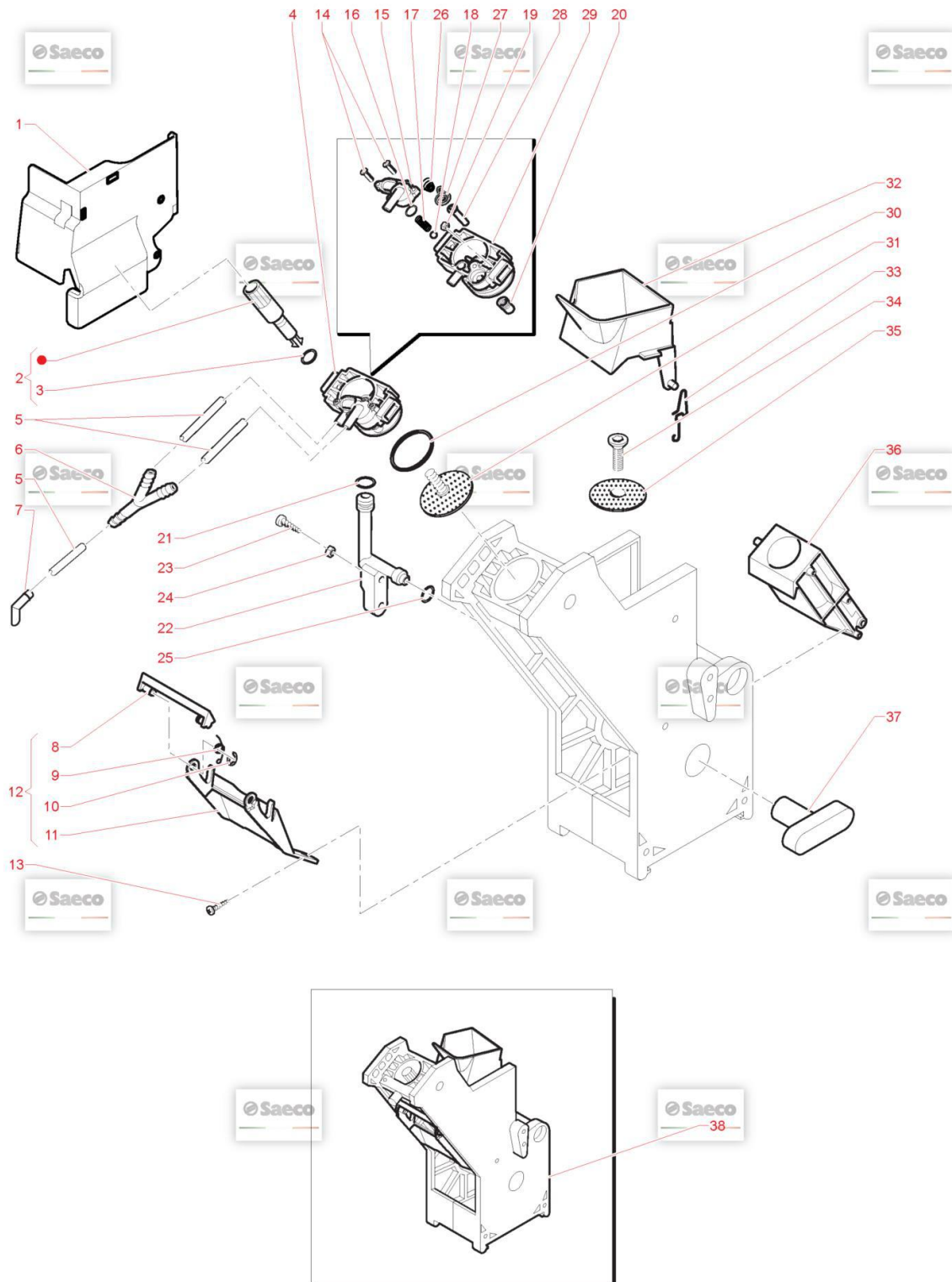

## Model Machine

MACSAE111

SAECO RUBINO 200 чорна (верхня частина)(10003260 )

Web Pos. Foto Item - Replace by Description



Press - CTRL + CLICK go to item in a new window

Натисніть - Ctrl + права кнопка миші щоб відкрити запчастину в новому вікні



1

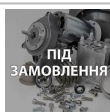

11003530

CARTER FOR DOSER UNIT FRESH BREW  
CARTER FOR DOSER UNIT FRESH BREW



2



9169.A14.150

PIN FOR PERCOLATOR GREY  
ASS.PERNO X DOCCIA COMPLETO GRIGIO



3



NM02.006

OR R5 TERMOIL  
OR R5 EPDM



4



11007343

ASS.COUNTERPISTON FRESH-BREW  
ASS.COUNTERPISTON FRESH-BREW



5



9972.057

КОРИЧНЕВА ГУМОВА ТРУБКА 5X8 2 МЕТРИ  
TUBO SILICONE MARRON 5X8 L.2000 MM



6



147920800

Y CONNECTOR D=8 ART.80.26.048KA.466  
RACCORDO Y D=8 ART.80.26.048 KA.466



7



1813.109.050

NOZZLES  
NOZZLES



8



9111.537.150

GREY SCRAPER COFFEE GROUP  
GREY SCRAPER COFFEE GROUP



9



9111.520

SPRING FOR SCRAPER SECTION 0.6  
SPRING FOR SCRAPER SECTION 0.6



10



U701.006

SNAP RING 3,2 UNI 7434  
ANELLO ELASTICO 3,2



11



9111.539.150

FORK FOR SCRAPER  
FORCELLA PER RASCHIATORE



12



9110.067.150

SCRAPER ASS.FOR CAPPUCCINAT. TUBE  
ASS.RASCHIATORE X SG500/700



13













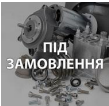















U110.013

SCREW AUT.TCB 3,9X6,5 DIN 7981F  
SCREW AUT.TCB 3,9X6,5 DIN 7981 F

## Model Machine

MACSAE111

SAECO RUBINO 200 чорна (верхня частина)(10003260 )













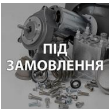



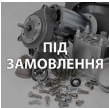



	14		<b>U109.030</b>	CAMOPІЗ AUT.TCB 2,9X16 DIN 7981 C SCREW AUT.TCB 2,9X16 DIN 7981 C
	15		<b>11003470</b>	КРИШКА НОСИКА LID X COUNTERPISTON FRESH-BREW
	16		<b>NM02.013</b>	OR ORM 0080-15 TERMOIL OR ORM 0080-15 TERMOIL
	17		<b>11007470</b>	SPRING FOR FS400 COVER CHASSIS SPRING FOR FS400 COVER CHASSIS
	18		<b>12001650</b>	SPHERE TEFLON D.5 SPHERE TEFLON D.5
	19		<b>U302.003</b>	GALV.NUT HEXAGONAL M4 UNI 5589ZN DADO ESAGONALE M4 UNI 5588 ZNP
	20		<b>11003472</b>	RUBBER X UNIT FRESH-BREW RUBBER X UNIT FRESH-BREW
	21		<b>140320461</b>	OR ORM 0080-20 TERMOIL OR ORM 0080-20 IN TERMOIL
	22		<b>322000559</b>	WATER FLOW PISTON GREY WATER FLOW PISTON GREY
	23		<b>129852821</b>	TSP SCREW M3X14 UNI 7688 SS TSP SCREW M3X14 UNI 7688 SS
	24		<b>U301.003</b>	ГАЙКА HEXAGONAL M3 UNI 5587 NUT HEXAGONAL M3 UNI 5587
	25		<b>140321462</b>	O-RING 2018 SILICONE OR 2018 IN SILICONE
	26		<b>11002603</b>	SPING FOR MEMBRANE SPING FOR MEMBRANE
	27		<b>11002625</b>	MEMBRANE MEMBRANE



## Model Machine

MACSAE111

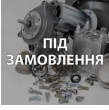
SAECO RUBINO 200 чорна (верхня частина)(10003260 )

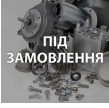
	28		11003471	PIN FOR MEMBRANE FRESH-BREW <i>PIN FOR MEMBRANE FRESH-BREW</i>
	29		11003469	COUNTERPISTON FRESH-BREW <i>COUNTERPISTON FRESH-BREW</i>
	30		NM01.044	OR ORM 0320-40 SILICONE PTFE/FDA <i>OR ORM 0320-40 SILICONE PTFE</i>
	31		11008362	PERCOLATOR ASS. FOR UNIT TTT <i>PERCOLATOR ASS. FOR UNIT TTT</i>
	32		11003529	HOPPER DOSER UNIT FRESH BREW <i>HOPPER DOSER UNIT FRESH BREW</i>
	33		126836618	SPRING H=28 NEW FOR SCRAPER <i>MOLLA H=28 NEW X RASCHIATORE</i>
	34		129851921	TSP SCREW M3X6 UNI 7688 SS <i>TSP SCREW M3X6 UNI 7688 SS</i>
	35		9161.037	LOWER PERCOLATOR FOR UNIT <i>DOCCIA INFERIORE X GRUPPO</i>
	36		11002626	ASS. COFFEE CONTAINER GREY 9 GR. <i>ASS. COFFEE CONTAINER GREY 9 GR.</i>
	37		9161.021.150	KEY FOR BREW UNIT GREY <i>KEY FOR BREW UNIT GREY</i>
	38		11007283	BREW UNIT 10GRAMS FRESH BREW <i>BREW UNIT 10GRAMS FRESH BREW</i>