

Model Machine

MACSAE055

SAECO ROYAL PROFESSIONAL

MACSAE055.T.0001



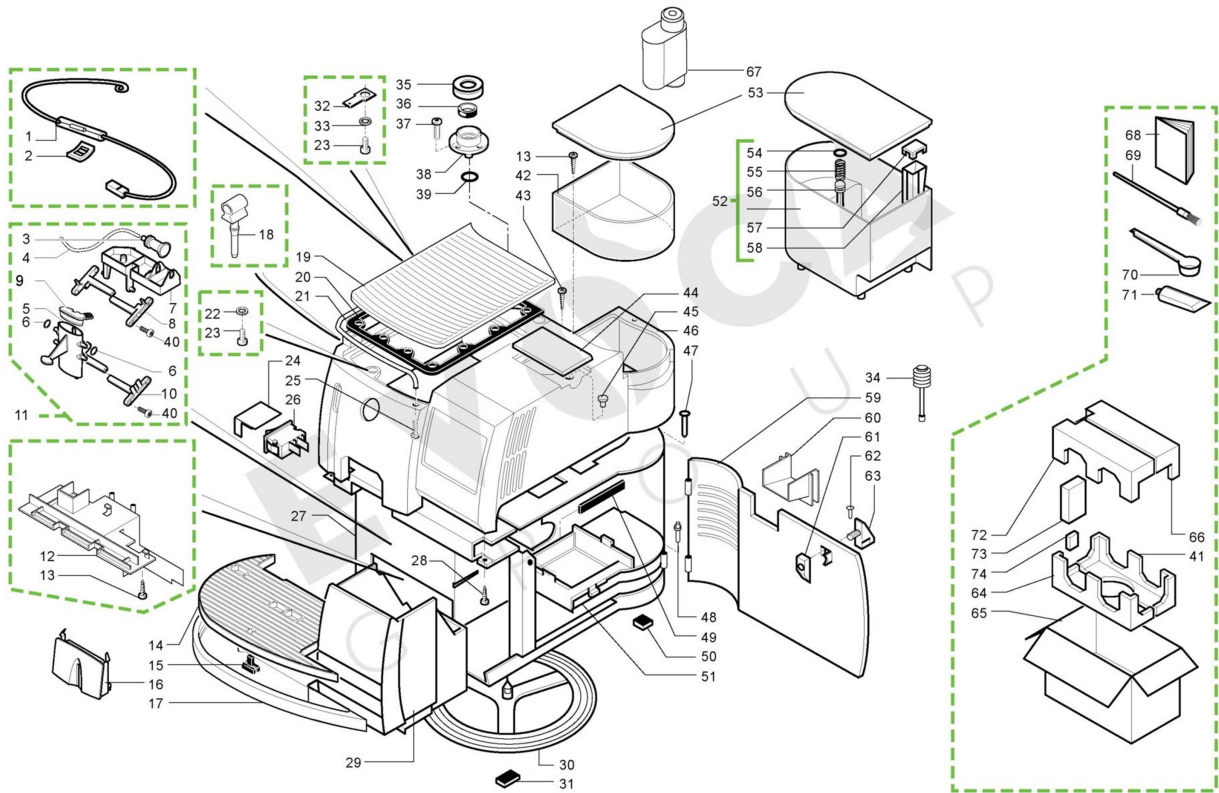









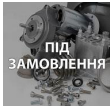

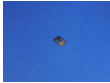



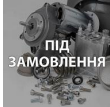





TAVOLA NR. 1 - ARTICOLO SAECO ROYAL PROFESSIONAL

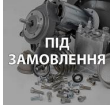

Model Machine

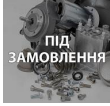
MACSAE055

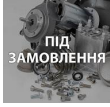























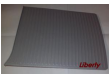

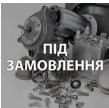
SAECO ROYAL PROFESSIONAL

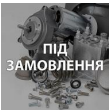
Web	Pos.	Foto	Item - Replace by	Description
				<i>Press - CTRL + CLICK go to item in a new window Натисніть - Ctrl + права кнопка миші щоб відкрити запчастину в новому вікні</i>
	1		0347.810	CONNECTOR 4 POLES CUPWARMER ASSY. CONNECTOR 4 POLES CUPWARMER ASSY.
	2		NF18.001	PLATE FOR PIN D.3,2 PLATE FOR PIN D.3,2
	3		0347.011.050	FIDEX SLEEVE MANICOTTO FISSO X EROG. NERO
	4		JS01.005	SILICONE TUBE 5X8 ROLL BROWN SILICONE TUBE 5X8 ROLL BROWN
	5		0347.006.710	MOBILE DISPENSER CASING GREY MOBILE DISPENSER CASING GREY
	6		NM02.010	OR ORM 0050-20 TERMOIL OR ORM 0050-20 TERMOIL
	7		0347.005.710	FIXED CASING DISPENSER BLACK FIXED CASING DISPENSER BLACK
	8		0347.A02.710	WHOLE MESH GREY UPPER DISP.RAL7021 WHOLE MESH GREY UPPER DISP.RAL 7021
	9		0360.024.050	CAP FOR BODY CAP FOR BODY
	10		0347.A05.710	WHOLE MESH GREY LOWER DISP. RAL7021 WHOLE MESH GREY LOWER DISP. RAL7021
	11		0347.A03.710	DISPENSER ASS. GREY RAL 7021 ASS.EROGATORE GRIGIO RAL 7021
	12		0301.033.150	TANK CASING GREY TANK CASING GREY

Model Machine

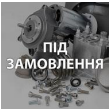
MACSAE055











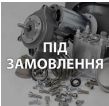

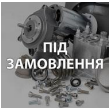







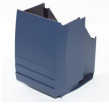





SAECO ROYAL PROFESSIONAL

	13		129670202	TCB PANELVIT SCREW 3,5X16 TESTA D=8 ZNP TCB PANELVIT SCREW 3,5X16 TESTA D=8 ZNP
	14		0347.009.430	CHROMATE GRID FOR TANK GRIGLIA X VASCA CROMATA
	15		0347.013.970	RED BALL FLOAT RED BALL FLOAT
	16		0347.004.430	CHROMATE DISPENSER COVER CHROMATE DISPENSER COVER
	17		0314.022.760	BLUE DRIP TRAY VASCA RACCOGLIGOCCE VERN.BLU
	17		0314.022.770	SILVER DRIP TRAY SILVER DRIP TRAY
	18		0312.016.050	RUBBER TUBE HOLDER BLACK RUBBER TUBE HOLDER BLACK
	19		0312.015.66A	230V-CLEAR/GREY CUPWARMING PLATE ASSY. ASS.PIASTRA SCALDATAZZE ARG. 230V
	19	 ПІД ЗАМОВЛЕННЯ	0312.015.66F	120V-CLEAR/GREY CUPWARMING PLATE ASSY. 120V-CLEAR/GREY CUPWARMING PLATE ASSY.
	20	 ПІД ЗАМОВЛЕННЯ	0312.014	CUPWARMER SEAL CUPWARMER SEAL
	21		0312.017	TUBE FOR CASING LID TUBE FOR CASING LID
	22	 ПІД ЗАМОВЛЕННЯ	U201.005	PLAIN WASHER 4,3X12 DIN 7349 GAL PLAIN WASHER 4,3X12 DIN 7349 GAL
	23		129573202	SCREW TCB TORX 20 M4X8 AUTOFORMING ZN-B SCREW TAPT M4X8 UNI 8112
	24		0327.036	GENERAL SWITCH PROTECTION GENERAL SWITCH PROTECTION

Model Machine

MACSAE055

















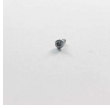

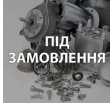

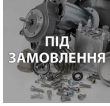

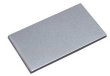

SAECO ROYAL PROFESSIONAL

	25		U043.012	SCREW TCB TORX 20 M4X6 ZN-B <i>VITE TCBC M4,0X6 UNI 7687 Z</i>
	26		NE03.038	BIPOLAR SWITCH FUSIT C1250AR <i>BIPOLAR SWITCH FUSIT C1250AR</i>
	27		11025913	BLUE CASING WITH SLOTS V2 ASSY. <i>BLUE CASING WITH SLOTS V2 ASSY.</i>
	27		11025915	SILVER CASING WITH SLOTS V2 ASSY. <i>SILVER CASING WITH SLOTS V2 ASSY.</i>
	28		U110.005	SCREW AUT.TCB 3,9X9,5 DIN 7981F <i>VITE AUT.TCB 3,9X9,5 DIN 798</i>
	29		11025950	ROYAL/BLUE DUMP BOX V2 <i>ROYAL/BLUE DUMP BOX V2</i>
	29		11025952	SILVER DUMP BOX V2 <i>SILVER DUMP BOX V2</i>
	30		0301.048.150	GREY ROTATING RING W/OUT FEET <i>GREY ROTATING RING W/OUT FEET</i>
	31		9991.096	ADHESIVE FOOT 8X15X3,2 <i>ADHESIVE FOOT 8X15X3,2</i>
	32		NE15.003	MALE TONGUE PLAIN 6,3 D.5,2 <i>LINGUETTA MASCHIO PIANA 6,3 D.5,2</i>
	33		128310402	GALV.WASHER UNI 8842 A4 <i>GALV.WASHER UNI 8842 A4</i>
	34		147700200	LOADING PUMP DIAMETER 17 MM <i>LOADING PUMP DIAMETER 17 MM</i>
	35		0701.031.150	GREY WATER VALVE GACO DIM 14 SEAL COVER <i>SEAL COVER GREY</i>
	36		145842900	NBR WATER CONT.VALVE GACO DIM14 SEAL <i>NBR WATER CONT.VALVE GACO DIM14 SEAL</i>

Model Machine

MACSAE055





















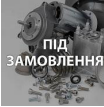

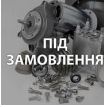



SAECO ROYAL PROFESSIONAL

	37		12000895	SCREW TSP TORX 10 3X10 PLAST.SS SCREW TSP TORX 10 3X10 PLAST.SS
	38		0701.014.150	GREY WATER VALVE GACO DIM 14 SEAL CONT. GREY WATER VALVE GACO DIM 14 SEAL CONT.
	39		140320461	OR ORM 0080-20 TERMOIL OR ORM 0080-20 IN TERMOIL
	40		129913202	SCREW TCB TORX 10 3X8 PLAST.ZN-B SCREW TCB TORX 10 3X8 PLAST.ZN-B
	41		0314.905	TECHMATE RIGHT LOWER INSERT TECHMATE RIGHT LOWER INSERT
	42		0317.010.230	COFFEE CONTAINER UL CONTENITORE CAFFE' UL
	42		0329.006.230	КОНТЕЙНЕР (БУНКЕР) ДЛЯ КАВИ КАВОВАРКИ SAECO 996530041763 CONTENITORE CAFFE'
	43		129512921	SCREW TCB TORX 10 AB 2,9X13 SHEET SS SCREW TCB TORX 10 2,9X13 SHEET SS
	44		0313.008.770	SILVER DOSER LID DIGITAL COPERCHIO DOSATORE DIGITAL ARG.
	44		0334.011.770	DOSER LID UL DIGITAL SILVER DOSER LID UL DIGITAL SILVER
	45		0312.013.050	PLUG FOR SCREW HOLE BLACK PLUG FOR SCREW HOLE BLACK
	46		0351.001.770	LID SAECO PROFESSIONAL SILVER LID SAECO PROFESSIONAL SILVER
	46		0366.002.770	LID SAECO PROFESSIONAL SILVER LID SAECO PROFESSIONAL SILVER

Model Machine

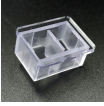
MACSAE055











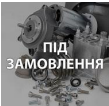

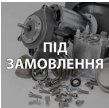













SAECO ROYAL PROFESSIONAL

	47		0301.019	NIK/BRASS PIN FOR DOOR SUPERAUT. <i>NIK/BRASS PIN FOR DOOR SUPERAUT.</i>
	48		0301.020	NIK/BRASS PIN FOR DOOR SUPERAUT. <i>NIK/BRASS PIN FOR DOOR SUPERAUT.</i>
	49		9161.140	SEAL FOR UNIT PLATE <i>GUARNIZIONE X PIASTRA GRUPPO</i>
	50		147623150	BLACK SQUARE ADHESIVE FOOT 5023 <i>BLACK SQUARE ADHESIVE FOOT 5023</i>
	51		0301.041.150	GREY BREW UNIT SUPPORT PLATE ROYAL <i>PIASTRA SUPPORTO GRUPPO GRIGIO</i>
	52	 ПІД ЗАМОВЛЕННЯ	0301.046.230	WATER TANK ASS. <i>ASS.SERBATOIO ACQUA SUPERAUTOMATICA</i>
	52	 ПІД ЗАМОВЛЕННЯ	0317.A16.230	WATER TANK ASS. MAGIC UL <i>WATER TANK ASS. MAGIC UL</i>
	53		20006540	KIT RIC.COP.CAF.ARG+COP.ACQ.ARG.ROYAL <i>KIT RIC.COP.CAF.ARG+COP.ACQ.ARG.ROYAL</i>
	54		NM01.032	ПРОКЛАДКА O-RING ORM 0060-30 ДЛЯ КАВОМАШИНИ ЧЕРВОНА SAECO... <i>OR ORM 0060-30 SILICONE ROSSA</i>
	55		9161.110	PISTON SPRING FOR SUPERAUT. <i>MOLLA X PISTONCINO SUPERAUTO</i>
	56		147660562	GREY PISTON FOR WATER CONTAINER VALVE <i>GREY PISTON FOR WATER CONTAINER VALVE</i>
	57		9161.050.230	NAT/TRANSP.FLOATING SPACE PLUGMAGIC <i>TAPPO X GALLEGGIANTE SUPERAUTOM.</i>
	58		9161.112.150	GREY LEVEL FLOAT <i>GALLEGGIANTE DI LIVELLO GRIGIO</i>
	59		0313.001.660	DOOR COVER S/SCREEN GREY <i>DOOR COVER S/SCREEN GREY</i>

Model Machine

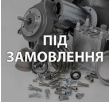
MACSAE055













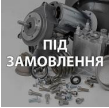









SAECO ROYAL PROFESSIONAL

	59		0313.001.760	DOOR ASS. ROYLA BLUE <i>DOOR ASS. ROYLA BLUE</i>
	60		0313.012.660	TF/SILVER DOOR COVER S/SCR.ROYAL <i>TF/SILVER DOOR COVER S/SCR.ROYAL</i>
	60		0313.012.760	BLUE DOOR COVER S/SCR.ROYAL <i>BLUE DOOR COVER S/SCR.ROYAL</i>
	61		0301.040.150	GREY DOOR CLOSURE LEVER <i>GREY DOOR CLOSURE LEVER</i>
	62		U433.001	NAIL 2X6 UNI 7591 BURN. <i>NAIL 2X06 UNI 7591 BURN.</i>
	63		0301.039.660	TF/SILVER DOOR CLOSURE KNOB <i>DOOR CLOSURE KNOB SILVER TF</i>
	63		0301.039.760	BLUE DOOR CLOSURE KNOB <i>BLUE DOOR CLOSURE KNOB</i>
	64		0314.904	TECHMATE LEFT LOWER INSERT <i>TECHMATE LEFT LOWER INSERT</i>
	65		13000873	AVANA EXTERNAL BOX ROYAL CAPP/PROF <i>AVANA EXTERNAL BOX ROYAL CAPP/PROF</i>
	66		0314.906	TECHMATE RIGHT UPPER INSERT <i>TECHMATE RIGHT UPPER INSERT</i>
	67		21001404	ACC SAE BRITA UNI.WAT.FILTERX1EUR-ASIA <i>ACC SAE BRITA UNI.WAT.FILTERX1EUR-ASIA</i>
	67		21001406	ACC SAE MAVEA UNI.WAT.FILTERX1USA <i>ACC SAE MAVEA UNI.WAT.FILTERX1 USA</i>
	68		0351.951	INST. BOOKLET DIGITAL D <i>INST. BOOKLET DIGITAL D</i>
	68		0351.952	INST. BOOKLET DIGITAL F <i>INST. BOOKLET DIGITAL F</i>

Model Machine

MACSAE055

SAECO ROYAL PROFESSIONAL



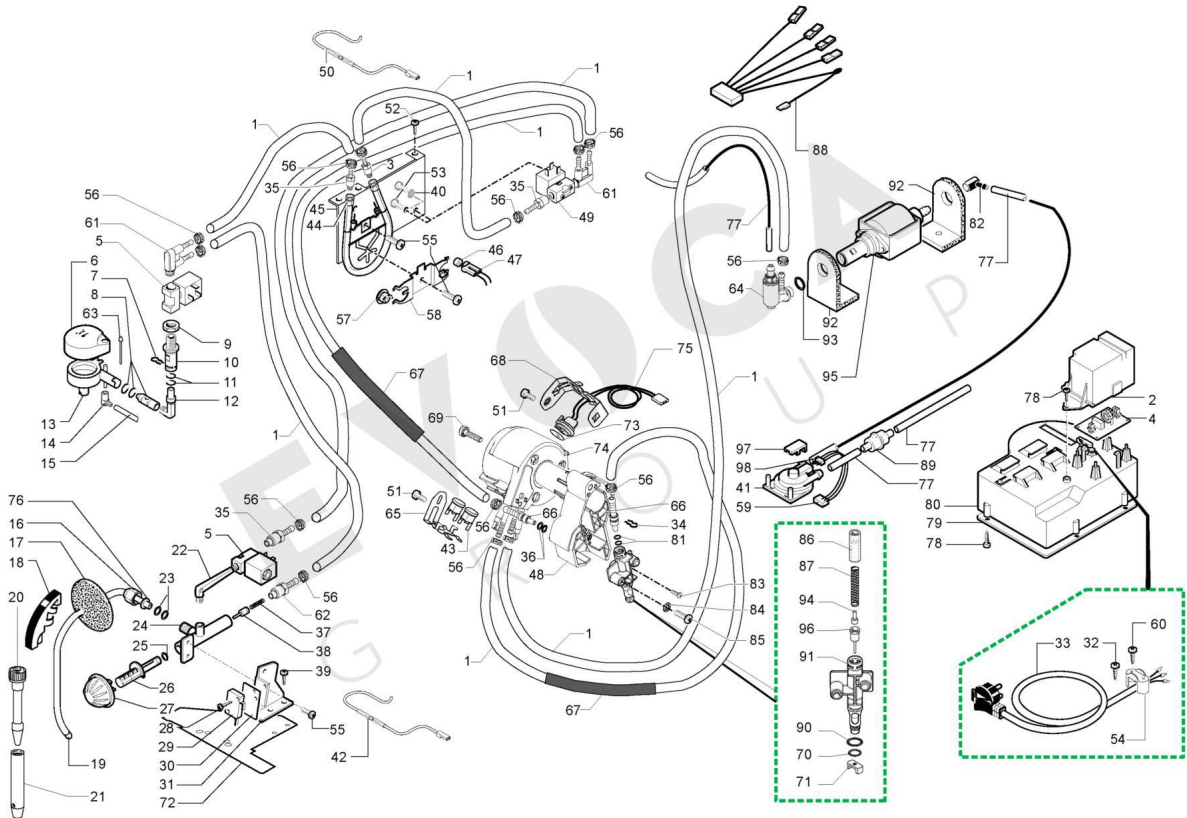























	68		0351.953	INST. BOOKLET DIGITAL I <i>INST. BOOKLET DIGITAL I</i>
	68		0351.954	INST. BOOKLET DIGITAL NL <i>INST. BOOKLET DIGITAL NL</i>
	68		0351.955	INST. BOOKLET DIGITAL GB <i>INST. BOOKLET DIGITAL GB</i>
	68		0351.956	INST. BOOKLET DIGITAL E <i>INST. BOOKLET DIGITAL E</i>
	68		0351.957	INST. BOOKLET DIGITAL P <i>INST. BOOKLET DIGITAL P</i>
	68		15002670	MANUAL PR ROYAL PROFES.ENG <i>MANUAL PR ROYAL PROFES.ENG</i>
	68		15002671	MANUAL PR ROYAL PROFES.FRA <i>MANUAL PR ROYAL PROFES.FRA</i>
	70		146680659	GREY MEASURE WITH HOLE <i>GREY MEASURE WITH HOLE</i>
	71		11005044	SAECO KLUBERLUB NH1 11-222 TUBE 5GR. <i>SAECO KLUBER TRIBOSTAR SIL 2 TUBE 5GR.</i>
	72		0314.907	TECHMATE LEFT UPPER INSERT <i>TECHMATE LEFT UPPER INSERT</i>
	73		0314.909	DRIP TRAY BOX <i>DRIP TRAY BOX</i>
	74		0330.906	SPACER IN POLYSTYRENE <i>SPACER IN POLYSTYRENE</i>



Model Machine

MACSAE055





























SAECO ROYAL PROFESSIONAL

Web	Pos.	Foto	Item - Replace by	Description
				<i>Press - CTRL + CLICK go to item in a new window Натисніть - Ctrl + права кнопка миші щоб відкрити запчастину в новому вікні</i>
	1		16000380	5X8,9 SILICONE TUBE IN ROLL 5X8,9 SILICONE TUBE IN ROLL
	2		9161.126.150	COVER FOR FILTER CARD GREY COVER FOR FILTER CARD GREY
	2		9161.336.150	COVER FOR FILTER CARD GREY UL COVER FOR FILTER CARD GREY UL
	3		11010261	TEA/BRASS INLET CONNECTOR BOILER TEA/BRASS INLET CONNECTOR BOILER
	4		0301.828.00F	FILTRATION CARD SUPERAUTOM. 120V SCHEDA FILTRAGGIO SUPERAUTOM
	4		0314.804	FILTRATION CARD 12A FILTRATION CARD 12A
	5		11008569	SOLEN.VALVE 15VA 2 WAY 1/8" FEM.TEA 230V SOLEN.VALVE 15VA 2 WAY 1/8" FEM.TEA 230V
	5		11008570	SOLEN.VALVE 21VA 2 WAY 1/8" FEM.TEA 120V SOLEN.VALVE 21VA 2 WAY 1/8" FEM.TEA 120V
	5		11008571	SOLEN.VALVE 15VA 2 WAY 1/8" FEM.TEA 100V SOLEN.VALVE 15VA 2 WAY 1/8" FEM.TEA 100V
	6		0314.018.710	COVER FOR CAPPUCINA. PAINTED GREY COVER FOR CAPPUCINA. PAINTED GREY
	6		0314.018.760	COVER FOR CAPPUCINATORE BLUE COPERTURA X CAPPUCINATORE B
	7		9161.135	SPRING FOR STEAM FAUCET MOLLA X RUBINETTO VAPORE
	8		142270200	TUBE+W/O RETAIN.CAPPUCINATORE+/2OR CANOTTO S/FERMO X CAPPUCINA OR 142270600, SAE307 , 140324461

Model Machine

MACSAE055























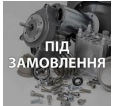

SAECO ROYAL PROFESSIONAL

	9		U303.002	NUT HEXAGONAL M12X1,25UNI 5589 <i>NUT HEXAGONAL M12X1,25UNI 5589</i>
	10		11008452	TEA/BRASS SUPPORT FOR 90°CONNECTOR <i>TEA/BRASS SUPPORT FOR 90°CONNECTOR</i>
	11		NM02.007	OR 2025 IN TERMOIL <i>OR 2025 TERMOIL</i>
	12		11008451	ПАТРУБОК ДЛЯ ВЗБИВАНИЯ SAECO ROYAL 996530004872 <i>TEA/BRASS 90°CONNECT.FOR CAPPUCCINATORE</i>
	13		142520130	CAPPUCCINATORE AS.NEUTRAL WHITE <i>AS.CAPPUCCINATORE NEUTRO BIANCO</i>
	14		9991.122.010	CONN. FOR CAPPUCCINATORE WHITE <i>RACCORDO X CAPPUCCINATORE BI</i>
	15		9972.045	SILICONE TUBE 3,5X6 L=350 MM DS <i>TUBO SILICONE 3,5X6 L.350 MM</i>
	16		9161.438	NUT FOR STEAM TUBE <i>NUT FOR STEAM TUBE</i>
	17		9161.058.150	INTERNAL PROTECTION FOR TUBE GREY <i>INTERNAL PROTECTION FOR TUBE GREY</i>
	18		9161.055.710	7021/GREY STEAM TUBE HANDGRIP <i>7021/GREY STEAM TUBE HANDGRIP</i>
	19		11004225	SS STEAM TUBE ROYAL ASSY. <i>STAINLESS STEEL STEAM TUBE ROYAL ASSY.</i>
	20		9990.005.050	PANNARELLO ASS.MIELE BLACK <i>PANNARELLO ASS.MIELE BLACK</i>
	21		9991.153	ЗОВНІШНЯ ПАНЕЛЬ PHILIPS SAECO 996530051861 <i>EXTERNAL COVER PANNAREL.CHROMED</i>
	22		11008453	TEA/BRASS 90° CONNECTOR FOR FAUCET EV. <i>TEA/BRASS 90° CONNECTOR FOR FAUCET EV.</i>

Model Machine

MACSAE055











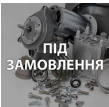

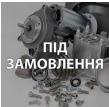













SAECO ROYAL PROFESSIONAL

	23		140324461	OR ORM 0060-20 TERMOIL <i>OR ORM 0060-20 IN TERMOIL</i>
	24		11009006	МЕТАЛЕВИЙ КОРПУС КРАНА PHILIPS SAECO 996530005168 <i>TEA/BRASS FAUCET BODY</i>
	25		140321461	O-RING 2018 EPDM <i>OR 2018 IN EPDM</i>
	26		9161.057	ШТОК КРАНА ПОДАЧІ ВОДИ/ПАРУ ДЛЯ КАВОВАРКИ SAECO <i>ASTA RUBINETTO VAPORE</i>
	27		0347.017.710	GREY STEAM KNOB RAL 7021 SERIG. <i>GREY STEAM KNOB RAL 7021 SERIG.</i>
	28		U109.027	SCREW TCB TORX 10 AB 2,9X19 SHEET SS <i>SCREW TCB TORX 10 AB 2,9X19 SHEET SS</i>
	29		NE05.013	МИКРОПЕРЕКЛЮЧАТЕЛЬ SAIA XGK52-81-J23 PHILIPS SAECO <i>MICROINTERRUTTORE</i>
	30		11009072	INSULATE PROTECTION 24X38,8 FOR MICRO <i>INSULATE PROTECTION 24X38,8 FOR MICRO</i>
	31		0312.011	STEEL STEAM FAUCET BRACKET ROYAL <i>STEEL STEAM FAUCET BRACKET ROYAL</i>
	32		U140.009	PANELVIT TCB 3,0X16 DIN 7505 BGAL <i>PANELVIT TCB 3,0X16 DIN 7505 B GAL</i>
	33		17800032	BLACK POWER CABLE BRAZIL L=1770 <i>BLACK POWER CABLE BRAZIL L=1770</i>
	33		NE01.112	BLACK POWER CABLE TAIWAN L=1500 <i>BLACK POWER CABLE TAIWAN L=1500</i>
	33		NE01.114	POWER CABLE AUSTRALIA <i>POWER CABLE AUSTRALIA</i>

Model Machine

MACSAE055













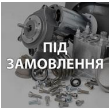













SAECO ROYAL PROFESSIONAL

	33		NE01.118	BLACK POWER CABLE CH L=1500MM <i>BLACK POWER CABLE CH L=1500MM</i>
	33		NE01.120	BLACK POWER CABLE SCHUKO L=1500 <i>BLACK POWER CABLE SCHUKO L=1500</i>
	34		9011.144	SS FORK FOR TUBE D=4 <i>FORCELLA X TUBO D.4</i>
	35		11006304	TEA/BRASS CONNECTOR FOR ALUM.BOILER <i>TEA/BRASS CONNECTOR FOR ALUM.BOILER</i>
	36		140328059	OR 2015 SILICONE PTFE/FDA <i>OR 2015 SILICONE PTFE/FDA</i>
	37		126765317	STEEL SPRING BOILER PISTON MAGIC <i>STEEL SPRING BOILER PISTON MAGIC</i>
	38		11009018	TEA/BRASS PISTON L=15,1 ASSY. <i>TEA/BRASS PISTON L=15,1 ASSY. NUOVO PREZZO 2,42 SAECO</i>
	39		U110.013	БОЛТ МЕТАЛЕВИЙ 3,9X6,5 DIN 7981 F <i>SCREW AUT.TCB 3,9X6,5 DIN 7981 F</i>
	40		128310404	МЕТАЛЕВЕ УБЧАСТЕ КОЛІЩАТКО UNI 8842 A4 <i>WASHER UNI 8842 A4 BURNISHED</i>
	41		286473300	-M-VDE TURBINE WITH SENSOR KIT <i>KIT TURBINA VDE "M" C/SENS.M</i>
	42		0354.809	CABLE 1WIRE SILIC.BLUE TH/FUSE192° <i>CABLE 1WIRE SILIC.BLUE TH/FUSE 192°</i>
	43		189428200	THERMOSTAT 175° 1NT-08L-3794 <i>THERMOSTAT 175° 1NT-08L-3794</i>
	44		11010390	BLECKMANN BOILER V2 PROFESS.230V ASSY. <i>BLECKMANN BOILER V2 PROFESS.230V ASSY.</i>
	44		11010391	BLECKMANN BOILER V2 PROFESS.120V ASSY. <i>BLECKMANN BOILER V2 PROFESS.120V ASSY.</i>

Model Machine

MACSAE055























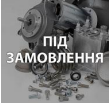

SAECO ROYAL PROFESSIONAL

	44		11010392	BLECKMANN BOILER V2 PROFESS.100V ASSY. <i>BLECKMANN BOILER V2 PROFESS.100V ASSY.</i>
	45		0334.001	NEW SYSTEM BRACKET <i>NEW SYSTEM BRACKET</i>
	46		11004424	ALUM.SPACER FOR PHILIPS SENSORM5000 <i>ALUM.SPACER FOR PHILIPS SENSOR M5000</i>
	47		9019.A72	SENSOR ROYAL ASSY. <i>SENSOR ROYAL ASSY.</i>
	47		9019.A73	SENSOR ROYAL UL ASSY. <i>SENSOR ROYAL UL ASSY.</i>
	48		11010338	СУПОРТ БОЙЛЕРА SAECO 9161.435 <i>BLACK TUBOL BOILER SUPPORT V2 FOR ROYAL</i>
	49		11008573	SOLEN.VALVE 15VA 2W.1/8"FEM.DN3 TEA 230V <i>SOLEN.VALVE 15VA 2W.1/8 FEM.DN3 TEA 230V</i>
	49		11008574	SOLEN.VALVE 21VA 2W.1/8"FEM.DN3 TEA 120V <i>SOLEN.VALVE 21VA 2W.1/8"FEM.DN3 TEA 120V</i>
	49		11008575	SOLEN.VALVE 15VA 2W.1/8"FEM.DN3 TEA 100V <i>SOLEN.VALVE 15VA 2W.1/8"FEM.DN3 TEA 100V</i>
	50		0334.822	CABLE 1 WIRE SILIC.WHITE TH/FUSE 216° <i>CABLAGGIO BIANCO C/TERMOFUS.</i>
	50		0334.823	CABLE 1WIRE SIL.WHYTE AWG16 TH/FUSE 216° <i>CABLE 1WIRE SIL.WHYTE AWG16 TH/FUSE 216f</i>
	51		129573202	SCREW TCB TORX 20 M4X8 AUTOFORMING ZN-B <i>SCREW TAPT M4X8 UNI 8112</i>
	52		U110.004	SCREW AUT.TCB 3,5X6,5 DIN 7981F <i>VITE AUT.TCB 3,5X6,5 DIN 7981 F NIK</i>
	53		U043.012	SCREW TCB TORX 20 M4X6 ZN-B <i>VITE TCBC M4,0X6 UNI 7687 Z</i>

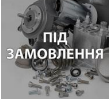
Model Machine

MACSAE055













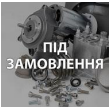









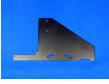



SAECO ROYAL PROFESSIONAL

	54		9991.039	CABLE RETAINER UL CABLE RETAINER UL
	55		U046.003	SCREW TCBD TORX 20 M4X12 ZN-B VITE TCBC M4,0X12 ROND.DENT.
	56		12000892	ЗАЖИМ D.9,5 16700004 OETIKER CLAMP D=9,5 16700004 (L250)
	57		NE09.006	THERMOSTAT 170°C FAST. 90°+WASHER TERMOST.170°C FASTON 90°C/R
	58		9011.187	THERMOSTAT RETAINING SPRING THERMOSTAT RETAINING SPRING
	59		0347.817	3POLES CONNECTOR TURBINE ASSY. 3POLES CONNECTOR TURBINE ASSY.
	59		0348.808	CONNECTOR 3 POLES TURBINE UL ASSY. CONNECTOR 3 POLES TURBINE UL ASSY.
	60		U109.005	SCREW AUT.TCB 3,5X16 DIN 7981C VITE AUT.TCB 3,5X16 DIN 798
	61		11010243	TEA/BRASS 90° DOUBLE CONNECTOR TEA/BRASS 90° DOUBLE CONNECTOR
	62		11011243	TEA/BRASS CONNECTOR FOR FAUCET TEA/BRASS CONNECTOR FOR FAUCET
	63		148870130	WHITE CAPPUCCINATORE PIN SPILLO X CAPPUCCINATORE BIANCO
	64		11004689	TEA/BRASS SAFETY VALVE 16-18 BAR ASSY. SAFETY VALVE 16-18 BAR P0049 ASSY.
	65		126838117	2 THERMOSTATS FIXING SPRING MOLLA FERMA 2 TERMOSTATI

Model Machine

MACSAE055

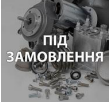











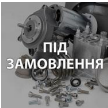



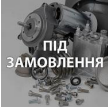







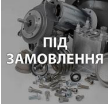

SAECO ROYAL PROFESSIONAL

	66		11000750	TEA/BRASS CONNECTOR FOR SILICONE TUBE <i>TEA/BRASS CONNECTOR FOR SILICONE TUBE</i>
	67		16000540	TRANSPAR.11X12,8 SILICONE TUBE IN ROLL <i>TRANSPAR.11X12,8 SILICONE TUBE IN ROLL</i>
	68		126838017	SENSOR FIXING SPRING <i>SENSOR FIXING SPRING</i>
	69		129932202	ROUND HEAD SCREW 10.9 M5X20 GALV <i>ROUND HEAD SCREW 10.9 M5X20 GALV</i>
	70		NM01.057	OR ORM 0050-20 IN SILICONE <i>OR ORM 0050-20 IN SILICONE</i>
	71		11005099	NATURAL CURSOR V2 FOR BOILER P119 <i>NATURAL CURSOR V2 FOR BOILER P119</i>
	72		11000839	BLACK CLOSURE PLATE <i>BLACK CLOSURE PLATE</i>
	73		145951600	ELECTRIC INSULATING D=16 SP=0,4 <i>ELECTRIC INSULATING DISK D=16</i>
	74		11004667	V5 TUB. BOILER W/ADDIT. RESIST. 1100W 230V <i>V5 TUB. BOILER W/ADDIT. RESIST. 1100W 230V</i>
	74		11004668	V5 TUB. BOILER W/ADDIT. RESIST. 1100W 100V <i>V5 TUB. BOILER W/ADDIT. RESIST. 1100W 100V</i>
	74		11004669	V5 TUB. BOILER W/ADDIT. RESIST. 1100W 120V <i>V5 TUB. BOILER W/ADDIT. RESIST. 1100W 120V</i>
	75		288582300	ТЕМПЕРАТУРНИЙ ДАТЧИК З ЖОВТИМИ ПРОВОДАМИ SAECO <i>SENSOR ELECT. BOARD WITH CONNECTOR ASSY.</i>
	76		9161.444	SPACER <i>SPACER</i>
	77		JS01.022	SILICONE TUBE 5X10 60SH IN ROLL <i>SILICONE TUBE 5X10 60SH IN ROLL</i>

Model Machine

MACSAE055

























SAECO ROYAL PROFESSIONAL

	78		129670202	TCB PANELVIT SCREW 3,5X16 TESTA D=8 ZNP <i>TCB PANELVIT SCREW 3,5X16 TESTA D=8 ZNP</i>
	79	 ПІД ЗАМОВЛЕННЯ	421944039591	LID FOR POWER CABLE CONT.V2 GREY <i>LID FOR POWER CABLE CONT.V2 GREY</i>
	80	 ПІД ЗАМОВЛЕННЯ	421946018581	POWER CABLE CONT.V2 VDE GREY <i>POWER CABLE CONT.V2 VDE GREY</i>
	80	 ПІД ЗАМОВЛЕННЯ	421946018591	POWER SUPPLY CABLE V2 GREY UL <i>POWER SUPPLY CABLE V2 GREY UL</i>
	81		140326662	OR ORM 0040-20 SILICONE <i>OR METRIC 0040-20 IN SILICONE</i>
	82		147920150	90° INLET PUMP CONNECTOR <i>RACCORDO A 90° IN SANTOPRENE</i>
	83		U140.004	PANELVIT TCB 3,0X12 DIN 7505 BGAL <i>PANELVIT TCB 3,0X12 DIN 7505 B ZNP</i>
	84	 ПІД ЗАМОВЛЕННЯ	128310521	WASHER UNI 8842 A5 SS <i>WASHER UNI 8842 A5 SS</i>
	85	 ПІД ЗАМОВЛЕННЯ	U043.030	SCREW TCBC M5,0X30 UNI 7687 GALV. <i>SCREW TCBC M5,0X30 UNI 7687 GALV.</i>
	86		11009012	TEA/BRASS BOILER PIN BUSH <i>TEA/BRASS BOILER PIN BUSH</i>
	87		9011.132	SS SPRING FOR PIN <i>MOLLA X SPILLO</i>
	88		0334.803	CONN.ASS. 5POLE <i>CONN.ASS. 5POLE</i>
	88	 ПІД ЗАМОВЛЕННЯ	0334.810	CONN.ASS. 5POLE UL <i>CONN.ASS. 5POLE UL</i>
	89		144650300	ФІЛЬТР ОЧИСТКИ ВОДИ ДЛЯ КАВОМАШИНИ SAECO NEW (NV99.001) (88... <i>ASPIRATION FILTER GAUZE NET 500 (NEW)</i>

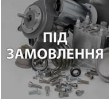
Model Machine

MACSAE055

SAECO ROYAL PROFESSIONAL

	90		NM01.035	OR ORM 0090-20 SILICONE OR ORM 0090-20 SILICONE
	91		9161.434	HOT WATER PIN PERNO CALDAIA MAGIC,ROYAL SAECO
	92	 ПІД ЗАМОВЛЕННЯ	11001302	BLACK PUMP SUPPORT W/LOCKING P124 BLACK PUMP SUPPORT W/LOCKING P124
	93		140321961	ПРОКЛАДКА O-RING ДЛЯ КАВОМАШИНИ SAECO 2031 TERMOIL OR 2031 IN TERMOIL
	94		11009013	TEA/BRASS PIN FOR PISTON L=10 TEA/BRASS PIN FOR PISTON L=10
	95	 ПІД ЗАМОВЛЕННЯ	12000130	ULKA PUMP EP5/S GW 100V-50/60HZ ULKA PUMP EP5/S GW 100V-50/60HZ
	95		12000131	ULKA PUMP EP5/S 120V-60HZ ULKA PUMP EP5/S 120V-60HZ
	95	 ПІД ЗАМОВЛЕННЯ	12000140	PUMP 230V-50HZ ULKA PUMP EP5/S GW 230V-50HZ
	95	 ПІД ЗАМОВЛЕННЯ	12000167	ULKA PUMP EP5/S GW 240V-50HZ ULKA PUMP EP5/S GW 240V-50HZ
	95	 ПІД ЗАМОВЛЕННЯ	12000182	ULKA PUMP EP5/S GW 220V-60HZ ULKA PUMP EP5/S GW 220V-60HZ
	96		11009019	TEA/BRASS PISTON L=20,9 ASSY. TEA/BRASS PISTON L=20,9 ASSY.
	97		9161.018	BRACKET FOR TURBINE BRACKET FOR TURBINE
	10001	 ПІД ЗАМОВЛЕННЯ	11010324	BOILER V2 PROFESSIONAL 120V ASSY. BOILER V2 PROFESSIONAL 120V ASSY.

Model Machine

MACSAE055

SAECO ROYAL PROFESSIONAL



10001

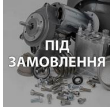

11010325

BOILER V2 PROFESSIONAL 100V ASSY.

BOILER V2 PROFESSIONAL 100V ASSY.



10001



11010379

BOILER V2 PROFESSIONAL 230V ASSY.



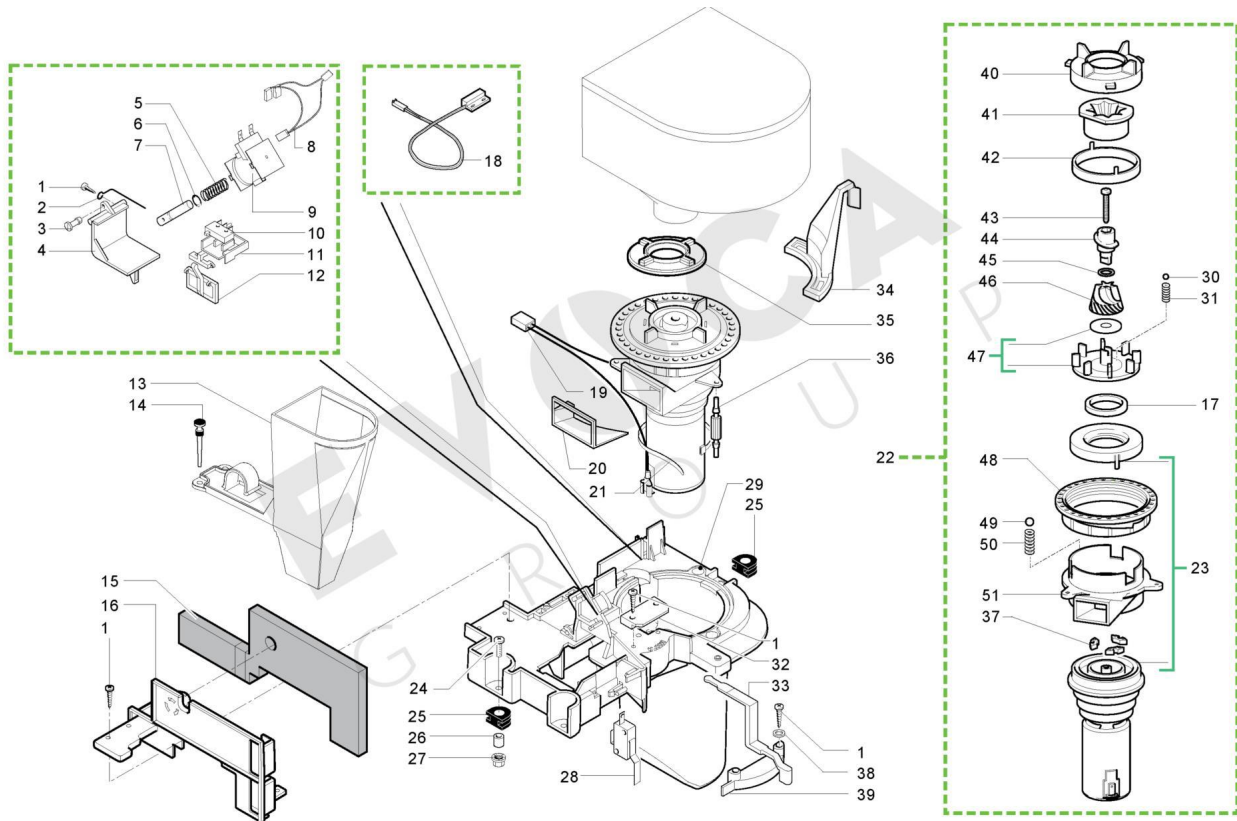























BOILER V2 PROFESSIONAL 230V ASSY.

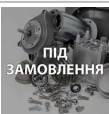

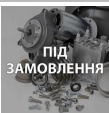
Model Machine

MACSAE055











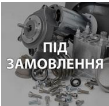















SAECO ROYAL PROFESSIONAL

Web	Pos.	Foto	Item - Replace by	Description
				<i>Press - CTRL + CLICK go to item in a new window Натисніть - Ctrl + права кнопка миші щоб відкрити запчастину в новому вікні</i>
	1		U140.004	PANELVIT TCB 3,0X12 DIN 7505 BGAL PANELVIT TCB 3,0X12 DIN 7505 B ZNP
	2		9161.048	STEEL GROUND COF.DOSER SCRAPERROD ASTA RASATORE
	3		9161.076.150	GREY GROUND COF.DOSER DOOR PIN PERNO SPORTELLO DOSATORE GRIGIO
	4		9161.074.150	GREY GROUND COFFE DOSER DOOR SPORTELLO DOSATORE GRIGIO
	5		126764818	ПРУЖИНА ЕЛЕКТРОМАГНІТНОГО ДОЗАТОРА ЗЕРНА MAGIC SAECO 916... SPRING ELECTROM.BEAN DOSER MAGIC
	6		U701.003	SNAP RING 7 UNI 7434 ANELLO ELASTICO 7 UNI 7434
	7		9161.041	STEEL GROUND COF.DOSER ELECTROMAGN.CORE NUCLEO ELETTRROMAGNETE DOSATORE
	8		0301.866	CONNECTOR ASS. 2 POLE DOSER COIL CONNECTOR ASS. 2 POLE DOSER COIL
	9	 ПІД ЗАМОВЛЕННЯ	9129.A07.00F	COFFEE DOSER COIL ASS.120V COFFEE DOSER COIL ASS.120V
	9	 ПІД ЗАМОВЛЕННЯ	9129.A21.00A	DOSER COIL FOR SUPERAUTOM.230VASSY. DOSER COIL FOR SUPERAUTOM.230V ASSY.
	10		NE05.017	MICROSWITCH MICROSWITCH NE05.017
	11		9161.072.150	GREY MICRO SUPP.CURSOR GROUND COF.DOSER MICRO SUPPORT CURSOR GREY
	12		9161.073.150	GREY GROUND COF.DOSE CONTROL COMPENSATOR DOSE CONTROL COMPENSATOR GREY

Model Machine

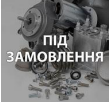
MACSAE055

















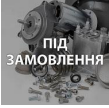







SAECO ROYAL PROFESSIONAL

	13		9161.223.150	COMPL.HOPP.FOR POWDER COFFEE GRE. <i>COMPL.HOPP.FOR POWDER COFFEE GRE.</i>
	14		9161.082	RUBBER COUPLER <i>AGGANCIO IN GOMMA</i>
	15		9161.382	INSULATOR FOR COFFEE GRINDER <i>INSULATOR FOR COFFEE GRINDER</i>
	16		9161.366.150	GREY/7016 SUPPORT FOR INSULATOR <i>SUPPORTO X ISOLANTE GRIGIO</i>
	17		140360200	FELT RING 40X34X5 <i>ANELLO IN FELTRO DE=40 DI=34</i>
	18		0301.811	CONNECTOR 2 POLES LEVEL ASSY. <i>SENSORE ASS.2 POLI LIVELLO</i>
	18		283551955	2POL.WATER LEVEL SENSOR SMARTUL ASSY. <i>2POL.WATER LEVEL SENSOR SMART UL ASSY.</i>
	19		0301.868	2P.CONNECTOR COFFEE GRINDER ROYAL UL <i>2P.CONNECTOR COFFEE GRINDER ROYAL UL</i>
	19		0301.869	CONNECTOR ASS. 2 POLE COFFEEGRINDE <i>CONNECTOR ASS. 2 POLE COFFEEGRINDE</i>
	20		1505.014	COFFEEGRINDER SEAL <i>GUARNIZIONE DOSATORE</i>
	21		144320200	SELF LOCK STRIP W=2.6 L=200 <i>SELF LOCK STRIP W=2.6 L=200</i>
	22		9140.035.00A	ASS.MACINACAFFE'ITA 230V <i>ASS.MACINACAFFE'ITA 230V</i>
	22		9140.036.00A	КАВОМОЛКА В ЗБОРІ 230V PHILIPS SAECO 996530065687 <i>COFFEE GRINDER STD 230V ASSY.</i>
	22		9140.036.00F	ASS.MOTOR STD 120V <i>ASS.MOTOR STD 120V</i>

Model Machine

MACSAE055























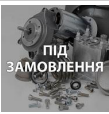

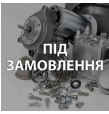

SAECO ROYAL PROFESSIONAL

	22		9140.036.00R	ASS.MOTOR STD 100V 50/60HZ ASS.MOTOR STD 100V 50/60HZ
	23		0301.R10.00A	SPARE MOTOR UNIT MC 230V GRUPPO RICAMBIO MOTORE MC 230 V
	23		1501.R09.00F	MOTOR SPARE UNIT 120V MOTOR SPARE UNIT 120V
	23		1501.R09.00R	MOTOR SPARE UNIT 100V MOTOR SPARE UNIT 100V
	24		U043.004	ZN-B TCB TORX 20 M4X16 ZN-B VITE TCBC M4,0X16 UNI 7687 ZNP
	25		9991.005	RUBBER FOR COFFEE GRINDER GOMMINO X MACINA CAFFE
	26		9141.003	SPACER FOR RUBBER SPACER FOR RUBBER
	27		U324.006	ШАЙБА M4 NUT M4 FLANGED INDENTED BASE
	28		NE05.037	MICROSWITCH MICROINTERRUTTORE
	29		9161.365.150	GREY PLATE COFFEEGRINDER MAGIC/ROYAL PIASTRA X MACINACAFFE' GRIGIO/7016
	30		128610521	STAIL.STEEL AISI 304 SPHERE D=5,5MM SFERA D=5,5MM ACCIAIO INOX A
	31		126765517	STEEL SPRING SPHERE D=5,5 MOTOR MAGIC MOLLA ACC.X SFERA D=5,5 MOTO
	32		9161.097.150	GREY GROUND COF.DOSER LEVER FIXING PLATE LEVER FIXING PLATE GREY

Model Machine

MACSAE055

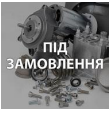
SAECO ROYAL PROFESSIONAL

	33		0313.003.150	7016/GREY GROUND COF.DOSER ADJUSTM.LEVER <i>LEVA DI REGOLAZIONE GRIGIO R</i>
	34		9161.080.910	GRINDING ADJUSTM.LEVER SILV.TURMIX <i>GRINDING ADJUSTM.LEVER SILV.TURMIX</i>
	35		1505.020	ГУМОВИЙ УЦІЛЬНЮВАЧ КАВОМОЛКИ PHILIPS SAECO 996530046547 <i>GASKET COFFEE GRINDER UL</i>
	36		9991.103	АМОТИЗАТОР ДЛЯ КОФЕМОЛКИ КОФЕМАШИН PHILIPS SAECO 996530... <i>AMMORTIZZATORE PER MACINACAFE</i>
	37		140230400	SHOCK ABS .CONICAL GRINDER SUPP.MAGIC <i>AMMORTIZ.X SUPPOR.MACIN.CONI</i>
	38		U201.001	PLAIN WASHER 3,2X9 DIN 7349 GALV. <i>PLAIN WASHER 3,2X9 DIN 7349 GALV.</i>
	39	 ПІД ЗАМОВЛЕННЯ	9161.403.150	GREY COFFEE DOSE ADJUSTMENT SCALE <i>GREY COFFEE DOSE ADJUSTMENT SCALE</i>
	40		149186150	BLACK UPPER GRINDER SUPPORT MAGIC <i>SUPPORT.NER.X MACINA SUPERIO</i>
	42		142844550	UPPER GRINDER COVER COFFEE GRIND. MAGIC <i>UPPER GRINDER COVER COFFEE GRIND. MAGIC</i>
	43	 ПІД ЗАМОВЛЕННЯ	129931002	TORX SCREW T10 TCB 3,5X40 SX ZNG <i>TORX SCREW T10 TCB 3,5X40 SX ZNG</i>
	44		147470763	BLK INCREASE SCREW PIN COF.GRINDER MAGIC <i>PERNO INCREM.A VITE X MACINA</i>
	45		U201.002	PLAIN WASHER 10X16X0,2DIN 988GAL <i>ROSETTA PIANA 10X16X0,2DIN</i>
	46	 ПІД ЗАМОВЛЕННЯ	226473500	KIT TECNA GRINDERS <i>KIT TECNA GRINDERS</i>
	47	 ПІД ЗАМОВЛЕННЯ	149188750	CONICAL GRIND. SUPP. + RING MAGIC <i>CONICAL GRIND. SUPP. + RING MAGIC</i>

Model Machine

MACSAE055

SAECO ROYAL PROFESSIONAL

	48		146570950	RING NUT FOR GRINDING ADJUSTMENT MAGIC <i>GHIERA NERA REGOLAZ.MACINATU</i>
	49		128610421	STAIL.STELL AISI 304 SPHERE D=3,2MM <i>SFERA D=3,2MM ACCIAIO INOX A</i>
	50		126770117	NEW SPRING SPHERE D=3,2 MOTORMAGIG <i>MOLLA NEW X SFERA D=3,2 MOTORE MAGIC</i>
	51	 ПІД ЗАМОВЛЕННЯ	9141.080	ТРИМАЧ ДВИГУНА КАВОМОЛКИ ДЛЯ КАВОВАРКИ SAECO 9141.080 <i>SUPPORTO MOTORE</i>

Model Machine

MACSAE055

SAECO ROYAL PROFESSIONAL

MACSAE055.T.0004



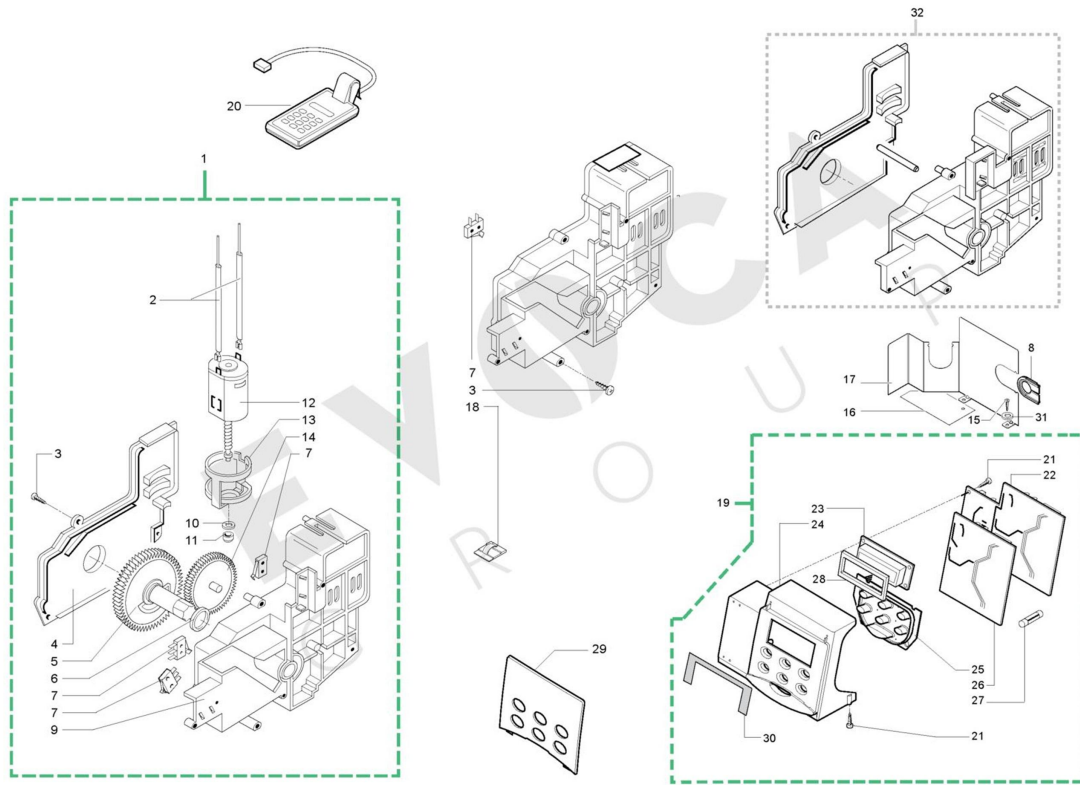









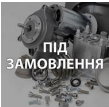

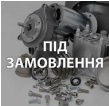











TAVOLA NR. 4 - ARTICOLO SAECO ROYAL PROFESSIONAL



Model Machine

MACSAE055

















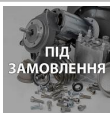

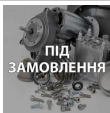



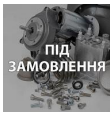

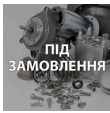

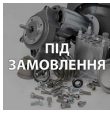
SAECO ROYAL PROFESSIONAL

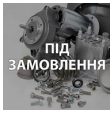
Web	Pos.	Foto	Item - Replace by	Description
				<i>Press - CTRL + CLICK go to item in a new window Натисніть - Ctrl + права кнопка миші щоб відкрити запчастину в новому вікні</i>
	1		9120.051.150	WIRED RATIOMOTOR ROYAL GREY ASSY. <i>WIRED RATIOMOTOR ROYAL GREY ASSY.</i>
	1		9120.057.150	WIRED RATIOMOTOR ROYAL UL ASSY. <i>WIRED RATIOMOTOR ROYAL UL ASSY.</i>
	3		129670202	TCB PANELVIT SCREW 3,5X16 TESTA D=8 ZNP <i>TCB PANELVIT SCREW 3,5X16 TESTA D=8 ZNP</i>
	4		17000719	GREY RATIOMOTOR LID RYL <i>GREY RATIOMOTOR LID RYL</i>
	5		9121.069.150	GEAR Z=108 FOR MOUNTING PLATEM4000 <i>INGRANAG.Z=108 PIASTRA MONT.M4000 GRIGIO</i>
	6		9161.368	MYLAR WASHER FOR RATIOMOTOR <i>RONDELLA MYLAR X MOTORIDUTTORE</i>
	7		NE05.038	MICROSWITCH 30V 0.3A <i>MICROINTERRUTTORE</i>
	8		9161.429	PASSACAVO GRANDE X SQUADRETTA <i>PASSACAVO GRANDE X SQUADRETTA</i>
	9		11027899	GREY RATIOMOTOR CASING W/DUCTV2 ASSY. <i>GREY RATIOMOTOR CASING W/DUCT V2 ASSY.</i>
	10		148380200	BAKELIZZATE WASHER D=5,5 <i>BAKELIZZATE WASHER D=5,5</i>
	11		9121.046	BRONZE SINTERED BUSH FOR MOTORRATIOMOT. <i>BRONZE SINTERED BUSH FOR MOTOR RATIOMOT.</i>
	12		9120.053	MOTOR FOR RATIOMOTOR ROYAL ASSY. <i>ASS.MOTORE X MOTORIDUTTORE ROYAL</i>
	12		9120.059	GEN.MOTOR FOR RATIOMOTOR ROYALDGT UL AS <i>GEN.MOTOR FOR RATIOMOTOR ROYAL DGT UL AS</i>

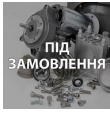
Model Machine

MACSAE055























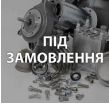

SAECO ROYAL PROFESSIONAL

	13		9121.044	ANTIVIBRATION FOR MOTOR <i>ANTIVIBRANTE X MOTORE</i>
	14		9121.042	GEAR Z=12/90 <i>INGRANAGGIO Z.12/90 PREZZO NUOVO 0,33</i>
	15		U110.004	SCREW AUT.TCB 3,5X6,5 DIN 7981F <i>VITE AUT.TCB 3,5X6,5 DIN 7981 F NIK</i>
	16	 ПІД ЗАМОВЛЕННЯ	0360.025	MYLAR GUARD FOR ELECTRONICS <i>MYLAR GUARD FOR ELECTRONICS</i>
	17	 ПІД ЗАМОВЛЕННЯ	9161.427.050	PROTECTION BRACKET <i>PROTECTION BRACKET</i>
	18		NE17.002	ADH.CABLE RETAI.ROUND CABLE D=10MM <i>ADH.CABLE RETAI.ROUND CABLE D=10MM</i>
	19	 ПІД ЗАМОВЛЕННЯ	0351.R03.77A	SPARES WHOLE ELECTRONICS <i>SPARES WHOLE ELECTRONICS</i>
	19	 ПІД ЗАМОВЛЕННЯ	0351.R03.77F	SPARES WHOLE ELECTRONICS <i>SPARES WHOLE ELECTRONICS</i>
	19	 ПІД ЗАМОВЛЕННЯ	0351.R03.77R	SPARES WHOLE ELECTRONICS <i>SPARES WHOLE ELECTRONICS</i>
	19	 ПІД ЗАМОВЛЕННЯ	0351.R04.77A	SPARES WHOLE ELECTRONICS <i>SPARES WHOLE ELECTRONICS</i>
	20	 ПІД ЗАМОВЛЕННЯ	20000922	KIT COMPLETE PROGRAMMER SW SERKIT <i>KIT COMPLETE PROGRAMMER SW SERKIT</i>
	21		129913202	SCREW TCB TORX 10 3X8 PLAST.ZN-B <i>SCREW TCB TORX 10 3X8 PLAST.ZN-B</i>
	22		0351.804.00A	POWER CARD ROYAL PROFESSIONAL230V <i>SCHEDA POWER ROYAL PROFESS.230V</i>
	22	 ПІД ЗАМОВЛЕННЯ	0351.804.00F	POWER CARD ROYAL PROFESSIONAL120V <i>POWER CARD ROYAL PROFESSIONAL 120V</i>

Model Machine

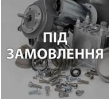
MACSAE055

SAECO ROYAL PROFESSIONAL

	23		0347.816	DISPLAY FOR ROYAL REDESIGN <i>DISPLAY FOR ROYAL REDESIGN</i>
	24		11006458	SILVER ELECTRONICS SUPPORT ROYAL <i>SILVER ELECTRONICS SUPPORT ROYAL</i>
	25		0348.801	WHOLE KEYBOARD DIGITAL PLUS <i>ASS.TASTIERA DIGITAL PLUS</i>
	26		0351.803	CPU/TOUCH PANEL PROFESSIONAL <i>CPU/TOUCH PANEL PROFESSIONAL</i>
	26		0351.808	CPU/TOUCH PANEL PROFESSIONAL ITA <i>CPU/TOUCH PANEL PROFESSIONAL ITA</i>
	26		0351.820	CPU/TOUCH PANEL PROFESSIONAL <i>CPU/TOUCH PANEL PROFESSIONAL</i>
	26		0351.821	CPU/TOUCH PANEL PROFESSIONAL <i>CPU/TOUCH PANEL PROFESSIONAL</i>
	27		184950300	FUSE T32 M.AMP.5X20 DELAYED <i>FUSE T32 M.AMP.5X20 DELAYED</i>
	27		184950400	FUSE T8 AMP.5X20 SAND-BLASTED <i>FUSE T8 AMP.5X20 SAND-BLASTED</i>
	28		149090500	DOUBLE SIDED ADHESIVE STRIP <i>DOUBLE SIDED ADHESIVE STRIP</i>
	29		0351.002.770	SILVER SERIGRAPHED ESCUTCHEON <i>SILVER SERIGRAPHED ESCUTCHEON</i>
	29		0354.004.770	SILVER SERIGRAPHED ESCUTCHEON <i>MASCHERINA SERIGRAFATA ARGENTO</i>
	30		0347.015	ADHESIVE FOR PACKAGING <i>ADHESIVE FOR PACKAGING</i>

Model Machine

MACSAE055

SAECO ROYAL PROFESSIONAL



31



128310404

МЕТАЛЕВЕ УБЧАСТЕ КОЛІЩАТКО UNI 8842 A4
WASHER UNI 8842 A4 BURNISHED



32



20007052

SPARES KIT GEARS FOR RATIOMOTOR RYL
SPARES KIT GEARS FOR RATIOMOTOR RYL

Model Machine

MACSAE055

SAECO ROYAL PROFESSIONAL

MACSAE055.T.0005



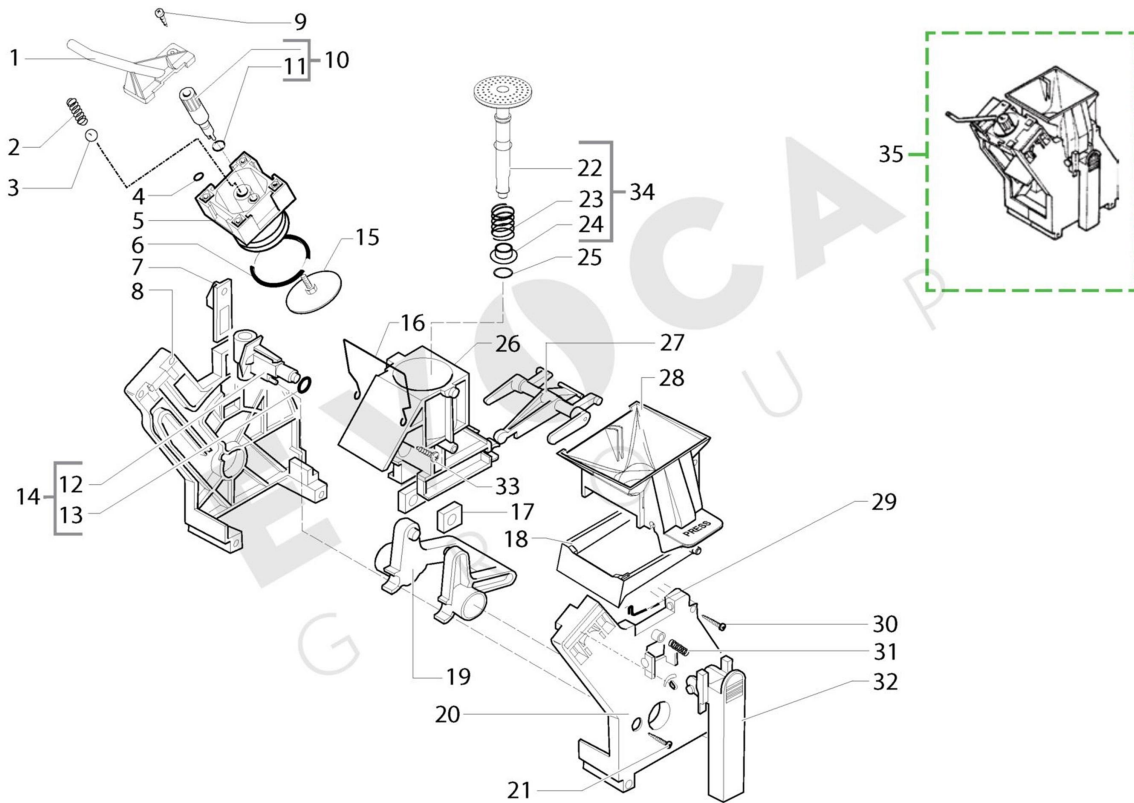























TAVOLA NR. 5 - ARTICOLO SAECO ROYAL PROFESSIONAL



Model Machine

MACSAE055





























SAECO ROYAL PROFESSIONAL

Web	Pos.	Foto	Item - Replace by	Description
				<i>Press - CTRL + CLICK go to item in a new window Натисніть - Ctrl + права кнопка миші щоб відкрити запчастину в новому вікні</i>
	1		11003789	BLACK COFF.OUTLET SLEEVE BREWUNIT ROYAL <i>BLACK COFF.OUTLET SLEEVE BREW UNIT ROYAL,AULIKA MAGIC SAECO</i>
	2		9161.222	SS.CONICAL SPRING <i>MOLLA CONICA</i>
	3		421944034451	BOROSILICATE SPHERE D.5 MM <i>BOROSILICATE SPHERE D.5</i>
	4		11021334	BLK COUNTERPISTON SEAL DE=11 DI=8 SP=1,4 <i>BLK COUNTERPISTON SEAL DE=11 DI=8 SP=1,4</i>
	5		11003796	BLACK BREW UNIT COUNTERPISTONM5000 <i>BLACK BREW UNIT COUNTERPISTON M5000</i>
	6		NM01.044	OR ORM 0320-40 SILICONE PTFE/FDA <i>OR ORM 0320-40 SILICONE PTFE</i>
	7		11004114	BLACK BREW UNIT COUPLING PLATE <i>BLACK BREW UNIT COUPLING PLATE</i>
	8		11003792	BLACK BREW UNIT REAR PLATE M5000 <i>BLACK BREW UNIT REAR PLATE M5000</i>
	9		U140.019	SCREW TCB TORX 10 3X16 PLAST SS <i>PANELVIT TCB 3,0X16 DIN 7505</i>
	10		227470150	PIN BLACK ASS.FOR PERCOLATOR <i>PIN BLACK ASS.FOR PERCOLATOR</i>
	11		NM02.006	OR R5 TERMOIL <i>OR R5 EPDM</i>
	12		9161.064.050	BLACK WATER INLET SLEEVE BREWUNIT ROYAL <i>BLACK WATER INLET SLEEVE BREW UNIT ROYAL</i>
	13		NM02.007	OR 2025 IN TERMOIL <i>OR 2025 TERMOIL</i>

Model Machine

MACSAE055















SAECO ROYAL PROFESSIONAL

	14		20000440	BLACK WATER INLET SLEEVE BREWUNIT ASSY. <i>BLACK WATER INLET SLEEVE BREW UNIT ASSY.</i>
	15		9160.075	PERCOLATOR DE=35,8 ELFO ASSY. <i>PERCOLATOR DE=35,8 ELFO ASSY.</i>
	16		11001556	SS BREW UNIT SPRING H=49 SMART <i>SS BREW UNIT SPRING H=49 SMART</i>
	17		9161.094.050	BLACK BREW UNIT DRILLED BLOCK <i>BLACK BREW UNIT DRILLED BLOCK</i>
	18		11004161	BLACK SCRAPER FOR BREW UNIT M5000 <i>BLACK SCRAPER FOR BREW UNIT M5000</i>
	19		9161.066.050	BLACK BREW UNIT ELBOW SHAFT M5000 <i>BLACK BREW UNIT ELBOW SHAFT M5000</i>
	20	 ПІД ЗАМОВЛЕННЯ	11003793	BLACK BREW UNIT FRONT PLATE M5000 <i>BLACK BREW UNIT FRONT PLATE M5000</i>
	21		12000550	CAMOPI3 TCB TORX 10 3X25 PLAST.SS <i>SCREW TCB TORX 10 3X25 PLAST.SS</i>
	22	 ПІД ЗАМОВЛЕННЯ	11003077	BLK BREW UNIT INTEGRAL PISTON8GR.ASSY. <i>BLK BREW UNIT INTEGRAL PISTON 8GR.ASSY.</i>
	23		9161.198	SS.8GR.BREW UNIT PISTON SPRING <i>SS.8GR.BREW UNIT PISTON SPRING</i>
	24		9161.191	WHITE 8GR.-12GR.BREW UNIT PISTON BUSH <i>BOCCOLA X PISTONE NEUTRO</i>
	25		NM02.018	OR ORM 0090-25 TERMOIL <i>OR ORM 0090-25 TERMOIL</i>
	26		11003075	BLACK COFFEE CONTAINER BREW UNIT P124 <i>BLACK COFFEE CONTAINER BREW UNIT P124</i>
	27		11003078	BLACK CONNECTING ROD BREW UNIT 8GR. <i>BLACK CONNECTING ROD BREW UNIT 8GR.</i>

Model Machine

MACSAE055

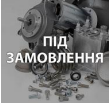
SAECO ROYAL PROFESSIONAL

	28		11003795	BLACK HOPPER COFF.BREW UNIT S/SCR.M5000 <i>BLACK HOPPER COFF.BREW UNIT S/SCR.M5000</i>
	29		9161.046	ПРУЖИНА ВОРОНКИ ЗАВАРОЧНОГО БЛОКА ДЛЯ КОФЕМАШИН PHILIPS ... <i>MOLLA X RASATORE GRUPPO</i>
	30		12000897	SCREW TCB TORX 10 3,5X20 PLAST.SS <i>SCREW TCB TORX 10 3,5X20 PLAST.SS</i>
	31		9161.045	SS BREW UNIT HANDGRIP SPRING M5000 <i>MOLLA X IMPUGNATURA GRUPPO</i>
	32		11003791	BLACK BREW UNIT HANDGRIP M5000 <i>BLACK BREW UNIT HANDGRIP M5000</i>
	33		129912521	SCREW TCBR TORX 10 3,5X14 PLAST.SS <i>SCREW TCBR TORX 10 3,5X14 PLAST.SS</i>
	34		11023086	BLK 8GR.BREW UNIT NTEGR.PISTONGEN.ASSY. <i>BLK 8GR.BREW UNIT NTEGR.PISTON GEN.ASSY.</i>
	35		11003800	BLACK BREW UNIT <i>BLACK BREW UNIT MAGIC/ROYAL</i>