

Model Machine

MACSAE019

SAECO ROYAL OFFICE (0368.00B.77C)

MACSAE019.T.0001



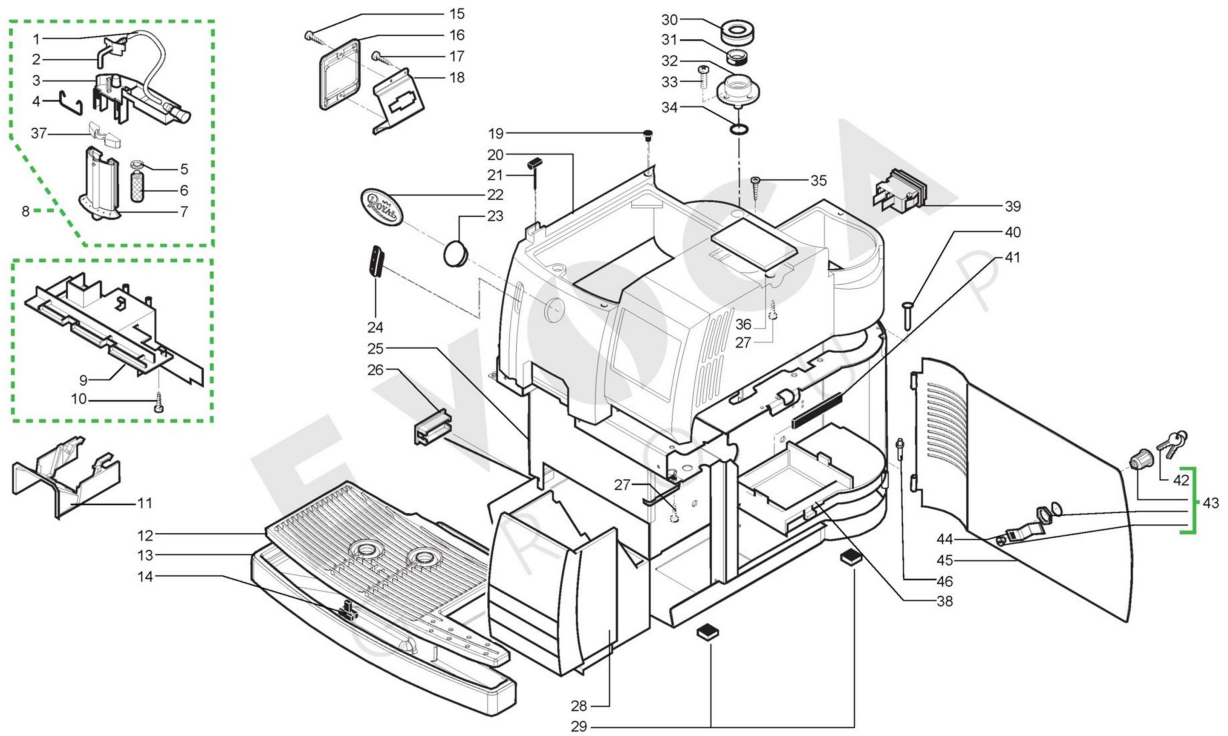









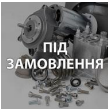

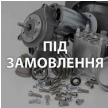









TAVOLA NR. 1 - ARTICOLO SAECO ROYAL OFFICE (0368.00B.77C)



Model Machine

MACSAE019

























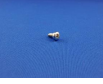

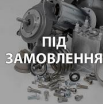
SAECO ROYAL OFFICE (0368.00B.77C)

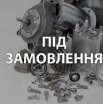
Web	Pos.	Foto	Item - Replace by	Description
				<i>Press - CTRL + CLICK go to item in a new window Натисніть - Ctrl + права кнопка миші щоб відкрити запчастину в новому вікні</i>
	1		9972.027	SILICONE TUBE 5X8 L. 85MM <i>SILICONE TUBE BROWN 5X8 L. 85 MM</i>
	2		11003705	CONNECTOR 90° DISPENSER BROWN <i>CONNECTOR 90° DISPENSER BROWN</i>
	3		0327.010.050	FIXED CASING DISPENSER BLACK <i>FIXED CASING DISPENSER BLACK</i>
	4		0327.037	SPRING FOR DISPENSER <i>SPRING FOR DISPENSER</i>
	5		0301.052	SEAL FOR DISPENSER SCREW <i>SEAL FOR DISPENSER SCREW</i>
	6		0301.050	SCREW M3 FOR DISPENSER <i>VITE M3 X EROGATORE</i>
	7		0333.050.760	MOBILE DISPENSER ASS. <i>ASS.EROGATORE MOBILE</i>
	8		0333.A03.760	DISPENSER ASS. OFFICE <i>DISPENSER ASS. OFFICE</i>
	9		0301.033.150	TANK CASING GREY <i>TANK CASING GREY</i>
	10		129670202	TCB PANELVIT SCREW 3,5X16 TESTA D=8 ZNP <i>TCB PANELVIT SCREW 3,5X16 TESTA D=8 ZNP</i>
	11		0312.009.770	DISPENSER LID SILVER <i>COPERCHIO EROGATORE ARGENTO</i>
	11		0312.009.850	DISPENSER LID <i>COPERCHIO EROGATORE BLU</i>

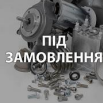
Model Machine

MACSAE019













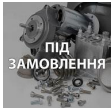

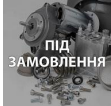

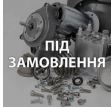

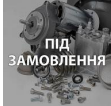







SAECO ROYAL OFFICE (0368.00B.77C)

	12		0333.005.770	PAINTED GRATE <i>GRIGLIA VERNICIATA</i>
	13		0333.006.770	DRIP TRAY SILVER <i>VASCA RACCOGLIGOCCE SILVER DRIP TRAY SILVER</i>
	13		0333.006.850	DRIP TRAY <i>VASCA RACCOGLIGOCCE</i>
	14		145500211	RED FLOAT FOR DRIP TRAY SEB GRANCAF. <i>GALLEGGIANTE ROSSO X SEB GRANCAFFE'</i>
	15	 ПІД ЗАМОВЛЕННЯ	U143.015	PANELVIT TCB 3,0X12 TORX BLACK <i>PANELVIT TCB 3,0X12 TORX BLACK</i>
	16	 ПІД ЗАМОВЛЕННЯ	0333.026.770	CONNECTOR LID SILVER <i>CONNECTOR LID SILVER</i>
	16	 ПІД ЗАМОВЛЕННЯ	0333.026.850	CONNECTOR LID <i>CONNECTOR LID</i>
	17		129511903	SCREW TCB 2,9X6,4 DIN 7981 BZNICK <i>SCREW TCB 2,9X6,4 DIN 7981 BZ NICK</i>
	18	 ПІД ЗАМОВЛЕННЯ	0333.025	CONNECTOR SUPPORT <i>CONNECTOR SUPPORT</i>
	19	 ПІД ЗАМОВЛЕННЯ	0333.044.280	CAP <i>CAP</i>
	20	 ПІД ЗАМОВЛЕННЯ	0333.047.770	CASING LID ROYAL SILVER S/S.OFFICE <i>CASING LID ROYAL SILVER S/S.OFFICE</i>
	20		0333.062.770	LID UL SAECO ROYAL OFFICE SILVER <i>LID UL SAECO ROYAL OFFICE SILVER</i>
	21		0333.043.280	CLOSURE RUBBER <i>CLOSURE RUBBER</i>
	22	 ПІД ЗАМОВЛЕННЯ	0333.951	OVAL DATA PLATE ROYAL <i>OVAL DATA PLATE ROYAL</i>

Model Machine

MACSAE019



























SAECO ROYAL OFFICE (0368.00B.77C)

	23		0333.022.850	CAP FOR FAUCET HOLE <i>CAP FOR FAUCET HOLE</i>
	24		0333.021.280	RUBBER FOR STEAM TUBE HOLE <i>RUBBER FOR STEAM TUBE HOLE</i>
	25		0333.023.660	TF/SILVER CASING OFFICE REMOVAL GROUNDS <i>TF/SILVER CASING OFFICE REMOVAL GROUNDS</i>
	25		0333.023.840	BLUE CASING OFFICE REMOVAL GROUNDS <i>BLUE CASING OFFICE REMOVAL GROUNDS</i>
	25		11025917	TF/SILVER CASING OFFICE REMOV.GROUNDS V2 <i>TF/SILVER CASING OFFICE REMOV.GROUNDS V2</i>
	26		0313.006.050	SWITCH COVER BLACK <i>SWITCH COVER BLACK</i>
	27		U110.005	SCREW AUT.TCB 3,9X9,5 DIN 7981F <i>VITE AUT.TCB 3,9X9,5 DIN 798</i>
	28		0312.032.770	SILVER DUMP BOX <i>DUMP BOX PAINTED SILVER</i>
	28		0312.032.850	BLUE DUMP BOX <i>DUMP BOX BLUE</i>
	28		11025952	SILVER DUMP BOX V2 <i>SILVER DUMP BOX V2</i>
	29		147623150	BLACK SQUARE ADHESIVE FOOT 5023 <i>BLACK SQUARE ADHESIVE FOOT 5023</i>
	30		0701.031.150	GREY WATER VALVE GACO DIM 14 SEAL COVER <i>SEAL COVER GREY</i>
	31		145842900	NBR WATER CONT.VALVE GACO DIM14 SEAL <i>NBR WATER CONT.VALVE GACO DIM14 SEAL</i>
	32		0701.014.150	GREY WATER VALVE GACO DIM 14 SEAL CONT. <i>GREY WATER VALVE GACO DIM 14 SEAL CONT.</i>

Model Machine

MACSAE019

SAECO ROYAL OFFICE (0368.00B.77C)

	33		129532521	SCREW TSP2,9X9,5 DIN 7982 SS SCREW TSP2,9X9,5 DIN 7982 SS
	34		140320461	OR ORM 0080-20 TERMOIL OR ORM 0080-20 IN TERMOIL
	35		U143.007	SCREW TORX TCB 2,9X19 SS BUR VITE TORX TCB 2,9X19 INO
	36	 ПІД ЗАМОВЛЕННЯ	0312.008.770	DOSER LID DOSER LID
	36	 ПІД ЗАМОВЛЕННЯ	0312.031.770	DOSER LID UL SILVER DOSER LID UL SILVER
	37	 ПІД ЗАМОВЛЕННЯ	0368.005.050	TAPPO X EROGATORE SIL 70 TAPPO X EROGATORE SIL 70
	38		0301.041.150	GREY BREW UNIT SUPPORT PLATE ROYAL PIASTRA SUPPORTO GRUPPO GRIGIO
	39	 ПІД ЗАМОВЛЕННЯ	12000641	MOLVENO WATERPROOF GW ASSEMBLY SWITCH MOLVENO WATERPROOF GW ASSEMBLY SWITCH
	40		0301.019	NIK/BRASS PIN FOR DOOR SUPERAUT. NIK/BRASS PIN FOR DOOR SUPERAUT.
	41		9161.140	SEAL FOR UNIT PLATE GUARNIZIONE X PIASTRA GRUPPO
	42		0701.R29	KEY KA 35 CHIAVE VIRO KA 35 X SERRAT.S
	43		NV02.095	DOOR LOCK VIRO DOOR LOCK VIRO
	44	 ПІД ЗАМОВЛЕННЯ	0333.037	LOCK BRACKET LOCK BRACKET

Model Machine

MACSAE019

SAECO ROYAL OFFICE (0368.00B.77C)



45

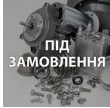

0333.036.660

DOOR ASS. OFFICE SILVER TF
DOOR ASS. OFFICE SILVER TF



45

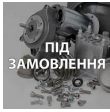

0333.036.840

DOOR ASS. ROYAL OFFICE BLUE
DOOR ASS. ROYAL OFFICE BLUE



46



0301.020

NIK/BRASS PIN FOR DOOR SUPERAUT.
NIK/BRASS PIN FOR DOOR SUPERAUT.

Model Machine

MACSAE019

SAECO ROYAL OFFICE (0368.00B.77C)

MACSAE019.T.0002



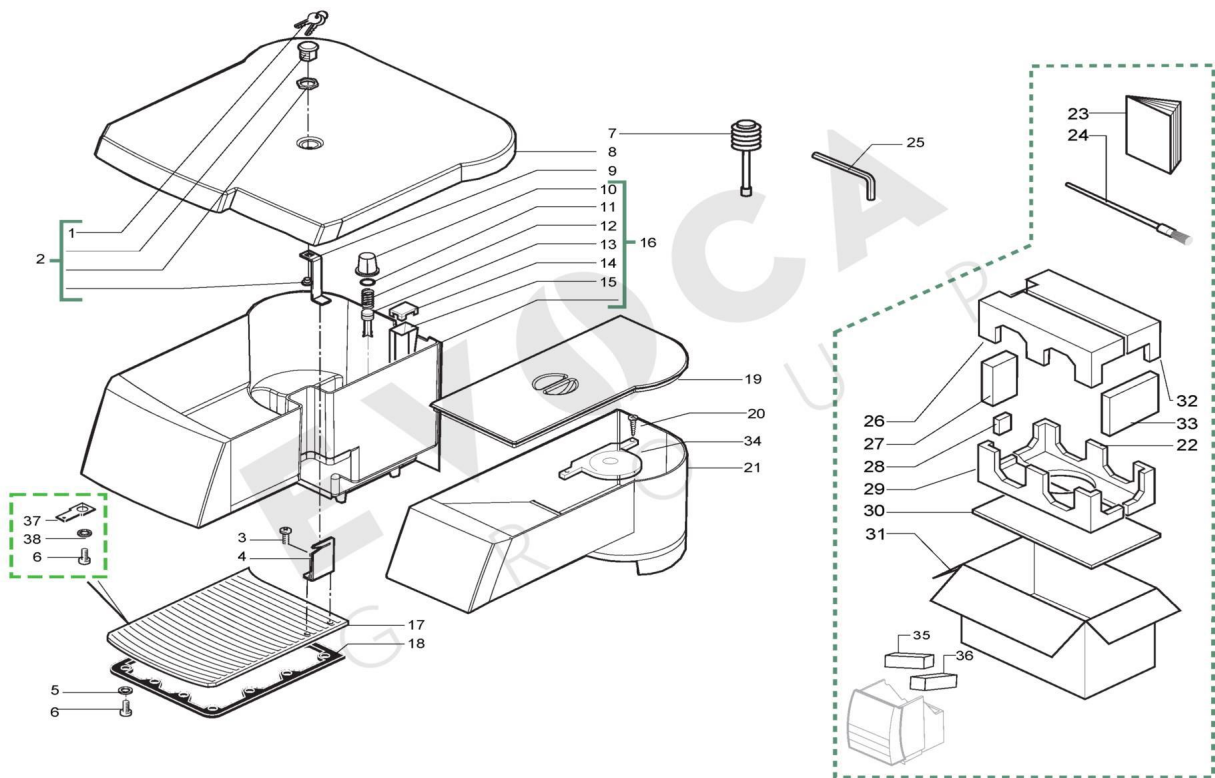





















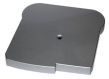

TAVOLA NR. 2 - ARTICOLO SAECO ROYAL OFFICE (0368.00B.77C)



Model Machine

MACSAE019











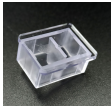





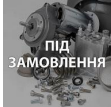

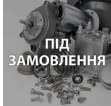

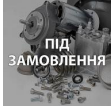



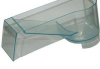

SAECO ROYAL OFFICE (0368.00B.77C)

Web	Pos.	Foto	Item - Replace by	Description
				<i>Press - CTRL + CLICK go to item in a new window Натисніть - Ctrl + права кнопка миші щоб відкрити запчастину в новому вікні</i>
	1		0701.R29	KEY KA 35 CHIAVE VIRO KA 35 X SERRAT.S
	2		NV02.095	DOOR LOCK VIRO DOOR LOCK VIRO
	3		U127.003	SCREW TAPT.TCB M4,0X6 DIN 7500C SCREW TAPT.TCB M4,0X6 DIN 7500C
	4		0333.016	BRACKET COUPLING SUPPORT SQUADRETTA AGGANCIO STAFFA
	5		U201.005	PLAIN WASHER 4,3X12 DIN 7349 GAL PLAIN WASHER 4,3X12 DIN 7349 GAL
	6		129573402	SCREW TAPT M4X10 DIN 7985 GALV SCREW TAPT M4X10 DIN 7985 GALV
	7		147700200	LOADING PUMP DIAMETER 17 MM LOADING PUMP DIAMETER 17 MM
	8		0333.003.770	MAIN LID MAIN LID
	9		0333.015	COUPLING BRACKET STAFFA DI AGGANCIO
	10		224640200	БІЛИЙ ПЛАСТИКОВИЙ ФІЛЬТР У КОНТЕЙНЕР ВОДИ SAECO 996530029115 EXTERNAL FILTER FOR WATER CONTAINER ASSY
	11		NM01.032	ПРОКЛАДКА O-RING ORM 0060-30 ДЛЯ КАВОМАШИНИ ЧЕРВОНА SAECO... OR ORM 0060-30 SILICONE ROSSA
	12		9161.110	PISTON SPRING FOR SUPERAUT. MOLLA X PISTONCINO SUPERAUTO
	13		147660562	GREY PISTON FOR WATER CONTAINER VALVE GREY PISTON FOR WATER CONTAINER VALVE

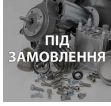
Model Machine

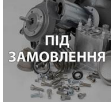
MACSAE019

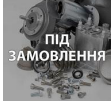
SAECO ROYAL OFFICE (0368.00B.77C)

	14		9161.050.230	NAT/TRANSP.FLOATING SPACE PLUGMAGIC <i>TAPPO X GALLEGGIANTE SUPERAUTOM.</i>
	15		9161.112.150	GREY LEVEL FLOAT <i>GALLEGGIANTE DI LIVELLO GRIGIO</i>
	16		0333.046.230	WATER TANK ASS. <i>ASS.SERBATOIO ACQUA</i>
	16	 ПІД ЗАМОВЛЕННЯ	0333.A12.230	TRANSPAR.WATER TANK ASS.ROYALOFFICE UL <i>TRANSPAR.WATER TANK ASS.ROYAL OFFICE UL</i>
	17	 ПІД ЗАМОВЛЕННЯ	0333.051.050	CUP WARMER PLATE OFFICE BLACK <i>PIASTRA SCALDATAZZE OFFICE NERO</i>
	18	 ПІД ЗАМОВЛЕННЯ	0312.014	CUPWARMER SEAL <i>CUPWARMER SEAL</i>
	19		0333.004.050	COFFEE CONT.LID <i>COPERCHIO CONTENITORE CAFFE'</i>
	20		129670202	TCB PANELVIT SCREW 3,5X16 TESTA D=8 ZNP <i>TCB PANELVIT SCREW 3,5X16 TESTA D=8 ZNP</i>
	21		0333.002.230	COFFEE CONTAINER <i>CONTENITORE CAFFE'</i>
	21		0333.066.230	TRANSPARENT COFFEE CONTAINER UL <i>TRANSPARENT COFFEE CONTAINER UL</i>
	22	 ПІД ЗАМОВЛЕННЯ	0333.902	PS-E RIGHT LOWER INSERT <i>PS-E RIGHT LOWER INSERT</i>
	23	 ПІД ЗАМОВЛЕННЯ	0368.951	INSTR.BOOKLET OFFICE UP_GRADEI <i>INSTR.BOOKLET OFFICE UP_GRADE I</i>
	23	 ПІД ЗАМОВЛЕННЯ	0368.952	INSTR.BOOKLET OFFICE UP_GRADED <i>INSTR.BOOKLET OFFICE UP_GRADE D</i>
	23	 ПІД ЗАМОВЛЕННЯ	0368.953	INSTR.BOOKLET OFFICE UP_GRADEF <i>INSTR.BOOKLET OFFICE UP_GRADE F</i>

Model Machine

MACSAE019











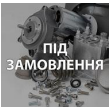

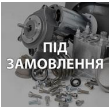

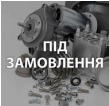



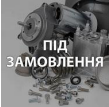



SAECO ROYAL OFFICE (0368.00B.77C)

	23		0368.954	INSTR.BOOKLET OFFICE UP_GRADEGB <i>INSTR.BOOKLET OFFICE UP_GRADE GB</i>
	23		0368.955	INSTR.BOOKLET OFFICE UP_GRADEE <i>INSTR.BOOKLET OFFICE UP_GRADE E</i>
	23		0368.956	INSTR.BOOKLET OFFICE UP_GRADENL <i>INSTR.BOOKLET OFFICE UP_GRADE NL</i>
	23		0368.957	INSTR.BOOKLET OFFICE UP_GRADEP <i>INSTR.BOOKLET OFFICE UP_GRADE P</i>
	23		0368.963	INSTR.BOOKLET OFFICE UP_GRADEI <i>INSTR.BOOKLET OFFICE UP_GRADE I</i>
	23		0368.964	INSTR.BOOKLET OFFICE UP_GRADED <i>INSTR.BOOKLET OFFICE UP_GRADE D</i>
	23		0368.965	INSTR.BOOKLET OFFICE UP_GRADEF <i>INSTR.BOOKLET OFFICE UP_GRADE F</i>
	23		0368.966	INSTR.BOOKLET OFFICE UP_GRADEGB <i>INSTR.BOOKLET OFFICE UP_GRADE GB</i>
	23		0368.967	INSTR.BOOKLET OFFICE UP_GRADEE <i>INSTR.BOOKLET OFFICE UP_GRADE E</i>
	23		0368.968	INSTR.BOOKLET OFFICE UP_GRADENL <i>INSTR.BOOKLET OFFICE UP_GRADE NL</i>
	23		0368.969	INSTR.BOOKLET OFFICE UP_GRADEP <i>INSTR.BOOKLET OFFICE UP_GRADE P</i>
	25		NV99.055	ALLEN KEY 5 <i>ALLEN KEY 5</i>
	26		0333.903	PS-E LEFT UPPER INSERT <i>PS-E LEFT UPPER INSERT</i>

Model Machine

MACSAE019

SAECO ROYAL OFFICE (0368.00B.77C)

	27		0333.908	DRIP TRAY BOX <i>DRIP TRAY BOX</i>
	28		0333.905	SPACER <i>SPACER</i>
	29		0333.901	PS-E LEFT LOWER INSERT <i>PS-E LEFT LOWER INSERT</i>
	30		0333.909	ONDULATED CARDB.SHEET <i>ONDULATED CARDB.SHEET</i>
	31		0333.906	EXTERNAL BOX <i>EXTERNAL BOX</i>
	32		0333.904	PS-E RIGHT UPPER INSERT <i>PS-E RIGHT UPPER INSERT</i>
	33		0333.907	BOX MAIN LID <i>BOX MAIN LID</i>
	34		0312.028.230	PROTECTION FOR COFFEE CONTAINER <i>PROTECTION FOR COFFEE CONTAINER</i>
	35		13001335	PE INSERT145X50X50 FOR DUMP BOX V2 ROYAL <i>PE INSERT145X50X50 FOR DUMP BOX V2 ROYAL</i>
	36		13001336	PE INSERT115X50X50 FOR DUMP BOX V2 ROYAL <i>PE INSERT115X50X50 FOR DUMP BOX V2 ROYAL</i>
	37		NE15.003	MALE TONGUE PLAIN 6,3 D.5,2 <i>LINGUETTA MASCHIO PIANA 6,3 D.5,2</i>
	38		128310404	МЕТАЛЕВЕ УБЧАСТЕ КОЛІЩАТКО UNI 8842 A4 <i>WASHER UNI 8842 A4 BURNISHED</i>

Model Machine

MACSAE019

SAECO ROYAL OFFICE (0368.00B.77C)

MACSAE019.T.0003



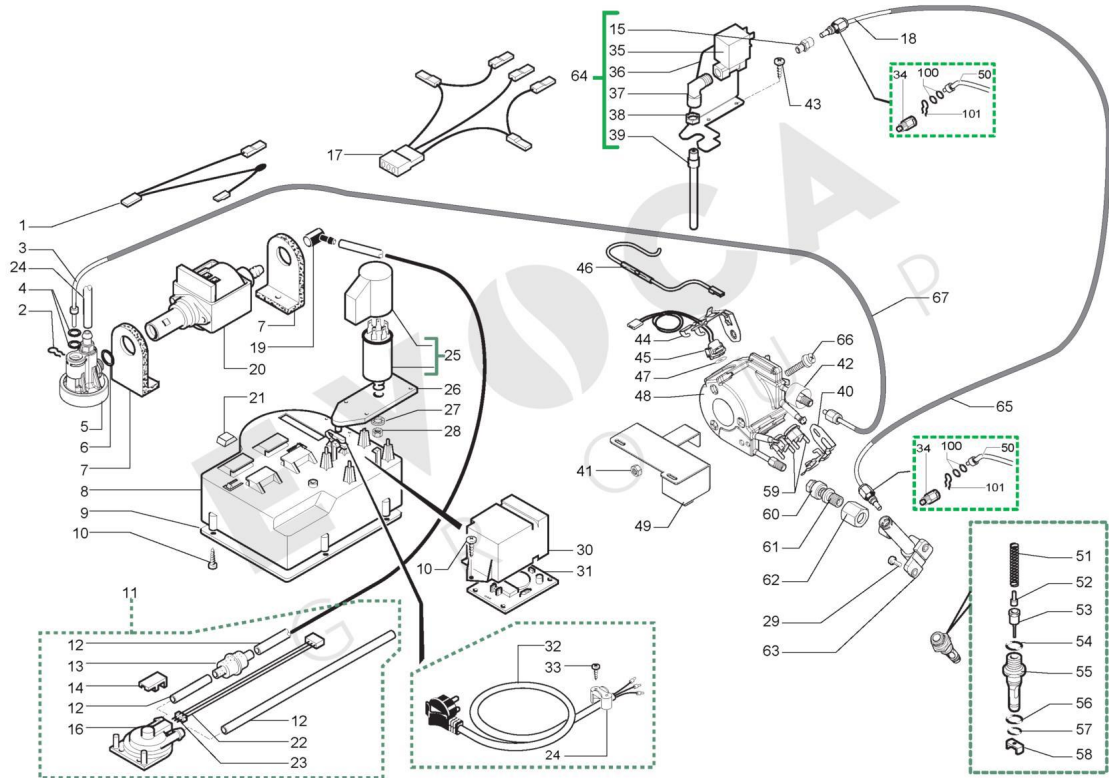









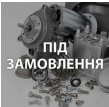

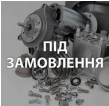











TAVOLA NR. 3 - ARTICOLO SAECO ROYAL OFFICE (0368.00B.77C)



Model Machine

MACSAE019











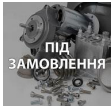











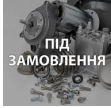



SAECO ROYAL OFFICE (0368.00B.77C)

Web	Pos.	Foto	Item - Replace by	Description
				<i>Press - CTRL + CLICK go to item in a new window Натисніть - Ctrl + права кнопка миші щоб відкрити запчастину в новому вікні</i>
	1		0335.801	HARNESS WITH PUMP KLIXON UL HARNESS WITH PUMP KLIXON UL
	1		0368.820	HARNESS WITH KLIXON PUMP HARNESS WITH KLIXON PUMP
	2		9011.144	SS FORK FOR TUBE D=4 FORCELLA X TUBO D.4
	3		227875400	CONNECTOR AS.TEFLON 2X4 L=330MM AS.RAC.TEFLON+DADO+PROT.2X4 L=330MM
	4		140328059	OR 2015 SILICONE PTFE/FDA OR 2015 SILICONE PTFE/FDA
	5		229452100	COMPENSATION AND SAFETY VALVE16BAR ASSY AS.VALV.DI COMPENS.E SICUREZ
	6		140321961	ПРОКЛАДКА O-RING ДЛЯ КАВОМАШИНИ SAECO 2031 TERMOIL OR 2031 IN TERMOIL
	7		149185850	ТРИМАЧ (ГУМОВИЙ)ПОМПИ ДЛЯ КАВОМАШИН SAECO MAGIC 4002012 (... SUPPORTO POMPA EATON MAGIC 4
	8		0301.056.150	POWER CABLE CONT. VDE GREY POWER CABLE CONT. VDE GREY
	8		0335.008.150	POWER SUPPLY CABLE GREY UL POWER SUPPLY CABLE GREY UL
	9		0301.055.150	LID FOR POWER CABLE CONT. GREY LID FOR POWER CABLE CONT. GREY
	10		129670202	TCB PANELVIT SCREW 3,5X16 TESTA D=8 ZNP TCB PANELVIT SCREW 3,5X16 TESTA D=8 ZNP
	11		0333.A08	TURBINE ASS. OFFICE ASS.TURBINA OFFICE

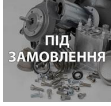
Model Machine

MACSAE019

















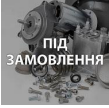





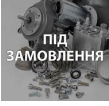

SAECO ROYAL OFFICE (0368.00B.77C)

	11		0333.A11	TURBINE ASS. OFFICE UL <i>TURBINE ASS. OFFICE UL</i>
	12		JS01.022	SILICONE TUBE 5X10 60SH IN ROLL <i>SILICONE TUBE 5X10 60SH IN ROLL</i>
	13		144650300	ФІЛЬТР ОЧИСТКИ ВОДИ ДЛЯ КАВОМАШИНИ SAECO NEW (NV99.001) (88... <i>ASPIRATION FILTER GAUZE NET 500 (NEW)</i>
	14		9161.018	BRACKET FOR TURBINE <i>BRACKET FOR TURBINE</i>
	15		11009009	TEA/BRASS CONNECTOR FOR TUBE TEFLON 4X2 <i>TEA/BRASS CONNECTOR FOR TUBE TEFLON 4X2</i>
	16		286473300	-M-VDE TURBINE WITH SENSOR KIT <i>KIT TURBINA VDE "M" C/SENS.M</i>
	17		0333.834	ASS.CONNETTORE SCHEDA INTERFACCIA <i>ASS.CONNETTORE SCHEDA INTERFACCIA</i>
	17		0333.835	ASS.CONNETTORE SCHEDA INTERFAC.UL <i>ASS.CONNETTORE SCHEDA INTERFAC.UL</i>
	18		9979.B40	TEFLON TUBE 4X2 L.250 OG-OG ASSY. <i>TEFLON ASS. TUBE 4X2 L.250 OG-OG</i>
	19		147920150	90° INLET PUMP CONNECTOR <i>RACCORDO A 90° IN SANTOPRENE</i>
	20		12000130	ULKA PUMP EP5/S GW 100V-50/60HZ <i>ULKA PUMP EP5/S GW 100V-50/60HZ</i>
	20		12000131	ULKA PUMP EP5/S 120V-60HZ <i>ULKA PUMP EP5/S 120V-60HZ</i>
	20		12000132	ULKA PUMP EP5/S GW 220V-50/60HZ <i>ULKA PUMP EP5/S GW 220V-50/60HZ</i>
	20		12000140	PUMP 230V-50HZ <i>ULKA PUMP EP5/S GW 230V-50HZ</i>

Model Machine

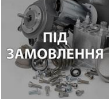
MACSAE019

















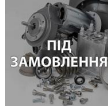



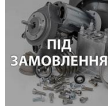

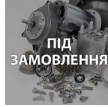

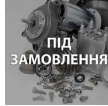

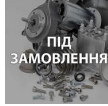
SAECO ROYAL OFFICE (0368.00B.77C)

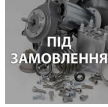
	21		147620400	BLACK SQUARE ADHESIVE FOOT SJ-5018 <i>BLACK SQUARE ADHESIVE FOOT SJ-5018</i>
	22		0317.830	CONN. ASS. 3 POLE TURBINE PROFES.U <i>CONN. ASS. 3 POLE TURBINE PROFES.U</i>
	22		0368.817	3 POLE CONNECTOR <i>3 POLE CONNECTOR</i>
	24		9991.039	CABLE RETAINER UL <i>CABLE RETAINER UL</i>
	25		0301.A12.00A	CAP + ANTIDISTURB FILTER OCS 230V ASSY. <i>CAP + ANTIDISTURB FILTER OCS 230V ASSY.</i>
	26		0327.035.150	ANTIDISTURB FILTER SUPPORT <i>ANTIDISTURB FILTER SUPPORT</i>
	27		U208.009	TOOTHED WASHER 8,4X15 UNI 3703 <i>TOOTHED WASHER 8,4X15 UNI 3703</i>
	28		U302.007	NUT HEXAGONAL M8 UNI 5588 <i>NUT HEXAGONAL M8 UNI 5588</i>
	29		U043.021	SCREW TCBC M5,0X8 UNI 7687 GALV. <i>VITE TCBC M5,0X8 UNI 7687 ZNP</i>
	30		9161.126.150	COVER FOR FILTER CARD GREY <i>COVER FOR FILTER CARD GREY</i>
	30		9161.336.150	COVER FOR FILTER CARD GREY UL <i>COVER FOR FILTER CARD GREY UL</i>
	31		0301.828.00F	FILTRATION CARD SUPERAUTOM. 120V <i>SCHEDA FILTRAGGIO SUPERAUTOM</i>
	32		17800032	BLACK POWER CABLE BRAZIL L=1770 <i>BLACK POWER CABLE BRAZIL L=1770</i>

Model Machine

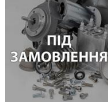
MACSAE019





























SAECO ROYAL OFFICE (0368.00B.77C)

	32		NE01.061	BLACK POWER CABLE SCHUKO L=1500 <i>BLACK CABLE SCHUKO H05 1 MM</i>
	32		NE01.062	POWER CABLE CH H05 GREY 1 MM <i>CAVO AL.CH H05 GRIGIO 1 MM</i>
	32		NE01.116	CABLE USA 3P BLACK 1 MM <i>CABLE USA 3P BLACK 1 MM</i>
	33		U140.009	PANELVIT TCB 3,0X16 DIN 7505 BGAL <i>PANELVIT TCB 3,0X16 DIN 7505 B GAL</i>
	34		9011.152	BRASS 1/8" CONNECTOR FOR TUBED=4 <i>RACCORDO X TUBO D.4 1/8</i>
	35		11008569	SOLEN.VALVE 15VA 2 WAY 1/8" FEM.TEA 230V <i>SOLEN.VALVE 15VA 2 WAY 1/8 FEM.TEA 230V</i>
	35		11008570	SOLEN.VALVE 21VA 2 WAY 1/8" FEM.TEA 120V <i>SOLEN.VALVE 21VA 2 WAY 1/8" FEM.TEA 120V</i>
	35		11008575	SOLEN.VALVE 15VA 2W.1/8"FEM.DN3 TEA 100V <i>SOLEN.VALVE 15VA 2W.1/8"FEM.DN3 TEA 100V</i>
	36		0333.024	SHEET METAL PROTECTION <i>SHEET METAL PROTECTION</i>
	37		NR07.021	STANDARD CONN. L MF 1/8 NICK <i>STANDARD CONN. L MF 1/8 NICK</i>
	38		U303.002	NUT HEXAGONAL M12X1,25UNI 5589 <i>NUT HEXAGONAL M12X1,25UNI 5589</i>
	39		0333.028	WATER DISPENSING TUBE <i>WATER DISPENSING TUBE</i>
	40		126838117	2 THERMOSTATS FIXING SPRING <i>MOLLA FERMA 2 TERMOSTATI</i>
	41		123453902	SELF-LOCKI.NUT M5X0,8 DIN 980CLA.8 <i>DADO METALBLOC M5X0,8 DIN 98</i>

Model Machine

MACSAE019

























SAECO ROYAL OFFICE (0368.00B.77C)

	42		147756562	BLK PROTECTION FOR FOLK SPRINGTUBE D=4 <i>BLK PROTECTION FOR FOLK SPRING TUBE D=4</i>
	43		U110.013	БОЛТ МЕТАЛЕВИЙ 3,9X6,5 DIN 7981 F <i>SCREW AUT.TCB 3,9X6,5 DIN 7981 F</i>
	44		126838017	SENSOR FIXING SPRING <i>SENSOR FIXING SPRING</i>
	45		288582300	ТЕМПЕРАТУРНИЙ ДАТЧИК З ЖОВТИМИ ПРОВОДАМИ SAECO <i>SENSOR ELECT.BOARD WITH CONNECTOR ASSY.</i>
	46		0333.831	CONNECTOR 2 POLE OFFICE UL ASSY. <i>CONNECTOR 2 POLE OFFICE UL ASSY.</i>
	46		11028403	CONNECTOR <i>CONNECTOR</i>
	47		145951600	ELECTRIC INSULATING D=16 SP=0,4 <i>ELECTRIC INSULATING DISK D=16</i>
	48		282058854	V2 TUB.BOILER W/ADDIT.RESIST.1100W 100V <i>V2 TUB.BOILER W/ADDIT.RESIST.1100W 100V</i>
	48		282058855	V2 TUB.BOILER W/ADDIT.RESIST.1100W 120V <i>V2 TUB.BOILER W/ADDIT.RESIST.1100W 120V</i>
	48		282058858	V2 TUB.BOILER W/ADDIT.RESIST.1100W 230V <i>V2 TUB.BOILER W/ADDIT.RESIST.1100W 230V</i>
	49		0333.080	BRACKET FOR BOILER OFFICE <i>SQUADRETTA X CALDAIA OFFICE</i>
	50		9979.A55	TEFLON TUBE ASS. 4X2 L.260 7-7 <i>ASS.TUBO TEFLON 4X2 L.260 7-</i>
	51		9011.132	SS SPRING FOR PIN <i>MOLLA X SPILLO</i>
	52		11009013	TEA/BRASS PIN FOR PISTON L=10 <i>TEA/BRASS PIN FOR PISTON L=10</i>

Model Machine

MACSAE019

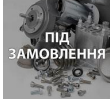





SAECO ROYAL OFFICE (0368.00B.77C)

	53		11009019	TEA/BRASS PISTON L=20,9 ASSY. <i>TEA/BRASS PISTON L=20,9 ASSY.</i>
	54		140320459	OR ORM 0080-20 SILICONE PTFE/FDA <i>OR ORM 0080-20 IN SILICONE PTFE/FDA</i>
	55		9011.100	PEG FOR VALVE IN PLASTIC <i>PEG FOR VALVE IN PLASTIC</i>
	56		NM01.035	OR ORM 0090-20 SILICONE <i>OR ORM 0090-20 SILICONE</i>
	57	 ПІД ЗАМОВЛЕННЯ	NM01.057	OR ORM 0050-20 IN SILICONE <i>OR ORM 0050-20 IN SILICONE</i>
	58		11005099	NATURAL CURSOR V2 FOR BOILER P119 <i>NATURAL CURSOR V2 FOR BOILER P119</i>
	59		189428200	THERMOSTAT 175° 1NT-08L-3794 <i>THERMOSTAT 175° 1NT-08L-3794</i>
	60		0333.076	BOILER CONNECTOR OFFICE <i>RACCORDO X CALDAIA OFFICE</i>
	61		0333.078	CONN.ADAPTER <i>RACCORDO ADATTATORE</i>
	62		0333.077	NUT <i>DADO</i>
	63		0333.079	SUPPORTO PERNO <i>SUPPORTO PERNO</i>
	64	 ПІД ЗАМОВЛЕННЯ	0333.A04.00A	WATER DISPENSING VALVE ASS. <i>WATER DISPENSING VALVE ASS.</i>
	64	 ПІД ЗАМОВЛЕННЯ	0333.A04.00F	WATER DISPENSING VALVE ASS. 120V <i>WATER DISPENSING VALVE ASS. 120V</i>

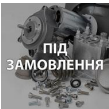
Model Machine

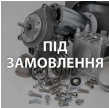
MACSAE019

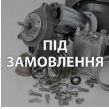
SAECO ROYAL OFFICE (0368.00B.77C)

	64	 ПІД ЗАМОВЛЕННЯ	0333.A04.00R	WATER DISPENSING VALVE ASS. 100V <i>WATER DISPENSING VALVE ASS. 100V</i>
	64	 ПІД ЗАМОВЛЕННЯ	0368.A14.00A	WATER DISPENSING VALVE ASS. <i>WATER DISPENSING VALVE ASS.</i>
	64	 ПІД ЗАМОВЛЕННЯ	0368.A14.00F	WATER DISPENSING VALVE ASS. <i>WATER DISPENSING VALVE ASS.</i>
	64	 ПІД ЗАМОВЛЕННЯ	0368.A14.00R	WATER DISPENSING VALVE ASS. <i>WATER DISPENSING VALVE ASS.</i>
	65		9972.150	BLACK SILICONE TUBE 7,5X9,3 L=210 MM <i>TUBO SILICONE NERO 7,5X9,3 L.210 MM</i>
	66		129932202	ROUND HEAD SCREW 10.9 M5X20 GALV <i>ROUND HEAD SCREW 10.9 M5X20 GALV</i>
	67		229431200	BLACK SILICONE TUBE 7,5X9,3 L=250 MM <i>BLACK SILICONE TUBE 7,5X9,3 L=250 MM</i>

Model Machine

MACSAE019

SAECO ROYAL OFFICE (0368.00B.77C)

MACSAE019.T.0004



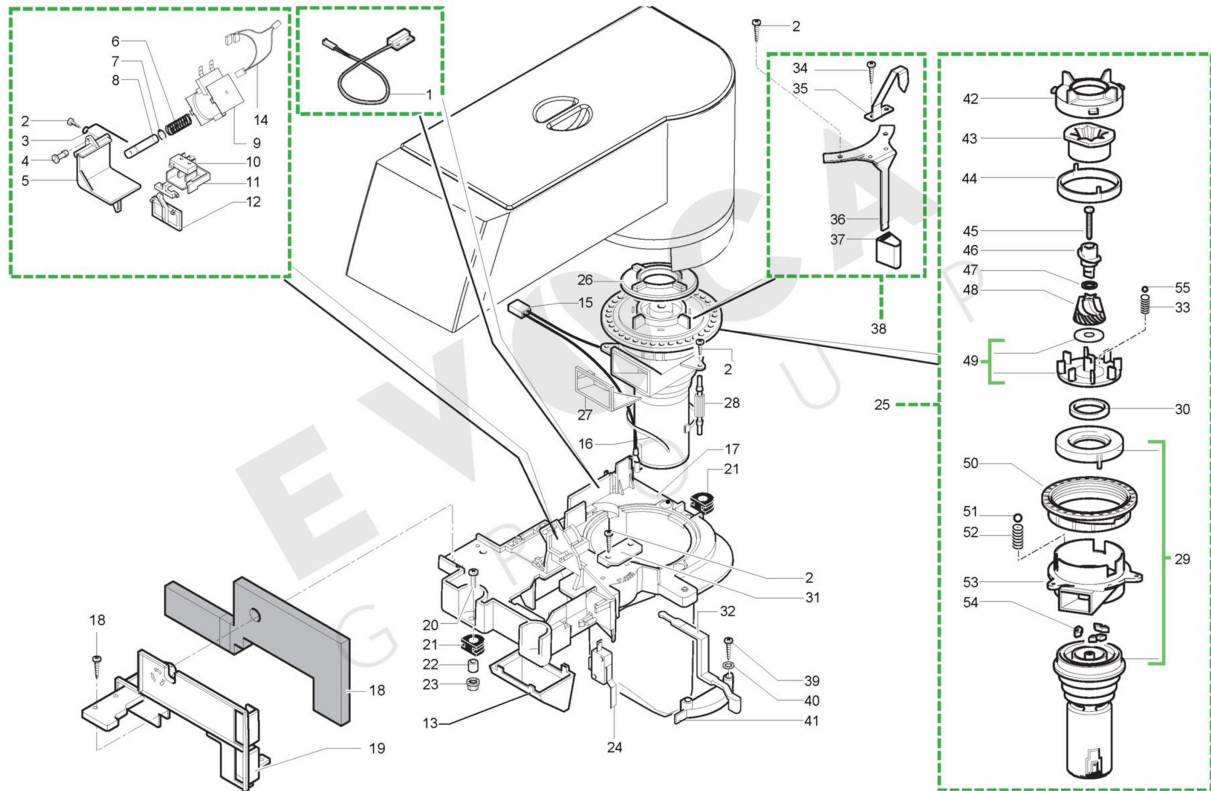























TAVOLA NR. 4 - ARTICOLO SAECO ROYAL OFFICE (0368.00B.77C)



Model Machine

MACSAE019

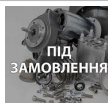

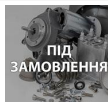















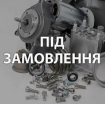

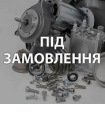





SAECO ROYAL OFFICE (0368.00B.77C)

Web	Pos.	Foto	Item - Replace by	Description
				<i>Press - CTRL + CLICK go to item in a new window Натисніть - Ctrl + права кнопка миші щоб відкрити запчастину в новому вікні</i>
	1		0301.811	CONNECTOR 2 POLES LEVEL ASSY. SENSORE ASS.2 POLI LIVELLO
	1		0317.829	CONNECTOR 2 POLES LEVEL UL ASSY. CONNECTOR 2 POLES LEVEL UL ASSY.
	1		0368.802	CONNET.ASS. 2 POLI MACINACAFFE'UL CONNET.ASS. 2 POLI MACINACAFFE'UL
	1		0368.818	2 POLE CONNECTOR CONNETTORE ASS. 2 POLI LIVELLO
	2		U140.004	PANELVIT TCB 3,0X12 DIN 7505 BGAL PANELVIT TCB 3,0X12 DIN 7505 B ZNP
	3		9161.048	STEEL GROUND COF.DOSER SCRAPERROD ASTA RASATORE
	4		9161.076.150	GREY GROUND COF.DOSER DOOR PIN PERNO SPORTELLO DOSATORE GRIGIO
	5		9161.074.150	GREY GROUND COFFE DOSER DOOR SPORTELLO DOSATORE GRIGIO
	6		126764818	ПРУЖИНА ЕЛЕКТРОМАГНІТНОГО ДОЗАТОРА ЗЕРНА MAGIC SAECO 916... SPRING ELECTROM.BEAN DOSER MAGIC
	7		U701.003	SNAP RING 7 UNI 7434 ANELLO ELASTICO 7 UNI 7434
	8		9161.041	STEEL GROUND COF.DOSER ELECTROMAGN.CORE NUCLEO ELETTRMAGNETE DOSATORE
	9		9129.A07.00F	COFFEE DOSER COIL ASS.120V COFFEE DOSER COIL ASS.120V
	9		9129.A21.00A	DOSER COIL FOR SUPERAUTOM.230V ASSY. DOSER COIL FOR SUPERAUTOM.230V ASSY.

Model Machine

MACSAE019























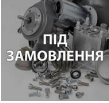

SAECO ROYAL OFFICE (0368.00B.77C)

	10		NE05.017	MICROSWITCH <i>MICROSWITCH NE05.017</i>
	11		9161.072.150	GREY MICRO SUPP.CURSOR GROUND COF.DOSER <i>MICRO SUPPORT CURSOR GREY</i>
	12		9161.073.150	GREY GROUND COF.DOSE CONTROL COMPENSATOR <i>DOSE CONTROL COMPENSATOR GREY</i>
	13		9161.079.150	GREY GRIND COFFEE CONVEYOR MAGIC <i>GREY GRIND COFFEE CONVEYOR MAGIC</i>
	14		0368.821	2 POLE CONNECTOR <i>2 POLE CONNECTOR</i>
	15		0368.801	2POLES CONNECTOR GRINDER MOTOR ROYAL <i>2POLES CONNECTOR GRINDER MOTOR ROYAL</i>
	16		144320200	SELF LOCK STRIP W=2.6 L=200 <i>SELF LOCK STRIP W=2.6 L=200</i>
	17		9161.365.150	GREY PLATE COFFEEGRINDER MAGIC/ROYAL <i>PIASTRA X MACINACAFFE' GRIGIO/7016</i>
	18		9161.382	INSULATOR FOR COFFEE GRINDER <i>INSULATOR FOR COFFEE GRINDER</i>
	19		9161.366.150	GREY/7016 SUPPORT FOR INSULATOR <i>SUPPORTO X ISOLANTE GRIGIO</i>
	20		U043.004	ZN-B TCB TORX 20 M4X16 ZN-B <i>VITE TCBC M4,0X16 UNI 7687 ZNP</i>
	21		9991.005	RUBBER FOR COFFEE GRINDER <i>GOMMINO X MACINA CAFFE</i>
	22		9141.003	SPACER FOR RUBBER <i>SPACER FOR RUBBER</i>
	23		U324.006	ШАЙБА M4 <i>NUT M4 FLANGED INDENTED BASE</i>

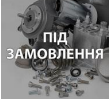
Model Machine

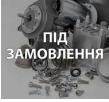
MACSAE019











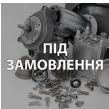





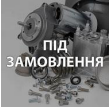

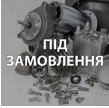



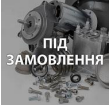

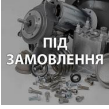

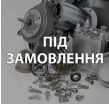
SAECO ROYAL OFFICE (0368.00B.77C)

	24		NE05.037	MICROSWITCH <i>MICROINTERRUTTORE</i>
	25		9140.035.00A	ASS.MACINACAFFE'ITA 230V <i>ASS.MACINACAFFE'ITA 230V</i>
	25		9140.036.00A	КАВОМОЛКА В ЗБОРІ 230V PHILIPS SAECO 996530065687 <i>COFFEE GRINDER STD 230V ASSY.</i>
	25		9140.036.00F	ASS.MOTOR STD 120V <i>ASS.MOTOR STD 120V</i>
	25		9140.036.00R	ASS.MOTOR STD 100V 50/60HZ <i>ASS.MOTOR STD 100V 50/60HZ</i>
	26		1505.020	ГУМОВИЙ УЦІЛЬНЮВАЧ КАВОМОЛКИ PHILIPS SAECO 996530046547 <i>GASKET COFFEE GRINDER UL</i>
	27		1505.014	COFFEEGRINDER SEAL <i>GUARNIZIONE DOSATORE</i>
	28		9991.103	АМОРТИЗАТОР ДЛЯ КОФЕМОЛКИ КОФЕМАШИН PHILIPS SAECO 996530... <i>AMMORTIZZATORE PER MACINACAFE</i>
	29		0301.R10.00A	SPARE MOTOR UNIT MC 230V <i>GRUPPO RICAMBIO MOTORE MC 230 V</i>
	29		1501.R09.00F	MOTOR SPARE UNIT 120V <i>MOTOR SPARE UNIT 120V</i>
	29		1501.R09.00R	MOTOR SPARE UNIT 100V <i>MOTOR SPARE UNIT 100V</i>
	30		140360200	FELT RING 40X34X5 <i>ANELLO IN FELTRO DE=40 DI=34</i>
	31		9161.097.150	GREY GROUND COF.DOSER LEVER FIXING PLATE <i>LEVER FIXING PLATE GREY</i>

Model Machine

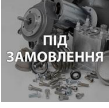
MACSAE019













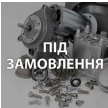









SAECO ROYAL OFFICE (0368.00B.77C)

	32		9161.077.150	DOSE ADJUSTMENT LEVER DE LUXEGREY <i>DOSE ADJUSTMENT LEVER DE LUXE GREY</i>
	33		126765517	STEEL SPRING SPHERE D=5,5 MOTOR MAGIC <i>MOLLA ACC.X SFERA D=5,5 MOTO</i>
	34		129511803	SCREW TCB 2,9X6,4 DIN 7981 NICK <i>SCREW TCB 2,9X6,4 DIN 7981 NICK</i>
	35		0333.045.660	GRINDING ADJUSTMENT INDICATOR <i>GRINDING ADJUSTMENT INDICATOR</i>
	35		0333.045.840	GRINDING ADJUSTMENT INDICATOR <i>GRINDING ADJUSTMENT INDICATOR</i>
	36		0333.008	STEEL GRINDING ADJUSTMENT LEVER <i>STEEL GRINDING ADJUSTMENT LEVER</i>
	37		0333.009	BLK GRINDING ADJUST.LEVER HANDGRIP ROYAL <i>BLK GRINDING ADJUST.LEVER HANDGRIP ROYAL</i>
	38		0333.A07.660	GRINDING ADJ. LEVER ASS. SILVER TF <i>GRINDING ADJ. LEVER ASS. SILVER TF</i>
	38		0333.A07.840	GRINDING ADJ. LEVER ASS. <i>ASS.LEVA REGOLAZIONE MACINATURA</i>
	39		129512503	SCREW TCB 2,9X9,5 DIN 7981 NICK <i>SCREW TCB 2,9X9,5 DIN 7981 NICK</i>
	40		U201.001	PLAIN WASHER 3,2X9 DIN 7349 GALV. <i>PLAIN WASHER 3,2X9 DIN 7349 GALV.</i>
	41		9161.404.150	DOSE ADJUST. SCALE GREY RAL 7016 <i>DOSE ADJUST. SCALE GREY RAL 7016</i>
	42		149186150	BLACK UPPER GRINDER SUPPORT MAGIC <i>SUPPORT.NER.X MACINA SUPERIO</i>
	43		9141.039	UPPER GRINDER <i>UPPER GRINDER</i>

Model Machine

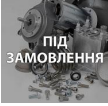
MACSAE019

SAECO ROYAL OFFICE (0368.00B.77C)

	44		142844550	UPPER GRINDER COVER COFFEE GRIND. MAGIC <i>UPPER GRINDER COVER COFFEE GRIND. MAGIC</i>
	45	 ПІД ЗАМОВЛЕННЯ	129931002	TORX SCREW T10 TCB 3,5X40 SX ZNG <i>TORX SCREW T10 TCB 3,5X40 SX ZNG</i>
	46		147470763	BLK INCREASE SCREW PIN COF.GRINDER MAGIC <i>PERNO INCREM.A VITE X MACINA</i>
	47		U201.002	PLAIN WASHER 10X16X0,2DIN 988GAL <i>ROSETTA PIANA 10X16X0,2DIN</i>
	48		9141.040	CONICAL GRINDER <i>CONICAL GRINDER</i>
	49	 ПІД ЗАМОВЛЕННЯ	149188750	CONICAL GRIND. SUPP. + RING MAGIC <i>CONICAL GRIND. SUPP. + RING MAGIC</i>
	50		146570950	RING NUT FOR GRINDING ADJUSTMENT MAGIC <i>GHIERA NERA REGOLAZ.MACINATU</i>
	51		128610421	STAIL.STELL AISI 304 SPHERE D=3,2MM <i>SFERA D=3,2MM ACCIAIO INOX A</i>
	52		126770117	NEW SPRING SPHERE D=3,2 MOTORMAGIG <i>MOLLA NEW X SFERA D=3,2 MOTORE MAGIC</i>
	53	 ПІД ЗАМОВЛЕННЯ	9141.080	ТРИМАЧ ДВИГУНА КАВОМОЛКИ ДЛЯ КАВОВАРКИ SAECO 9141.080 <i>SUPPORTO MOTORE</i>
	54		140230400	SHOCK ABS .CONICAL GRINDER SUPP.MAGIC <i>AMMORTIZ.X SUPPOR.MACIN.CONI</i>
	55		128610521	STAIL.STEEL AISI 304 SPHERE D=5,5MM <i>SFERA D=5,5MM ACCIAIO INOX A</i>

Model Machine

MACSAE019

SAECO ROYAL OFFICE (0368.00B.77C)

MACSAE019.T.0005

TAVOLA NR. 5 - ARTICOLO SAECO ROYAL OFFICE (0368.00B.77C)

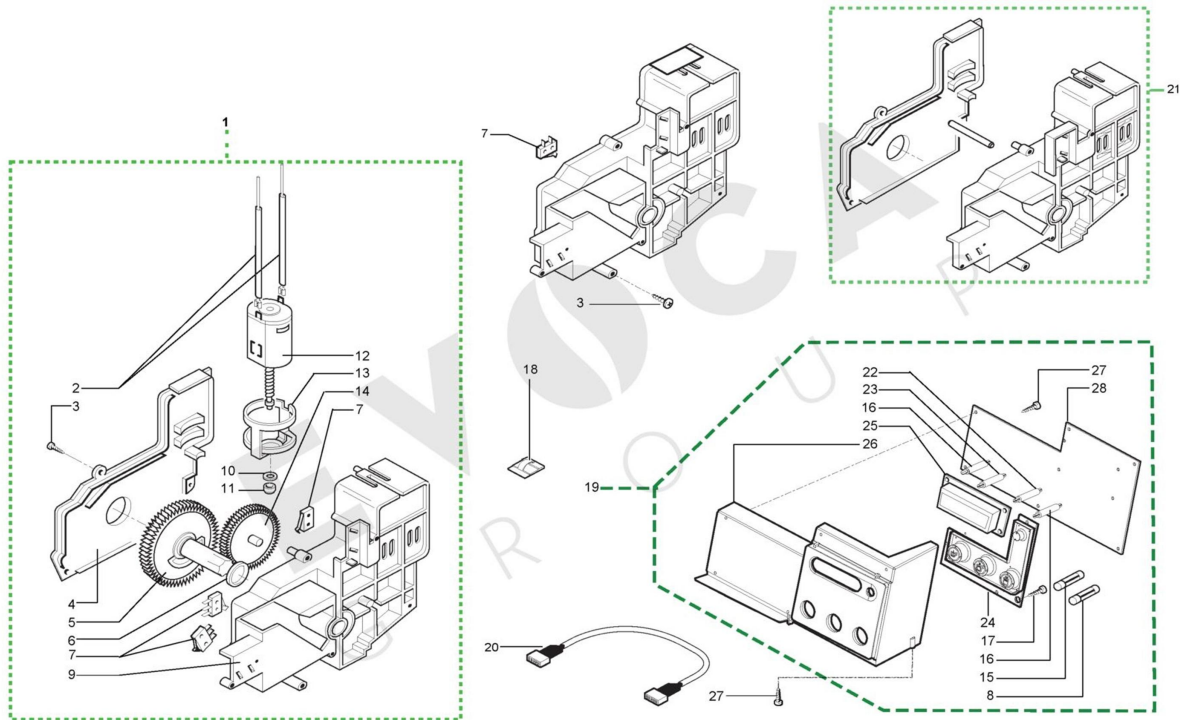

Model Machine

MACSAE019

SAECO ROYAL OFFICE (0368.00B.77C)

Web Pos. Foto Item - Replace by Description



Press - CTRL + CLICK go to item in a new window

Натисніть - Ctrl + права кнопка миші щоб відкрити запчастину в новому вікні



1

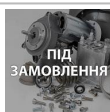

11005029

WIRED RATIOMOTOR OFFICE GREY ASSY.
WIRED RATIOMOTOR OFFICE GREY ASSY.



1



9120.021.150

WIRED RATIOMOTOR OFFICE GREY ASSY.
WIRED RATIOMOTOR OFFICE GREY ASSY.



2

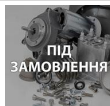

0333.810

CONN.2 POLE RATIOMOTOR OFFICE
CONN.2 POLE RATIOMOTOR OFFICE



2

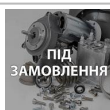

0333.821

2POLES CONNECT.RATIOMOTOR OFFICE UL ASSY
2POLES CONNECT.RATIOMOTOR OFFICE UL ASSY



3



129670202

TCB PANELVIT SCREW 3,5X16 TESTA D=8 ZNP
TCB PANELVIT SCREW 3,5X16 TESTA D=8 ZNP



4

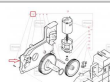

17000719

GREY RATIOMOTOR LID RYL
GREY RATIOMOTOR LID RYL



5



9121.069.150

GEAR Z=108 FOR MOUNTING PLATEM4000
INGRANAG.Z=108 PIASTRA MONT.M4000 GRIGIO



6



9161.368

MYLAR WASHER FOR RATIOMOTOR
RONDELLA MYLAR X MOTORIDUTTORE



7



NE05.038

MICROSWITCH 30V 0.3A
MICROINTERRUTTORE



8



NE13.044

FUSE 5,0X20 8A 250V DELAYED
FUSE 5,0X20 8A 250V DELAYED



9

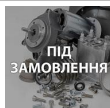

11027899

GREY RATIOMOTOR CASING W/DUCTV2 ASSY.
GREY RATIOMOTOR CASING W/DUCT V2 ASSY.



10



148380200

BAKELIZZATE WASHER D=5,5
BAKELIZZATE WASHER D=5,5



11



















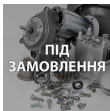

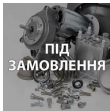

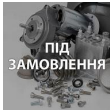

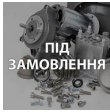

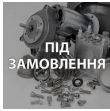

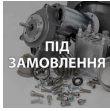
9121.046

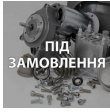
BRONZE SINTERED BUSH FOR MOTORRATIOMOT.
BRONZE SINTERED BUSH FOR MOTOR RATIOMOT.

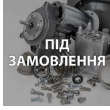
Model Machine

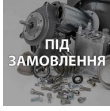
MACSAE019

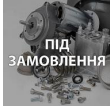















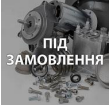





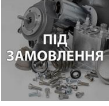

SAECO ROYAL OFFICE (0368.00B.77C)

	12		11005214	MOTOR FOR RATIOMOTOR ASSY. <i>MOTOR FOR RATIOMOTOR P124 ASSY</i>
	13		9121.044	ANTIVIBRATION FOR MOTOR <i>ANTIVIBRANTE X MOTORE</i>
	14		9121.042	GEAR Z=12/90 <i>INGRANAGGIO Z.12/90 PREZZO NUOVO 0,33</i>
	15	 ПІД ЗАМОВЛЕННЯ	NE13.010	FUSE 5,0X20 T 315MA 250V UL <i>FUSE 5,0X20 T 315MA 250V UL</i>
	16	 ПІД ЗАМОВЛЕННЯ	NL04.006	RICHCO SPACER MSPM-6-01 <i>RICHCO SPACER MSPM-6-01</i>
	17	 ПІД ЗАМОВЛЕННЯ	U145.002	SCREW AUT.TCB 3,0X6,0 PT WN 1412 S <i>SCREW AUT.TCB 3,0X6,0 PT WN 1412 S</i>
	18	 ПІД ЗАМОВЛЕННЯ	NE17.018	ADHESIVE ROUND CABLE RETAINER <i>ADHESIVE ROUND CABLE RETAINER</i>
	19	 ПІД ЗАМОВЛЕННЯ	0368.R01.77A	SPARES ASS.ELECTRONIC OFFICE 230V <i>SPARES ASS.ELECTRONIC OFFICE 230V</i>
	19	 ПІД ЗАМОВЛЕННЯ	0368.R01.77F	SPARES ASS.ELECTRONIC OFFICE 120V <i>SPARES ASS.ELECTRONIC OFFICE 120V</i>
	19	 ПІД ЗАМОВЛЕННЯ	0368.R02.77F	SPARES ASS.ELECTRONIC OFFICE 120V <i>SPARES ASS.ELECTRONIC OFFICE 120V</i>
	19	 ПІД ЗАМОВЛЕННЯ	0368.R03.77A	SPARES ASS.ELECTRONIC OFFICE 230V <i>SPARES ASS.ELECTRONIC OFFICE 230V</i>
	19	 ПІД ЗАМОВЛЕННЯ	0368.R08.77A	SPARES ELECTRONIC OFFICE 230VASSY. <i>SPARES ELECTRONIC OFFICE 230V ASSY.</i>
	19	 ПІД ЗАМОВЛЕННЯ	0368.R08.77F	SPARES ASS.ELECTRONIC OFFICE 120V <i>SPARES ASS.ELECTRONIC OFFICE 120V</i>
	19	 ПІД ЗАМОВЛЕННЯ	0368.R09.77F	SPARES ASS.ELECTRONIC OFFICE 120V <i>SPARES ASS.ELECTRONIC OFFICE 120V</i>

Model Machine

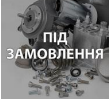
MACSAE019

SAECO ROYAL OFFICE (0368.00B.77C)

	19		0368.R10.77A	SPARES ASS.ELECTRONIC OFFICE 230V <i>SPARES ASS.ELECTRONIC OFFICE 230V</i>
	20		0368.808	FLAT CONNECTION CARDS <i>FLAT CONNECTION CARDS</i>
	21		20007052	SPARES KIT GEARS FOR RATIOMOTOR RYL <i>SPARES KIT GEARS FOR RATIOMOTOR RYL</i>
	22		NL04.005	RICHCO SPACER MSPM-5-01 BD <i>RICHCO SPACER MSPM-5-01 BD</i>
	23		NL04.004	RICHCO SPACER MSPM-7-01 BK <i>RICHCO SPACER MSPM-7-01 BK</i>
	24		0333.803	TOUCH PANEL CARD ASS. <i>ASS.SCHEDA TASTIERA</i>
	25		0347.816	DISPLAY FOR ROYAL REDESIGN <i>DISPLAY FOR ROYAL REDESIGN</i>
	26		0333.049.770	SILVER ELECTRONIC SUPPORT ROYAL + LENS <i>SILVER ELECTRONIC SUPPORT ROYAL + LENS</i>
	26		0333.063.770	ELECT. SUPPORT S/SCREENED UL SILVER <i>ELECT. SUPPORT S/SCREENED UL SILVER</i>
	27		U140.004	PANELVIT TCB 3,0X12 DIN 7505 BGAL <i>PANELVIT TCB 3,0X12 DIN 7505 B ZNP</i>
	28		0368.803.00A	CPU CARD OFFICE UP.GRADE ITA 230V <i>CPU CARD OFFICE UP.GRADE ITA 230V</i>
	28		0368.804.00A	SCHEDA CPU OFFICE STD 230V <i>SCHEDA CPU OFFICE UP-GRADE S</i>
	28		0368.804.00F	CPU CARD OFFICE UP.GRADE STD 120V <i>CPU CARD OFFICE UP.GRADE STD 120V</i>

Model Machine

MACSAE019

SAECO ROYAL OFFICE (0368.00B.77C)



28

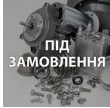

0368.R11.00A

SPARES CPU CARD ITA 230V
SPARES CPU CARD ITA 230V



28

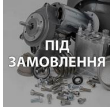

0368.R12.00A

SPARES
SPARES



28

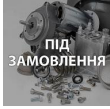

0368.R12.00F

SPARES
SPARES

Model Machine

MACSAE019

SAECO ROYAL OFFICE (0368.00B.77C)

MACSAE019.T.0006



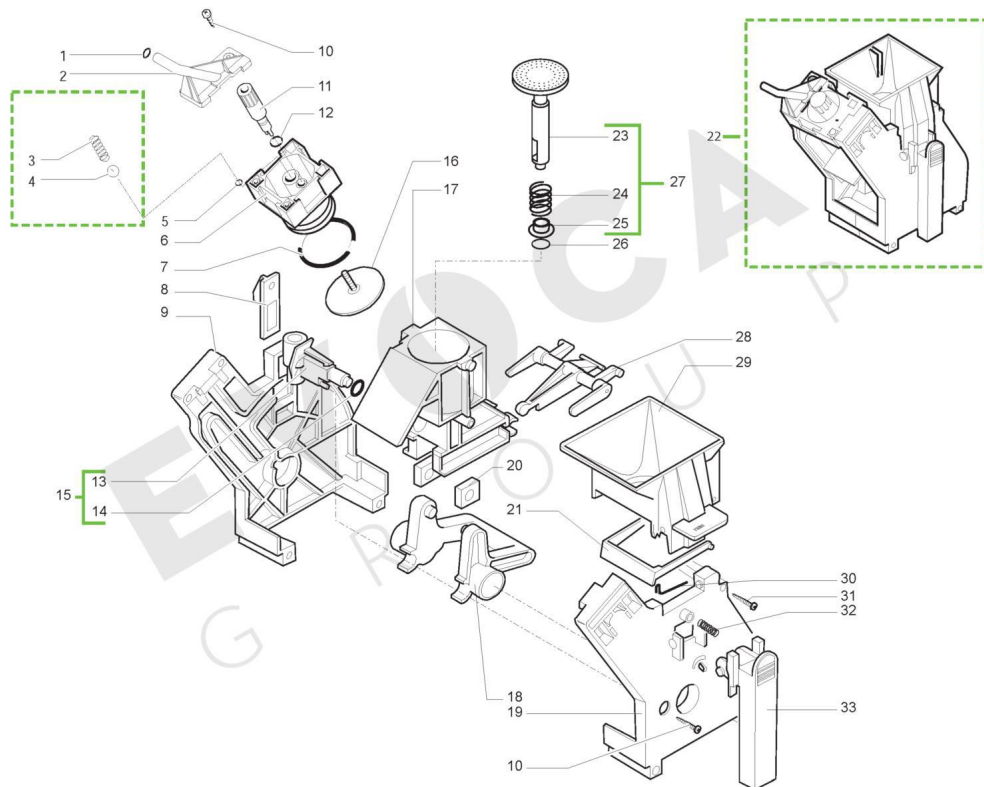

















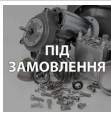





TAVOLA NR. 6 - ARTICOLO SAECO ROYAL OFFICE (0368.00B.77C)



Model Machine

MACSAE019























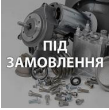



SAECO ROYAL OFFICE (0368.00B.77C)

Web	Pos.	Foto	Item - Replace by	Description
				<i>Press - CTRL + CLICK go to item in a new window Натисніть - Ctrl + права кнопка миші щоб відкрити запчастину в новому вікні</i>
	1		NM02.017	OR ORM 0055-15 TERMOIL OR ORM 0055-15 TERMOIL
	2		9161.034.150	GREY COFFEE OUTLET SLEEVE MANICOTTO USCITA CAFFE' GRIG
	3		9161.222	SS.CONICAL SPRING MOLLA CONICA
	4		9161.320	VALVE FOR UNIT VALVOLA X GRUPPO CAFFE'
	5		NM02.013	OR ORM 0080-15 TERMOIL OR ORM 0080-15 TERMOIL
	6		9161.193.150	GREY BREW UNIT COUNTERPISTON M5000 CONTROPISTONE X GRUPPO GRIGI
	7		NM01.044	OR ORM 0320-40 SILICONE PTFE/FDA OR ORM 0320-40 SILICONE PTFE
	8		9161.067.150	GREY BREW UNIT COUPLING PLATE PIASTRINA X AGGANCIAMENTO GRUPPO CAFFE'GRIGIO
	9		9161.070.150	GREY BREW UNIT REAR PLATE M5000 PIASTRA POSTERIORE GRUPPO CAFFE' GRIGIO
	10		U140.019	SCREW TCB TORX 10 3X16 PLAST SS PANELVIT TCB 3,0X16 DIN 7505
	11		227470150	PIN BLACK ASS.FOR PERCOLATOR PIN BLACK ASS.FOR PERCOLATOR
	12		NM02.006	OR R5 TERMOIL OR R5 EPDM
	13		9161.064.150	ВХІДНИЙ КЛАПАН ЗАВАРЮВАЛЬНОГО БЛОКУ КАВОВАРКИ SAECO ПРО... MANICOTTO ENTRATA ACQUA GRUP.CAF.GRIGIO CON OR NM02.007 - F...

Model Machine

MACSAE019

SAECO ROYAL OFFICE (0368.00B.77C)

	14		NM02.007	OR 2025 IN TERMOIL OR 2025 TERMOIL
	15		0301.R04.150	GREY WATER INLET SLEEVE BREW UNIT ASSY. GREY WATER INLET SLEEVE BREW UNIT ASSY.
	16		20000400	ВЕРХНІЙ ФІЛЬТР ВАРОЧНОГО БЛОКУ DE=35,8 PHILIPS SAECO 99653000... SPARE UNIT PERCOLATOR DE=35,8 WIT.INSERT
	17		9161.195.150	GREY BREW UNIT COFF.CONTAINERM5000 ASSY CONTENITORE COMPL.X GRUPPO G
	18		9161.066.150	GREY BREW UNIT ELBOW SHAFT M5000 ALBERO A GOMITO X GRUPPO GRIGIO
	19		9161.071.150	GREY BREW UNIT FRONT PLATE M5000 9161.071.150
	20		9161.094.150	GREY BREW UNIT DRILLED BLOCK GREY BREW UNIT DRILLED BLOCK
	21		9161.060.150	GREY SCRAPER FOR BREW UNIT M5000 RASATORE X GRUPPO GRIGIO
	22		11004189	BLACK BREW UNIT NEW ROYAL OFFICE BLACK BREW UNIT NEW ROYAL OFFICE
	23		9161.306.150	GREY BREW UNIT INTEGRAL PISTON8GR.ASSY. ASS.PISTONE INTEGRALE GRIGIO
	24		9161.198	SS.8GR.BREW UNIT PISTON SPRING SS.8GR.BREW UNIT PISTON SPRING
	25		9161.191	WHITE 8GR.-12GR.BREW UNIT PISTON BUSH BOCCOLA X PISTONE NEUTRO
	26		NM02.018	OR ORM 0090-25 TERMOIL OR ORM 0090-25 TERMOIL
	27		9161.343.150	GREY 8GR.BREW UNIT NTEGR.PISTON GEN.ASSY ASS.PISTONE INTEGRALE

Model Machine

MACSAE019

SAECO ROYAL OFFICE (0368.00B.77C)

	28		9161.065.150	GREY CONNECTING ROD BREW UNIT8GR. <i>GREY CONNECTING ROD BREW UNIT 8GR.</i>
	29		9161.123.150	GREY HOPPER COFF.BREW UNIT S/SCR.M5000 <i>TRAMOGGIA GRUPPO CAFFE' GRIGIO SER.PRESS</i>
	30		9161.046	ПРУЖИНА ВОРОНКИ ЗАВАРОЧНОГО БЛОКА ДЛЯ КОФЕМАШИН PHILIPS ... <i>MOLLA X RASATORE GRUPPO</i>
	31	 ПІД ЗАМОВЛЕННЯ	U109.026	SS.SCREW AUT.TCB 3,5X19 DIN 7981 C <i>SS.SCREW AUT.TCB 3,5X19 DIN 7981 C</i>
	32		9161.045	SS BREW UNIT HANDGRIP SPRING M5000 <i>MOLLA X IMPUGNATURA GRUPPO</i>
	33		9161.069.150	GREY BREW UNIT HANDGRIP M5000 <i>IMPUGNATURA X GRUPPO GRIGIO</i>