

# Model Machine

MACSAE154

ROYAL GRANCREMA ЧЁРНАЯ

MACSAE154.T.0001



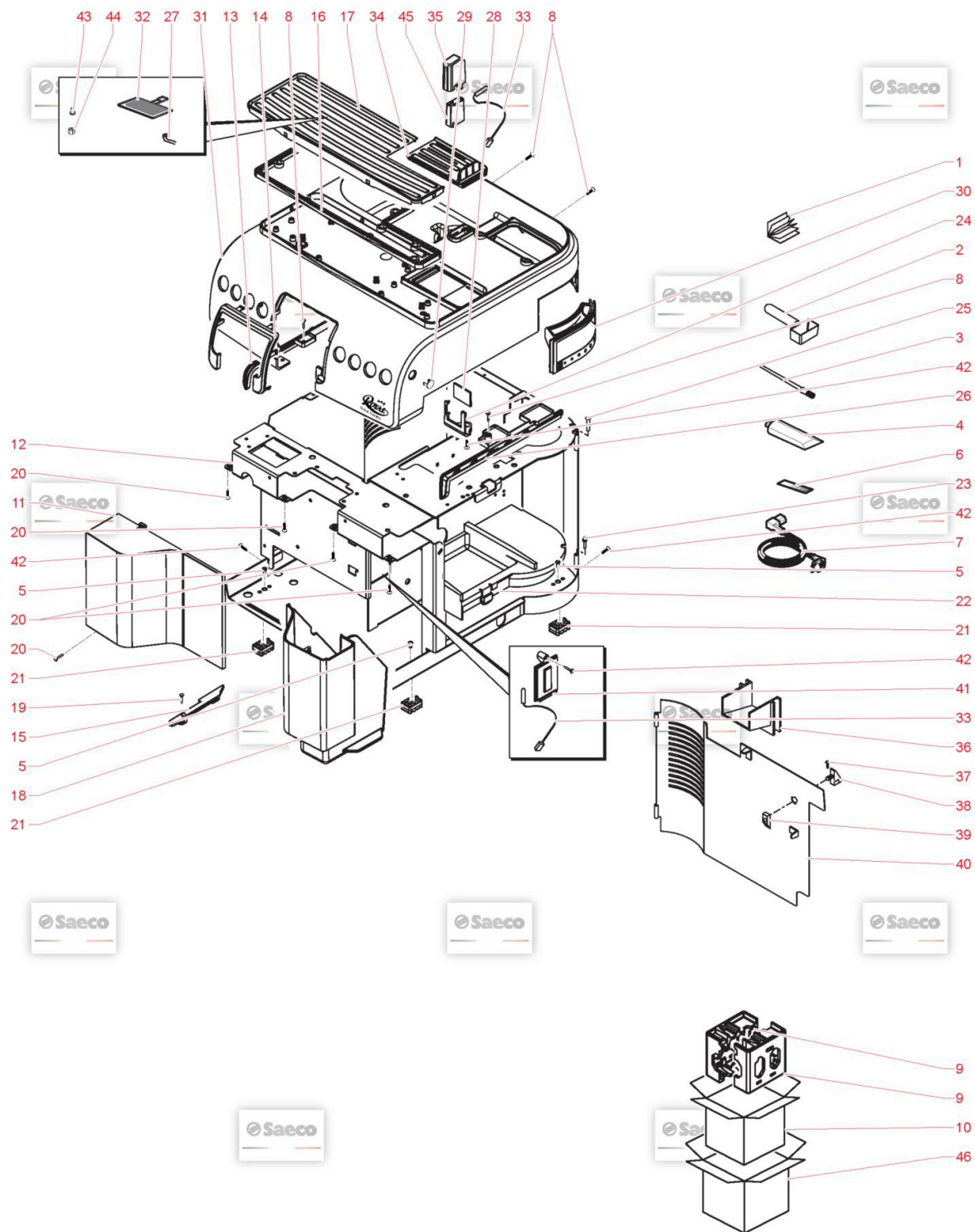









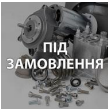

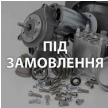

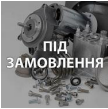

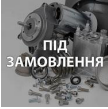

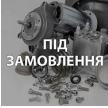

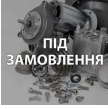

TAVOLA NR. 1 - ARTICOLO ROYAL GRANCREMA ЧЁРНАЯ



## Model Machine

MACSAE154

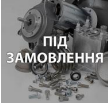

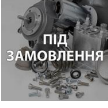









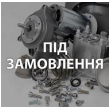

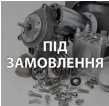











ROYAL GRANCREMA ЧЁРНАЯ

Web	Pos.	Foto	Item - Replace by	Description
				<i>Press - CTRL + CLICK go to item in a new window Натисніть - Ctrl + права кнопка миші щоб відкрити запчастину в новому вікні</i>
	1		421946025641	MANUAL SAE SUP044 RYL/H DE <i>LIB.IST.SAE SUP044 RYL/H DE</i>
	1		421946025651	MANUAL SAE SUP044 RYL/H ES <i>MANUAL SAE SUP044 RYL/H ES</i>
	1		421946025661	MANUAL SAE SUP044 RYL/H FR <i>MANUAL SAE SUP044 RYL/H FR</i>
	1		421946025671	MANUAL SAE SUP044 RYL/H GB <i>MANUAL SAE SUP044 RYL/H GB</i>
	2		421944033301	BLK ABS COFFEE MEASURE SMART <i>BLK ABS COFFEE MEASURE SMART</i>
	4		145550100	GREASE KLUBER ISOFLEX TOPAS NCA 52 <i>GREASE KLUBER ISOFLEX TOPAS NCA 52</i>
	5		11021769	BLACK RIGID FOOT FIXING PIN MYB9 <i>BLACK RIGID FOOT FIXING PIN MYB9</i>
	6		0301.961	STICKER FOR WATER HARDNESS TEST <i>TEST DUREZZA ACQUA</i>
	7		183911050	ЧОРНИЙ КАБЕЛЬ SCHUKO L=1200 SAECO <i>BLACK POWER CABLE SCHUKO L=1200</i>
	8		12001622	SCREW TCB TORX B 3,5X9,5 SCHEET NIK <i>SCREW TCB TORX B 3,5X9,5 SCHEET NIK</i>
	9		20006994	KIT PS-E INSERT FOR BOX RYL <i>KIT PS-E INSERT FOR BOX RYL</i>
	10		13001640	WHITE BOX RYL/T SAE ROYAL ONETOUCH CEE <i>WHITE BOX RYL/T SAE ROYAL ONE TOUCH CEE</i>

## Model Machine

MACSAE154













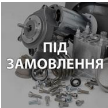









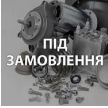



ROYAL GRANCREMA ЧЁРНАЯ

	11		11031091	TXO/BLK FRONT CASING COVER RYL/H <i>TXO/BLK FRONT CASING COVER RYL/H</i>
	12		11025823	BLACK STEEL CASING RYL/T ASSY. <i>BLACK STEEL CASING RYL/T ASSY.</i>
	13		17002110	BLACK CASING LEFT CLOSING INSERT RYL/H <i>BLACK CASING LEFT CLOSING INSERT RYL/H</i>
	14		11030103	CRC FRONT PANEL RYLO <i>CRC FRONT PANEL RYLO</i>
	15		17000723	GREY DUMP BOX GUIDE RYL <i>GREY DUMP BOX GUIDE RYL</i>
	16		17000349	BLACK SEAL FOR CUPWARMING LIDRYL <i>BLACK SEAL FOR CUPWARMING LID RYL</i>
	17		17000175	SB/SS CUPWARMING LID RYL <i>SB/SS CUPWARMING LID RYL</i>
	18		11031092	TXO/BLK DUMP BOX RYL ASSY. <i>AS.CAS.FONDI RYL VERN.NER/TXO</i>
	19		12000895	SCREW TSP TORX 10 3X10 PLAST.SS <i>SCREW TSP TORX 10 3X10 PLAST.SS</i>
	20		129535721	SCREW TSP TORX 10 AB 3,5X9,5 SHEET SS <i>SCREW TSP TORX 10 AB 3,5X9,5 SHEET SS</i>
	21		11021829	ФІКСУЮЧИЙ НІС НИЖНІЙ ЧАСТИНИ КОРПУСУ (НІЖКИ) PHILIPS SAECO 9... <i>BLACK/TRANSP.RIGID FOOT MYB9</i>
	22		0301.041.150	GREY BREW UNIT SUPPORT PLATE ROYAL <i>PIASTRA SUPPORTO GRUPPO GRIGIO</i>
	23		0301.020	NIK/BRASS PIN FOR DOOR SUPERAUT. <i>NIK/BRASS PIN FOR DOOR SUPERAUT.</i>
	24		17000391	BLACK WATER LEVEL SENSOR SUPPORT RYL <i>BLACK WATER LEVEL SENSOR SUPPORT RYL</i>

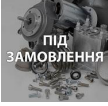
## Model Machine

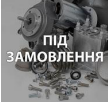
MACSAE154















ROYAL GRANCREMA ЧЁРНАЯ

	25		0301.019	NIK/BRASS PIN FOR DOOR SUPERAUT. <i>NIK/BRASS PIN FOR DOOR SUPERAUT.</i>
	26		11031307	BLACK CASING RIGHT CLOSING INSERT RYL <i>BLACK CASING RIGHT CLOSING INSERT RYL</i>
	27		421946000521	2P.CONN.SUPPLY CUPWARMER V2 RYL UL ASSY. <i>2P.CONN.SUPPLY CUPWARMER V2 RYL UL ASSY.</i>
	28		421941306721	ПЛАТА-СЕНСОР РІВНЯ ВОДИ V3 A <i>CPU+SW WATER LEVEL SENSOR V3 ASSY.</i>
	29		17000422	TRANSP.INFRAREDS PLATE RYL <i>TRANSP.INFRAREDS PLATE RYL</i>
	30		11031086	TXO/BLK COVER CASING INSERT S/SCR.RYL <i>TXO/BLK COVER CASING INSERT S/SCR.RYL</i>
	31		421944046311	TXO/BLK CAS.COVER S/S.GRANCREMA V2 RYL/H <i>TXO/BLK CAS.COVER S/S.GRANCREMA V2 RYL/H</i>
	32		WGA4316031000	ADHESIVE HEATING-ELEMENT 230V <i>ADHESIVE HEATING-ELEMENT 230V</i>
	33		17800442	2POLES CONNECT.SENSOR REED DUMP BOX CST <i>2POLES CONNECT.SENSOR REED DUMP BOX CST</i>
	34		11025739	SB/SS GROUND CONT.DOOR COVER S/S.RYL ASS <i>AS.COP.SPORT.CONT.CAF.MAC.RYL IN/SB SER.</i>
	35		11031306	BLACK BEAN CONTAINER SENSOR SUPPORT RYL <i>SUPP.SENS.CONT.CAF.GRA.RYL NER.</i>
	36		11027680	7021/GREY DOOR COVER S/SCR.RYL <i>7021/GREY DOOR COVER S/SCR.RYL</i>
	37		U433.001	NAIL 2X6 UNI 7591 BURN. <i>NAIL 2X06 UNI 7591 BURN.</i>
	38		0301.039.710	7021/GREY DOOR CLOSURE KNOB <i>DOOR CLOSURE KNOB GREY</i>

## Model Machine

MACSAE154

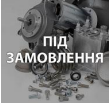
ROYAL GRANCREMA ЧЁРНАЯ

	39		0301.040.150	GREY DOOR CLOSURE LEVER <i>GREY DOOR CLOSURE LEVER</i>
	40		11031113	BLACK STEEL CASING DOOR RYL <i>BLACK STEEL CASING DOOR RYL</i>
	41		17000240	GREY MOUNTING PLATE INSERT RYL <i>GREY MOUNTING PLATE INSERT RYL</i>
	42		12000450	SCREW TCBR TORX 10 3,5X12 PLAST.ZN-N <i>SCREW TCBR TORX 10 3,5X12 PLAST.ZN-N</i>
	43		17000826	BRASS CUPWARMING LID BUSH RYL <i>BRASS CUPWARMING LID BUSH RYL</i>
	44		U324.005	NUT M3 FLANGED INDENTED BASE <i>DADO M3 FLANGIATO BASE DENTELLATA</i>
	45		17001480	BLK BEAN CONTAIN.SENSOR SUPP.INSERT RYL <i>BLK BEAN CONTAIN.SENSOR SUPP.INSERT RYL</i>
	46		421946001171	WHT EXTERNAL BOX RYLO/P SAE 27L. <i>WHT EXTERNAL BOX RYLO/P SAE 27L.</i>

# Model Machine

MACSAE154

ROYAL GRANCREMA ЧЁРНАЯ

MACSAE154.T.0002

TAVOLA NR. 2 - ARTICOLO ROYAL GRANCREMA ЧЁРНАЯ

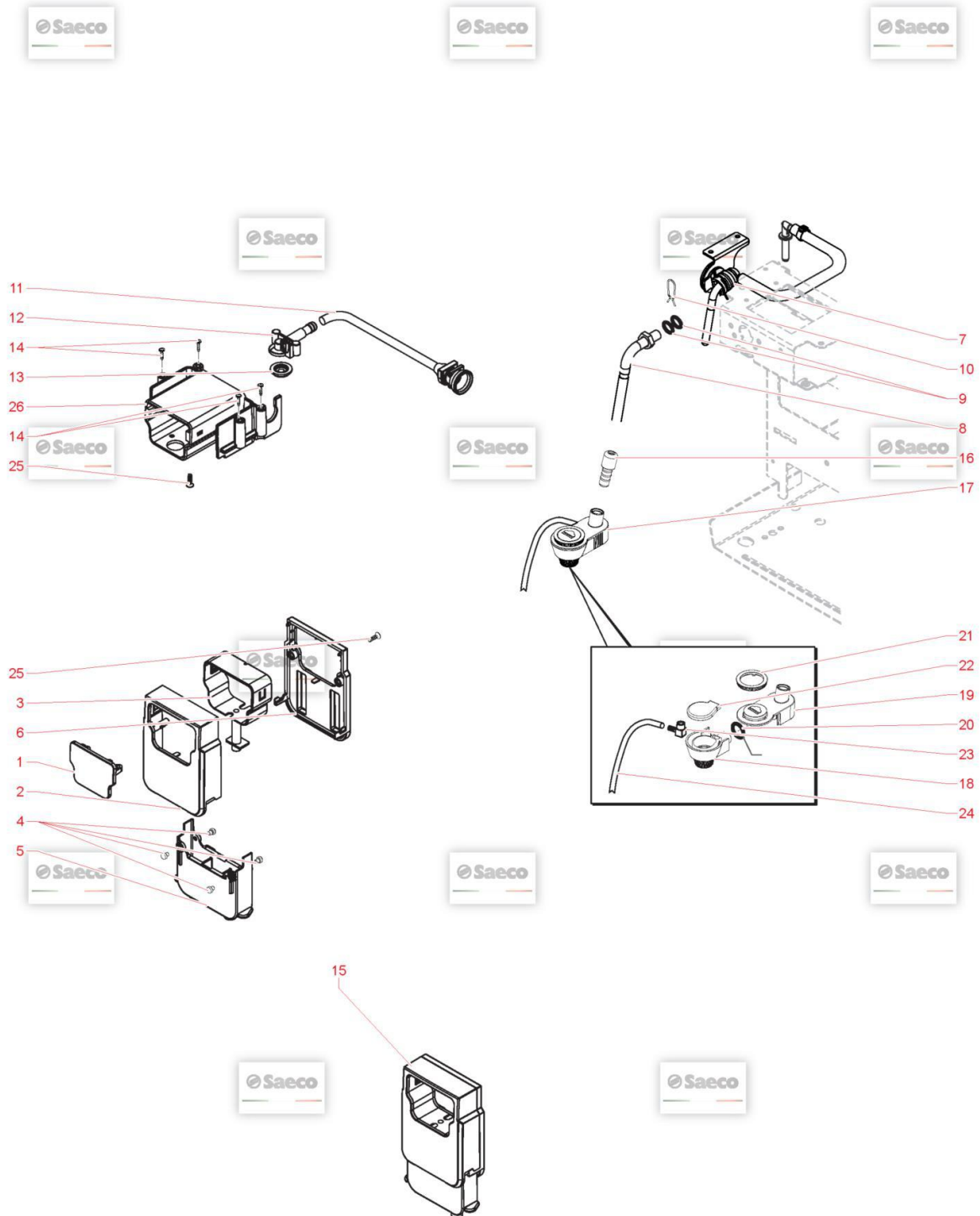

## Model Machine

MACSAE154

ROYAL GRANCREMA ЧЁРНАЯ

Web Pos. Foto Item - Replace by Description



*Press - CTRL + CLICK go to item in a new window  
Натисніть - Ctrl + права кнопка миші щоб відкрити запчастину в новому вікні*



1



11031102

ФРОНТАЛЬНА КРИШКА ДІСПЕНСЕРУ  
CRC FRONT COFFEE DISPENSER COVER RYL/H



2

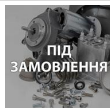

11030102

CRC FRONT COF.DISPENSER COVER RYL  
CRC FRONT COF.DISPENSER COVER RYL



3

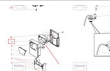

17000251

BLACK INNER BODY COFFEE DISPENS.RYL  
BLACK INNER BODY COFFEE DISPENS.RYL



4

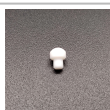

11013085

WHITE COFFEE DISPENSER SLIDER MYB9  
WHITE COFFEE DISPENSER SLIDER MYB9



5



17000246

ЧОРНА ЗАГЛУШКА ЧАСТИНИ КАВОВОГО ДІСПЕНСОРА  
BLACK EXT.MOBILE PART COF.DISPENSER RYL



6



17000248

BLACK REAR COVER COFFEE DISPENSER RYL  
BLACK REAR COVER COFFEE DISPENSER RYL



7

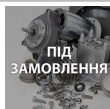

421944049351

TF/CHROM.STEAM TUBE V5 RYL/T ASSY.  
AS.TUBO VAP.V5 RYL/T OT/TEA OT/CROM.TF



8

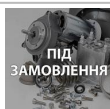

421944045701

TF/CHROM.STEAM TUBE RYL ASSY.  
TF/CHROM.STEAM TUBE RYL ASSY.



9



140324461

OR ORM 0060-20 TERMOIL  
OR ORM 0060-20 IN TERMOIL



10



126764018

SS SPRING D=1 STEAM TUBE HOLDER JUN.  
SPRING D=1STEAM TUBE HOLDER JUN.



11



17000614

BLACK DISPENSER COFF.INLET CONNECT.RYL  
BLACK DISPENSER COFF.INLET CONNECT.RYL



12



17000616

BLACK COFFEE DISPENSER TUBE RYL  
BLACK COFFEE DISPENSER TUBE RYL



13















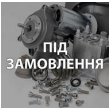











17000337

BLACK SEAL FOR COFFEE DISPENSER RYL  
BLACK SEAL FOR COFFEE DISPENSER RYL

## Model Machine

MACSAE154

ROYAL GRANCREMA ЧЁРНАЯ

	14		12000450	SCREW TCBR TORX 10 3,5X12 PLAST.ZN-N SCREW TCBR TORX 10 3,5X12 PLAST.ZN-N
	15	 ПІД ЗАМОВЛЕННЯ	11030101	CRC COFFEE DISPENSER RYL ASSY. AS.EROG.CAF.RYL CRC
	16		421941301142	BLK STEAM TUBE INSERT V2 SMR/H BLK STEAM TUBE INSERT V2 SMR/H
	17		421944023801	ЧОРНИЙ КАПУЧИНАТОР V3 S/SCR.NPR/H (3 ТРУБКОЮ) AS.CAPPUC.V3 SMR/H NER.
	18	 ПІД ЗАМОВЛЕННЯ	421944022461	BLK CAPPUC.CASING V3 SMR/H CORPO CAPPUC.V3 SMR/H NER.
	19	 ПІД ЗАМОВЛЕННЯ	421944023812	BLK CAPPUC.CASING COVER V5 SMR/H ASSY. AS.COP.CORPO CAPPUC.V5 SMR/H NER.
	20		NM01.028	O-RING 106 SILICONE OR 106 SILICONE
	21	 ПІД ЗАМОВЛЕННЯ	421941301121	BLK CAPPUC.CASING COVER RING SMR/H BLK CAPPUC.CASING COVER RING SMR/H
	22		421941301131	BLK CAPPUC.CASING SEAL SMR/H BLK CAPPUC.CASING SEAL SMR/H
	23		147922350	BLACK CONNECTOR 90° FOR SPHERIC.CAPPUC. BLACK CONNECTOR 90° FOR SPHERIC.CAPPUC.
	24		9972.045	SILICONE TUBE 3,5X6 L=350 MM DS TUBO SILICONE 3,5X6 L.350 MM
	25		12001622	SCREW TCB TORX B 3,5X9,5 SCHEET NIK SCREW TCB TORX B 3,5X9,5 SCHEET NIK
	26		17000257	BLACK.COFFEE DISPENSER SUPPORTRYL BLACK.COFFEE DISPENSER SUPPORT RYL



# Model Machine

MACSAE154

ROYAL GRANCREMA ЧЁРНАЯ

MACSAE154.T.0003

TAVOLA NR. 3 - ARTICOLO ROYAL GRANCREMA ЧЁРНАЯ

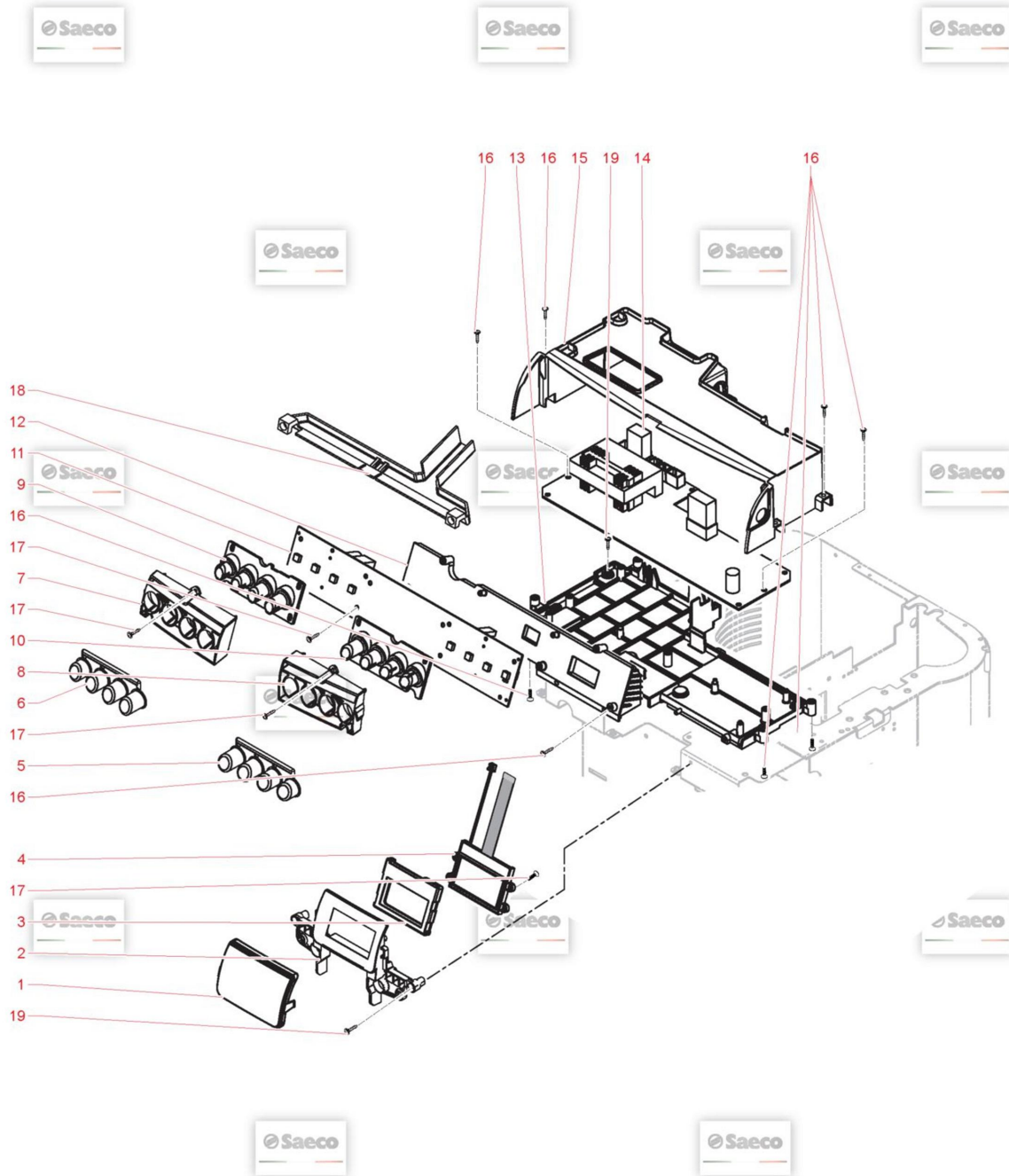

## Model Machine

MACSAE154

ROYAL GRANCREMA ЧЁРНАЯ

Web Pos. Foto Item - Replace by Description



Press - CTRL + CLICK go to item in a new window  
Натисніть - Ctrl + права кнопка миші щоб відкрити запчастину в новому вікні



1



17000269

СКЛО ДИСПЛЕЯ PHILIPS SAECO 996530068575  
TRANSP.GLASS FOR DISPLAY RYL



2



17000259

BLACK DISPLAY INSERT RYL  
BLACK DISPLAY INSERT RYL



3



17000271

BLACK DISPLAY SEAL RYL  
BLACK DISPLAY SEAL RYL



4



12001606

ДИСПЛЕЙ 160X80  
AMBER DISPLAY 160X80 0355DP RYL



5

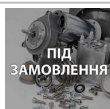

17001972

BLK RIGHT TOUCH PANEL COVER V2S/S.RYL/H  
BLK RIGHT TOUCH PANEL COVER V2 S/S.RYL/H



6



17001973

ЧОРНА ЛІВА КЛАВІАТУРА V2 S/S.RYL/H  
BLK LEFT TOUCH PANEL COVER V2 S/S.RYL/H



7

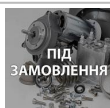

17000488

BLACK LEFT TOUCH PANEL SUPPORT RYL  
BLACK LEFT TOUCH PANEL SUPPORT RYL



8

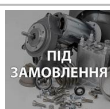

17000244

BLACK RIGHT TOUCH PANEL SUPPORT RYL  
BLACK RIGHT TOUCH PANEL SUPPORT RYL



9

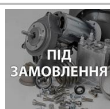

17000434

TRANSP.LEFT TOUCH PANEL RYL  
TRANSP.LEFT TOUCH PANEL RYL



10

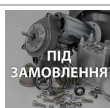

17000430

TRANSP.RIGHT TOUCH PANEL RYL  
TRANSP.RIGHT TOUCH PANEL RYL



11



11030792

CPU+SW RYL/H ASSY.  
CPU+SW RYL/H ASSY.



12



17000274

BLACK CPU BOARD SUPPORT RYL  
BLACK CPU BOARD SUPPORT RYL



13

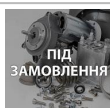

17000275

BLACK PWR BOARD SUPPORT RYL  
BLACK PWR BOARD SUPPORT RYL

## Model Machine

MACSAE154

ROYAL GRANCREMA ЧЁРНАЯ

	14		11030790	PWR BOARD RYL/H 230V <i>PWR BOARD RYL/H 230V</i>
	15		17000277	BLACK CPU-PWR BOARDS COVER RYL <i>BLACK CPU-PWR BOARDS COVER RYL</i>
	16		12000450	SCREW TCB TORX 10 3,5X12 PLAST.ZN-N <i>SCREW TCB TORX 10 3,5X12 PLAST.ZN-N</i>
	17		129913202	SCREW TCB TORX 10 3X8 PLAST.ZN-B <i>SCREW TCB TORX 10 3X8 PLAST.ZN-B</i>
	18		17001152	POWER BOARD PROTECTION RYL <i>POWER BOARD PROTECTION RYL</i>
	19		12001622	SCREW TCB TORX B 3,5X9,5 SCHEET NIK <i>SCREW TCB TORX B 3,5X9,5 SCHEET NIK</i>

# Model Machine

MACSAE154

ROYAL GRANCREMA ЧЁРНАЯ

MACSAE154.T.0004

TAVOLA NR. 4 - ARTICOLO ROYAL GRANCREMA ЧЁРНАЯ

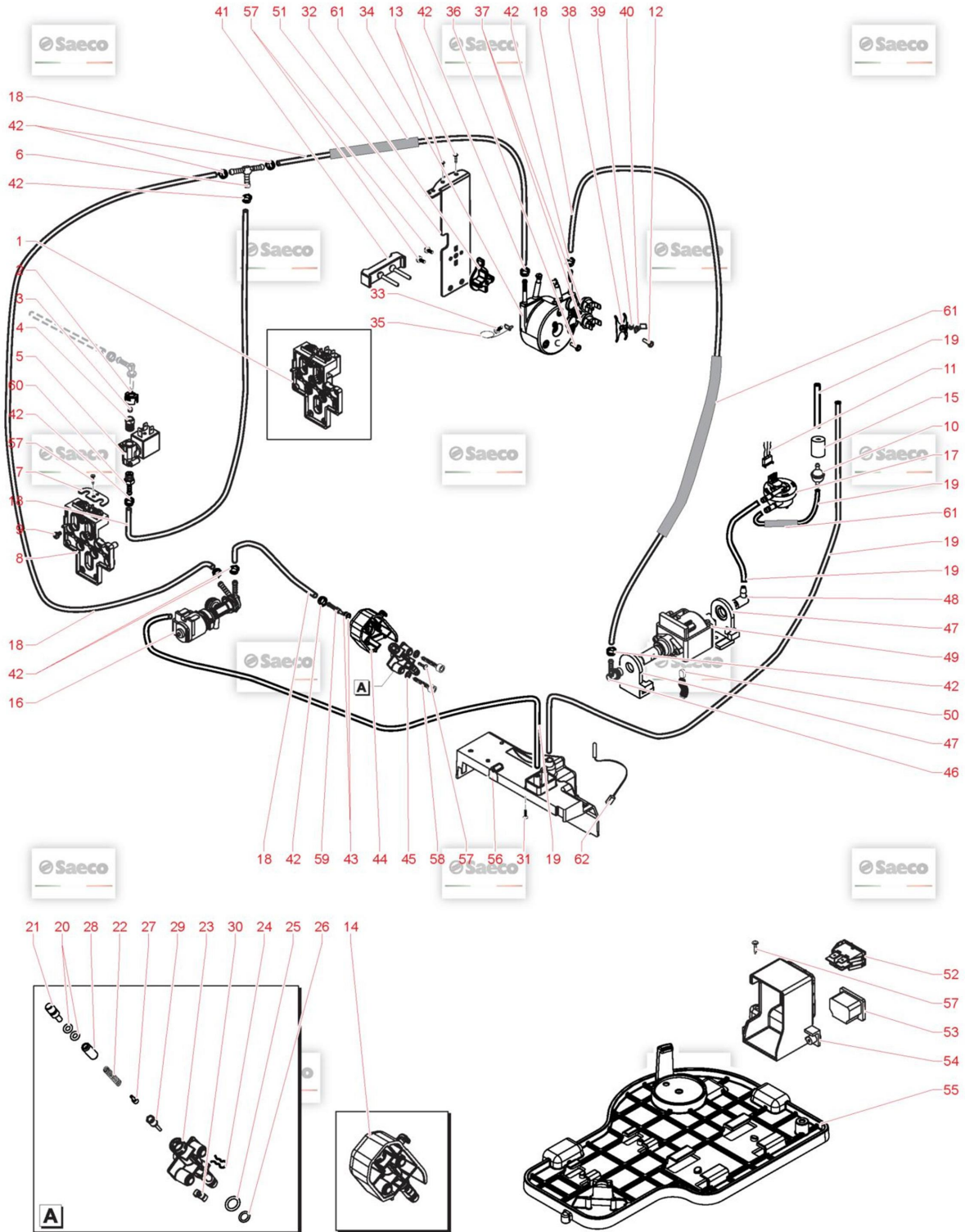

## Model Machine

MACSAE154

ROYAL GRANCREMA ЧЁРНАЯ

Web Pos. Foto Item - Replace by Description



Press - CTRL + CLICK go to item in a new window  
Натисніть - Ctrl + права кнопка миші щоб відкрити запчастину в новому вікні



1

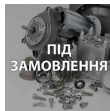

421944050311

TEA/BRASS ELECTROV.V3 RYL/H 24V ASSY.  
TEA/BRASS ELECTROV.V3 RYL/H 24V ASSY.



2



17001178

BLK EV 1/8"GAS.CONNECTOR V2 INSERT RYL  
BLK EV 1/8 GAS.CONNECTOR V2 INSERT RYL



3



17001909

RED EV CONNECTOR 1/8"GAS SEALV2 RYL  
RED EV CONNECTOR 1/8 GAS SEAL V2 RYL



4

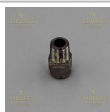

11027334

3'ЄДНАННЯ 1/8"GAS V2 RYL  
TEA/BRASS ELECTROV.CONNECT1/8"GAS V2 RYL



5



17001262

LFBASS 2W.EV 21JN1R4V20-X031  
LFBASS 2W.EV 21JN1RRV20-X005+LBV05024CU



6

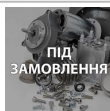

11007493

T CONNECTOR FOR BOILER P604  
T CONNECTOR FOR BOILER P604



7

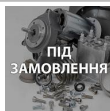

17000428

STEEL CONNECTORS FIXING PLATERYL  
STEEL CONNECTORS FIXING PLATE RYL



8

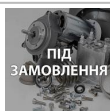

17000168

BLACK ELECTROV/CONNECTOR SUPP.RYL  
BLACK ELECTROV/CONNECTOR SUPP.RYL



9

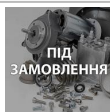

U043.012

SCREW TCB TORX 20 M4X6 ZN-B  
VITE TCBC M4,0X6 UNI 7687 Z



10



12001595

TRANSP/WHITE ASPIRATION FILTERMDS  
TRANSP/WHITE ASPIRATION FILTER MDS



11

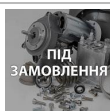

421946001551

6P.CONN.FLOWMETER V3 RYL UL ASSY.  
6P.CONN.FLOWMETER V3 RYL UL ASSY.



12

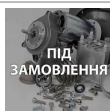

12001715

SCREW TCB TORX 20 M4X8 AUTOFORMING ZN-B  
SCREW TCB TORX 20 M4X8 AUTOFORMING ZN-B



13





























12001622

SCREW TCB TORX B 3,5X9,5 SCHEET NIK  
SCREW TCB TORX B 3,5X9,5 SCHEET NIK

## Model Machine

MACSAE154

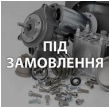























ROYAL GRANCREMA ЧЁРНАЯ

	14		11025744	TEA/BRASS HOT WATER PIN RYL ASSY. <i>TEA/BRASS HOT WATER PIN RYL ASSY.</i>
	15		147756562	BLK PROTECTION FOR FOLK SPRINGTUBE D=4 <i>BLK PROTECTION FOR FOLK SPRING TUBE D=4</i>
	16		11031116	BLOWDOWN VALVE V3 RYL 24V ASSY. <i>BLOWDOWN VALVE V3 RYL 24V ASSY.</i>
	17		NV99.099	TURBINE D=1,2 ASSY. <i>TURBINA DIGMESA FHKSC 1,2 ARNITE OC</i>
	18		16000380	5X8,9 SILICONE TUBE IN ROLL <i>5X8,9 SILICONE TUBE IN ROLL</i>
	19		JS01.022	SILICONE TUBE 5X10 60SH IN ROLL <i>SILICONE TUBE 5X10 60SH IN ROLL</i>
	20		140326662	OR ORM 0040-20 SILICONE <i>OR METRIC 0040-20 IN SILICONE</i>
	21		11026413	TEA/BRASS HOT WATER PIN PLUG RYL <i>TEA/BRASS HOT WATER PIN PLUG RYL</i>
	22		9011.132	SS SPRING FOR PIN <i>MOLLA X SPILLO</i>
	23		9161.434	HOT WATER PIN <i>PERNO CALDAIA MAGIC,ROYAL SAECO</i>
	24		9011.144	SS FORK FOR TUBE D=4 <i>FORCELLA X TUBO D.4</i>
	25		NM01.035	OR ORM 0090-20 SILICONE <i>OR ORM 0090-20 SILICONE</i>
	26		NM01.057	OR ORM 0050-20 IN SILICONE <i>OR ORM 0050-20 IN SILICONE</i>
	27		11009013	TEA/BRASS PIN FOR PISTON L=10 <i>TEA/BRASS PIN FOR PISTON L=10</i>

## Model Machine

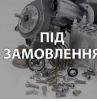
MACSAE154











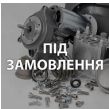



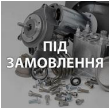



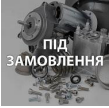





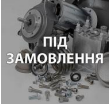

ROYAL GRANCREMA ЧЁРНАЯ

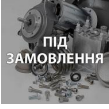
	28		11009012	TEA/BRASS BOILER PIN BUSH <i>TEA/BRASS BOILER PIN BUSH</i>
	29		11009019	TEA/BRASS PISTON L=20,9 ASSY. <i>TEA/BRASS PISTON L=20,9 ASSY.</i>
	30		11005099	NATURAL CURSOR V2 FOR BOILER P119 <i>NATURAL CURSOR V2 FOR BOILER P119</i>
	31		129913902	SCREW TCB TORX 10 3X12 PLAST.ZN-B <i>SCREW TCB TORX 10 3X12 PLAST.ZN-B</i>
	32	 ПІД ЗАМОВЛЕННЯ	11023282	BLACK SLIM TUB.BOILERS SUPPORTMYB9 <i>BLACK SLIM TUB.BOILERS SUPPORT MYB9</i>
	33		129573402	SCREW TAPT M4X10 DIN 7985 GALV <i>SCREW TAPT M4X10 DIN 7985 GALV</i>
	34	 ПІД ЗАМОВЛЕННЯ	11031208	HP/SLIM TUB.BOILER MDS/B 1900W230V ASSY <i>HP/SLIM TUB.BOILER MDS/B 1900W 230V ASSY</i>
	35		190800100	ТЕМПЕРАТУРНИЙ СЕНСОП NTC UL L=280MM <i>TEMPERATURE SENSOR NTC UL L=280MM</i>
	36	 ПІД ЗАМОВЛЕННЯ	12001280	SCREW TSP TORX 10 5X20 PLAST.ZN-B <i>SCREW TSP TORX 10 5X20 PLAST.ZN-B</i>
	37		12001033	ТЕРМОСТАТ 190°C БОЙЛЕРА ДЛЯ КОФЕВАРОК PHILIPS SAECO 12001033 <i>THERMOSTAT ONE SHOT 190°</i>
	38	 ПІД ЗАМОВЛЕННЯ	11001751	TUB.BOILER V3 UPPER THERM.FIXING SPRING <i>TUB.BOILER V3 UPPER THERM.FIXING SPRING</i>
	39		128310402	GALV.WASHER UNI 8842 A4 <i>GALV.WASHER UNI 8842 A4</i>
	40		124390520	BRASS BENT FASTON 45° 6,3X0,8 <i>BRASS BENT FASTON 45° 6,3X0,8</i>

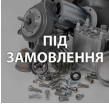
## Model Machine

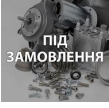
MACSAE154

ROYAL GRANCREMA ЧЁРНАЯ











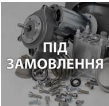

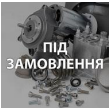



	41		17000471	BLACK BOILER ANTIVIBRATION RYL <i>BLACK BOILER ANTIVIBRATION RYL</i>
	42		12000892	ЗАЖИМ D.9,5 16700004 <i>OETIKER CLAMP D=9,5 16700004 (L250)</i>
	43		140328059	OR 2015 SILICONE PTFE/FDA <i>OR 2015 SILICONE PTFE/FDA</i>
	44		17000156	BLACK HOT WATER PIN SUPPORT RYL <i>BLACK HOT WATER PIN SUPPORT RYL</i>
	45		128310521	WASHER UNI 8842 A5 SS <i>WASHER UNI 8842 A5 SS</i>
	46		11001054	СОЕДИНИТЕЛЬНЫЙ УГОЛОК 90° К НАСОСУ P0049/B PHILIPS SAECO 996... <i>BLK PUMP OUTLET 90° CONNECTOR P0049/B</i>
	47		11022857	BLACK PUMP SUPPORT GMYB <i>BLACK PUMP SUPPORT GMYB</i>
	48		147920150	90° INLET PUMP CONNECTOR <i>RACCORDO A 90° IN SANTOPRENE</i>
	49		12000140	PUMP 230V-50HZ <i>ULKA PUMP EP5/S GW 230V-50HZ</i>
	50		17800202	2POLES CONNECTOR COFFEE PUMP RYL UL <i>2POLES CONNECTOR COFFEE PUMP RYL UL</i>
	51		17001971	STEEL COFFEE TUBOL.BOILER SUPPORT RYL/H <i>STEEL COFFEE TUBOL.BOILER SUPPORT RYL/H</i>
	52		NE03.038	BIPOLAR SWITCH FUSIT C1250AR <i>BIPOLAR SWITCH FUSIT C1250AR</i>
	53		12001883	CUP SOCKET V3 EN 60320 C 13 <i>CUP SOCKET V3 EN 60320 C 13</i>
	54		17000162	BLACK SOCKET-SWITCH SUPPORT RYL <i>BLACK SOCKET-SWITCH SUPPORT RYL</i>



## Model Machine

MACSAE154

ROYAL GRANCREMA ЧЁРНАЯ

	55		<b>17000160</b>	BLACK COMPONENTS SUPPORT RYL <i>BLACK COMPONENTS SUPPORT RYL</i>
	56		<b>17000165</b>	BLACK DRIP TRAY PROTECTION RYL <i>BLACK DRIP TRAY PROTECTION RYL</i>
	57		<b>12000450</b>	SCREW TCBR TORX 10 3,5X12 PLAST.ZN-N <i>SCREW TCBR TORX 10 3,5X12 PLAST.ZN-N</i>
	58		<b>11003555</b>	GALVANIZED SELF-TAPPING SCREW4,8X32 <i>GALVANIZED SELF-TAPPING SCREW 4,8X32</i>
	59		<b>11000750</b>	TEA/BRASS CONNECTOR FOR SILICONE TUBE <i>TEA/BRASS CONNECTOR FOR SILICONE TUBE</i>
	60		<b>11006304</b>	TEA/BRASS CONNECTOR FOR ALUM.BOILER <i>TEA/BRASS CONNECTOR FOR ALUM.BOILER</i>
	61		<b>16000540</b>	TRANSPAR.11X12,8 SILICONE TUBEIN ROLL <i>TRANSPAR.11X12,8 SILICONE TUBE IN ROLL</i>
	62		<b>17800442</b>	2POLES CONNECT.SENSOR REED DUMP BOX CST <i>2POLES CONNECT.SENSOR REED DUMP BOX CST</i>
	10001		<b>11031097</b>	COFFEE TUB.BOILER 230V RYL/H ASSY. <i>COFFEE TUB.BOILER 230V RYL/H ASSY.</i>

# Model Machine

MACSAE154

ROYAL GRANCREMA ЧЁРНАЯ

MACSAE154.T.0005



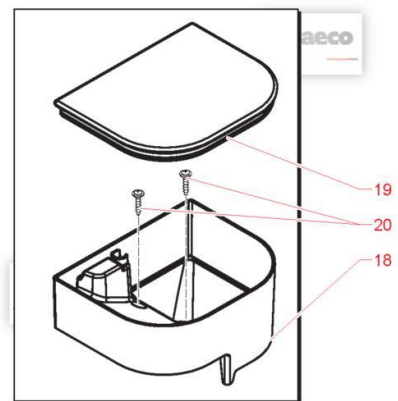
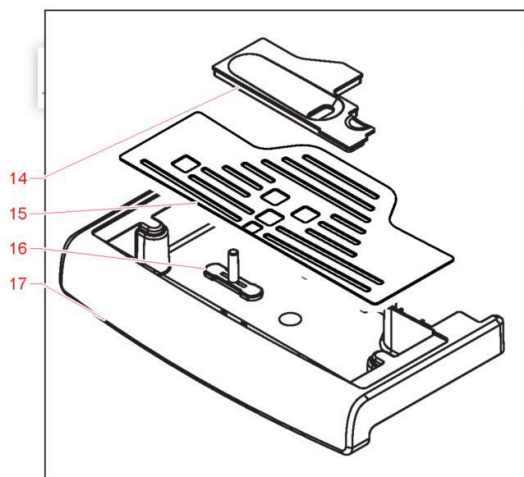
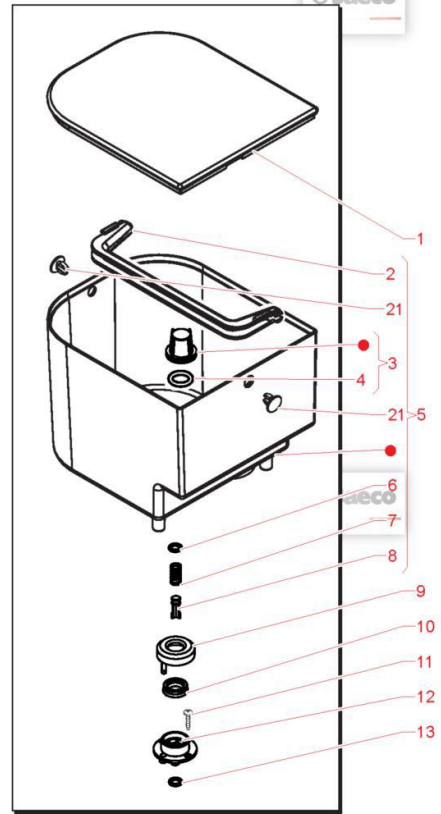























TAVOLA NR. 5 - ARTICOLO ROYAL GRANCREMA ЧЁРНАЯ



## Model Machine

MACSAE154

ROYAL GRANCREMA ЧЁРНАЯ

Web	Pos.	Foto	Item - Replace by	Description
				<i>Press - CTRL + CLICK go to item in a new window Натисніть - Ctrl + права кнопка миші щоб відкрити запчастину в новому вікні</i>
	1		11031090	TXO/BLK WATER CONTAINER LID RYL COP.CONT.ACQ.RYL VERN.NER/TXO
	2		17000174	BLACK WATER CONTAINER HANDLE RYL BLACK WATER CONTAINER HANDLE RYL
	3		224640200	БІЛИЙ ПЛАСТИКОВИЙ ФІЛЬТР У КОНТЕЙНЕР ВОДИ SAECO 996530029115 EXTERNAL FILTER FOR WATER CONTAINER ASSY
	4		140328461	ПРОКЛАДКА O-RING 0190-10 ДЛЯ КОФЕМАШИНЫ PHILIPS SAECO 99653... OR METRICO 0190-10 IN EPDM NUOVO PREZZO 0,13
	5		11025725	NAT/GREY WATER CONTAINER S/SCR.RYL ASSY. AS.CONT.ACQ.RYL GRI/NAT.SER.
	6		140324362	OR ORM 0060-30 SILICONE OR METRIC 0060-30 IN SILICONE
	7		126764718	SS WATER CONTAINER VALVE SPRING SS WATER CONTAINER VALVE SPRING
	8		147660562	GREY PISTON FOR WATER CONTAINER VALVE GREY PISTON FOR WATER CONTAINER VALVE
	9		0701.031.150	GREY WATER VALVE GACO DIM 14 SEAL COVER SEAL COVER GREY
	10		145842900	NBR WATER CONT.VALVE GACO DIM14 SEAL NBR WATER CONT.VALVE GACO DIM14 SEAL
	11		12000895	SCREW TSP TORX 10 3X10 PLAST.SS SCREW TSP TORX 10 3X10 PLAST.SS
	12		0701.014.150	GREY WATER VALVE GACO DIM 14 SEAL CONT. GREY WATER VALVE GACO DIM 14 SEAL CONT.
	13		140320461	OR ORM 0080-20 TERMOIL OR ORM 0080-20 IN TERMOIL

## Model Machine

MACSAE154

ROYAL GRANCREMA ЧЁРНАЯ



14



17000982

BLACK DRIP TRAY COVER RYL  
*BLACK DRIP TRAY COVER RYL*



15



17000721

BA/SS DRIP TRAY GRATE RYL/H  
*GRIGLIA VASCA REC.ACQ.RYL/H INOX/BA*



16



17000991

RED FLOAT V2 FOR DRIP TRAY RYL  
*RED FLOAT V2 FOR DRIP TRAY RYL*



17



11031093

TXO/BLK DRIP TRAY RYL ASSY.  
*AS.VASCA REC.ACQ.RYL VERN.NER/TXO*



18



17000188

NAT/GREY BEAN CONTAINER RYL  
*NAT/GREY BEAN CONTAINER RYL*



19



11031089

TXO/BLK BEAN COF.CONT.LID RYL ASSY.  
*AS.COP.CONT.CAF.GRA.RYL VERN.NER/TXO*



20

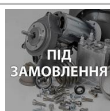

12001431

SCREW TCB TORX 10 3X12 PLAST.SS  
*SCREW TCB TORX 10 3X12 PLAST.SS*



21



17001255

ЗАТИЧКА 1 ШТ  
*BLACK PLUG FOR WATER CONTAIN.HANDLE RYL*

# Model Machine

MACSAE154

ROYAL GRANCREMA ЧЁРНАЯ

MACSAE154.T.0006

TAVOLA NR. 6 - ARTICOLO ROYAL GRANCREMA ЧЁРНАЯ

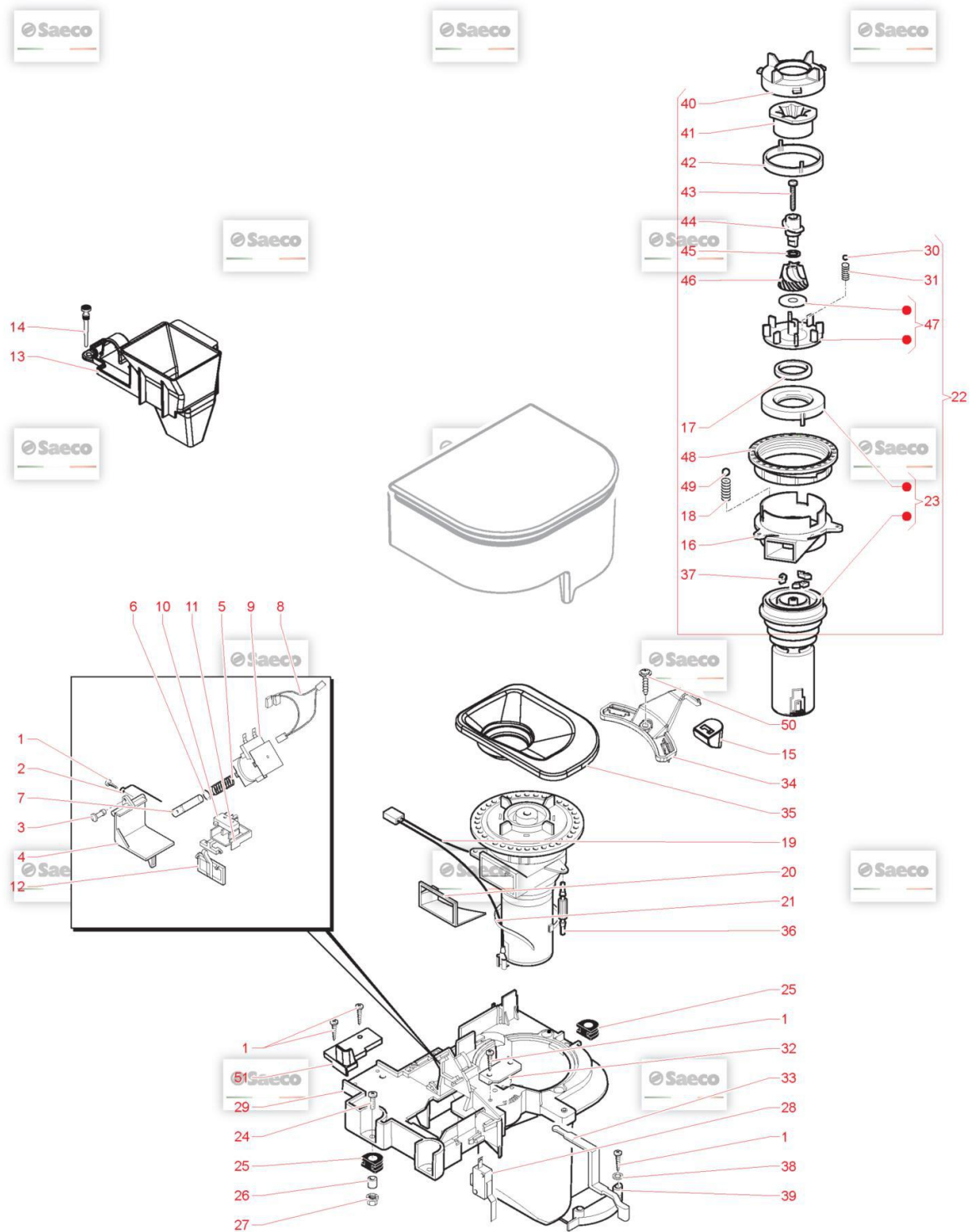



























## Model Machine

MACSAE154

ROYAL GRANCREMA ЧЁРНАЯ















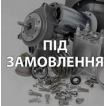





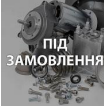



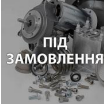

Web Pos. Foto Item - Replace by Description

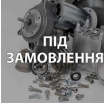
 <span style="color: red; font-weight: bold;">Press - CTRL + CLICK go to item in a new window</span> <span style="color: red; font-weight: bold;">Натисніть - Ctrl + права кнопка миші щоб відкрити запчастину в новому вікні</span>				
	1		<b>129913902</b>	SCREW TCB TORX 10 3X12 PLAST.ZN-B SCREW TCB TORX 10 3X12 PLAST.ZN-B
	2		<b>9161.048</b>	STEEL GROUND COF.DOSER SCRAPERROD ASTA RASATORE
	3		<b>9161.076.150</b>	GREY GROUND COF.DOSER DOOR PIN PERNO SPORTELLO DOSATORE GRIGIO
	4		<b>9161.074.150</b>	GREY GROUND COFFE DOSER DOOR SPORTELLO DOSATORE GRIGIO
	5		<b>126764818</b>	ПРУЖИНА ЕЛЕКТРОМАГНІТНОГО ДОЗАТОРА ЗЕРНА MAGIC SAECO 916... SPRING ELECTROM.BEAN DOSER MAGIC
	6		<b>U701.003</b>	SNAP RING 7 UNI 7434 ANELLO ELASTICO 7 UNI 7434
	7		<b>9161.041</b>	STEEL GROUND COF.DOSER ELECTROMAGN.CORE NUCLEO ELETTRROMAGNETE DOSATORE
	8	 ПІД ЗАМОВЛЕННЯ	<b>421946000541</b>	4P.CONN.COIL+DOSER MICRO V2 RYL UL ASSY. 4P.CONN.COIL+DOSER MICRO V2 RYL UL ASSY.
	9		<b>11025734</b>	DOSER COIL FOR SUPERAUTOM.24VDC ASSY. DOSER COIL FOR SUPERAUTOM.24V DC ASSY.
	10		<b>NE05.017</b>	MICROSWITCH MICROSWITCH NE05.017
	11		<b>9161.072.150</b>	GREY MICRO SUPP.CURSOR GROUNDCOF.DOSER MICRO SUPPORT CURSOR GREY
	12		<b>9161.073.150</b>	GREY GROUND COF.DOSE CONTROL COMPENSATOR DOSE CONTROL COMPENSATOR GREY
	13		<b>17000176</b>	BLACK HOPPER FOR POWDER COFFEERYL BLACK HOPPER FOR POWDER COFFEE RYL

## Model Machine

MACSAE154



















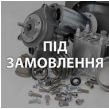



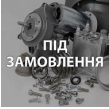

ROYAL GRANCREMA ЧЁРНАЯ

	14		9161.082	RUBBER COUPLER <i>AGGANCIO IN GOMMA</i>
	15		421941300291	BLK/SIL.GRIND.ADJUS.LEVER HANDGRIP RYL <i>BLK/SIL.GRIND.ADJUS.LEVER HANDGRIP RYL</i>
	16		9141.080	ТРИМАЧ ДВИГУНА КАВОМОЛКИ ДЛЯ КАВОВАРКИ SAECO 9141.080 <i>SUPPORTO MOTORE</i>
	17		140360200	FELT RING 40X34X5 <i>ANELLO IN FELTRO DE=40 DI=34</i>
	18		126770117	NEW SPRING SPHERE D=3,2 MOTORMAGIG <i>MOLLA NEW X SFERA D=3,2 MOTORE MAGIC</i>
	19		421946000531	2P.CONN.GRINDER MOTOR V2 RYL UL ASSY. <i>2P.CONN.GRINDER MOTOR V2 RYL UL ASSY.</i>
	20		1505.014	COFFEEGRINDER SEAL <i>GUARNIZIONE DOSATORE</i>
	21		144320200	SELF LOCK STRIP W=2.6 L=200 <i>SELF LOCK STRIP W=2.6 L=200</i>
	22		9140.036.00A	КАВОМОЛКА В ЗБОРИ 230V PHILIPS SAECO 996530065687 <i>COFFEE GRINDER STD 230V ASSY.</i>
	23		0301.R10.00A	SPARE MOTOR UNIT MC 230V <i>GRUPPO RICAMBIO MOTORE MC 230 V</i>
	24		U043.004	ZN-B TCB TORX 20 M4X16 ZN-B <i>VITE TCBC M4,0X16 UNI 7687 ZNP</i>
	25		9991.005	RUBBER FOR COFFEE GRINDER <i>GOMMINO X MACINA CAFFE</i>
	26		9141.003	SPACER FOR RUBBER <i>SPACER FOR RUBBER</i>
	27		U324.006	ШАЙБА М4 <i>NUT M4 FLANGED INDENTED BASE</i>

## Model Machine

MACSAE154

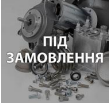
ROYAL GRANCREMA ЧЁРНАЯ

	28		12001605	МИКРИК MICROSWITCH
	29		9161.365.150	GREY PLATE COFFEEGRINDER MAGIC/ROYAL PIASTRA X MACINACAFFE' GRIGIO/7016
	30		128610521	STAIL.STEEL AISI 304 SPHERE D=5,5MM SFERA D=5,5MM ACCIAIO INOX A
	31		126765517	STEEL SPRING SPHERE D=5,5 MOTOR MAGIC MOLLA ACC.X SFERA D=5,5 MOTO
	32		9161.097.150	GREY GROUND COF.DOSER LEVER FIXING PLATE LEVER FIXING PLATE GREY
	33		0313.003.150	7016/GREY GROUND COF.DOSER ADJUSTM.LEVER LEVA DI REGOLAZIONE GRIGIO R
	34		17000198	BLACK GRINDING ADJUSTM.LEVER RYL BLACK GRINDING ADJUSTM.LEVER RYL
	35		17000238	COFFEE GRINDER SOUNDPROOFING COVER RYL COFFEE GRINDER SOUNDPROOFING COVER RYL
	36		9991.103	АМОТИЗАТОР ДЛЯ КОФЕМОЛКИ КОФЕМАШИН PHILIPS SAECO 996530... AMMORTIZZATORE PER MACINACAFE
	37		140230400	SHOCK ABS .CONICAL GRINDER SUPP.MAGIC AMMORTIZ.X SUPPOR.MACIN.CONI
	38		U201.001	PLAIN WASHER 3,2X9 DIN 7349 GALV. PLAIN WASHER 3,2X9 DIN 7349 GALV.
	39		9161.403.150	GREY COFFEE DOSE ADJUSTAMENT SCALE GREY COFFEE DOSE ADJUSTAMENT SCALE
	40		149186150	BLACK UPPER GRINDER SUPPORT MAGIC SUPPORT.NER.X MACINA SUPERIO



## Model Machine

MACSAE154

ROYAL GRANCREMA ЧЁРНАЯ



42



142844550

UPPER GRINDER COVER COFFEE GRIND. MAGIC  
*UPPER GRINDER COVER COFFEE GRIND. MAGIC*



43

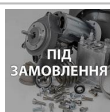

129931002

TORX SCREW T10 TCB 3,5X40 SX ZNG  
*TORX SCREW T10 TCB 3,5X40 SX ZNG*



44



147470763

BLK INCREASE SCREW PIN COF.GRINDER MAGIC  
*PERNO INCREM.A VITE X MACINA*



45



U201.002

PLAIN WASHER 10X16X0,2DIN 988GAL  
*ROSETTA PIANA 10X16X0,2DIN*



46

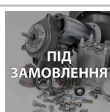

226473500

KIT TECNA GRINDERS  
*KIT TECNA GRINDERS*



47

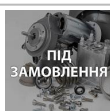

149188750

CONICAL GRIND. SUPP. + RING MAGIC  
*CONICAL GRIND. SUPP. + RING MAGIC*



48



146570950

RING NUT FOR GRINDING ADJUSTMENT MAGIC  
*GHIERA NERA REGOLAZ.MACINATU*



49



128610421

STAIL.STELL AISI 304 SPHERE D=3,2MM  
*SFERA D=3,2MM ACCIAIO INOX A*



50



12000450

SCREW TCBR TORX 10 3,5X12 PLAST.ZN-N  
*SCREW TCBR TORX 10 3,5X12 PLAST.ZN-N*



51

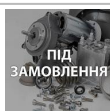

17001155

GREY COVER FOR DOSER HOLE RYL  
*GREY COVER FOR DOSER HOLE RYL*

# Model Machine

MACSAE154

ROYAL GRANCREMA ЧЁРНАЯ

MACSAE154.T.0007



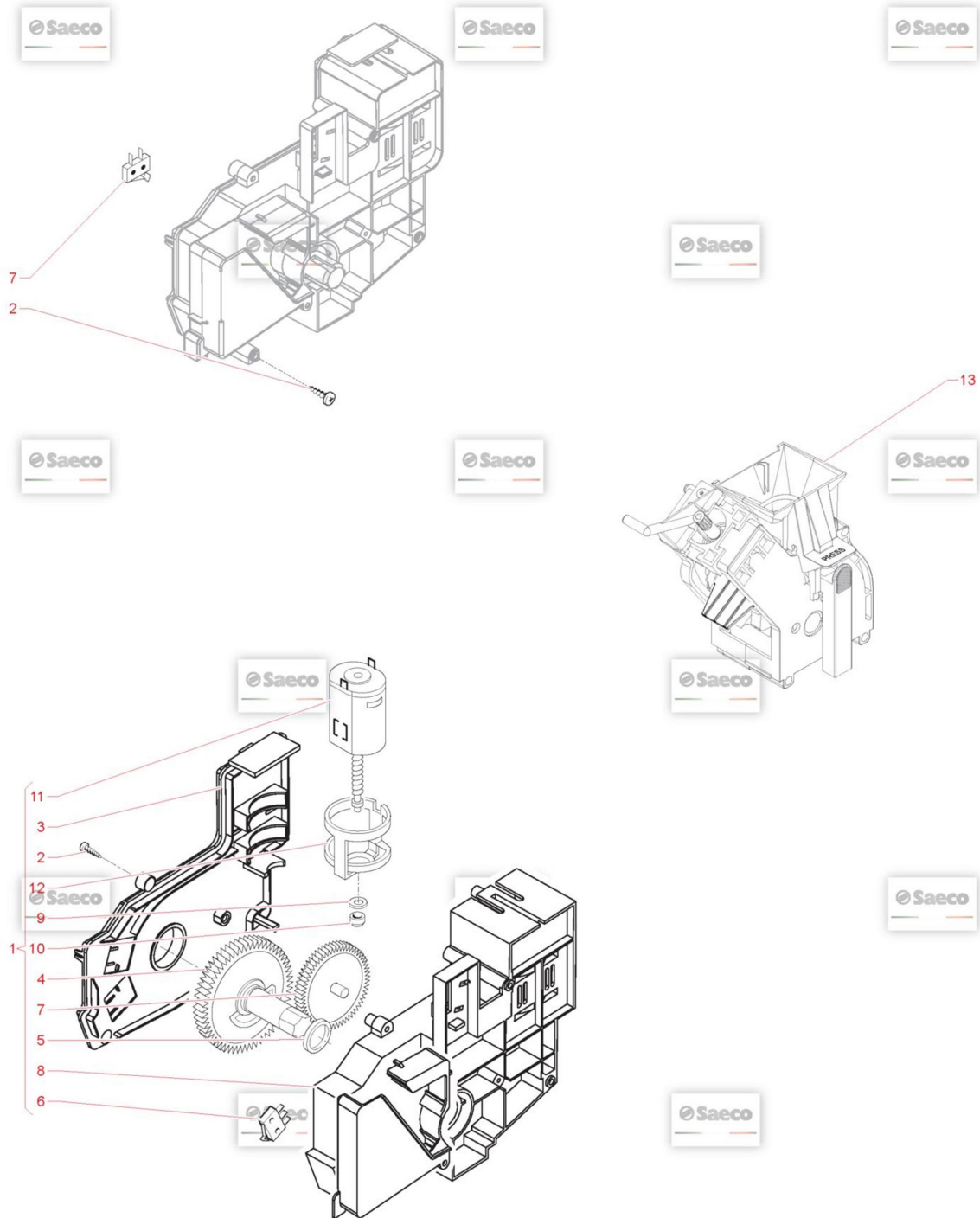









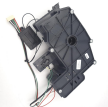



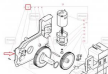









TAVOLA NR. 7 - ARTICOLO ROYAL GRANCREMA ЧЁРНАЯ



## Model Machine

MACSAE154

ROYAL GRANCREMA ЧЁРНАЯ

Web	Pos.	Foto	Item - Replace by	Description
				<i>Press - CTRL + CLICK go to item in a new window Натисніть - Ctrl + права кнопка миші щоб відкрити запчастину в новому вікні</i>
	1		11025736	РЕДУКТОР ВЗБОРИ PHILIPS SAECO 996530068554 RATIOMOTOR RYL ASSY.
	2		129670202	TCB PANELVIT SCREW 3,5X16 TESTA D=8 ZNP TCB PANELVIT SCREW 3,5X16 TESTA D=8 ZNP
	3		17000719	GREY RATIOMOTOR LID RYL GREY RATIOMOTOR LID RYL
	4		11007137	BLACK GEAR Z=77 V2 FOR RATIOMOTOR P124 BLACK GEAR Z=77 V2 FOR RATIOMOTOR P124
	5		9161.368	MYLAR WASHER FOR RATIOMOTOR RONDELLA MYLAR X MOTORIDUTTORE
	6		NE05.038	MICROSWITCH 30V 0.3A MICROINTERRUTTORE
	7		146002800	GREY GEAR Z=13/90 FOR RATIOMOTOR P124 GREY GEAR Z=13/90 FOR RATIOMOTOR P124
	8		11026258	GREY RATIOMOTOR CASING WITH TUBE ASSY. GREY RATIOMOTOR CASING WITH TUBE ASSY.
	9		148380200	BAKELIZZATE WASHER D=5,5 BAKELIZZATE WASHER D=5,5
	10		9121.046	BRONZE SINTERED BUSH FOR MOTORRATIOMOT. BRONZE SINTERED BUSH FOR MOTOR RATIOMOT.
	11		11005214	MOTOR FOR RATIOMOTOR ASSY. MOTOR FOR RATIOMOTOR P124 ASSY
	12		9121.044	ANTIVIBRATION FOR MOTOR ANTIVIBRANTE X MOTORE
	13		11031584	BLACK BREW UNIT BLACK BREW UNIT RYL



# Model Machine

MACSAE154

ROYAL GRANCREMA ЧЁРНАЯ

MACSAE154.T.0008



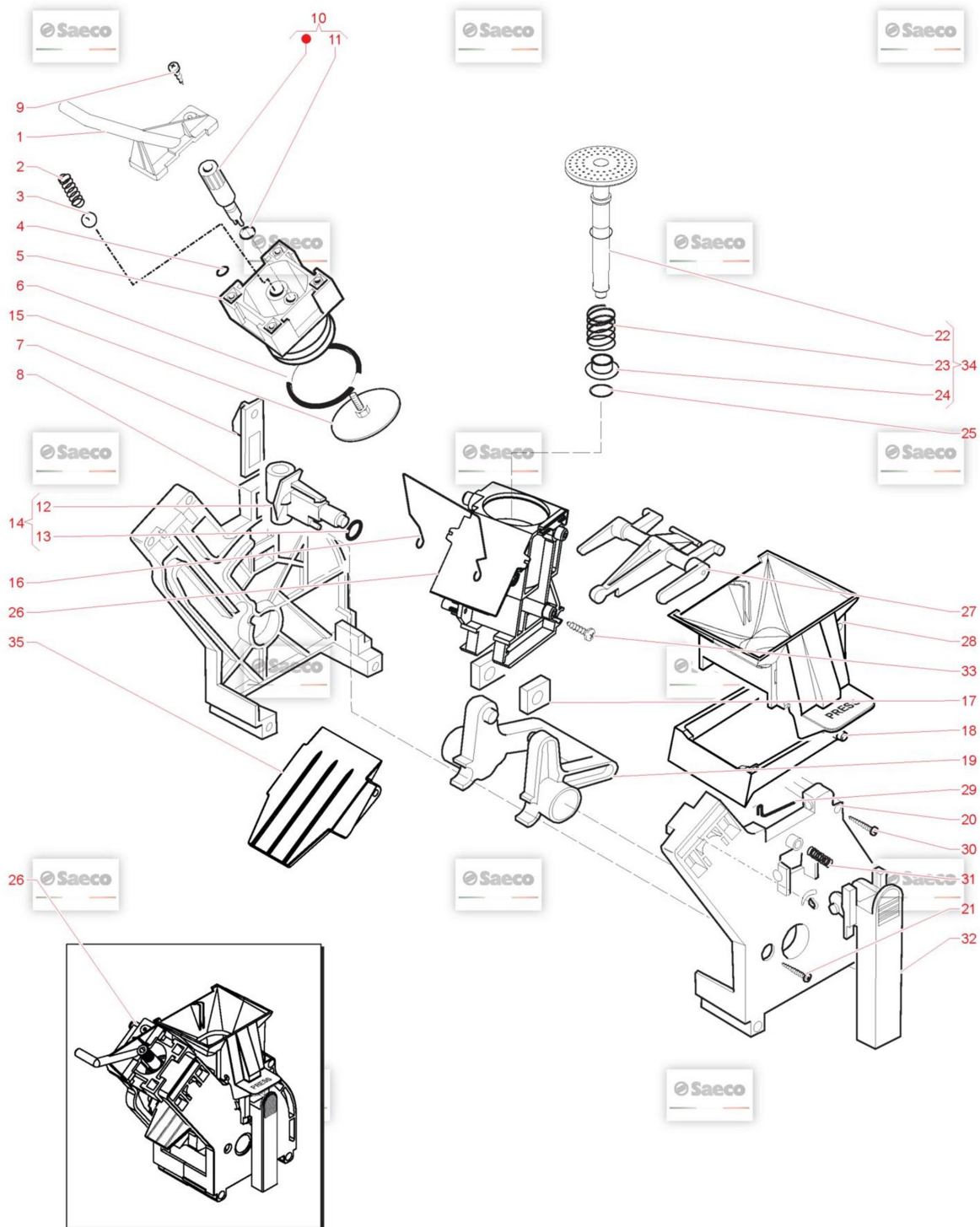























TAVOLA NR. 8 - ARTICOLO ROYAL GRANCREMA ЧЁРНАЯ



## Model Machine

MACSAE154





























ROYAL GRANCREMA ЧЁРНАЯ

Web	Pos.	Foto	Item - Replace by	Description
				<i>Press - CTRL + CLICK go to item in a new window Натисніть - Ctrl + права кнопка миші щоб відкрити запчастину в новому вікні</i>
	1		11003789	BLACK COFF.OUTLET SLEEVE BREWUNIT ROYAL <i>BLACK COFF.OUTLET SLEEVE BREW UNIT ROYAL,AULIKA MAGIC SAECO</i>
	2		9161.222	SS.CONICAL SPRING <i>MOLLA CONICA</i>
	3		421944034451	BOROSILICATE SPHERE D.5 MM <i>BOROSILICATE SPHERE D.5</i>
	4		11021334	BLK COUNTERPISTON SEAL DE=11 DI=8 SP=1,4 <i>BLK COUNTERPISTON SEAL DE=11 DI=8 SP=1,4</i>
	5		11003796	BLACK BREW UNIT COUNTERPISTONM5000 <i>BLACK BREW UNIT COUNTERPISTON M5000</i>
	6		NM01.044	OR ORM 0320-40 SILICONE PTFE/FDA <i>OR ORM 0320-40 SILICONE PTFE</i>
	7		11004114	BLACK BREW UNIT COUPLING PLATE <i>BLACK BREW UNIT COUPLING PLATE</i>
	8		421941158532	BLACK BREW UNIT REAR PLATE V2M5000 <i>BLACK BREW UNIT REAR PLATE V2 M5000</i>
	9		U140.019	SCREW TCB TORX 10 3X16 PLAST SS <i>PANELVIT TCB 3,0X16 DIN 7505</i>
	10		227470150	PIN BLACK ASS.FOR PERCOLATOR <i>PIN BLACK ASS.FOR PERCOLATOR</i>
	11		140324461	OR ORM 0060-20 TERMOIL <i>OR ORM 0060-20 IN TERMOIL</i>
	12		9161.064.050	BLACK WATER INLET SLEEVE BREWUNIT ROYAL <i>BLACK WATER INLET SLEEVE BREW UNIT ROYAL</i>
	13		NM02.007	OR 2025 IN TERMOIL <i>OR 2025 TERMOIL</i>

## Model Machine

MACSAE154

















ROYAL GRANCREMA ЧЁРНАЯ

	14		<b>20000440</b>	BLACK WATER INLET SLEEVE BREWUNIT ASSY. <i>BLACK WATER INLET SLEEVE BREW UNIT ASSY.</i>
	15		<b>9160.075</b>	PERCOLATOR DE=35,8 ELFO ASSY. <i>PERCOLATOR DE=35,8 ELFO ASSY.</i>
	16		<b>11001556</b>	SS BREW UNIT SPRING H=49 SMART <i>SS BREW UNIT SPRING H=49 SMART</i>
	17		<b>9161.094.050</b>	BLACK BREW UNIT DRILLED BLOCK <i>BLACK BREW UNIT DRILLED BLOCK</i>
	18		<b>11004161</b>	BLACK SCRAPER FOR BREW UNIT M5000 <i>BLACK SCRAPER FOR BREW UNIT M5000</i>
	19		<b>9161.066.050</b>	BLACK BREW UNIT ELBOW SHAFT M5000 <i>BLACK BREW UNIT ELBOW SHAFT M5000</i>
	20	 ПІД ЗАМОВЛЕННЯ	<b>11003793</b>	BLACK BREW UNIT FRONT PLATE M5000 <i>BLACK BREW UNIT FRONT PLATE M5000</i>
	21		<b>12000550</b>	CAMOPI3 TCB TORX 10 3X25 PLAST.SS <i>SCREW TCB TORX 10 3X25 PLAST.SS</i>
	22	 ПІД ЗАМОВЛЕННЯ	<b>11003077</b>	BLK BREW UNIT INTEGRAL PISTON8GR.ASSY. <i>BLK BREW UNIT INTEGRAL PISTON 8GR.ASSY.</i>
	23		<b>9161.198</b>	SS.8GR.BREW UNIT PISTON SPRING <i>SS.8GR.BREW UNIT PISTON SPRING</i>
	24		<b>9161.191</b>	WHITE 8GR.-12GR.BREW UNIT PISTON BUSH <i>BOCCOLA X PISTONE NEUTRO</i>
	25		<b>NM02.018</b>	OR ORM 0090-25 TERMOIL <i>OR ORM 0090-25 TERMOIL</i>
	26		<b>421944014611</b>	BLK COF.CONTAIN.BREW UNIT V2 M5000 ASSY. <i>BLK COF.CONTAIN.BREW UNIT V2 M5000 ASSY.</i>
	27		<b>11003078</b>	BLACK CONNECTING ROD BREW UNIT 8GR. <i>BLACK CONNECTING ROD BREW UNIT 8GR.</i>

## Model Machine

MACSAE154

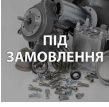
ROYAL GRANCREMA ЧЁРНАЯ

	28		11003795	BLACK HOPPER COFF.BREW UNIT S/SCR.M5000 <i>BLACK HOPPER COFF.BREW UNIT S/SCR.M5000</i>
	29		9161.046	ПРУЖИНА ВОРОНКИ ЗАВАРОЧНОГО БЛОКА ДЛЯ КОФЕМАШИН PHILIPS ... <i>MOLLA X RASATORE GRUPPO</i>
	30		12000897	SCREW TCB TORX 10 3,5X20 PLAST.SS <i>SCREW TCB TORX 10 3,5X20 PLAST.SS</i>
	31		9161.045	SS BREW UNIT HANDGRIP SPRING M5000 <i>MOLLA X IMPUGNATURA GRUPPO</i>
	32		11003791	BLACK BREW UNIT HANDGRIP M5000 <i>BLACK BREW UNIT HANDGRIP M5000</i>
	33		129912521	SCREW TCBR TORX 10 3,5X14 PLAST.SS <i>SCREW TCBR TORX 10 3,5X14 PLAST.SS</i>
	34		11023086	BLK 8GR.BREW UNIT NTEGR.PISTONGEN.ASSY. <i>BLK 8GR.BREW UNIT NTEGR.PISTON GEN.ASSY.</i>
	35		17000663	BLACK BREW UNIT CONVEYOR SLIDEL=76,8 <i>BLACK BREW UNIT CONVEYOR SLIDE L=76,8</i>
	36		11031584	BLACK BREW UNIT <i>BLACK BREW UNIT RYL</i>