

Model Machine

MACSAE018

SAECO ROYAL COFFEE BAR

MACSAE018.T.0001



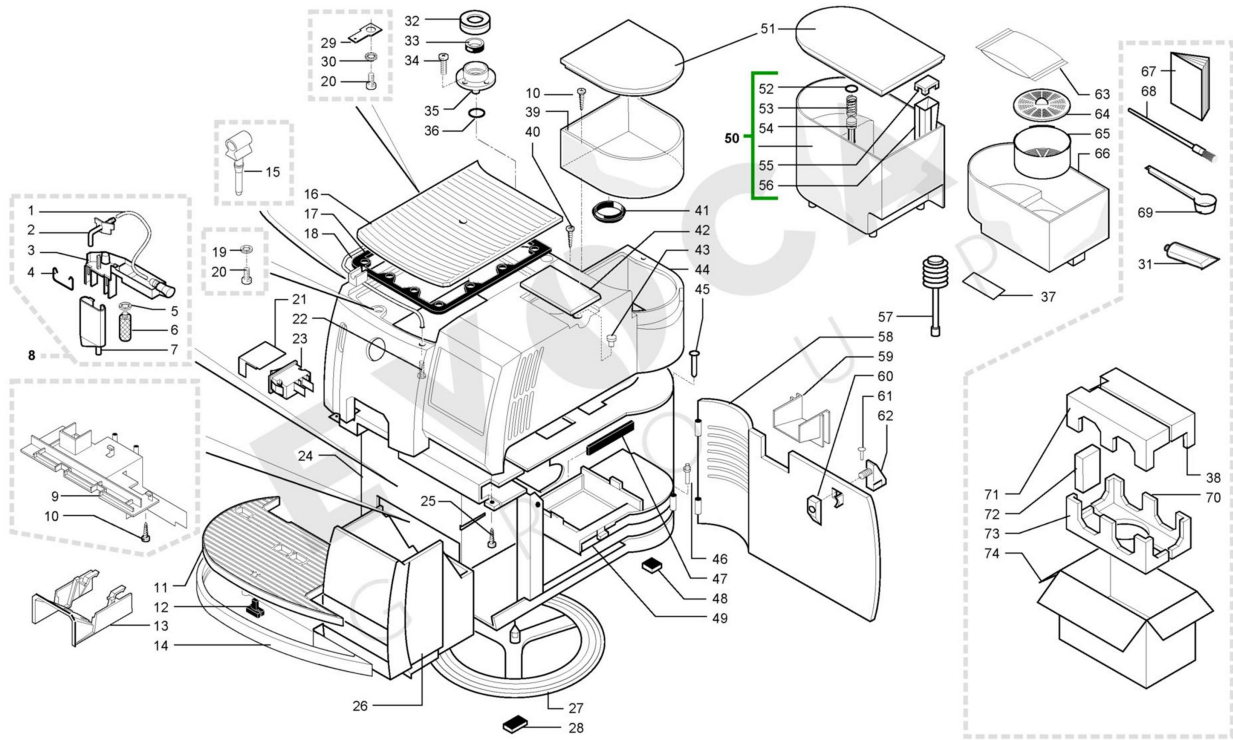









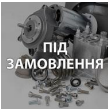

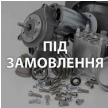









TAVOLA NR. 1 - ARTICOLO SAECO ROYAL COFFEE BAR

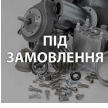

Model Machine

MACSAE018

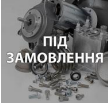























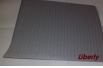

SAECO ROYAL COFFEE BAR

| Web | Pos. | Foto | Item - Replace by | Description |
|--|------|---|-------------------|--|
|  | | | | <i>Press - CTRL + CLICK go to item in a new window Натисніть - Ctrl + права кнопка миші щоб відкрити запчастину в новому вікні</i> |
|  | 1 |  | 9972.027 | SILICONE TUBE 5X8 L. 85MM <i>SILICONE TUBE BROWN 5X8 L. 85 MM</i> |
|  | 2 |  | 11003705 | CONNECTOR 90° DISPENSER BROWN <i>CONNECTOR 90° DISPENSER BROWN</i> |
|  | 3 |  | 0327.010.050 | FIXED CASING DISPENSER BLACK <i>FIXED CASING DISPENSER BLACK</i> |
|  | 3 |  | 0327.010.760 | FIXED CASING DISPENSER BLUE <i>CORPO FISSO EROGATORE BLUE</i> |
|  | 4 |  | 0327.037 | SPRING FOR DISPENSER <i>SPRING FOR DISPENSER</i> |
|  | 5 |  | 0301.052 | SEAL FOR DISPENSER SCREW <i>SEAL FOR DISPENSER SCREW</i> |
|  | 6 |  | 0301.050 | SCREW M3 FOR DISPENSER <i>VITE M3 X EROGATORE</i> |
|  | 7 |  | 0327.011.050 | MOBILE DISPENSER CASING BLACK <i>MOBILE DISPENSER CASING BLACK</i> |
|  | 7 |  | 0327.011.760 | MOBILE DISPENSER CASING BLUE <i>CORPO MOBILE EROGATORE BLUE</i> |
|  | 8 |  | 0327.A07.050 | DISPENSER ASS. BLACK <i>ASS.EROGATORE NERO</i> |
|  | 8 |  | 0327.A07.760 | DISPENSER ASS. BLUE <i>ASS.EROGATORE BLUE</i> |
|  | 9 |  | 0301.033.150 | TANK CASING GREY <i>TANK CASING GREY</i> |

Model Machine

MACSAE018

SAECO ROYAL COFFEE BAR

| | | | | |
|--|----|---|--------------|--|
|  | 10 |  | 129670202 | TCB PANELVIT SCREW 3,5X16 TESTA D=8 ZNP TCB PANELVIT SCREW 3,5X16 TESTA D=8 ZNP |
|  | 11 |  | 0314.016.770 | GRATE FOR TANK PAINTED SILVER GRATE FOR TANK PAINTED SILVER |
|  | 12 |  | 145500211 | RED FLOAT FOR DRIP TRAY SEB GRANCAF. GALLEGGIANTE ROSSO X SEB GRANCAFFE' |
|  | 13 |  | 0312.009.710 | DISPENSER LID GREY DISPENSER LID GREY |
|  | 13 |  | 0312.009.760 | DISPENSER LID PAINTED BLUE DISPENSER LID PAINTED BLUE |
|  | 14 |  | 0314.022.710 | GREY DRIP TRAY VASCA RACCOGLIGOCCE GRIGIO |
|  | 14 |  | 0314.022.760 | BLUE DRIP TRAY VASCA RACCOGLIGOCCE VERN.BLU |
|  | 15 |  | 0312.016.280 | RUBBER TUBE HOLDER GREY RUBBER TUBE HOLDER GREY |
|  | 16 |  | 0312.015.66A | 230V-CLEAR/GREY CUPWARMING PLATE ASSY. ASS.PIASTRA SCALDATAZZE ARG. 230V |
|  | 16 |  | 0312.015.66F | 120V-CLEAR/GREY CUPWARMING PLATE ASSY. 120V-CLEAR/GREY CUPWARMING PLATE ASSY. |
|  | 17 |  | 0312.014 | CUPWARMER SEAL CUPWARMER SEAL |
|  | 18 |  | 0329.002 | TUBE FOR CASING LID TUBO X COPERCHIO CARCASSA |
|  | 19 |  | U201.005 | PLAIN WASHER 4,3X12 DIN 7349 GAL PLAIN WASHER 4,3X12 DIN 7349 GAL |
|  | 20 |  | 129573202 | SCREW TCB TORX 20 M4X8 AUTOFORMING ZN-B SCREW TAPT M4X8 UNI 8112 |

Model Machine

MACSAE018

























SAECO ROYAL COFFEE BAR

| | | | | |
|--|----|---|--------------|---|
|  | 21 |  | 0327.036 | GENERAL SWITCH PROTECTION <i>GENERAL SWITCH PROTECTION</i> |
|  | 22 |  | U043.012 | SCREW TCB TORX 20 M4X6 ZN-B <i>VITE TCBC M4,0X6 UNI 7687 Z</i> |
|  | 23 |  | NE03.038 | BIPOLAR SWITCH FUSIT C1250AR <i>BIPOLAR SWITCH FUSIT C1250AR</i> |
|  | 24 |  | 0341.002.760 | BLUE CASING WATER SUPPLY <i>ASS.CARCASSA R.I. BLU</i> |
|  | 24 |  | 11009980 | 7021/GREY CASING WATER SUPPLY <i>7021/GREY CASING WATER SUPPLY</i> |
|  | 24 |  | 11025919 | BLUE CASING WATER SUPPLY V2 <i>BLUE CASING WATER SUPPLY V2</i> |
|  | 24 |  | 11025920 | 7021/GREY CASING WATER SUPPLYV2 <i>7021/GREY CASING WATER SUPPLYV2</i> |
|  | 25 |  | U110.005 | SCREW AUT.TCB 3,9X9,5 DIN 7981F <i>VITE AUT.TCB 3,9X9,5 DIN 798</i> |
|  | 26 |  | 0312.032.710 | 7021/GREY DUMP BOX <i>7021/GREY DUMP BOX</i> |
|  | 26 |  | 0312.032.760 | ROYAL/BLUE DUMP BOX <i>CASSETTO FONDI BLUE ROYAL</i> |
|  | 26 |  | 11025950 | ROYAL/BLUE DUMP BOX V2 <i>ROYAL/BLUE DUMP BOX V2</i> |
|  | 26 |  | 11025951 | 7021/GREY DUMP BOX V2 <i>7021/GREY DUMP BOX V2</i> |
|  | 27 |  | 0301.057.150 | GREY ROTATING RING WITH FEET <i>ROTATING RING WITH GREY FEET</i> |
|  | 28 |  | 9991.096 | ADHESIVE FOOT 8X15X3,2 <i>ADHESIVE FOOT 8X15X3,2</i> |

Model Machine

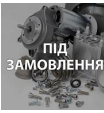
MACSAE018













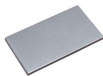

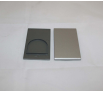











SAECO ROYAL COFFEE BAR

| | | | | |
|--|----|--|--------------|--|
|  | 29 |  | NE15.003 | MALE TONGUE PLAIN 6,3 D.5,2 LINGUETTA MASCHIO PIANA 6,3 D.5,2 |
|  | 30 |  | 128310404 | МЕТАЛЕВЕ УБЧАСТЕ КОЛИЩАТКО UNI 8842 A4 WASHER UNI 8842 A4 BURNISHED |
|  | 31 |  | 11005044 | SAECO KLUBERLUB NH1 11-222 TUBE 5GR. SAECO KLUBER TRIBOSTAR SIL 2 TUBE 5GR. |
|  | 32 |  | 0701.031.150 | GREY WATER VALVE GACO DIM 14 SEAL COVER SEAL COVER GREY |
|  | 33 |  | 145842900 | NBR WATER CONT.VALVE GACO DIM14 SEAL NBR WATER CONT.VALVE GACO DIM14 SEAL |
|  | 34 |  | 129532521 | SCREW TSP2,9X9,5 DIN 7982 SS SCREW TSP2,9X9,5 DIN 7982 SS |
|  | 35 |  | 0701.014.150 | GREY WATER VALVE GACO DIM 14 SEAL CONT. GREY WATER VALVE GACO DIM 14 SEAL CONT. |
|  | 36 |  | 140320461 | OR ORM 0080-20 TERMOIL OR ORM 0080-20 IN TERMOIL |
|  | 37 |  | 0301.961 | STICKER FOR WATER HARDNESS TEST TEST DUREZZA ACQUA |
|  | 38 |  ПІД ЗАМОВЛЕННЯ | 0314.906 | TECHMATE RIGHT UPPER INSERT TECHMATE RIGHT UPPER INSERT |
|  | 39 |  ПІД ЗАМОВЛЕННЯ | 0317.010.230 | COFFEE CONTAINER UL CONTENITORE CAFFE' UL |
|  | 39 |  | 0329.006.230 | КОНТЕЙНЕР (БУНКЕР) ДЛЯ КАВИ КАВОВАРКИ SAECO 996530041763 CONTENITORE CAFFE' |
|  | 40 |  | 12001622 | SCREW TCB TORX B 3,5X9,5 SCHEET NIK SCREW TCB TORX B 3,5X9,5 SCHEET NIK |

Model Machine

MACSAE018

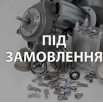















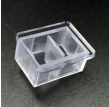









SAECO ROYAL COFFEE BAR

| | | | | |
|--|----|---|--------------|---|
|  | 41 |  | 9161.270 | SEAL FOR COFFEE CONTAINER <i>GUARN.X CONT.CAFFE' NBR/45 K</i> |
|  | 42 |  | 0313.008.770 | SILVER DOSER LID DIGITAL <i>COPERCHIO DOSATORE DIGITAL ARG.</i> |
|  | 42 |  | 0334.011.770 | DOSER LID UL DIGITAL SILVER <i>DOSER LID UL DIGITAL SILVER</i> |
|  | 43 |  | 0312.013.280 | PLUG FOR SCREW HOLE GREY <i>PLUG FOR SCREW HOLE GREY</i> |
|  | 44 |  | 0341.003.770 | LID SAECO COFFEE BAR SILVER <i>COPERCHIO SAECO COFFEE BAR A</i> |
|  | 44 |  | 11009981 | LID SAECO COFFEE BAR SILVER <i>LID SAECO COFFEE BAR SILVER</i> |
|  | 45 |  | 0301.019 | NIK/BRASS PIN FOR DOOR SUPERAUT. <i>NIK/BRASS PIN FOR DOOR SUPERAUT.</i> |
|  | 46 |  | 0301.020 | NIK/BRASS PIN FOR DOOR SUPERAUT. <i>NIK/BRASS PIN FOR DOOR SUPERAUT.</i> |
|  | 47 |  | 9161.140 | SEAL FOR UNIT PLATE <i>GUARNIZIONE X PIASTRA GRUPPO</i> |
|  | 48 |  | 147623150 | BLACK SQUARE ADHESIVE FOOT 5023 <i>BLACK SQUARE ADHESIVE FOOT 5023</i> |
|  | 49 |  | 0301.041.150 | GREY BREW UNIT SUPPORT PLATE ROYAL <i>PIASTRA SUPPORTO GRUPPO GRIGIO</i> |
|  | 50 |  | 0301.046.230 | WATER TANK ASS. <i>ASS.SERBATOIO ACQUA SUPERAUTOMATICA</i> |
|  | 50 |  | 0317.A16.230 | WATER TANK ASS. MAGIC UL <i>WATER TANK ASS. MAGIC UL</i> |
|  | 51 |  | 20006540 | KIT RIC.COP.CAF.ARG+COP.ACQ.ARG.ROYAL <i>KIT RIC.COP.CAF.ARG+COP.ACQ.ARG.ROYAL</i> |

Model Machine

MACSAE018

SAECO ROYAL COFFEE BAR

| | | | | |
|--|----|---|--------------|---|
|  | 52 |  | NM01.032 | ПРОКЛАДКА O-RING ORM 0060-30 ДЛЯ КАВОМАШИНИ ЧЕРВОНА SAECO... OR ORM 0060-30 SILICONE ROSSA |
|  | 53 |  | 9161.110 | PISTON SPRING FOR SUPERAUT. MOLLA X PISTONCINO SUPERAUTO |
|  | 54 |  | 147660562 | GREY PISTON FOR WATER CONTAINER VALVE GREY PISTON FOR WATER CONTAINER VALVE |
|  | 55 |  | 9161.050.230 | NAT/TRANSF.FLOATING SPACE PLUGMAGIC TAPPO X GALLEGGIANTE SUPERAUTOM. |
|  | 56 |  | 9161.112.150 | GREY LEVEL FLOAT GALLEGGIANTE DI LIVELLO GRIGIO |
|  | 57 |  | 147700200 | LOADING PUMP DIAMETER 17 MM LOADING PUMP DIAMETER 17 MM |
|  | 58 |  | 0313.001.710 | DOOR ASS. ROYAL GREY RAL 7021 DOOR ASS. ROYAL GREY RAL 7021 |
|  | 58 |  | 0313.001.760 | DOOR ASS. ROYLA BLUE DOOR ASS. ROYLA BLUE |
|  | 59 |  | 0313.012.710 | 7021/GREY DOOR COVER S/SCR.ROYAL 7021/GREY DOOR COVER S/SCR.ROYAL |
|  | 59 |  | 0313.012.760 | BLUE DOOR COVER S/SCR.ROYAL BLUE DOOR COVER S/SCR.ROYAL |
|  | 60 |  | 0301.040.150 | GREY DOOR CLOSURE LEVER GREY DOOR CLOSURE LEVER |
|  | 61 |  | U433.001 | NAIL 2X6 UNI 7591 BURN. NAIL 2X06 UNI 7591 BURN. |
|  | 62 |  | 0301.039.710 | 7021/GREY DOOR CLOSURE KNOB DOOR CLOSURE KNOB GREY |
|  | 62 |  | 0301.039.760 | BLUE DOOR CLOSURE KNOB BLUE DOOR CLOSURE KNOB |

Model Machine

MACSAE018

SAECO ROYAL COFFEE BAR

| | | | | |
|--|----|---|-----------|---|
|  | 63 |  | 0313.013 | RESIN PACKET INTAFIL SYSTEM <i>SACCHETTO RESINA SISTEMA INT</i> |
|  | 64 |  | 0313.015 | RESIN CONTAINER LID INTAFIL <i>RESIN CONTAINER LID INTAFIL</i> |
|  | 65 |  | 0313.014 | RESIN CONTAINER INTAFIL SYSTEM <i>RESIN CONTAINER INTAFIL SYSTEM</i> |
|  | 66 |  | 0313.016 | WATER TANK ADAPTER INTAFIL <i>WATER TANK ADAPTER INTAFIL</i> |
|  | 67 |  | 0341.951 | INSTRUCTION BOOKLET I D F GB UL <i>INSTRUCTION BOOKLET I D F GB UL</i> |
|  | 67 |  | 0341.952 | INSTRUCTION BOOKLET GB E P NL <i>INSTRUCTION BOOKLET GB E P NL</i> |
|  | 69 |  | 146680659 | GREY MEASURE WITH HOLE <i>GREY MEASURE WITH HOLE</i> |
|  | 70 |  | 0314.905 | TECHMATE RIGHT LOWER INSERT <i>TECHMATE RIGHT LOWER INSERT</i> |
|  | 71 |  | 0314.907 | TECHMATE LEFT UPPER INSERT <i>TECHMATE LEFT UPPER INSERT</i> |
|  | 72 |  | 0314.909 | DRIP TRAY BOX <i>DRIP TRAY BOX</i> |
|  | 73 |  | 0314.904 | TECHMATE LEFT LOWER INSERT <i>TECHMATE LEFT LOWER INSERT</i> |
|  | 74 |  | 0313.904 | EXTERNAL BOX FLEXO ROYAL <i>EXTERNAL BOX FLEXO ROYAL</i> |

Model Machine

MACSAE018

SAECO ROYAL COFFEE BAR

MACSAE018.T.0002



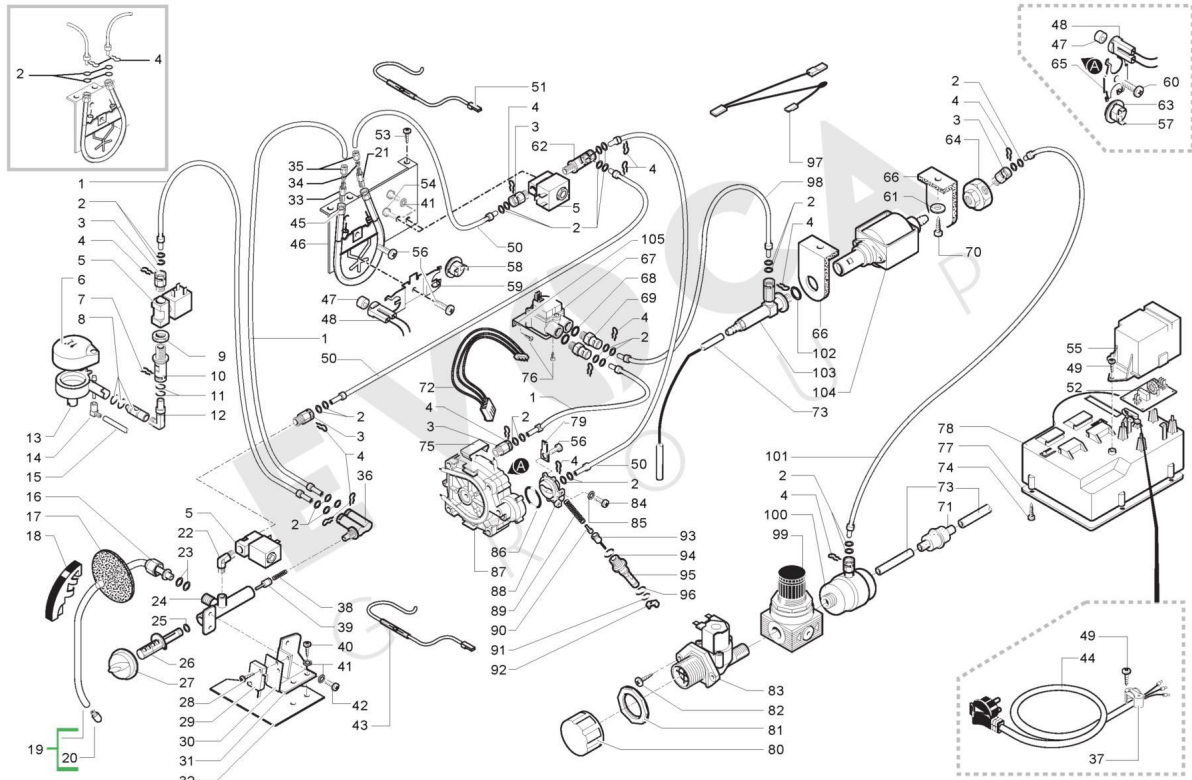























TAVOLA NR. 2 - ARTICOLO SAECO ROYAL COFFEE BAR



Model Machine

MACSAE018





























SAECO ROYAL COFFEE BAR

| Web | Pos. | Foto | Item - Replace by | Description |
|--|------|---|-------------------|--|
|  | | | | <i>Press - CTRL + CLICK go to item in a new window Натисніть - Ctrl + права кнопка миші щоб відкрити запчастину в новому вікні</i> |
|  | 1 |  | 9979.A38 | TEFLON TUBE ASS. 4X2 L.150 7-7 ASS.TUBO TEFLON 4X2 L.150 7-7 |
|  | 1 |  | 9979.A50 | TEFLON TUBE ASS. 4X2 L.150 7 ASS.TUBO TEFLON 4X2 L=150 7 |
|  | 2 |  | NM02.028 | OR 2015 EPDM FDA OR 2015 EPDM FDA |
|  | 3 |  | 11008875 | TEA/BRASS CONNECTOR 1/8" FOR TUBE D=4 TEA/BRASS CONNECTOR 1/8 FOR TUBE D=4 |
|  | 4 |  | 9011.144 | SS FORK FOR TUBE D=4 FORCELLA X TUBO D.4 |
|  | 5 |  | 11008828 | ELETTROV.OLAB 2VIE 1/8" FEM.OTT/TEA 230V ELETTROV.OLAB 2VIE 1/8 FEM.OTT/TEA 230V COD OLAB 6000-4 |
|  | 5 |  | 11008829 | ELETTROV.OLAB 2VIE 1/8" FEM.OTT/TEA 120V ELETTROV.OLAB 2VIE 1/8" FEM.OTT/TEA 120V |
|  | 60,1 |  | 0314.018.710 | COVER FOR CAPPUCINA. PAINTED GREY COVER FOR CAPPUCINA. PAINTED GREY |
|  | 6 |  | 0314.018.760 | COVER FOR CAPPUCINATORE BLUE COPERTURA X CAPPUCINATORE B |
|  | 7 |  | 9161.135 | SPRING FOR STEAM FAUCET MOLLA X RUBINETTO VAPORE |
|  | 8 |  | 142270200 | TUBE+W/O RETAIN.CAPPUCINATORE+/2OR CANOTTO S/FERMO X CAPPUCINA OR 142270600, SAE307 , 140324461 |
|  | 9 |  | U303.002 | NUT HEXAGONAL M12X1,25UNI 5589 NUT HEXAGONAL M12X1,25UNI 5589 |
|  | 10 |  | 11008452 | TEA/BRASS SUPPORT FOR 90°CONNECTOR TEA/BRASS SUPPORT FOR 90°CONNECTOR |

Model Machine

MACSAE018























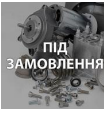

SAECO ROYAL COFFEE BAR

| | | | | |
|--|----|---|--------------|--|
|  | 11 |  | NM02.007 | OR 2025 IN TERMOIL OR 2025 TERMOIL |
|  | 12 |  | 11008451 | ПАТРУБОК ДЛЯ ВЗБИВАННЯ SAECO ROYAL 996530004872 TEA/BRASS 90°CONNECT.FOR CAPPUCCINATORE |
|  | 13 |  | 142520130 | CAPPUCCINATORE AS.NEUTRAL WHITE AS.CAPPUCCINATORE NEUTRO BIANCO |
|  | 13 |  | 142520150 | CAPPUCCINATORE AS.NEUTRAL BLACK AS.CAPPUCCINATORE NEUTRO NER |
|  | 14 |  | 9991.122.010 | CONN. FOR CAPPUCCINATORE WHITE RACCORDO X CAPPUCCINATORE BI |
|  | 14 |  | 9991.122.050 | CONN. FOR CAPPUCCINATORE BLACK RACCORDO X CAPPUCCINATORE NERO |
|  | 15 |  | 9972.045 | SILICONE TUBE 3,5X6 L=350 MM DS TUBO SILICONE 3,5X6 L.350 MM |
|  | 16 |  | 9161.438 | NUT FOR STEAM TUBE NUT FOR STEAM TUBE |
|  | 17 |  | 9161.058.150 | INTERNAL PROTECTION FOR TUBE GREY INTERNAL PROTECTION FOR TUBE GREY |
|  | 18 |  | 9161.055.710 | 7021/GREY STEAM TUBE HANDGRIP 7021/GREY STEAM TUBE HANDGRIP |
|  | 18 |  | 9161.055.760 | BLUE STEAM TUBE HANDGRIP IMPUGNATURA X TUBO VAPORE BLUE |
|  | 19 |  | 11004226 | STAINLESS STEEL STEAM TUBE ROYAL ASSY. STAINLESS STEEL STEAM TUBE ROYAL ASSY. |
|  | 20 |  | 9011.190 | DISPENSER FOR STEAM TUBE D.1,5 EROGATORE X TUBO VAPORE D.1,5 |
|  | 21 |  | 227961803 | NIK/BRASS INLET CONNECTOR BOILER NIK/BRASS INLET CONNECTOR BOILER |

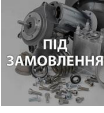
Model Machine

MACSAE018

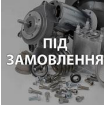

























SAECO ROYAL COFFEE BAR

| | | | | |
|--|----|---|---------------------|---|
|  | 22 |  | NR07.029 | STANDARD CONN. L MM 1/8 NICK <i>RACCORDO STANDARD A L MM 1/8 NIK</i> |
|  | 23 |  | 140324461 | OR ORM 0060-20 TERMOIL <i>OR ORM 0060-20 IN TERMOIL</i> |
|  | 24 |  | 11009006 | МЕТАЛЕВИЙ КОРПУС КРАНА PHILIPS SAECO 996530005168 <i>TEA/BRASS FAUCET BODY</i> |
|  | 25 |  | 140321461 | O-RING 2018 EPDM <i>OR 2018 IN EPDM</i> |
|  | 26 |  | 9161.057 | ШТОК КРАНА ПОДАЧІ ВОДИ/ПАРУ ДЛЯ КАВОВАРКИ SAECO <i>ASTA RUBINETTO VAPORE</i> |
|  | 27 |  | 0312.004.760 | STEAM KNOB PAINTED BLUE <i>POMELLO VAPORE VERN.BLUE</i> |
|  | 27 |  ПІД ЗАМОВЛЕННЯ | 0347.010.710 | STEAM KNOB GREY RAL 7021 <i>STEAM KNOB GREY RAL 7021</i> |
|  | 28 |  | U109.014 | SCREW AUT.TCB 2,9X16 DIN 7981C <i>VITE AUT.TCB 2,9X16 DIN 7981 C NIK</i> |
|  | 29 |  | NE05.013 | МИКРОПЕРЕКЛЮЧАТЕЛЬ SAIA XGK52-81-J23 PHILIPS SAECO <i>MICROINTERRUTTORE</i> |
|  | 30 |  ПІД ЗАМОВЛЕННЯ | 11009072 | INSULATE PROTECTION 24X38,8 FOR MICRO <i>INSULATE PROTECTION 24X38,8 FOR MICRO</i> |
|  | 31 |  | 0312.011 | STEEL STEAM FAUCET BRACKET ROYAL <i>STEEL STEAM FAUCET BRACKET ROYAL</i> |
|  | 32 |  ПІД ЗАМОВЛЕННЯ | 0348.013 | CLOSURE PLATE <i>CLOSURE PLATE</i> |
|  | 33 |  | 227961903 | NIK/BRASS CONNECTOR FOR TUBE TEFLON 4X2 <i>NIK/BRASS CONNECTOR FOR TUBE TEFLON 4X2</i> |

Model Machine

MACSAE018

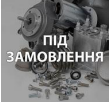









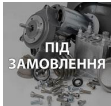



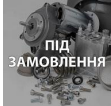

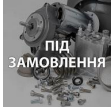





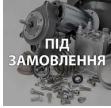

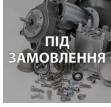

SAECO ROYAL COFFEE BAR

| | | | | |
|--|----|---|-----------|--|
|  | 34 |  | 9161.431 | OGIVE BUSH D=4 OGIVE BUSH D=4 |
|  | 35 |  | 123460220 | BRASS NUT M8X1FOR TEFLON TUBED=4 DADO M8X1 X TUBO TEFLON D=4 IN OTTONE |
|  | 36 |  | 11008822 | TEA/BRASS 90° CONNECTOR DOUBLEFAST LOCK TEA/BRASS 90° CONNECTOR DOUBLE FAST LOCK |
|  | 37 |  | 9991.039 | CABLE RETAINER UL CABLE RETAINER UL |
|  | 38 |  | 9011.007 | SPRING FOR PIN SPRING FOR PIN |
|  | 39 |  | 11009018 | TEA/BRASS PISTON L=15,1 ASSY. TEA/BRASS PISTON L=15,1 ASSY. NUOVO PREZZO 2,42 SAECO |
|  | 40 |  | 12001622 | SCREW TCB TORX B 3,5X9,5 SCHEET NIK SCREW TCB TORX B 3,5X9,5 SCHEET NIK |
|  | 41 |  | 128310404 | METALEBE UBCHASTE KOLISHCHATKO UNI 8842 A4 WASHER UNI 8842 A4 BURNISHED |
|  | 42 |  | 129823802 | TCB SCREW M4X8 UNI 7687 ZNP VITE TCB M4X8 UNI 7687 ZNP |
|  | 43 |  | 0314.810 | CABLE 1 WIRE SILIC.WHITE TH/FUSE 192° CABLAGGIO BIANCO CON TERMOFU |
|  | 43 |  | 0317.821 | CABLE 1WIRE SILIC.BLUE AWG18 TH/FUSE192° CABLE 1WIRE SILIC.BLUE AWG18 TH/FUSE192° |
|  | 44 |  | NE01.114 | POWER CABLE AUSTRALIA POWER CABLE AUSTRALIA |
|  | 44 |  | NE01.116 | CABLE USA 3P BLACK 1 MM CABLE USA 3P BLACK 1 MM |
|  | 44 |  | NE01.118 | BLACK POWER CABLE CH L=1500MM BLACK POWER CABLE CH L=1500MM |

Model Machine

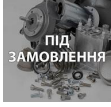
MACSAE018

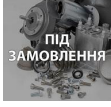











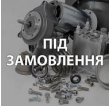



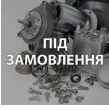





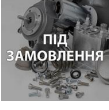

SAECO ROYAL COFFEE BAR

| | | | | |
|--|----|---|---------------------|---|
|  | 44 |  | NE01.120 | BLACK POWER CABLE SCHUKO L=1500 <i>BLACK POWER CABLE SCHUKO L=1500</i> |
|  | 45 |  | 0334.R10.00A | KIT SPARES BLECKMANN BOILER 230V <i>KIT RICAMBIO CALDAIA BLECKMANN 230V</i> |
|  | 45 |  | 0334.R10.00F | KIT SPARES BLECKMANN BOILER 120V <i>KIT SPARES BLECKMANN BOILER 120V</i> |
|  | 46 |  | 0334.001 | NEW SYSTEM BRACKET <i>NEW SYSTEM BRACKET</i> |
|  | 47 |  | 11004424 | ALUM.SPACER FOR PHILIPS SENSORM5000 <i>ALUM.SPACER FOR PHILIPS SENSOR M5000</i> |
|  | 48 |  | 9019.A65 | SENSOR FOR AUTOMATICS ASSY. <i>SENSOR FOR AUTOMATICS ASSY.</i> |
|  | 48 |  | 9019.A66 | SENSOR FOR AUTOMATICA UL ASSY. <i>ASS.SENSORE X AUTOMATICA UL 120V</i> |
|  | 49 |  | U140.009 | PANELVIT TCB 3,0X16 DIN 7505 BGAL <i>PANELVIT TCB 3,0X16 DIN 7505 B GAL</i> |
|  | 50 |  | 9979.A55 | TEFLON TUBE ASS. 4X2 L.260 7-7 <i>ASS.TUBO TEFLON 4X2 L.260 7-</i> |
|  | 50 |  | 9979.A88 | TEFLON TUBE ASS. 4X2 L.280 7 <i>ASS.TUBO TEFLON 4X2 L.280 7</i> |
|  | 51 |  | 0334.822 | CABLE 1 WIRE SILIC.WHITE TH/FUSE 216° <i>CABLAGGIO BIANCO C/TERMOFUS.</i> |
|  | 51 |  | 0334.823 | CABLE 1WIRE SIL.WHITE AWG16 TH/FUSE 216° <i>CABLE 1WIRE SIL.WHITE AWG16 TH/FUSE 216°</i> |
|  | 52 |  | 0301.828.00F | FILTRATION CARD SUPERAUTOM. 120V <i>SCHEDA FILTRAGGIO SUPERAUTOM</i> |
|  | 52 |  | 0314.804 | FILTRATION CARD 12A <i>FILTRATION CARD 12A</i> |

Model Machine

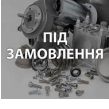
MACSAE018











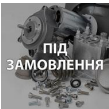









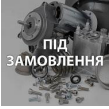





SAECO ROYAL COFFEE BAR

| | | | | |
|--|----|---|--------------|--|
|  | 53 |  | U110.004 | SCREW AUT.TCB 3,5X6,5 DIN 7981F VITE AUT.TCB 3,5X6,5 DIN 7981 F NIK |
|  | 54 |  | U043.012 | SCREW TCB TORX 20 M4X6 ZN-B VITE TCBC M4,0X6 UNI 7687 Z |
|  | 55 |  | 9161.126.150 | COVER FOR FILTER CARD GREY COVER FOR FILTER CARD GREY |
|  | 55 |  | 9161.336.150 | COVER FOR FILTER CARD GREY UL COVER FOR FILTER CARD GREY UL |
|  | 56 |  | U046.003 | SCREW TCBD TORX 20 M4X12 ZN-B VITE TCBC M4,0X12 ROND.DENT. |
|  | 57 |  | NE09.021 | THERMOSTAT 150°NC FASTON 90° THERMOSTATO 150°NC FASTON 90° |
|  | 58 |  | NE09.006 | THERMOSTAT 170°NC FAST. 90°+WASHER THERMOST.170°NC FASTON 90°C/R |
|  | 59 |  | 9011.187 | THERMOSTAT RETAINING SPRING THERMOSTAT RETAINING SPRING |
|  | 60 |  | U023.022 | SCREW TCEI M6,0X30 UNI 5931 8.8 ZNP SCREW TCEI M6,0X30 UNI 5931 8.8 ZNP |
|  | 61 |  | U207.004 | PLAIN WASHER 4,3X16 UNI 6592 GAL PLAIN WASHER 4,3X16 UNI 6592 GAL |
|  | 62 |  | 227901103 | NIK/BRASS 90°CONNECTOR DOUBLEFAST LOCK NIK/BRASS 90°CONNECTOR DOUBLEFAST LOCK |
|  | 63 |  | 9991.085 | THERMOSTAT FIXING WASHER RONDELLA FERMATERMOSTATI |
|  | 64 |  | 9079.A14 | REAR CONNECTOR ASS.1/8 FOR ULKA PU REAR CONNECTOR ASS.1/8 FOR ULKA PU |

Model Machine

MACSAE018

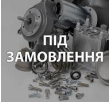











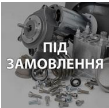













SAECO ROYAL COFFEE BAR

| | | | | |
|--|----|---|--------------|---|
|  | 65 |  | 9011.034 | THERMOSTAT RETAINING SPRING <i>THERMOSTAT RETAINING SPRING</i> |
|  | 66 |  | 149185850 | ТРИМАЧ (ГУМОВИЙ)ПОМПИ ДЛЯ КАВОМАШИН SAECO MAGIC 4002012 (...) <i>SUPPORTO POMPA EATON MAGIC 4</i> |
|  | 67 |  | NV99.029 | DIGMESA TURBINE IN BRASS <i>TURBINA DIGMESA IN OTTONE</i> |
|  | 68 |  | NM01.049 | OR ORM 0070-20 SILICONE <i>OR ORM 0070-20 SILICONE</i> |
|  | 69 |  | 9161.308 | BRASS CONNECTOR WATER SYSTEM TURBINE <i>RACCORDO X TURBINA R.I.</i> |
|  | 70 |  | U110.003 | SCREW AUT.TCB 3,5X9,5 DIN 7981F <i>VITE AUT.TCB 3,5X9,5 DIN 798</i> |
|  | 71 |  | 144650300 | ФІЛЬТР ОЧИСТКИ ВОДИ ДЛЯ КАВОМАШИНИ SAECO NEW (NV99.001) (88...) <i>ASPIRATION FILTER GAUZE NET 500 (NEW)</i> |
|  | 72 |  | 0341.806 | CONN. ASS. FOR DIGMESA TURBINEUL <i>CONN. ASS. FOR DIGMESA TURBINE UL</i> |
|  | 72 |  | 0701.871 | CONN. ASS. FOR DIGMESA TURBINE <i>CONN. ASS. FOR DIGMESA TURBINE</i> |
|  | 73 |  | 9972.022 | ***SILICONE TUBR 5X10 L.2MT <i>TUBO SILICONE 5X8 L.2 METRI</i> |
|  | 74 |  | 129670202 | TCB PANELVIT SCREW 3,5X16 TESTA D=8 ZNP <i>TCB PANELVIT SCREW 3,5X16 TESTA D=8 ZNP</i> |
|  | 75 |  | 9011.054 | SPRING FOR THERMAL FUSE <i>MOLLA X TERMOFUSIBILE</i> |
|  | 76 |  | U109.011 | SCREW AUT.TCB 3,9X9,5 DIN 7981C <i>SCREW AUT.TCB 3,9X9,5 DIN 7981 C</i> |
|  | 77 |  | 0301.055.150 | LID FOR POWER CABLE CONT. GREY <i>LID FOR POWER CABLE CONT. GREY</i> |

Model Machine

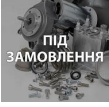
MACSAE018























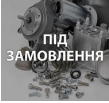

SAECO ROYAL COFFEE BAR

| | | | | |
|--|----|---|---------------------|---|
|  | 78 |  | 0301.056.150 | POWER CABLE CONT. VDE GREY <i>POWER CABLE CONT. VDE GREY</i> |
|  | 78 |  | 0335.008.150 | POWER SUPPLY CABLE GREY UL <i>POWER SUPPLY CABLE GREY UL</i> |
|  | 79 |  | NE15.026 | MALE TONGUE 45° 6,3 D.5,2 <i>LINGUETTA MASCHIO A 45° 6,3 D.5,2</i> |
|  | 80 |  | NV03.002 | CAP 3/4 "KAPSTO 800R 3/4" <i>"CAP 3/4 "KAPSTO 800R 3/4""</i> |
|  | 81 |  | NV99.075 | GHIERA IN NYLON G3/4" 6 MM. <i>"GHIERA IN NYLON G3/4" 6 MM.</i> |
|  | 82 |  | U109.023 | SCREW AUT.TCB 4,2X9,5 DIN 7981C <i>SCREW AUT.TCB 4,2X9,5 DIN 7981 C</i> |
|  | 83 |  | 9121.058.00A | ELECTROVALVE 3/4-1/4 200/240V <i>ELETTROVALVOLA RPE 3/4-1/4 200/240V</i> |
|  | 83 |  | 9121.058.00F | ELECTROVALVE 3/4-1/4 100/120V <i>ELECTROVALVE 3/4-1/4 100/120V</i> |
|  | 84 |  | U043.021 | SCREW TCBC M5,0X8 UNI 7687 GALV. <i>VITE TCBC M5,0X8 UNI 7687 ZNP</i> |
|  | 85 |  | U208.003 | TOOTHED WASHER 5,1X9 BRU <i>TOOTHED WASHER 5,1X9 BRU</i> |
|  | 86 |  | 140324562 | O-RING 2106 SILICONE <i>OR 2106 IN SILICONE</i> |
|  | 87 |  | 421941309101 | KIT SPARES BOILER CASINGS RYLPROF.230V <i>KIT SPARES BOILER CASINGS RYLPROF.230V</i> |
|  | 87 |  | 421941309111 | KIT SPARES BOILER CASINGS RYLPROF.120V <i>KIT SPARES BOILER CASINGS RYLPROF.120V</i> |
|  | 88 |  | 9011.165 | BRASS BOILER SUPPORT WITH TUBECONN.D.4 <i>SUPP. CALDAIA CON ATTACCO TUBO D.4</i> |

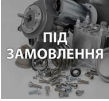
Model Machine

MACSAE018

SAECO ROYAL COFFEE BAR

| | | | | |
|--|-------|---|-----------|---|
|  | 89 |  | 9011.132 | SS SPRING FOR PIN <i>MOLLA X SPILLO</i> |
|  | 90 |  | 11009013 | TEA/BRASS PIN FOR PISTON L=10 <i>TEA/BRASS PIN FOR PISTON L=10</i> |
|  | 91 |  | NM01.057 | OR ORM 0050-20 IN SILICONE <i>OR ORM 0050-20 IN SILICONE</i> |
|  | 92 |  | 11005099 | NATURAL CURSOR V2 FOR BOILER P119 <i>NATURAL CURSOR V2 FOR BOILER P119</i> |
|  | 93 |  | 11009019 | TEA/BRASS PISTON L=20,9 ASSY. <i>TEA/BRASS PISTON L=20,9 ASSY.</i> |
|  | 94 |  | 140320459 | OR ORM 0080-20 SILICONE PTFE/FDA <i>OR ORM 0080-20 IN SILICONE PTFE/FDA</i> |
|  | 95 |  | 9011.100 | PEG FOR VALVE IN PLASTIC <i>PEG FOR VALVE IN PLASTIC</i> |
|  | 96 |  | NM01.035 | OR ORM 0090-20 SILICONE <i>OR ORM 0090-20 SILICONE</i> |
|  | 97 |  | 0341.801 | CONNECTOR ASS. 5POLE <i>CONNECTOR ASS. 5POLE</i> |
|  | 97 |  | 0341.808 | CONN.ASS. 5POLE UL <i>CONN.ASS. 5POLE UL</i> |
|  | 98 |  | 9979.A62 | TEFLON TUBE ASS. 4X2 L.180 7-7 <i>ASS.TUBO TEFLON 4X2 L.180 7-</i> |
|  | 99 |  | NV99.007 | ЦЕНТРАЛЬНИЙ КЛАПАН ВОДИ 1BAR 1/4 MRABIT 52 PHILIPS SAECO 9965... <i>PRESS. REDUCER .1BAR 1/4 MRABIT 52</i> |
|  | 10001 |  | 9160.050 | ASPIRAT.VALVE+PRESS.REDUCER 0,5 BAR ASSY <i>ASPIRAT.VALVE+PRESS.REDUCER 0,5 BAR ASSY</i> |

Model Machine

MACSAE018

SAECO ROYAL COFFEE BAR



1010



9979.A39

TEFLON TUBE ASS. 4X2 L.200 7-7
ASS.TUBO TEFLON 4X2 L.200 7-



1020



140321961

ПРОКЛАДКА O-RING ДЛЯ КАВОМАШИНИ SAECO 2031 TERMOIL
OR 2031 IN TERMOIL



1030



9079.A27

SAFETY VALVE ASS.FAST/LOCK UNIVERS
ASS.VALV.SIC.FAST/LOCK UNIVE



1040

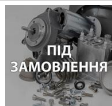

12000130

ULKA PUMP EP5/S GW 100V-50/60HZ
ULKA PUMP EP5/S GW 100V-50/60HZ



1040



12000131

ULKA PUMP EP5/S 120V-60HZ
ULKA PUMP EP5/S 120V-60HZ



1040

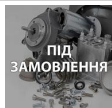

12000140

PUMP 230V-50HZ
ULKA PUMP EP5/S GW 230V-50HZ



1040

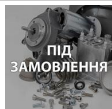

12000182

ULKA PUMP EP5/S GW 220V-60HZ
ULKA PUMP EP5/S GW 220V-60HZ



1050



1509.001

TURBINE BRACKET WATER NETWORK
TURBINE BRACKET WATER NETWORK

Model Machine

MACSAE018

SAECO ROYAL COFFEE BAR

MACSAE018.T.0003



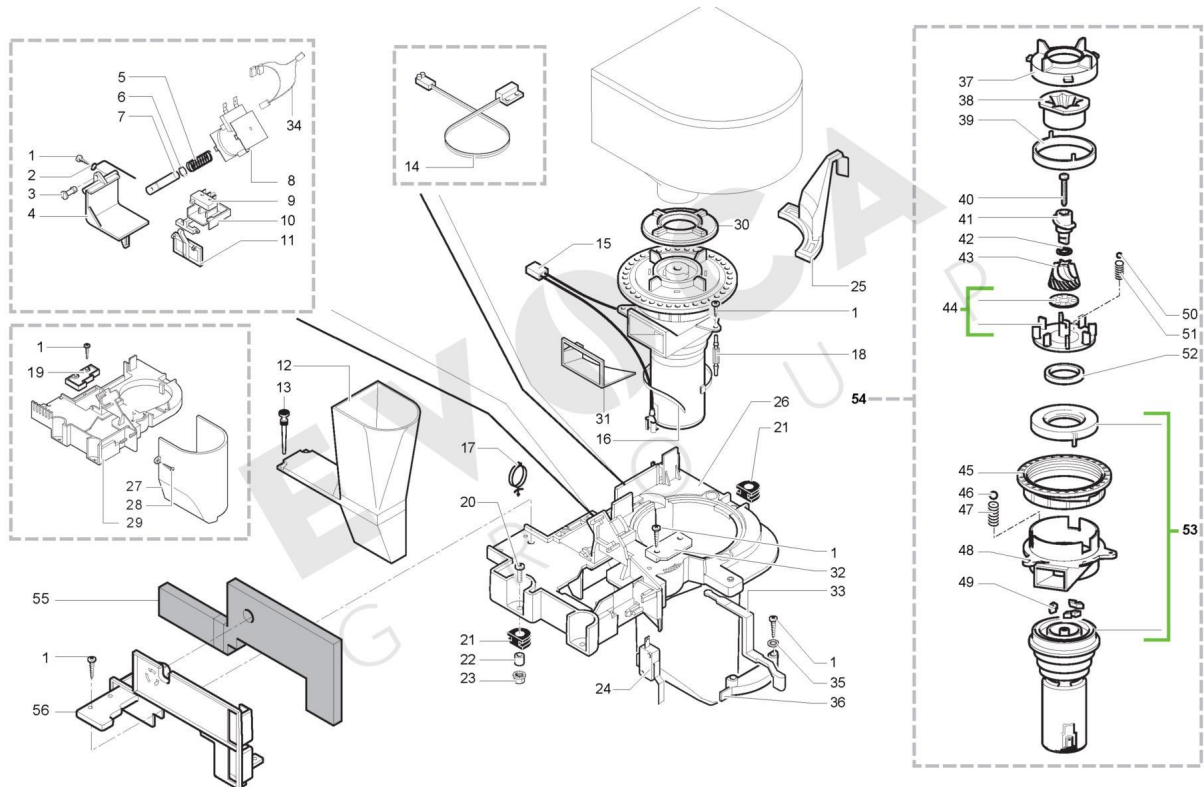























TAVOLA NR. 3 - ARTICOLO SAECO ROYAL COFFEE BAR



Model Machine

MACSAE018













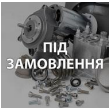













SAECO ROYAL COFFEE BAR

| Web | Pos. | Foto | Item - Replace by | Description |
|--|------|---|-------------------|--|
|  | | | | <i>Press - CTRL + CLICK go to item in a new window Натисніть - Ctrl + права кнопка миші щоб відкрити запчастину в новому вікні</i> |
|  | 1 |  | 129913902 | SCREW TCB TORX 10 3X12 PLAST.ZN-B SCREW TCB TORX 10 3X12 PLAST.ZN-B |
|  | 2 |  | 9161.048 | STEEL GROUND COF.DOSER SCRAPERROD ASTA RASATORE |
|  | 3 |  | 9161.076.150 | GREY GROUND COF.DOSER DOOR PIN PERNO SPORTELLO DOSATORE GRIGIO |
|  | 4 |  | 9161.074.150 | GREY GROUND COFFE DOSER DOOR SPORTELLO DOSATORE GRIGIO |
|  | 5 |  | 126764818 | ПРУЖИНА ЕЛЕКТРОМАГНІТНОГО ДОЗАТОРА ЗЕРНА MAGIC SAECO 916... SPRING ELECTROM.BEAN DOSER MAGIC |
|  | 6 |  | U701.003 | SNAP RING 7 UNI 7434 ANELLO ELASTICO 7 UNI 7434 |
|  | 7 |  | 9161.041 | STEEL GROUND COF.DOSER ELECTROMAGN.CORE NUCLEO ELETTRMAGNETE DOSATORE |
|  | 8 |  | 0301.R30.00A | RICAMBIO BOBINA X SUPERAUTOMAM.230V RICAMBIO BOBINA X SUPERAUTOMAM.230V |
|  | 8 |  | 9129.A07.00F | COFFEE DOSER COIL ASS.120V COFFEE DOSER COIL ASS.120V |
|  | 8 |  | 9129.A07.00H | COFFEE DOSER COIL ASS.240V COFFEE DOSER COIL ASS.240V |
|  | 8 |  | 9129.A21.00A | DOSER COIL FOR SUPERAUTOM.230VASSY. DOSER COIL FOR SUPERAUTOM.230V ASSY. |
|  | 9 |  | NE05.017 | MICROSWITCH MICROSWITCH NE05.017 |
|  | 10 |  | 9161.072.150 | GREY MICRO SUPP.CURSOR GROUNDCOF.DOSER MICRO SUPPORT CURSOR GREY |

Model Machine

MACSAE018























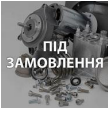

SAECO ROYAL COFFEE BAR

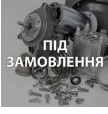
| | | | | |
|--|----|---|---------------------|---|
|  | 11 |  | 9161.073.150 | GREY GROUND COF.DOSE CONTROL COMPENSATOR <i>DOSE CONTROL COMPENSATOR GREY</i> |
|  | 12 |  ПІД ЗАМОВЛЕННЯ | 9161.223.150 | COMPL.HOPP.FOR POWDER COFFEE GRE. <i>COMPL.HOPP.FOR POWDER COFFEE GRE.</i> |
|  | 13 |  | 9161.082 | RUBBER COUPLER <i>AGGANCIO IN GOMMA</i> |
|  | 14 |  | 0301.811 | CONNECTOR 2 POLES LEVEL ASSY. <i>SENSORE ASS.2 POLI LIVELLO</i> |
|  | 14 |  | 0317.829 | CONNECTOR 2 POLES LEVEL UL ASSY. <i>CONNECTOR 2 POLES LEVEL UL ASSY.</i> |
|  | 15 |  | 0301.804 | ПРОВІД 2 ПОЛЮСЛОВИЙ ДЛЯ КАВОМОЛКИ ВЗБОРІ <i>CONNETTORE ASS.2 POLI MACINA</i> |
|  | 15 |  ПІД ЗАМОВЛЕННЯ | 0301.868 | 2P.CONNECTOR COFFEE GRINDER ROYAL UL <i>2P.CONNECTOR COFFEE GRINDER ROYAL UL</i> |
|  | 15 |  | 0301.869 | CONNECTOR ASS. 2 POLE COFFEEGRINDE <i>CONNECTOR ASS. 2 POLE COFFEEGRINDE</i> |
|  | 15 |  ПІД ЗАМОВЛЕННЯ | 0317.818 | CONN. ASS. 2 POLE COFFEEGRINDER UL <i>CONN. ASS. 2 POLE COFFEEGRINDER UL</i> |
|  | 16 |  ПІД ЗАМОВЛЕННЯ | 144320200 | SELF LOCK STRIP W=2.6 L=200 <i>SELF LOCK STRIP W=2.6 L=200</i> |
|  | 17 |  ПІД ЗАМОВЛЕННЯ | NF11.034 | CABLE HOLDER SUPPORT <i>CABLE HOLDER SUPPORT</i> |
|  | 18 |  | 9991.103 | АМОРТИЗАТОР ДЛЯ КОФЕМОЛКИ КОФЕМАШИН PHILIPS SAECO 996530... <i>AMMORTIZZATORE PER MACINACAFE</i> |
|  | 19 |  ПІД ЗАМОВЛЕННЯ | 9161.296.150 | COVER FOR DOSER HOLE <i>COVER FOR DOSER HOLE</i> |
|  | 20 |  | U043.004 | ZN-B TCB TORX 20 M4X16 ZN-B <i>VITE TCBC M4,0X16 UNI 7687 ZNP</i> |

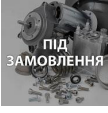
Model Machine

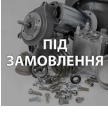
MACSAE018











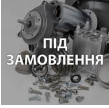







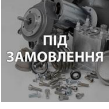



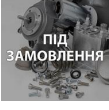

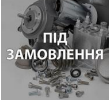

SAECO ROYAL COFFEE BAR

| | | | | |
|--|----|---|--------------|--|
|  | 21 |  | 9991.005 | RUBBER FOR COFFEE GRINDER <i>GOMMINO X MACINA CAFFE</i> |
|  | 22 |  | 9141.003 | SPACER FOR RUBBER <i>SPACER FOR RUBBER</i> |
|  | 23 |  | U324.006 | ШАЙБА M4 <i>NUT M4 FLANGED INDENTED BASE</i> |
|  | 24 |  | NE05.037 | MICROSWITCH <i>MICROINTERRUTTORE</i> |
|  | 25 |  | 9161.080.710 | GREY LEVER GRINDING SETTING <i>GREY LEVER GRINDING SETTING</i> |
|  | 25 |  | 9161.080.760 | GRINDING ADJUSTM.LEVER PAINT.BLUE <i>LEVA REGOLAZIONE MACINATURA VER.BLU</i> |
|  | 26 |  | 9161.365.150 | GREY PLATE COFFEEGRINDER MAGIC/ROYAL <i>PIASTRA X MACINACAFFE' GRIGIO/7016</i> |
|  | 27 |  ПІД ЗАМОВЛЕННЯ | 9161.053.150 | COFFEEGRINDER PROTECTION GREY <i>COFFEEGRINDER PROTECTION GREY</i> |
|  | 27 |  ПІД ЗАМОВЛЕННЯ | 9161.335.150 | COFFEEGRINDER PROTECTION GREYUL <i>COFFEEGRINDER PROTECTION GREY UL</i> |
|  | 28 |  ПІД ЗАМОВЛЕННЯ | U110.003 | SCREW AUT.TCB 3,5X9,5 DIN 7981F <i>VITE AUT.TCB 3,5X9,5 DIN 798</i> |
|  | 29 |  ПІД ЗАМОВЛЕННЯ | 9161.029.150 | PLATE FOR COFFEEGRINDER GREY <i>PLATE FOR COFFEEGRINDER GREY</i> |
|  | 30 |  | 1505.020 | ГУМОВИЙ УЦІЛЬНЮВАЧ КАВОМОЛКИ PHILIPS SAECO 996530046547 <i>GASKET COFFEE GRINDER UL</i> |
|  | 31 |  | 1505.014 | COFFEEGRINDER SEAL <i>GUARNIZIONE DOSATORE</i> |

Model Machine

MACSAE018

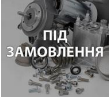

























SAECO ROYAL COFFEE BAR

| | | | | |
|--|----|---|--------------|---|
|  | 32 |  ПІД ЗАМОВЛЕННЯ | 9161.097.150 | GREY GROUND COF.DOSER LEVER FIXING PLATE <i>LEVER FIXING PLATE GREY</i> |
|  | 33 |  | 0313.003.150 | 7016/GREY GROUND COF.DOSER ADJUSTM.LEVER <i>LEVA DI REGOLAZIONE GRIGIO R</i> |
|  | 34 |  | 0301.866 | CONNECTOR ASS. 2 POLE DOSER COIL <i>CONNECTOR ASS. 2 POLE DOSER COIL</i> |
|  | 35 |  | U201.001 | PLAIN WASHER 3,2X9 DIN 7349 GALV. <i>PLAIN WASHER 3,2X9 DIN 7349 GALV.</i> |
|  | 36 |  ПІД ЗАМОВЛЕННЯ | 9161.403.150 | GREY COFFEE DOSE ADJUSTMENT SCALE <i>GREY COFFEE DOSE ADJUSTMENT SCALE</i> |
|  | 37 |  | 149186150 | BLACK UPPER GRINDER SUPPORT MAGIC <i>SUPPORT.NER.X MACINA SUPERIO</i> |
|  | 38 |  ПІД ЗАМОВЛЕННЯ | 9141.039 | UPPER GRINDER <i>UPPER GRINDER</i> |
|  | 39 |  | 142844550 | UPPER GRINDER COVER COFFEE GRIND. MAGIC <i>UPPER GRINDER COVER COFFEE GRIND. MAGIC</i> |
|  | 40 |  ПІД ЗАМОВЛЕННЯ | 129931002 | TORX SCREW T10 TCB 3,5X40 SX ZNG <i>TORX SCREW T10 TCB 3,5X40 SX ZNG</i> |
|  | 41 |  | 147470763 | BLK INCREASE SCREW PIN COF.GRINDER MAGIC <i>PERNO INCREM.A VITE X MACINA</i> |
|  | 42 |  | U201.002 | PLAIN WASHER 10X16X0,2DIN 988GAL <i>ROSETTA PIANA 10X16X0,2DIN</i> |
|  | 43 |  | 9141.040 | CONICAL GRINDER <i>CONICAL GRINDER</i> |
|  | 44 |  ПІД ЗАМОВЛЕННЯ | 149188750 | CONICAL GRIND. SUPP. + RING MAGIC <i>CONICAL GRIND. SUPP. + RING MAGIC</i> |
|  | 45 |  | 146570950 | RING NUT FOR GRINDING ADJUSTMENT MAGIC <i>GHIERA NERA REGOLAZ.MACINATU</i> |

Model Machine

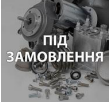
MACSAE018

SAECO ROYAL COFFEE BAR

| | | | | |
|--|----|--|---------------------|---|
|  | 46 |  | 128610421 | STAIL.STELL AISI 304 SPHERE D=3,2MM <i>SFERA D=3,2MM ACCIAIO INOX A</i> |
|  | 47 |  | 126770117 | NEW SPRING SPHERE D=3,2 MOTORMAGIG <i>MOLLA NEW X SFERA D=3,2 MOTORE MAGIC</i> |
|  | 48 |  ПІД ЗАМОВЛЕННЯ | 9141.016 | MOTOR SUPPORT <i>SUPPORTO MOTORE</i> |
|  | 48 |  ПІД ЗАМОВЛЕННЯ | 9141.080 | ТРИМАЧ ДВИГУНА КАВОМОЛКИ ДЛЯ КАВОВАРКИ SAECO 9141.080 <i>SUPPORTO MOTORE</i> |
|  | 49 |  | 140230400 | SHOCK ABS .CONICAL GRINDER SUPP.MAGIC <i>AMMORTIZ.X SUPPOR.MACIN.CONI</i> |
|  | 50 |  | 128610521 | STAIL.STEEL AISI 304 SPHERE D=5,5MM <i>SFERA D=5,5MM ACCIAIO INOX A</i> |
|  | 51 |  | 126765517 | STEEL SPRING SPHERE D=5,5 MOTOR MAGIC <i>MOLLA ACC.X SFERA D=5,5 MOTO</i> |
|  | 52 |  | 140360200 | FELT RING 40X34X5 <i>ANELLO IN FELTRO DE=40 DI=34</i> |
|  | 53 |  ПІД ЗАМОВЛЕННЯ | 0301.R10.00A | SPARE MOTOR UNIT MC 230V <i>GRUPPO RICAMBIO MOTORE MC 230 V</i> |
|  | 54 |  | 9140.005.00A | COFFEE GRINDER STD 230V ASSY. <i>STANDARD 230V COFFEE GRINDER</i> |
|  | 54 |  | 9140.005.00F | COFFEE GRINDER STD 120V ASSY. <i>COFFEE GRINDER STD 120V ASSY.</i> |
|  | 54 |  ПІД ЗАМОВЛЕННЯ | 9140.008.00A | COFFEE GRINDER ITA 230V ASSY. <i>ASS.MACINACAFFE'ITALIA 230V</i> |
|  | 54 |  ПІД ЗАМОВЛЕННЯ | 9140.032.00F | COFFEE GRINDER STD 120V ASSY. <i>COFFEE GRINDER STD 120V ASSY.</i> |
|  | 54 |  ПІД ЗАМОВЛЕННЯ | 9140.035.00A | ASS.MACINACAFFE'ITA 230V <i>ASS.MACINACAFFE'ITA 230V</i> |

Model Machine

MACSAE018

SAECO ROYAL COFFEE BAR



54



9140.036.00A

КАВОМОЛКА В ЗБОРИ 230V PHILIPS SAECO 996530065687
COFFEE GRINDER STD 230V ASSY.



55



9161.382

INSULATOR FOR COFFEE GRINDER
INSULATOR FOR COFFEE GRINDER



56



9161.366.150

GREY/7016 SUPPORT FOR INSULATOR
SUPPORTO X ISOLANTE GRIGIO

Model Machine

MACSAE018

SAECO ROYAL COFFEE BAR

MACSAE018.T.0004

TAVOLA NR. 4 - ARTICOLO SAECO ROYAL COFFEE BAR

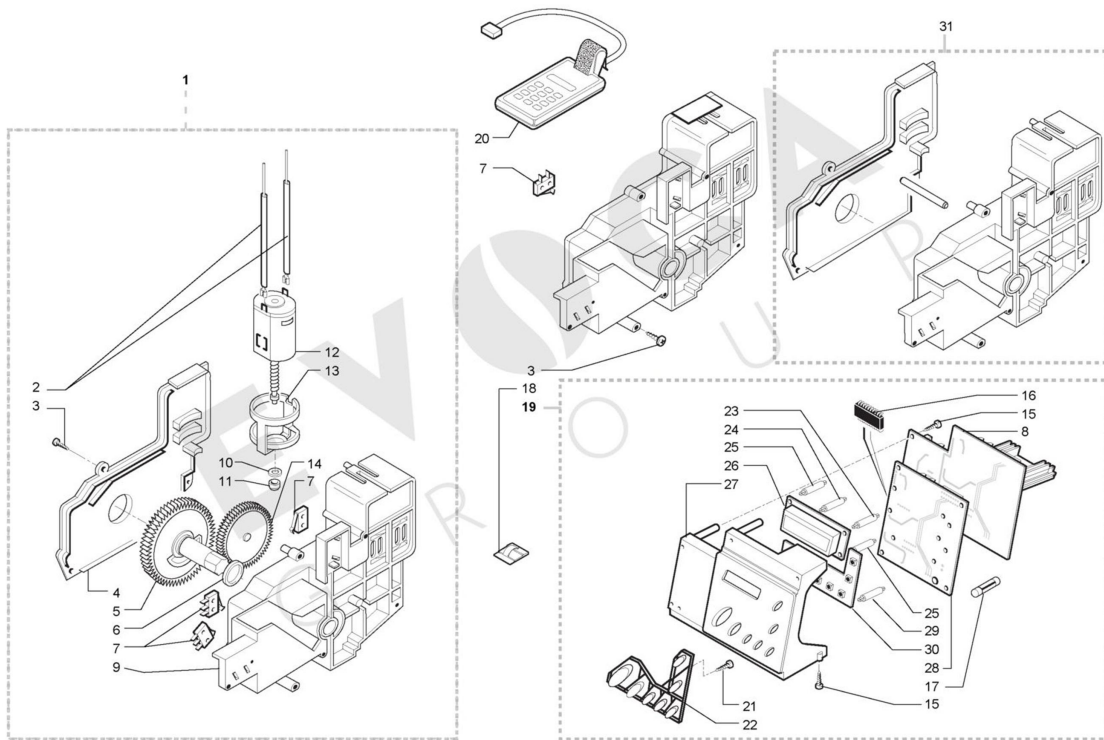

Model Machine

MACSAE018

SAECO ROYAL COFFEE BAR

Web Pos. Foto Item - Replace by Description



*Press - CTRL + CLICK go to item in a new window
Натисніть - Ctrl + права кнопка миші щоб відкрити запчастину в новому вікні*



1



9120.018.150

RATIOMOTOR ASS.WITH TUBE GREY
AS.RAC.TEFLON+DADO+PROT.2X4 L=250MM



1

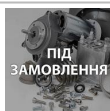

9120.029.150

RATIOMOTOR ASS.+TUBE GREY UL
RATIOMOTOR ASS.+TUBE GREY UL



2



0301.812

4POLES CONNECT.CUPWARMER MAGICASSY.
CONNECTOR ASS. 4 POLE CUPWARMER



2

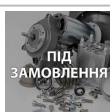

0341.809

CONNECTOR 4 POLES CUPWARMER ULASSY.
CONNECTOR 4 POLES CUPWARMER UL ASSY.



3



129670202

TCB PANELVIT SCREW 3,5X16 TESTA D=8 ZNP
TCB PANELVIT SCREW 3,5X16 TESTA D=8 ZNP



4



17000719

GREY RATIOMOTOR LID RYL
GREY RATIOMOTOR LID RYL



5



9121.069.150

GEAR Z=108 FOR MOUNTING PLATEM4000
INGRANAG.Z=108 PIASTRA MONT.M4000 GRIGIO



6



9161.368

MYLAR WASHER FOR RATIOMOTOR
RONDELLA MYLAR X MOTORIDUTTORE



7



NE05.038

MICROSWITCH 30V 0.3A
MICROINTERRUTTORE



8



0314.829.00A

POWER CARD ROYAL PROFESSIONAL230V
SCHEMA POWER ROYAL PROFESS.230V



8



0314.829.00F

POWER CARD ROYAL PROFESSIONAL120V
POWER CARD ROYAL PROFESSIONAL 120V



9

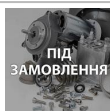

11027899

GREY RATIOMOTOR CASING W/DUCTV2 ASSY.
GREY RATIOMOTOR CASING W/DUCT V2 ASSY.



10



























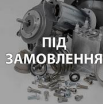

148380200

BAKELIZZATE WASHER D=5,5
BAKELIZZATE WASHER D=5,5

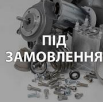
Model Machine

MACSAE018













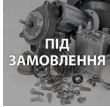

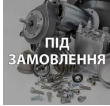

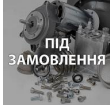



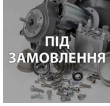

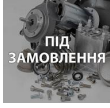

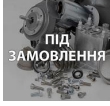
SAECO ROYAL COFFEE BAR

| | | | | |
|--|----|---|---------------------|--|
|  | 11 |  | 9121.046 | BRONZE SINTERED BUSH FOR MOTORRATIOMOT. <i>BRONZE SINTERED BUSH FOR MOTOR RATIOMOT.</i> |
|  | 12 |  | 11005214 | MOTOR FOR RATIOMOTOR ASSY. <i>MOTOR FOR RATIOMOTOR P124 ASSY</i> |
|  | 13 |  | 9121.044 | ANTIVIBRATION FOR MOTOR <i>ANTIVIBRANTE X MOTORE</i> |
|  | 14 |  | 9121.042 | GEAR Z=12/90 <i>INGRANAGGIO Z.12/90 PREZZO NUOVO 0,33</i> |
|  | 15 |  | U140.004 | PANELVIT TCB 3,0X12 DIN 7505 BGAL <i>PANELVIT TCB 3,0X12 DIN 7505 B ZNP</i> |
|  | 16 |  | 0334.807 | MICRO ROYAL PROF.N.S.V3.68/FB3A ST <i>MICRO ROYAL PROF.N.S.V3.68/F</i> |
|  | 17 |  | 184950300 | FUSE T32 M.AMP.5X20 DELAYED <i>FUSE T32 M.AMP.5X20 DELAYED</i> |
|  | 18 |  | NE17.002 | ADH.CABLE RETAI.ROUND CABLE D=10MM <i>ADH.CABLE RETAI.ROUND CABLE D=10MM</i> |
|  | 19 |  | 0341.R01.77A | SPARE WHOLE ELECTRONICS <i>SPARE WHOLE ELECTRONICS</i> |
|  | 19 |  | 0341.R02.77A | SPARE WHOLE ELECTRONICS STD <i>RIC.ASS.EL.ROYAL COFFEE BAR</i> |
|  | 19 |  | 0341.R03.77F | SPARE WHOLE ELECTRONICS <i>SPARE WHOLE ELECTRONICS</i> |
|  | 20 |  | 20000490 | KIT PROGRAMMER SERKIT SSC2 <i>KIT PROGRAMMAZIONE SERKIT</i> |
|  | 21 |  | U117.001 | SCREW AUT.PT TCB 2.5X006 WN 1442 ZNP <i>SCREW AUT.PT TCB 2.5X006 WN 1442</i> |
|  | 22 |  | 0314.012.710 | TOUCH PANEL FOR PROFESS. GREY <i>TOUCH PANEL FOR PROFESS. GREY</i> |

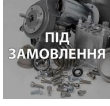
Model Machine

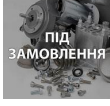
MACSAE018

SAECO ROYAL COFFEE BAR

| | | | | |
|--|----|---|--------------|---|
|  | 22 |  | 0314.012.760 | TOUCH PANEL FOR PROFESSIONAL BLUE <i>TOUCH PANEL FOR PROFESSIONAL BLUE</i> |
|  | 23 |  | NL04.005 | RICHCO SPACER MSPM-5-01 BD <i>RICHCO SPACER MSPM-5-01 BD</i> |
|  | 24 |  | NL04.004 | RICHCO SPACER MSPM-7-01 BK <i>RICHCO SPACER MSPM-7-01 BK</i> |
|  | 25 |  | NL04.006 | RICHCO SPACER MSPM-6-01 <i>RICHCO SPACER MSPM-6-01</i> |
|  | 26 |  | 0347.816 | DISPLAY FOR ROYAL REDESIGN <i>DISPLAY FOR ROYAL REDESIGN</i> |
|  | 27 |  | 0341.A10.77F | ELECT.ASS.COFFE BAR UL STD64 SILVER <i>ELECT.ASS.COFFE BAR UL STD64 SILVER</i> |
|  | 27 |  | 11006544 | SILVER ELECTRONIC SUPPORT PROF.+ LENS <i>SILVER ELECTRONIC SUPPORT PROF.+ LENS</i> |
|  | 27 |  | 11009991 | SILVER ELECTRONIC SUPPORT PROF.UL + LENS <i>SILVER ELECTRONIC SUPPORT PROF.UL + LENS</i> |
|  | 28 |  | 0341.804 | CPU CARD PROFESSIONAL N.S.STD61 <i>SCHEDA CPU FWA STD 64</i> |
|  | 28 |  | 0341.805 | CPU CARD PROFESSIONAL N.S.ITA65 <i>SCHEDA CPU FWA ITA 65</i> |
|  | 29 |  | NL04.003 | RICHCO SPACER MSP-9-01 <i>RICHCO SPACER MSP-9-01</i> |
|  | 30 |  | 0314.A07 | CARD ASS. PROFESSIONAL TOUCH PANEL <i>ASS.SCHEDA TASTIERA PROFESSI</i> |
|  | 31 |  | 20007052 | SPARES KIT GEARS FOR RATIOMOTOR RYL <i>SPARES KIT GEARS FOR RATIOMOTOR RYL</i> |

Model Machine

MACSAE018

SAECO ROYAL COFFEE BAR

MACSAE018.T.0005

TAVOLA NR. 5 - ARTICOLO SAECO ROYAL COFFEE BAR

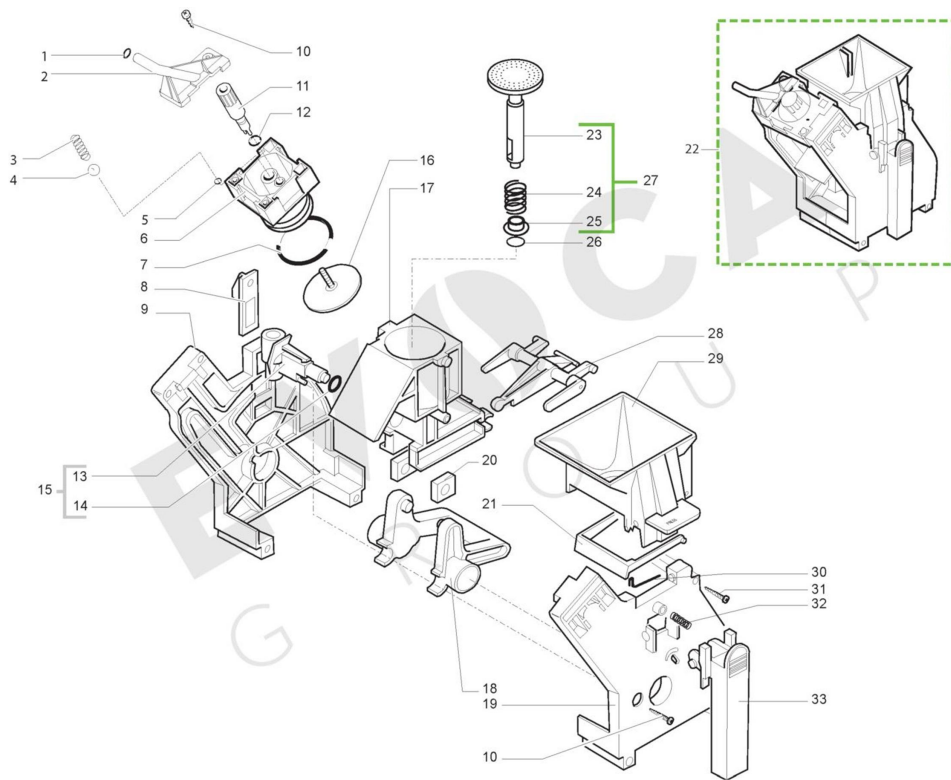

Model Machine

MACSAE018

SAECO ROYAL COFFEE BAR

Web Pos. Foto Item - Replace by Description



*Press - CTRL + CLICK go to item in a new window
Натисніть - Ctrl + права кнопка миші щоб відкрити запчастину в новому вікні*



1



NM02.017

OR ORM 0055-15 TERMOIL
OR ORM 0055-15 TERMOIL



2



9161.034.150

GREY COFFEE OUTLET SLEEVE
MANICOTTO USCITA CAFFE' GRIG



3



9161.222

SS.CONICAL SPRING
MOLLA CONICA



4

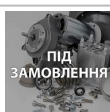

9991.168

GLASS SPHERE D.5 MM
SFERA IN VETRO D.5 MM



5

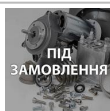

NM02.013

OR ORM 0080-15 TERMOIL
OR ORM 0080-15 TERMOIL



6



9161.193.150

GREY BREW UNIT COUNTERPISTON M5000
CONTROPISTONE X GRUPPO GRIGI



7



NM01.044

OR ORM 0320-40 SILICONE PTFE/FDA
OR ORM 0320-40 SILICONE PTFE



8



9161.067.150

GREY BREW UNIT COUPLING PLATE
PIASTRINA X AGGANCIIO GRUPPO CAFFE'GRIGIO



9



9161.070.150

GREY BREW UNIT REAR PLATE M5000
PIASTRA POSTERIORE GRUPPO CAFFE' GRIGIO



10



U140.019

SCREW TCB TORX 10 3X16 PLAST SS
PANELVIT TCB 3,0X16 DIN 7505



11



227470150

PIN BLACK ASS.FOR PERCOLATOR
PIN BLACK ASS.FOR PERCOLATOR



11

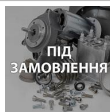

227470159

PIN GREY ASS.FOR PERCOLATOR
PIN GREY ASS.FOR PERCOLATOR



12



















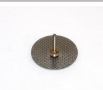



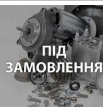





NM02.006

OR R5 TERMOIL
OR R5 EPDM

Model Machine

MACSAE018

















SAECO ROYAL COFFEE BAR

| | | | | |
|--|----|---|--------------|---|
|  | 13 |  | 9161.064.150 | ВХІДНИЙ КЛАПАН ЗАВАРЮВАЛЬНОГО БЛОКУ КАВОВАРКИ SAECO ПРО... <i>MANICOTTO ENTRATA ACQUA GRUP.CAF.GRIGIO CON OR NM02.007 - F...</i> |
|  | 14 |  | NM02.007 | OR 2025 IN TERMOIL <i>OR 2025 TERMOIL</i> |
|  | 15 |  | 0301.R04.150 | GREY WATER INLET SLEEVE BREW UNIT ASSY. <i>GREY WATER INLET SLEEVE BREW UNIT ASSY.</i> |
|  | 16 |  | 223740300 | PERCOLATOR DE=35,8 ASSY. <i>AS.DOCCIA DE=35,8 C/VITE E D</i> |
|  | 16 |  | 9160.075 | PERCOLATOR DE=35,8 ELFO ASSY. <i>PERCOLATOR DE=35,8 ELFO ASSY.</i> |
|  | 17 |  ПІД ЗАМОВЛЕННЯ | 11005779 | GREY COFFEE CONTAINER FOR BREWUNIT ASSY <i>GREY COFFEE CONTAINER FOR BREWUNIT ASSY</i> |
|  | 18 |  | 9161.066.150 | GREY BREW UNIT ELBOW SHAFT M5000 <i>ALBERO A GOMITO X GRUPPO GRIGIO</i> |
|  | 19 |  | 9161.071.150 | GREY BREW UNIT FRONT PLATE M5000 <i>9161.071.150</i> |
|  | 20 |  | 9161.094.050 | BLACK BREW UNIT DRILLED BLOCK <i>BLACK BREW UNIT DRILLED BLOCK</i> |
|  | 21 |  | 9161.060.150 | GREY SCRAPER FOR BREW UNIT M5000 <i>RASATORE X GRUPPO GRIGIO</i> |
|  | 22 |  | 11004180 | BLACK BREW UNIT NEWL <i>BLACK BREW UNIT NEW MAGIC-ROYAL</i> |
|  | 23 |  | 9161.306.150 | GREY BREW UNIT INTEGRAL PISTON8GR.ASSY. <i>ASS.PISTONE INTEGRALE GRIGIO</i> |
|  | 24 |  | 9161.198 | SS.8GR.BREW UNIT PISTON SPRING <i>SS.8GR.BREW UNIT PISTON SPRING</i> |
|  | 25 |  | 9161.191 | WHITE 8GR.-12GR.BREW UNIT PISTON BUSH <i>BOCCOLA X PISTONE NEUTRO</i> |

Model Machine

MACSAE018

SAECO ROYAL COFFEE BAR

| | | | | |
|--|----|--|--------------|---|
|  | 26 |  | NM02.018 | OR ORM 0090-25 TERMOIL <i>OR ORM 0090-25 TERMOIL</i> |
|  | 27 |  | 9161.343.150 | GREY 8GR.BREW UNIT NTEGR.PISTON GEN.ASSY <i>ASS.PISTONE INTEGRALE</i> |
|  | 28 |  | 9161.065.150 | GREY CONNECTING ROD BREW UNIT8GR. <i>GREY CONNECTING ROD BREW UNIT 8GR.</i> |
|  | 29 |  | 9161.123.150 | GREY HOPPER COFF.BREW UNIT S/SCR.M5000 <i>TRAMOGGIA GRUPPO CAFFE' GRIGIO SER.PRESS</i> |
|  | 30 |  | 9161.046 | ПРУЖИНА ВОРОНКИ ЗАВАРОЧНОГО БЛОКА ДЛЯ КОФЕМАШИН PHILIPS ... <i>MOLLA X RASATORE GRUPPO</i> |
|  | 31 |  ПІД ЗАМОВЛЕННЯ | U109.026 | SS.SCREW AUT.TCB 3,5X19 DIN 7981 C <i>SS.SCREW AUT.TCB 3,5X19 DIN 7981 C</i> |
|  | 32 |  | 9161.045 | SS BREW UNIT HANDGRIP SPRING M5000 <i>MOLLA X IMPUGNATURA GRUPPO</i> |
|  | 33 |  | 9161.069.150 | GREY BREW UNIT HANDGRIP M5000 <i>IMPUGNATURA X GRUPPO GRIGIO</i> |