

Model Machine

MACSAE305

КАВОВИЙ АВТОМАТ OCS PHEDRA EVO 9GR 1C3 230/50 RI

MACSAE305.T.0001

TAVOLA NR. 1 - ARTICOLO КАВОВИЙ АВТОМАТ OCS PHEDRA EVO 9GR 1C3 230/50 RI
BLK (10004854/10000068)

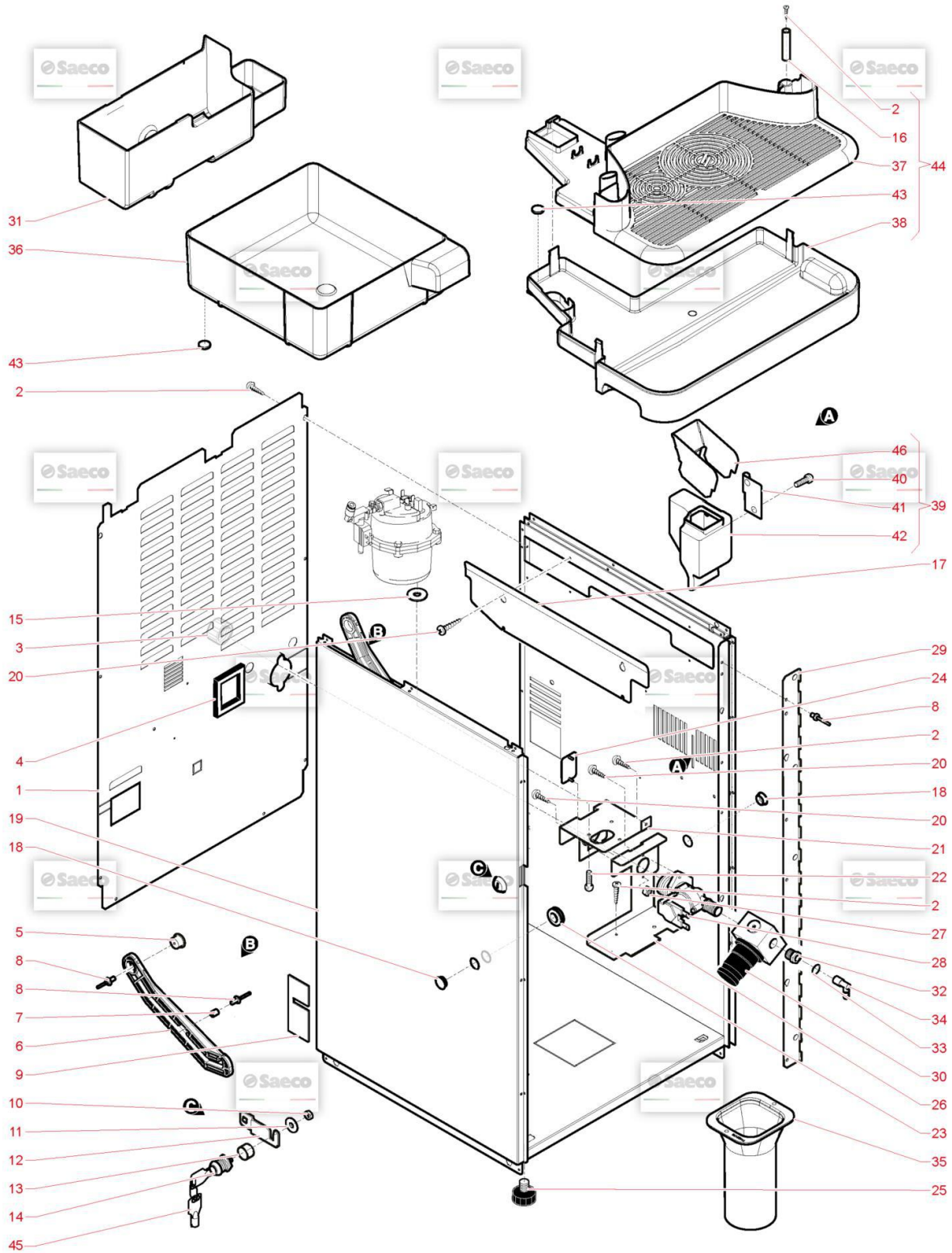

Model Machine

MACSAE305

КАВОВИЙ АВТОМАТ OCS PHEDRA EVO 9GR 1C3 230/50 RI

Web Pos. Foto Item - Replace by Description



Press - CTRL + CLICK go to item in a new window
Натисніть - Ctrl + права кнопка миші щоб відкрити запчастину в новому вікні



1



11033288

PHEDRA REAR PANEL
 PHEDRA REAR PANEL



2



U116.006

SCREW AUT.PT TCB 3,5X12 WN 1441 ZNP
 VITE AUT.PT TCB 3,5X12 WN 1441 ZNP



3



NV03.002

CAP 3/4 "KAPSTO 800R 3/4"
 "CAP 3/4 "KAPSTO 800R 3/4""



4



9111.088

ADHESIVE SEAL FOR ASPIRATOR
 ADHESIVE SEAL FOR ASPIRATOR



5

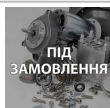

11033447

BUSH LEVER ROOF
 BUSH LEVER ROOF



6

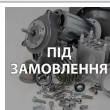

11033773

DOOR STIRRUP UPPER 5P07
 DOOR STIRRUP UPPER 5P07



7

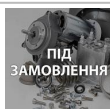

11009319

BUSH FOR BRACKET UPPER DOOR
 BUSH FOR BRACKET UPPER DOOR



8

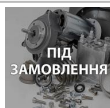

NF11.022

EXPANSION RIVET D=2,8X8 ALU. BLACK
 EXPANSION RIVET D=2,8X8 ALU. BLACK



9

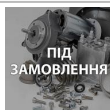

11013519

SPACE FOR PANEL PHEDRA
 SPACE FOR PANEL PHEDRA



10



U302.004

NUT HEXAGONAL M6 UNI 5588
 DADO ESAGONALE M6 UNI 5



11



U208.006

TOOTHED WASHER 6,4X11 UNI 3703
 ROSETTA DENT. 6,4X11 UNI 3



12





















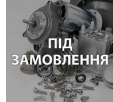

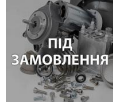

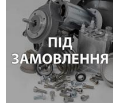

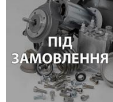
1813.105

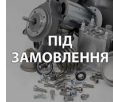
LEVER FOR LOCK
 LEVER FOR LOCK

Model Machine

MACSAE305

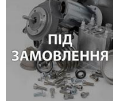













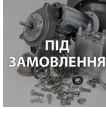

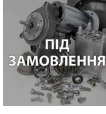





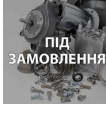

КАВОВИЙ АВТОМАТ OCS PHEDRA EVO 9GR 1C3 230/50 RI

	13		1813.126	SPACER SPACER
	14		NV02.249	LOCK MERONI 3351B21 X DISTRIB. LOCK MERONI 3351B21 X DISTRIB.
	15		9111.501	INSULATION WASHER INSULATION WASHER
	16		11033561	STOP EXTRACTION TANK STOP EXTRACTION TANK
	17	 ПІД ЗАМОВЛЕННЯ	11033442	CARTER FOR HARNESS PHEDRA EVO CARTER FOR HARNESS PHEDRA EVO
	18	 ПІД ЗАМОВЛЕННЯ	12001971	PLUG BLK F.15,9-SP.MAX 1,6 PLUG BLK F.15,9-SP.MAX 1,6
	19	 ПІД ЗАМОВЛЕННЯ	11035371	FRAME PHEDRA EVO ASS.TELAIO FORO DX-SX PHEDRA EVO
	20	 ПІД ЗАМОВЛЕННЯ	12002160	SCREW TMTPH2 3,5X9,5 F ZNP ISO4759/1 SCREW TMTPH2 3,5X9,5 F ZNP ISO4759/1
	21	 ПІД ЗАМОВЛЕННЯ	11033289	PHEDRA BOILERS SUPPORT PLATE PHEDRA BOILERS SUPPORT PLATE
	22		U046.005	SCREW TE M5,0X10 WITH WASHER SCREW TE M5,0X10 WITH WASHER
	23		NE16.002	GROMMET D.11X20,5XH.7 GROMMET D.11X20,5XH.7
	24	 ПІД ЗАМОВЛЕННЯ	11034232	CLOSURE PLATE WATER SUPPLY CLOSURE PLATE WATER SUPPLY
	25		NV01.015	FOOT D.22 H.18 M6 PIEDINO D.22 H.18 M6

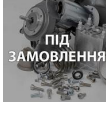
Model Machine

MACSAE305













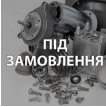



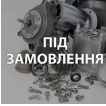

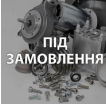

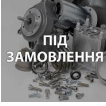

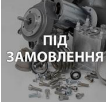
КАВОВИЙ АВТОМАТ OCS PHEDRA EVO 9GR 1C3 230/50 RI

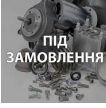
	26		11033602	МЕТАЛЕВИЙ СУПОРТ ПОМПИ <i>PUMP SUPPORT PLATE</i>
	27		U324.006	ШАЙБА М4 <i>NUT M4 FLANGED INDENTED BASE</i>
	28		11008834	SOLENOID VALVE <i>SOLENOID VALVE</i>
	29		11033431	HINGE FOR DOOR <i>HINGE FOR DOOR</i>
	30		NV99.007	ЦЕНТРАЛЬНИЙ КЛАПАН ВОДИ 1BAR 1/4 MRABIT 52 PHILIPS SAECO 9965... <i>PRESS. REDUCER .1BAR 1/4 MRABIT 52</i>
	31		11033809	DRAWER TRUST <i>CASSETTO FONDI SUPERIORE PHEDRA EVO</i>
	32		9181.404	REDUCTION MF 1/4"X1/8" TEA <i>REDUCTION MF 1/4"X1/8" TEA</i>
	33		140321961	ПРОКЛАДКА O-RING ДЛЯ КАВОМАШИНИ SAECO 2031 TERMOIL <i>OR 2031 IN TERMOIL</i>
	34		11001054	СОЕДИНИТЕЛЬНЫЙ УГОЛОК 90° К НАСОСУ P0049/B PHILIPS SAECO 996... <i>BLK PUMP OUTLET 90° CONNECTOR P0049/B</i>
	35		11032178	COFFEE CONVEY <i>COFFEE CONVEY</i>
	36		11033365	DUMP BOX PHEDRA EVO <i>DUMP BOX PHEDRA EVO</i>
	37		11033368	GRILL WATER RECOVER BOX <i>GRILL WATER RECOVER BOX</i>
	37		11034997	GRILL WATER RECOVER BOX CSA BLK <i>GRILL WATER RECOVER BOX CSA BLK</i>

Model Machine

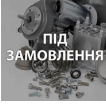
MACSAE305

КАВОВИЙ АВТОМАТ OCS PHEDRA EVO 9GR 1C3 230/50 RI

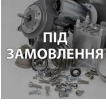
	38		11033367	ЧОРНИЙ ПІДДОН ЗБОРУ КРАПЕЛЬ SAECO 11034996 <i>WATER RECOVER BOX</i>
	38	 ПІД ЗАМОВЛЕННЯ	11034996	WATER RECOVER BOX CSA BLK <i>WATER RECOVER BOX CSA BLK</i>
	39	 ПІД ЗАМОВЛЕННЯ	11013321	COIN CASE PHEDRA <i>COIN CASE PHEDRA</i>
	39	 ПІД ЗАМОВЛЕННЯ	11033785	COIN CASE PHEDRA EVO <i>ASS.CASSA MONETE PHEDRA EVO</i>
	40	 ПІД ЗАМОВЛЕННЯ	U044.018	SCREW TSPC M5,0X8 UNI 7688 GALV. <i>SCREW TSPC M5,0X8 UNI 7688 GALV.</i>
	41	 ПІД ЗАМОВЛЕННЯ	11012740	PLATE FOR COIN BOX PHEDRA <i>PLATE FOR COIN BOX PHEDRA</i>
	42	 ПІД ЗАМОВЛЕННЯ	11011322	COIN CASE 5P07 <i>COIN CASE 5P07</i>
	43	 ПІД ЗАМОВЛЕННЯ	9991.189	MAGNET D.9,5X2 2000 GAUSS <i>MAGNET D.9,5X2 2000 GAUSS</i>
	44		11035038	ЧОРНИЙ ПІДДОН ЗБОРУ КРАПЕЛЬ SAECO PHEDRA EVO <i>ASS. VASCA RACCOGLIGOCCE PHEDRA</i>
	44	 ПІД ЗАМОВЛЕННЯ	11035039	DRIP TRAY PHEDRA EVO CSA <i>ASS.VASCA RACCOGLIGOCCE PHEDRA EVO CSA</i>
	45		1602.R02	KEY FOR MERONILOCK <i>KEY FOR MERONILOCK</i>
	46	 ПІД ЗАМОВЛЕННЯ	11033597	BOX MONEY SLIDE <i>SCIVOLO CASSA MONETE</i>

Model Machine

MACSAE305

КАБОВИЙ АВТОМАТ OCS PHEDRA EVO 9GR 1C3 230/50 RI

MACSAE305.T.0002



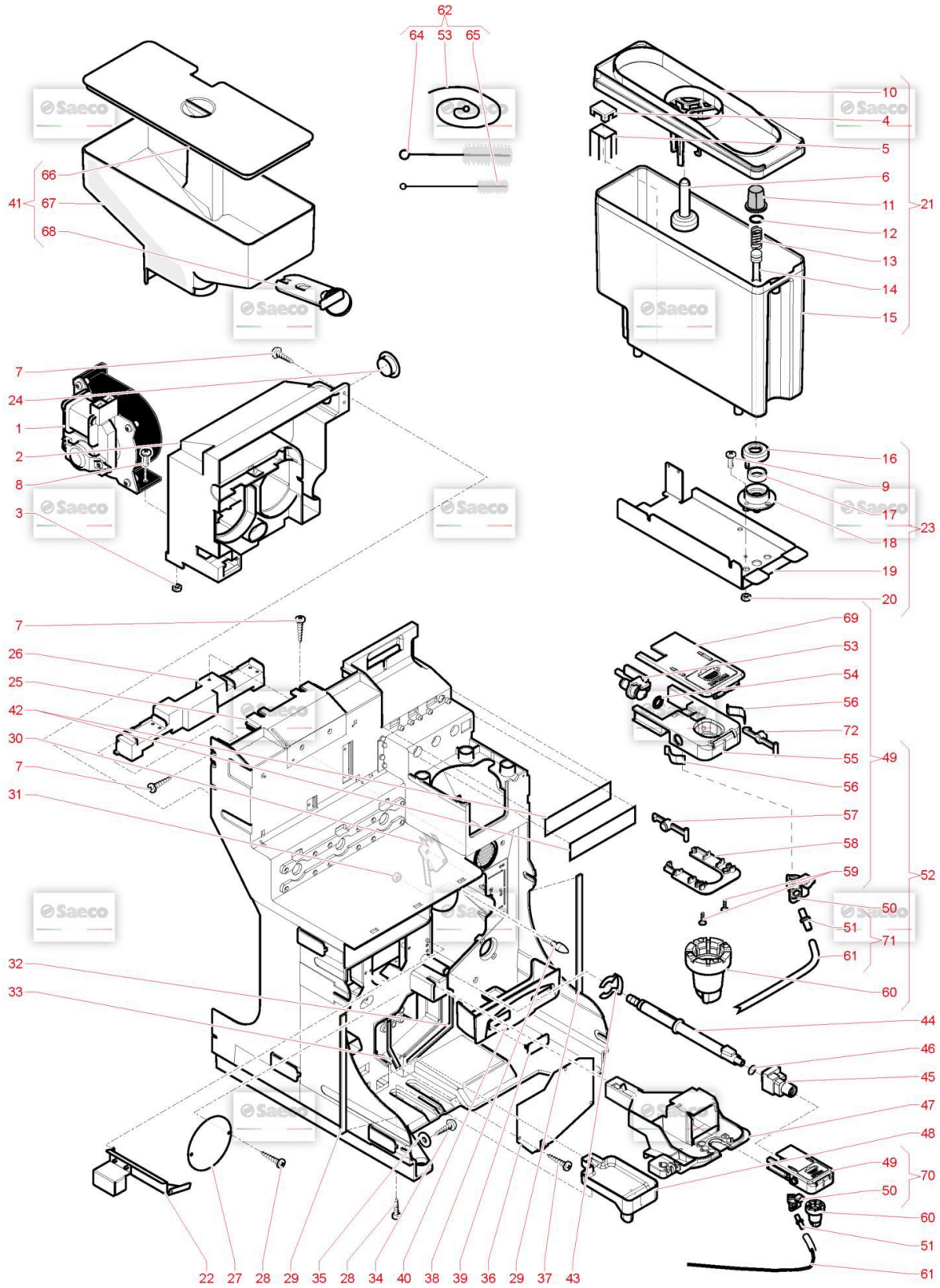

















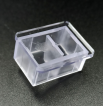



TAVOLA NR. 2 - ARTICOLO КАБОВИЙ АВТОМАТ OCS PHEDRA EVO 9GR 1C3 230/50 RI
BLK (10004854/10000068)

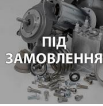

Model Machine

MACSAE305



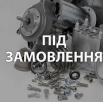























КАВОВИЙ АВТОМАТ OCS PHEDRA EVO 9GR 1C3 230/50 RI

Web	Pos.	Foto	Item - Replace by	Description
				<i>Press - CTRL + CLICK go to item in a new window Натисніть - Ctrl + права кнопка миші щоб відкрити запчастину в новому вікні</i>
	1		9121.009.00A	MOTOR WITH FAN 230V MOTORE CON VENTOLA 230V
	1		9121.009.00F	MOTOR WITH FAN 120V MOTOR WITH FAN 120V
	2		11007018	5P07 SOLUBLES MOTORS SUPPORT 5P07 SOLUBLES MOTORS SUPPORT
	3		U324.006	ШАЙБА M4 NUT M4 FLANGED INDENTED BASE
	4		9161.050.230	NAT/TRANSF.FLOATING SPACE PLUGMAGIC TAPPO X GALLEGGIANTE SUPERAUTOM.
	5		9161.112.150	GREY LEVEL FLOAT GALLEGGIANTE DI LIVELLO GRIGIO
	6		11033698	VISUAL FLOAT FOR TANK VISUAL FLOAT FOR TANK
	7		U110.005	SCREW AUT.TCB 3,9X9,5 DIN 7981F VITE AUT.TCB 3,9X9,5 DIN 798
	8		12002039	SCREW TCBD TORX 20 M4X12 ZN-B VITE TCBD TORX 20 M4X12 ZN-B
	8		U046.007	SCREW TEFZ M4,0X12 GALV. SCREW TEFZ M4,0X12 GALV.
	9		U044.009	SS SCREW TSPC M3,0X8 UNI 7688 VITE TSCP M3,0X8 UNI 7688 INO
	10		11033590	COVER TANK COVER TANK

Model Machine

MACSAE305











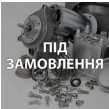

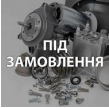

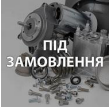

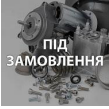



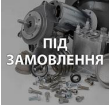



КАВОВИЙ АВТОМАТ OCS PHEDRA EVO 9GR 1C3 230/50 RI

	11		224640200	БІЛИЙ ПЛАСТИКОВИЙ ФІЛЬТР У КОНТЕЙНЕР ВОДИ SAECO 996530029115 <i>EXTERNAL FILTER FOR WATER CONTAINER ASSY</i>
	12		140324362	OR ORM 0060-30 SILICONE <i>OR METRIC 0060-30 IN SILICONE</i>
	13		126764718	SS WATER CONTAINER VALVE SPRING <i>SS WATER CONTAINER VALVE SPRING</i>
	14		147660562	GREY PISTON FOR WATER CONTAINER VALVE <i>GREY PISTON FOR WATER CONTAINER VALVE</i>
	15		11033589	TANK PHEDRA EVO <i>TANK PHEDRA EVO</i>
	16		0701.031.150	GREY WATER VALVE GACO DIM 14 SEAL COVER <i>SEAL COVER GREY</i>
	17		145842900	NBR WATER CONT. VALVE GACO DIM14 SEAL <i>NBR WATER CONT. VALVE GACO DIM14 SEAL</i>
	18		0701.014.150	GREY WATER VALVE GACO DIM 14 SEAL CONT. <i>GREY WATER VALVE GACO DIM 14 SEAL CONT.</i>
	19		11034296	PLATE TANK SUPPORT BLK <i>PLATE TANK SUPPORT BLK</i>
	20		U324.005	NUT M3 FLANGED INDENTED BASE <i>DADO M3 FLANGIATO BASE DENTELLATA</i>
	21		11033803	TANK PHEDRA EVO <i>TANK PHEDRA EVO</i>
	22		11034489	SAFETY CARTER BLK <i>SAFETY CARTER BLK</i>
	23		11033805	TANK SUPPORT <i>TANK SUPPORT</i>

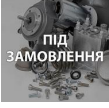
Model Machine

MACSAE305

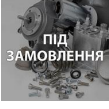

























КАВОВИЙ АВТОМАТ OCS PHEDRA EVO 9GR 1C3 230/50 RI

	24		12001070	POLYCAP COVER LPN600-053-IDPE <i>POLYCAP COVER LPN600-053-IDPE</i>
	25		11033772	PHEDRA EVO MAIN ASSEMBLING PLATE <i>PHEDRA EVO MAIN ASSEMBLING PLATE</i>
	26		11008350	UPPER HINGES PLATE <i>UPPER HINGES PLATE</i>
	27		9111.405.060	MIXER HOLE CAP BROWN <i>MIXER HOLE CAP BROWN</i>
	28		U116.006	SCREW AUT.PT TCB 3,5X12 WN 1441 ZNP <i>VITE AUT.PT TCB 3,5X12 WN 1441 ZNP</i>
	29		11032541	ASIDE PANELS' SPECIAL SEAL <i>ASIDE PANELS' SPECIAL SEAL</i>
	30		NE05.018	MICROSWITCH <i>MICROINTERRUTTORE SAECO XCG5-81-P5</i>
	31		123160502	GALVANIZED NUT M5 HIGH UNI 5587-68 <i>GALVANIZED NUT M5 HIGH UNI 5587-68</i>
	32		11013140	SEAL FOR DRAIN VAIN PHEDRA L.115 <i>SEAL FOR DRAIN VAIN PHEDRA L.115</i>
	33		11009240	SEAL FOR DRAIN VAIN PHEDRA <i>SEAL FOR DRAIN VAIN PHEDRA</i>
	34		U109.013	SCREW TCB 3,5X13 UNI 6954 NIK <i>SCREW TCB 3,5X13 UNI 6954 NIK</i>
	35		U201.005	PLAIN WASHER 4,3X12 DIN 7349 GAL <i>PLAIN WASHER 4,3X12 DIN 7349 GAL</i>
	36		11008460	VAIN OF DRAIN COVER PLATE <i>VAIN OF DRAIN COVER PLATE</i>

Model Machine

MACSAE305















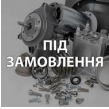







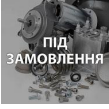

КАВОВИЙ АВТОМАТ OCS PHEDRA EVO 9GR 1C3 230/50 RI

	37		U142.008	PANELVIT TSP 3,5X12 DIN 7505 AGAL <i>PANELVIT TSP 3,5X12 DIN 7505 A GAL</i>
	38		9011.005	PEG FOR BOILER <i>PERNO X CALDAIA</i>
	39		9111.481.060	COLUMN CAP <i>COLUMN CAP</i>
	40		11007799	BOX MIXERS ASPIRATION 5P07 <i>BOX MIXERS ASPIRATION 5P07</i>
	41		11008835	COFFEE TANK ASSEMBLY 5P07 <i>COFFEE TANK ASSEMBLY 5P07</i>
	42		15001860	ETICHETTA ADESIVA 92X30MM PHEDRA <i>ETICHETTA ADESIVA 92X30MM PHEDRA</i>
	43		12001585	BURNISHED/STEEL D=10 SEEGER RING UNI7435 <i>BURNISHED/STEEL D=10 SEEGER RING UNI7435</i>
	44		11009476	TUBE FOR CAPPUCCINATORE <i>TUBE FOR CAPPUCCINATORE</i>
	45		11033391	CAPPUCCINATORE OUTPUT STEAM CONNECTOR <i>RACCORDO USCITA VAPORE CAPP.PHEDRA EVO</i>
	46		NM01.057	OR ORM 0050-20 IN SILICONE <i>OR ORM 0050-20 IN SILICONE</i>
	47		11033385	PHEDRA EVO NOZZLES SUPPORT <i>SUPPORTO EROGAZIONE PHEDRA EVO</i>
	48		11033363	ПІДДОН ЗЛИВУ ВОДИ ДЛЯ РУКИ PHEDRA EVO <i>WATER CONVEYOR</i>
	49		421941260042	КОРПУС КАПУЧІНАТОРА SAECO <i>BLK CAPPUCCINATORE S/SCR.V2 RYLO ASSY</i>

Model Machine

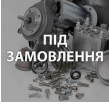
MACSAE305



















КАВОВИЙ АВТОМАТ OCS PHEDRA EVO 9GR 1C3 230/50 RI

	50		17000336	MILK INTAKE TUBE CONNECTOR RYL <i>MILK INTAKE TUBE CONNECTOR RYL</i>
	51		17001362	BLK MILK INTAKE TUBE CONNECT.INS.V2 RYL <i>BLK MILK INTAKE TUBE CONNECT.INS.V2 RYL</i>
	52		11034071	KIT CAPPUCCINATORE PHEDRA EVO <i>KIT CAPPUCCINATORE PHEDRA EVO</i>
	53		17000785	BLACK CAPPUC.INPUT MILK CONNECTOR RYL <i>BLACK CAPPUCCINATORE MILK CONNECTOR RYL</i>
	54		NM01.028	O-RING 106 SILICONE <i>OR 106 SILICONE</i>
	55		17000338	BLACK LEFT ENTRY CAPPUCCINAT.CASING RYL <i>BLACK LEFT ENTRY CAPPUCCINAT.CASING RYL</i>
	56		263235	TAPER SPRING <i>MOLLA CONICA INSERTO CAPPUC.</i>
	57		17000389	ЛІВА ЗАЦІПКА КАПУЧИНАТОРА <i>GREY LEFT CAPPUCCINATORE INSERT RYL</i>
	58		421941278272	НИЖНЯ СТІНКА КАПУЧИНАТОРА V2 RYL <i>BLK LOWER CAPPUCCINATORE LID V2 RYL</i>
	59		12000895	SCREW TSP TORX 10 3X10 PLAST.SS <i>SCREW TSP TORX 10 3X10 PLAST.SS</i>
	60		11033390	CAPPUCCINATORE OUTPUT MILK CONNECTOR <i>CAPPUCCINATORE OUTPUT MILK</i>
	61		11034305	SILICONE TUBE 3,5X6 L=640 MM <i>SILICONE TUBE 3,5X6 L=640 MM</i>
	62		11033704	КОМПЛЕКТ АКСЕСУАРІВ ДЛЯ ОБСЛУГОВУВАННЯ PHEDRA CAPPUCCIN... <i>SACK PHEDRA CAPPUCCINO EVO ACCESSORIES</i>

Model Machine

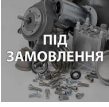
MACSAE305

КАВОВИЙ АВТОМАТ OCS PHEDRA EVO 9GR 1C3 230/50 RI

	63		1022.018	SCRAPER ASS.FOR CAPPUCINAT. TUBE ASS.RASCHIATORE X TUBO CAPPUCINO
	64		12000431	BRUSH D.12 BRUSH D.12
	65		12000430	BRUSH D.6 BRUSH D.6
	66		11007015	5P07 COFFEE CONTAINER COVER COPERCHIO CONT.CAFFE' IN GRANI 5P07 COFFEE CONTAINER COVER
	67		11007014	COFFEE CONTAINER 5P07 COFFEE CONTAINER 5P07
	68		11010736	ASS.GUILLOTINE COFFEE (1813.027) ASS.GUILLOTINE COFFEE
	69		263951	КРИШКА КАПУЧЧИНАТОРА TOP SPARE PARTS
	70		11035513	CAPPUCCINATORE V2 MILK INTAKETUBE ASS.CAPPUC.V2 E RAC.TUBO ASPIR.LATTE
	71		11034304	TUBE PINL.WONDER PHEDRA EVO ASS.TUBO PINL.WONDER PHEDRA EVO
	72		17000402	GREY RIGHT CAPPUCINATORE INSERT RYL GREY RIGHT CAPPUCINATORE INSERT RYL

Model Machine

MACSAE305

КАВОВИЙ АВТОМАТ OCS PHEDRA EVO 9GR 1C3 230/50 RI

MACSAE305.T.0003

TAVOLA NR. 3 - ARTICOLO КАВОВИЙ АВТОМАТ OCS PHEDRA EVO 9GR 1C3 230/50 RI
BLK(10004854/10000068)

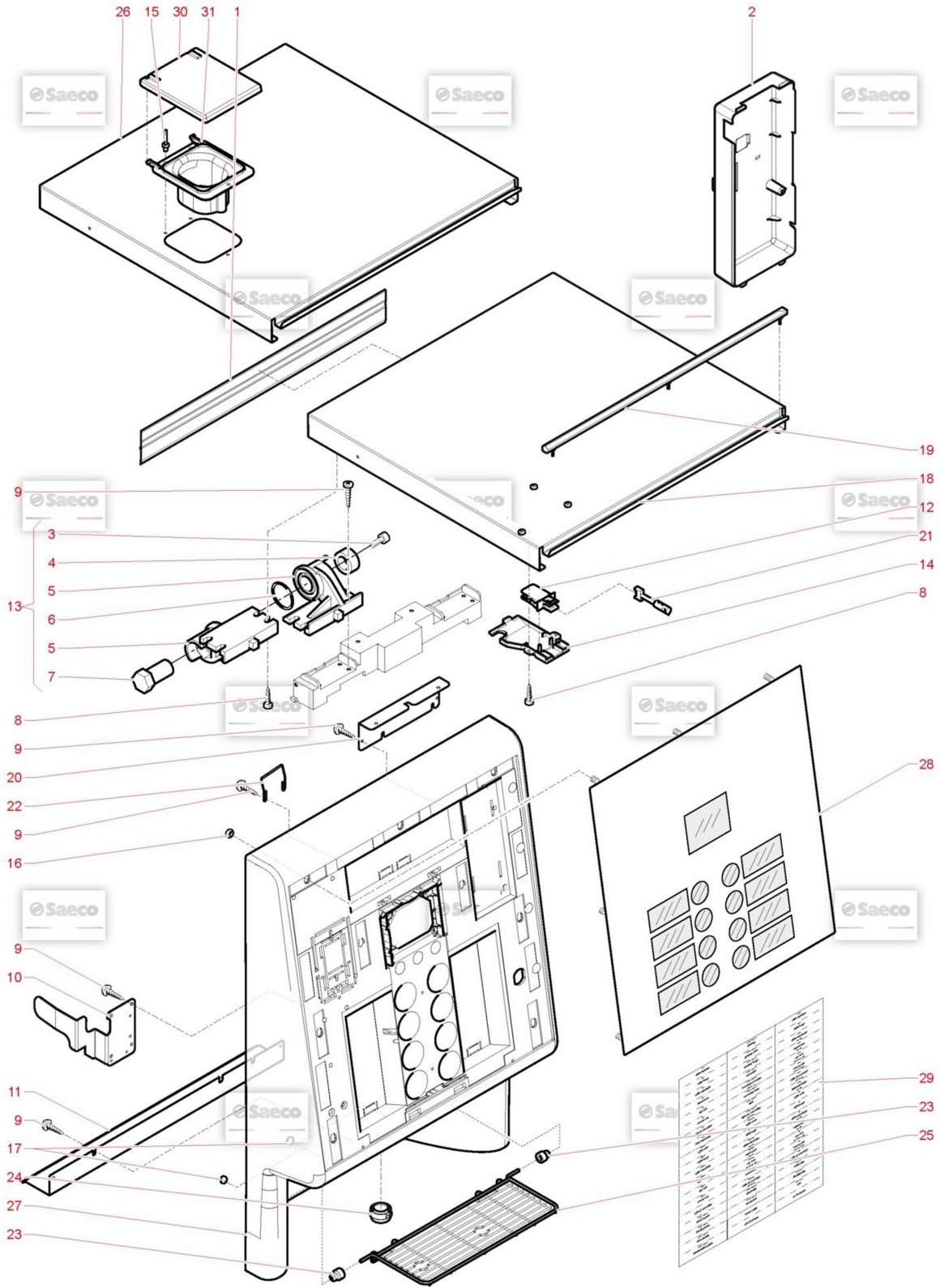

Model Machine

MACSAE305

КАВОВИЙ АВТОМАТ OCS PHEDRA EVO 9GR 1C3 230/50 RI

Web Pos. Foto Item - Replace by Description



Press - CTRL + CLICK go to item in a new window
Натисніть - Ctrl + права кнопка миші щоб відкрити запчастину в новому вікні



1



11012465

GUARNIZIONE DEFUSSO ACQUA X SPORTELLO
 UPPER DOOR SPECIAL SEAL FOR WATER



2



11033392

CARTER
 CARTER



3

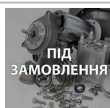

U023.019

SCREW TCEI M8X20 UNI 5931 ZIN
 SCREW TCEI M8X20 UNI 5931 ZIN



4

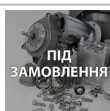

11010862

BUSH HINGE 5P07
 BUSH HINGE 5P07



5



11007023

HINGE FOR ROOF 5P07
 CERNIERA X TETTO 5P07 HINGE FOR ROOF 5P07



6

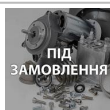

NM01.026

O-RING 121 SILICONE
 OR 121 SILICONE



7

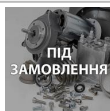

11008967

PIN FOR HINGE 5P07
 PIN FOR HINGE 5P07



8

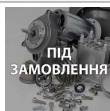

12002160

SCREW TMTPH2 3,5X9,5 F ZNP ISO4759/1
 SCREW TMTPH2 3,5X9,5 F ZNP ISO4759/1



9



U116.006

SCREW AUT.PT TCB 3,5X12 WN 1441 ZNP
 VITE AUT.PT TCB 3,5X12 WN 1441 ZNP



10



11034349

НАПРАВЛЯЮЧА ДВЕРЕЙ
 PLATE



11

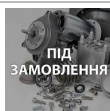

11034360

CARTER LED DOOR
 CARTER LED DOOR



12













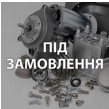





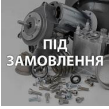

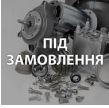

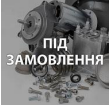

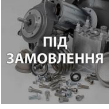

NE05.039

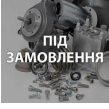
BIPOLAR MICROSWITCH
 MICROINTERRUTTORE BIPOLARE

Model Machine

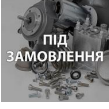
MACSAE305























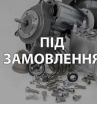

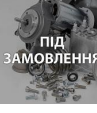
КАВОВИЙ АВТОМАТ OCS PHEDRA EVO 9GR 1C3 230/50 RI

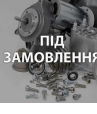
	12		NE05.061	MICROSWITCH CHERRY D413 .V3LD <i>MICROINT.BIPOLARE XTD 22AZ1</i>
	13		11008937	ASS.HINGE ROOF 5P07 <i>ASS.HINGE ROOF 5P07</i>
	14		11033774	SUPPORT FOR MICRO DOOR <i>SUPPORT FOR MICRO DOOR</i>
	15		NF11.022	EXPANSION RIVET D=2,8X8 ALU. BLACK <i>EXPANSION RIVET D=2,8X8 ALU. BLACK</i>
	16		U324.003	NUT M5 FLANGED INDENTED BASE <i>NUT M5 FLANGED INDENTED BASE</i>
	17		9991.189	MAGNET D.9,5X2 2000 GAUSS <i>MAGNET D.9,5X2 2000 GAUSS</i>
	18		11033400	COVER PHEDRA EVO BLK <i>COPERCHIO PHEDRA EVO BLK</i>
	19		11033568	GASKET COVER PHEDRA EVO <i>GASKET COVER PHEDRA EVO</i>
	20		11034280	CARTER FOR HARNESS DOOR BLK <i>CARTER FOR HARNESS DOOR BLK</i>
	21		11028411	KEY <i>KEY</i>
	22		11007640	SPRING FOR UPPER DOOR MICROSWITCH <i>SPRING FOR UPPER DOOR MICROSWITCH</i>
	23		11033697	BUSH FIXING GRILL <i>BOCCOLA FISSAGGIO GRIGLIA</i>
	24		11033420	HOT WATER OUT CONE <i>HOT WATER OUT CONE</i>

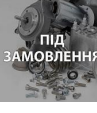
Model Machine

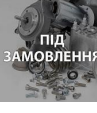
MACSAE305

КАВОВИЙ АВТОМАТ OCS PHEDRA EVO 9GR 1C3 230/50 RI

	25		11033395	РЕШИТКА SAECO PHEDRA EVO <i>GRILL FOR PHEDRA EVO</i>
	26		11033606	COVER X TANK BLK <i>COVER X TANK BLK</i>
	27		11033364	PHEDRA EVO FRONT DOOR <i>PHEDRA EVO FRONT DOOR</i>
	27		11034995	PHEDRA EVO FRONT DOOR BLK <i>PORTA ANTERIORE PHEDRA EVO BLK</i>
	28		20000056	KIT RIC. TASTIERA CAPACITIVAPHEDRA EVO <i>KIT RIC. TASTIERA CAPACITIVA PHEDRA EVO</i>
	29		15004381	ТАБЛИЧКА З НАЗВАМИ НАПОЇВ ITA <i>FOGLIO ETICH.PROD.TAST.CAPACITIVA ITA</i>
	29		15004382	PRODUCTS LABEL'S SHEET CRISTALLO EVO ENG <i>PRODUCTS LABEL'S SHEET CRISTALLO EVO ENG</i>
	29		15004383	PRODUCTS LABEL'S SHEET CRISTALLO EVO FRA <i>PRODUCTS LABEL'S SHEET CRISTALLO EVO FRA</i>
	29		15004384	PRODUCTS LABEL'S SHEET CRISTALLO EVO DE <i>PRODUCTS LABEL'S SHEET CRISTALLO EVO DE</i>
	29		15004385	PRODUCTS LABEL'S SHEET CRISTALLO EVO SPA <i>PRODUCTS LABEL'S SHEET CRISTALLO EVO SPA</i>
	29		15004386	PRODUCTS LABEL'S SHEET CRISTALLO EVO POR <i>FOGLIO ETICH.PROD.TAST.CAPACITIVA POR</i>
	29		15004387	PRODUCTS LABEL'S SHEET CRISTALLO EVO NL <i>PRODUCTS LABEL'S SHEET CRISTALLO EVO NL</i>
	29		15004670	ADD.LABEL'S SHEET CAPACITIVE KEYBOARD <i>ADD.LABEL'S SHEET CAPACITIVE KEYBOARD</i>

Model Machine

MACSAE305

КАБОВИЙ АВТОМАТ OCS PHEDRA EVO 9GR 1C3 230/50 RI



30

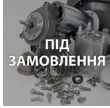

11033587

COVER FUNNEL TANK
COVER FUNNEL TANK



31

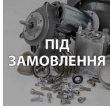

11033588

FUNNEL TANK PHEDRAEVO
FUNNEL TANK PHEDRAEVO

Model Machine

MACSAE305

КАБОВИЙ АВТОМАТ OCS PHEDRA EVO 9GR 1C3 230/50 RI

MACSAE305.T.0004



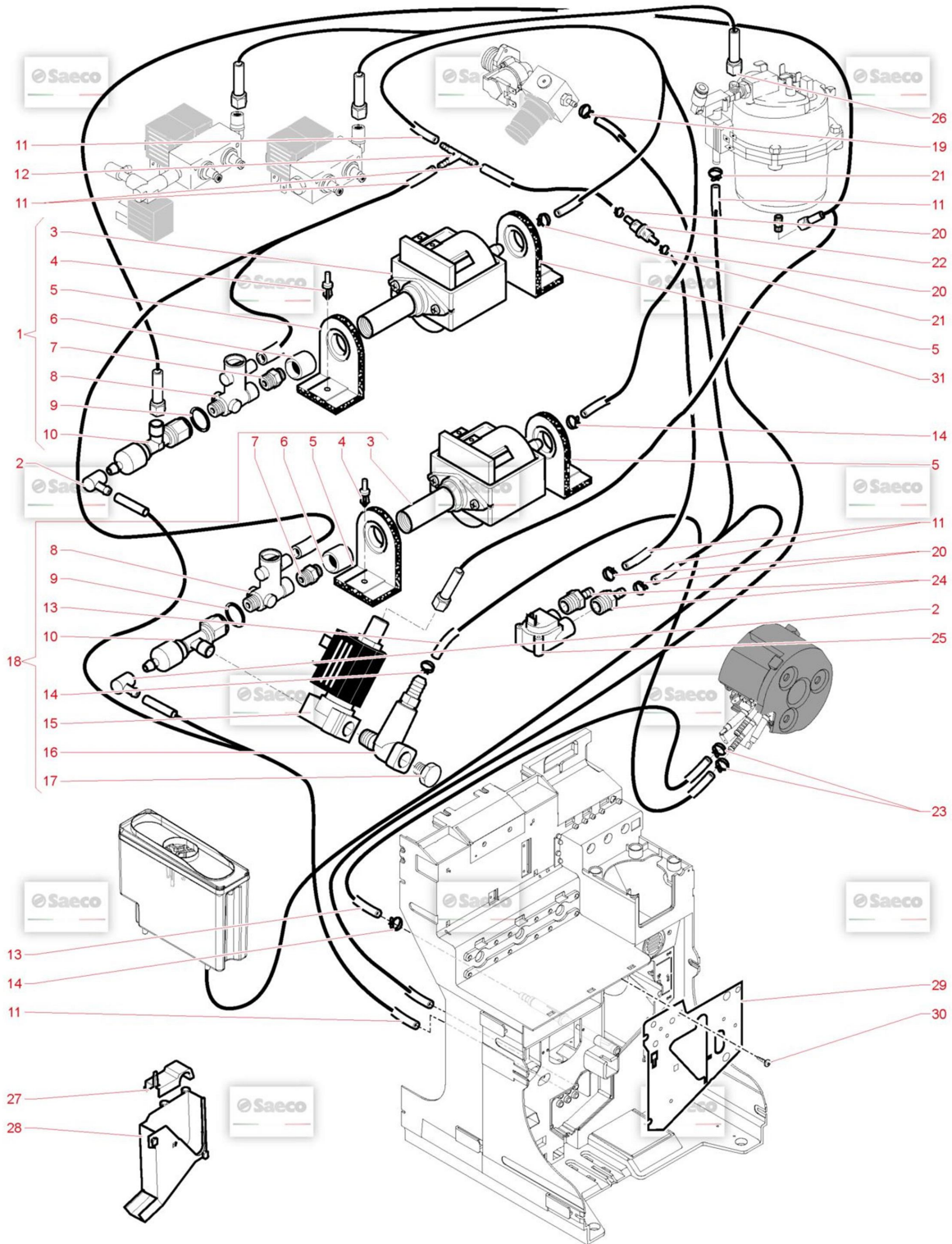









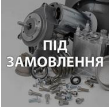

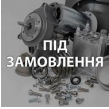

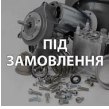

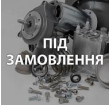

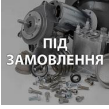

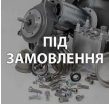

TAVOLA NR. 4 - ARTICOLO КАБОВИЙ АВТОМАТ OCS PHEDRA EVO 9GR 1C3 230/50 RI
BLK(10004854/10000068)

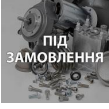

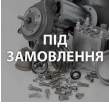
Model Machine

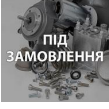
MACSAE305



























КАВОВИЙ АВТОМАТ OCS PHEDRA EVO 9GR 1C3 230/50 RI

Web	Pos.	Foto	Item - Replace by	Description
				<i>Press - CTRL + CLICK go to item in a new window Натисніть - Ctrl + права кнопка миші щоб відкрити запчастину в новому вікні</i>
	1		11034297	PUMP EX5-SD1-T3X6-220V 60HZ ASS.POMPA STD EX5-SD1-T3X6-220V 60HZ
	1		11034299	PUMP EP7 PHEDRA EVO TTT 120V ASS.POMPA EP7 PHEDRA EVO TTT 120V
	1		11034310	PUMP EX5 SD1 STDT3X6 230V PUMP EX5 SD1 STDT3X6 230V
	1		11034441	PUMP WT EX5 SD1 STDT3X6 230V PUMP WT EX5 SD1 STDT3X6 230V
	1		264047	EX5 SD1 T3X6 120V PUMP ASSEMBLY ASSIEME POMPA EX5 SD1 T3X6 120V
	2		147920150	90° INLET PUMP CONNECTOR RACCORDO A 90° IN SANTOPRENE
	3		263761	EX5KEVO/S 230V 50HZ PUMP POMPA EX5KEVO/S 230V 50HZ
	3		9070.034.00F	ULKA PUMP EP7 120V ULKA PUMP EP7 120V
	3		9070.042.00F	PUMP 120V ULKA PUMP EX5 SD1
	3		9070.042.00N	PUMP 220V ULKA PUMP EX5 SD1
	4		NF11.005	RIVET ITW D.5,5 RIVETTO ITW D 5,5
	5		149185850	ТРИМАЧ (ГУМОВИЙ)ПОМПИ ДЛЯ КАВОМАШИН SAECO MAGIC 4002012 (... SUPPORTO POMPA EATON MAGIC 4

Model Machine

MACSAE305











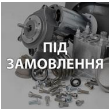

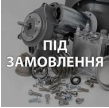

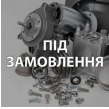







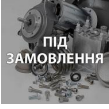

КАВОВИЙ АВТОМАТ OCS PHEDRA EVO 9GR 1C3 230/50 RI

	6		9071.098	REINFORCEMENT FOR ULKA PUMP <i>REINFORCEMENT FOR ULKA PUMP</i>
	7		11032615	FITTING ADAPTER VALVE <i>FITTING ADAPTER VALVE</i>
	8		20007360	ОБХІДНИЙ КЛАПАН FLUID-O-TECH B7E <i>BYPASS VALVE FLUID-O-TECH B7E</i>
	9		140321961	ПРОКЛАДКА O-RING ДЛЯ КАВОМАШИНИ SAECO 2031 TERMOIL <i>OR 2031 IN TERMOIL</i>
	10		11005590	SAFETY VALVE/NON RETURN ASS. NEW <i>ASS. VALVOLA SICUREZZA/NON RI</i>
	11		9972.246	СИЛІКОНОВА ТРУБКА 5X10 SAECO 265918 (2 МЕТРИ) <i>TUBO SILICONE 5X10 L.2000 MM</i>
	12		NV99.004	CONNECTOR T MORONI 8026047 D=8 <i>CONNECTOR T MORONI 8026047 D=8</i>
	13		9972.202	SILICONE TUBE 5X10 L.320MM <i>SILICONE TUBE 5X10 L.320MM</i>
	14		NV99.087	BAND D=11/11,6 <i>BAND D=11/11,6</i>
	15		11032651	ЕЛЕКТРОМАГНІТНИЙ КЛАПАН З ХОДОВИЙ N.C.2F/1M 1/8 18BAR D .1,1-1,7 <i>EV 3 VIE N.C.2F/1M 1/8"18BAR D.1,1-1,7</i>
	16		11008017	SAFETY VALVE 3,5 -4 BAR <i>SAFETY VALVE ASS. 3,5 -4 BAR</i>
	17		12001169	ЛАТУННА ЗАГЛУШКА BRASS CAP 1/8 GAS CONICAL TEA <i>BRASS CAP 1/8 GAS CONICAL TEA</i>
	18		11034295	PUMP EP7 PHEDRAEVO TTT CAPP. 230V <i>PUMP EP7 PHEDRAEVO TTT CAPP. 230V</i>

Model Machine

MACSAE305

КАВОВИЙ АВТОМАТ OCS PHEDRA EVO 9GR 1C3 230/50 RI

	18		11034298	PUMP EP7 PHEDRAEVO TTT CAPP.120V <i>ASS.POMPA EP7 PHEDRAEVO TTT CAPP.120V</i>
	18		11034300	PUMP EX5 SD1 CAPP.T3X6 230V <i>PUMP EX5 SD1 CAPP.T3X6 230V</i>
	18		11034440	CAPPUCCINO PUMP WT EX5 SD1 T3X6 230V <i>CAPPUCCINO PUMP WT EX5 SD1 T3X6 230V</i>
	19		184320200	SPRING HOSE CLAMP D=9,5MM <i>MOLLA STRINGITUBO D=9,5MM</i>
	20		NV99.072	HOSE CLAMP D. 11.6/12.3 <i>HOSE CLAMP D. 11.6/12.3</i>
	21		NV99.077	ЗАЖИМНА СТЯЖКА D=9,8/10,6 1.6 PHILIPS SAECO 996530069882 <i>FASCETTA STRINGITUBO D=9,8/10,6</i>
	22		11032038	FILTER INTAKE IN LUNG WATER SUPPLY <i>FILTRO POLMONE IN ASPIRAZ.RETE IDRICA</i>
	23		NV99.036	HOSECLAMP D=8,5 09993.41.00 <i>HOSECLAMP D=8,5 09993.41.00</i>
	24		11009215	RUBBER HOLDER FOR FILTER <i>PORTAGOMMA RESCA STANDARD 1/4 RUBBER HOLDER FOR FILTER</i>
	25		NV99.033	ПЛАСТИКОВА ТУРБИНА ВИСОКОГО ТИСКУ <i>TURBINA DIGMESA IN PLASTICA</i>
	26		11025301	TEFLON TUBE 3X6 L.220 1/8"-1/8" <i>TEFLON TUBE 3X6 L.220 1/8-1/8</i>
	27		9161.262.060	DRIP CHANNEL COVER <i>COPERTURA CANALINO RACCOGLIGOCCE</i>
	28		9111.597.050	COFFEE DISCHARGE CHANNEL SHORT <i>CANALINO SCARICO CAFFE' CORTO</i>

Model Machine

MACSAE305

КАБОВИЙ АВТОМАТ OCS PHEDRA EVO 9GR 1C3 230/50 RI



29



11013925

DRIP CANAL PLATE PHEDRA V2

DRIP CANAL PLATE PHEDRA V2



30

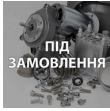

U142.008

PANELVIT TSP 3,5X12 DIN 7505 AGAL

PANELVIT TSP 3,5X12 DIN 7505 A GAL



31



11025295

TEFLON TUBE 3X6 L.170 1/8"-1/8

TEFLON TUBE 3X6 L.170 1/8-1/8

Model Machine

MACSAE305

КАВОВИЙ АВТОМАТ OCS PHEDRA EVO 9GR 1C3 230/50 RI

MACSAE305.T.0005

TAVOLA NR. 5 - ARTICOLO КАВОВИЙ АВТОМАТ OCS PHEDRA EVO 9GR 1C3 230/50 RI
BLK(10004854/10000068)

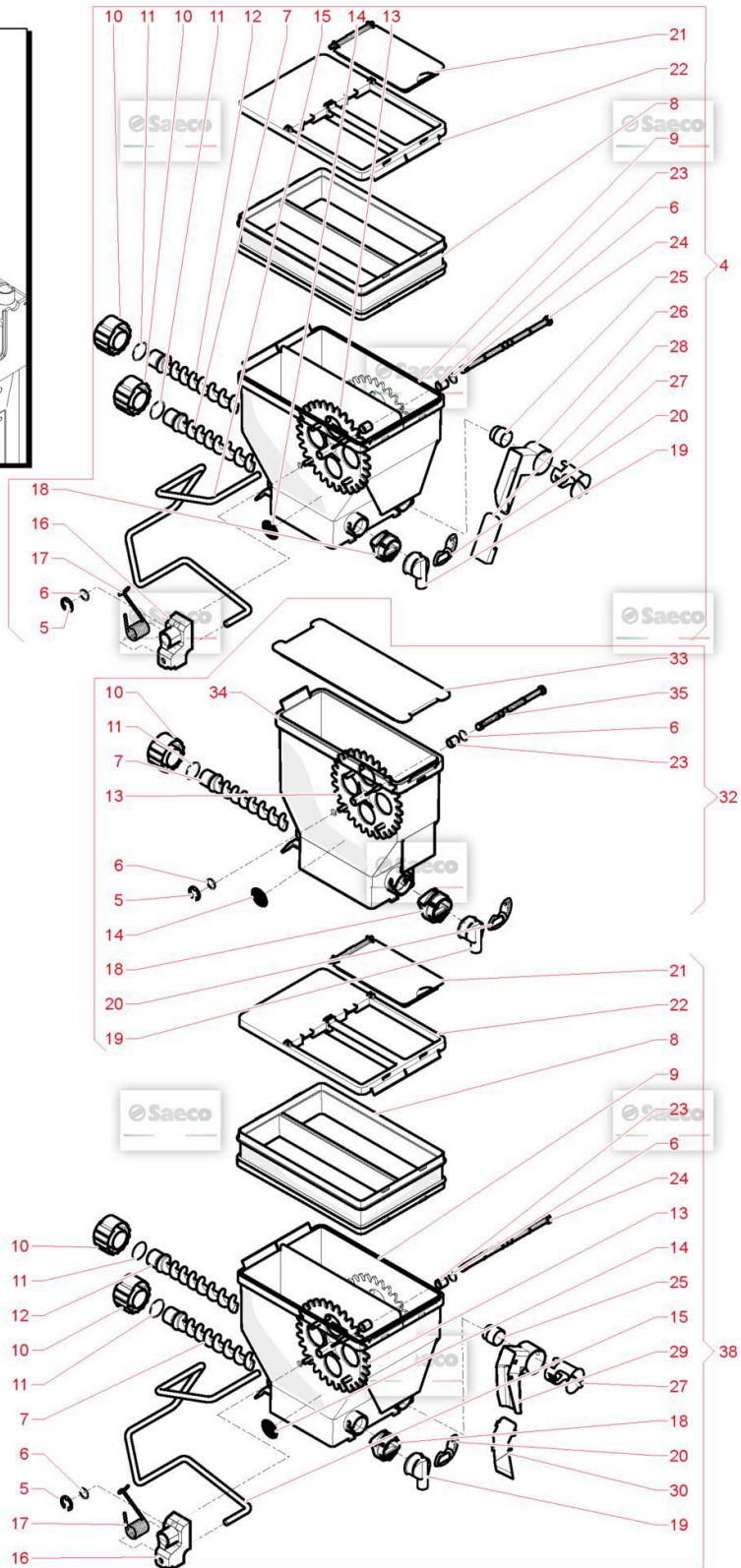
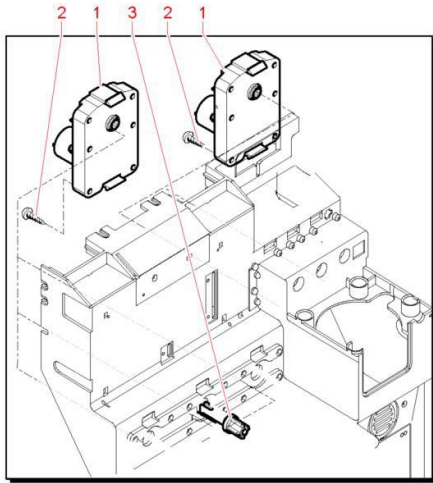

Model Machine

MACSAE305

КАВОВИЙ АВТОМАТ OCS PHEDRA EVO 9GR 1C3 230/50 RI

Web Pos. Foto Item - Replace by Description



Press - CTRL + CLICK go to item in a new window

Натисніть - Ctrl + права кнопка миші щоб відкрити запчастину в новому вікні



1



11033287

RATIOMOTOR 80 RPM K85 24VDC

RATIOMOTOR 80 RPM K85 24VDC



2

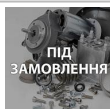

U109.002

NIK.SCREW TCB 3,5X25 DIN 7981C

NIK.SCREW TCB 3,5X25 DIN 7981 C



3



9111.586.050

PIN FOR MOTORS KENTA

PERNO X MOTORI KENTA



4

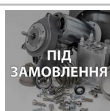

11007162

5P07 ASSEMBLED DOUBLE TANK

ASS.CONTENTITORE DOPPIO C/AGITATORE 5P07



5



U701.003

SNAP RING 7 UNI 7434

ANELLO ELASTICO 7 UNI 7434



6



NM03.022

OR ORM 0060-10 NBR

OR ORM 0060-10 NBR



7



9111.701

SCROLL SCREW DOUBLE CONTAINER

COCLEA CONTENITORE DOPPIO



8



11007016

40MM SOLUBLES CONTAINER PROLONG

40MM SOLUBLES CONTAINER PROLONG



9



9111.680

BASE CONTAINER DOUBLE SOLUBLE

BASE CONTENITORE SOLUBILI DOPPIO



10



11012130

BACK BUSH REINFORCE

BACK BUSH REINFORCE



11



NM03.013

OR 2,3X15 NBR

OR 2,3X15 NBR



12



11001658



























SCROLL SCREW

COCLEA PER DEVIATORE

Model Machine

MACSAE305



















КАВОВИЙ АВТОМАТ OCS PHEDRA EVO 9GR 1C3 230/50 RI

	13		9111.702	WHEEL DOUBLE CONTAINER <i>RUOTA CONTENITORE DOPPIO</i>
	14		9111.646	ADHESIVE FOR TANK <i>ADHESIVE FOR TANK</i>
	15		11006124	WIRE AGITATOR UNIFIED <i>FILO AGITATORE UNIFICATO WIRE AGITATOR UNIFIED</i>
	16		11007155	ПЛАСТИКОВИЙ ТРИМАЧ ВЗБИВАЛКИ SAECO 9111.735 <i>AGITATOR SUPPORT</i>
	17		9111.731	SPRING <i>MOLLA AGITATORE</i>
	18		9111.630.060	BUSH FOR POWDERS TANK <i>BOCCOLA X SERBAT.POLVERI C/AGGANCI</i>
	19		9111.629.060	APERTURE FOR SOLUBLES HOPPER <i>APERTURE FOR SOLUBLES HOPPER</i>
	20		9111.338.270	BULKHEAD FOR APERT. CLOSURE ORANGE <i>PARATIA CHIUSURA BOCCHETTA ARANCIO</i>
	21		9111.683	SOLUBLE COVER <i>COPERCHIETTO SOLUBILI</i>
	22		9111.682	COVER CONTAINER DOUBLE SOLUBLE <i>COPERCHIO CONT.SOLUBILI DOPPIO</i>
	23		11032945	SPACE FOR GEAR BPA FREE <i>SPACE FOR GEAR BPA FREE</i>
	24		9111.703	DOUBLE PIN FOR WHEEL <i>PERNO DOPPIA PER RUOTA</i>
	25		11001654	BUSH CONTAINER <i>BOCCOLA CONTENITORE</i>

Model Machine

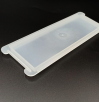
MACSAE305

КАВОВИЙ АВТОМАТ OCS PHEDRA EVO 9GR 1C3 230/50 RI

	26		9111.425.060	POWDER DUCT <i>CONDOTTO POLVERE ORIENTABILE</i>
	27		9111.457.060	BUSH FOR LEFT/RIGHT DUCT COSMEC <i>BOCCOLA X CONDOTTO DX-SX COSMEC</i>
	28		9111.428.060	PLUG FOR LEFT-RIGHT DUCT <i>TAPPO X CONDOTTO DX-SX</i>
	29		11013385	SWITCH FOR PHEDRA TTT <i>SWITCH FOR PHEDRA TTT</i>
	30		11013386	COVER FOR SWITCH PHEDRA TTT <i>COPERCHIO X DEVIATORE PHEDRA TTT</i>
	31		11034361	PHEDRA TTT ASSEMBLED DOUBLE TANK <i>PHEDRA TTT ASSEMBLED DOUBLE TANK</i>
	32		11007972	ASSEMBLY SOLUBLES CONTAINER <i>ASSEMBLY SOLUBLES CONTAINER</i>
	33		11007974	COVER CONTAINER SOLUBLE <i>COVER CONTAINER SOLUBLE</i>
	34		11001576	BASE CONTAINER SINGLE SOLUBLE <i>BASE CONTENITORE SOLUBILE SINGOLO</i>
	35		11001580	PIN WHEEL CONTAINER SINGLE SOLUBLE <i>PERNO RUOTA DENTATA CONT.SOLUB.SINGOLO</i>

Model Machine

MACSAE305

КАВОВИЙ АВТОМАТ OCS PHEDRA EVO 9GR 1C3 230/50 RI

MACSAE305.T.0006



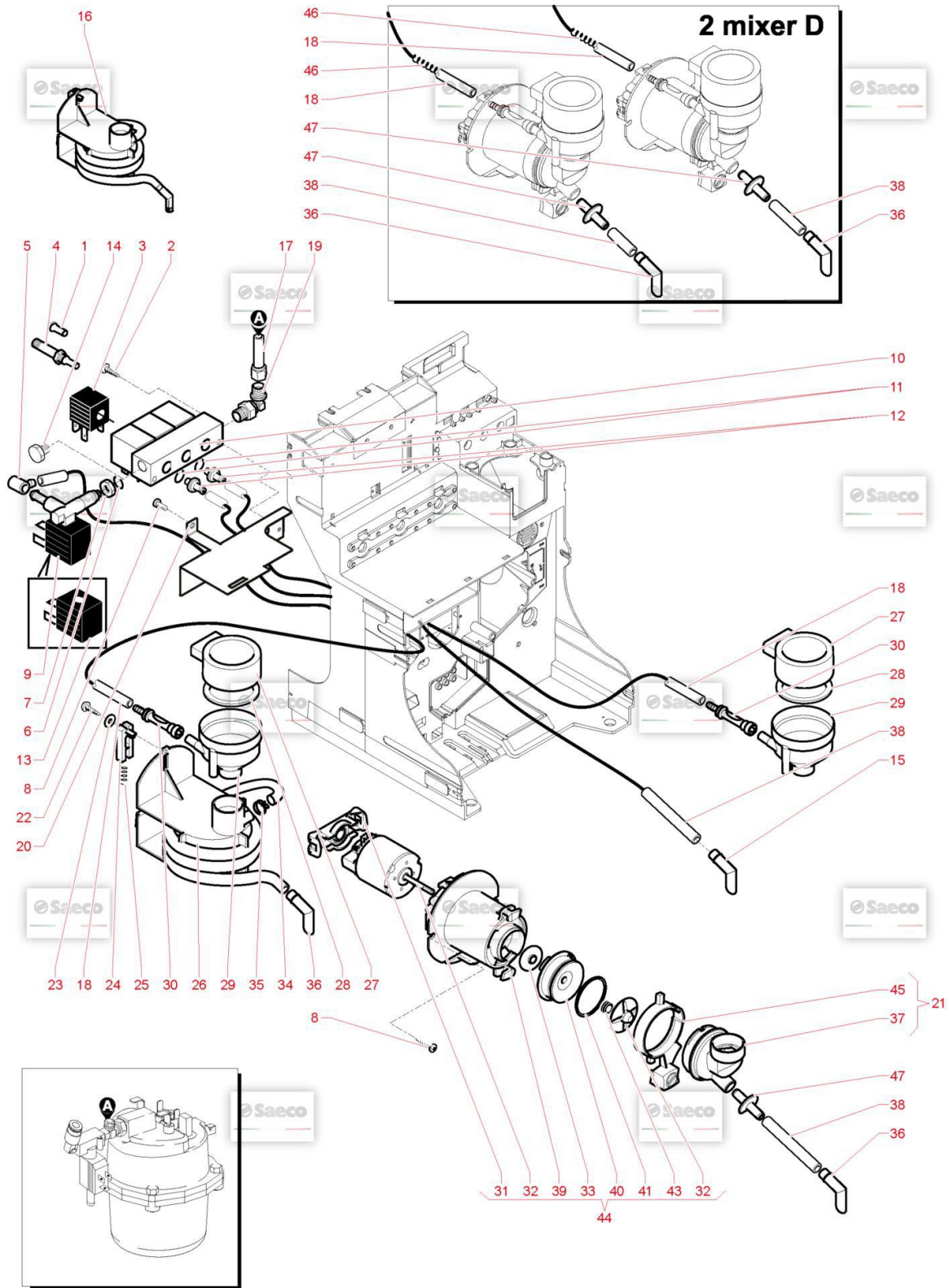





















TAVOLA NR. 6 - ARTICOLO КАВОВИЙ АВТОМАТ OCS PHEDRA EVO 9GR 1C3 230/50 RI
BLK(10004854/10000068)



Model Machine

MACSAE305























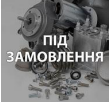

КАВОВИЙ АВТОМАТ OCS PHEDRA EVO 9GR 1C3 230/50 RI

Web	Pos.	Foto	Item - Replace by	Description
				<i>Press - CTRL + CLICK go to item in a new window Натисніть - Ctrl + права кнопка миші щоб відкрити запчастину в новому вікні</i>
	1		20007305	ЧАСТИНА ЕЛЕКТРОМАГНІТНОГО КЛАПАНА З ПОДВИЖНИМ СЕРДЕЧНИК... SPARE EV MOBILE CORE 11023762
	2		U109.021	SCREW AUT.TCB 3,5X22 DIN 7981C SCREW AUT.TCB 3,5X22 DIN 7981 C
	3		20005373	SOLENOID X HS1 11023762 SOLENOID X OLAB 24V DC 6000BH/BODN
	4		20005374	ASS.NUCLEO FIS+MOB.X 11009225 ASS.NUCLEUS 6000BH/BODN X 11009225
	5		147920150	90° INLET PUMP CONNECTOR RACCORDO A 90° IN SANTOPRENE
	6		140321462	O-RING 2018 SILICONE OR 2018 IN SILICONE
	7		9991.035	NUT 1/8 H 4.5 DADO 1/8 H.4,5
	8		U116.006	SCREW AUT.PT TCB 3,5X12 WN 1441 ZNP VITE AUT.PT TCB 3,5X12 WN 1441 ZNP
	9		11027286	ELETTROVALVE 24V DC TEA ELETTROVALVE 24V DC TEA
	10		11033567	ЕЛЕКТРОМАГНІТНИЙ БЛОК З VIE DC SAECO PHEDRA BLOCCHETTO 3 ELETTROVALVOLE DC
	11		NM01.004	OR 2025 SILICONE OR 2025 SILICONE
	12		11011453	RUBBER HOLDER CONNECTOR TEA RUBBER HOLDER CONNECTOR TEA

Model Machine

MACSAE305



























КАВОВИЙ АВТОМАТ OCS PHEDRA EVO 9GR 1C3 230/50 RI

	13	 ПІД ЗАМОВЛЕННЯ	0862.R03	COIL FOR SOLENOID VALVE 2 WAY COIL FOR SOLENOID VALVE 2 WAY
	14		12001169	ЛАТУННА ЗАГЛУШКА BRASS CAP 1/8 GAS CONICAL TEA BRASS CAP 1/8 GAS CONICAL TEA
	15		11033591	КУТОВИЙ ПЕРЕХІДНИК ВИДАЧІ КАВИ SAECO PHEDRA NOZZLE HOT WATER
	16		11008891	ASS.MIXER THE' 5P07 ASS.MIXER THE' A SPIRALE 5P07
	17		11025301	TEFLON TUBE 3X6 L.220 1/8"-1/8 TEFLON TUBE 3X6 L.220 1/8-1/8
	18	 ПІД ЗАМОВЛЕННЯ	9972.246	СИЛІКОНОВА ТРУБКА 5X10 SAECO 265918 (2 МЕТРИ) TUBO SILICONE 5X10 L.2000 MM
	19	 ПІД ЗАМОВЛЕННЯ	12001181	BICONICAL CONNECT. L M 1/8X06TEA BICONICAL CONNECT. L M 1/8X06 TEA
	20		11033393	SUPPORT SUPPORT
	21		9110.027.060	MIX CASING ASS. ASS.CORPO MIX SAECO CRISTALLO,ATLANTE,QUARZO,RUBINO
	22		U116.005	SCREW AUT.PT TCB 3,0X8 WN 1441 VITE AUT.PT TCB 3,0X8 WN 1441 ZNP
	23		U207.004	PLAIN WASHER 4,3X16 UNI 6592 GAL PLAIN WASHER 4,3X16 UNI 6592 GAL
	24		9111.209.060	CURSOR FOR SPIRAL MIXER FIXING CURSOR FOR SPIRAL MIXER FIXING
	25		9111.211	SPRING FOR MIXER CURSOR MOLLA X CURSORE MISCELATORE

Model Machine

MACSAE305

КАВОВИЙ АВТОМАТ OCS PHEDRA EVO 9GR 1C3 230/50 RI

















	26		9111.643.060	RAPID FIXING MIXER <i>RAPID FIXING MIXER</i>
	27		9111.010.060	LID FOR FUNNEL BROWN <i>COPERCHIO X IMBUTO MARRON</i>
	28		9111.011.060	SEAL FOR FUNNEL BROWN <i>GUARNIZIONE X IMBUTO MARRON</i>
	29		9111.009.060	FUNNEL FOR POWDERS BROWN <i>IMBUTO X POLVERI MARRON</i>
	30		1863.A07	ESPRESSO NOZZLE <i>ASS.UGELLO ESPRESSO</i>
	31		9111.771.270	MOTOR COUPLING ORANGE RAL <i>MOTOR COUPLING ORANGE RAL</i>
	32		9121.248.00P	MOTOP MIKCEPA '05 24V DC - M.B.T. COD. 912124800 SAECO 9121.248.00 <i>MOTORE MIXER '05 24V DC - M.B.T.</i>
	33		9111.773.060	MOTOR PROTECTION RING <i>ANELLO PROTEZIONE MOTORE MIXER '05</i>
	34		9972.055	ТРУБКА СИЛІКОНОВА 8X12 2 МЕТРИ <i>SILICONE TUBE 8X12 L.2000MM</i>
	35		NV99.072	HOSE CLAMP D. 11.6/12.3 <i>HOSE CLAMP D. 11.6/12.3</i>
	36		1813.109.050	NOZZLES <i>NOZZLES</i>
	37		9111.227.060	MIXER CASING <i>CORPO MIXER</i>
	38		9972.057	КОРИЧНЕВА ГУМОВА ТРУБКА 5X8 2 МЕТРИ <i>TUBO SILICONE MARRON 5X8 L.2000 MM</i>

Model Machine

MACSAE305

КАВОВИЙ АВТОМАТ OCS PHEDRA EVO 9GR 1C3 230/50 RI

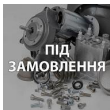
PLK/1000105/1000000

	39		9111.769.150	MIXER FLANGE <i>MIXER FLANGE</i>
	40		9111.770.060	COVER MIXER FLANGE <i>COVER MIXER FLANGE</i>
	41		NM03.012	OR ORM 0320-25 NBR <i>OR ORM 0320-25 NBR</i>
	42		9111.772.060	DISK FAN <i>VENTOLINA A DISCO MIXER '05</i>
	43		NM05.015	ПРОКЛАДКА V-RING 405 МІКСЕРА ДЛЯ КАВОМАШИН SAECO <i>V-RING MIXER '05</i>
	44		9110.160.06P	ДВИГУН МІКСЕРА ДЛЯ КАВОМАШИНИ SAECO 05 24V DC SAECO 9110.1... <i>ASS.MIXER '05 24V DC GROUP 500 SAECO</i>
	45		9111.230.270	MIXER LOCKING RING NUT ORANGERAL <i>GHIERA BLOCCAGGIO MIXER ARANCIO RAL</i>
	46		11013722	SPRING FOR TUBE L.85,5MM <i>SPRING FOR TUBE L.85,5MM</i>
	47		9111.232.060	STD TUBE HOLDER SLEEVE <i>MANICOTTO PORTATUBO STANDARD</i>

Model Machine

MACSAE305

КАВОВИЙ АВТОМАТ OCS PHEDRA EVO 9GR 1C3 230/50 RI

MACSAE305.T.0007



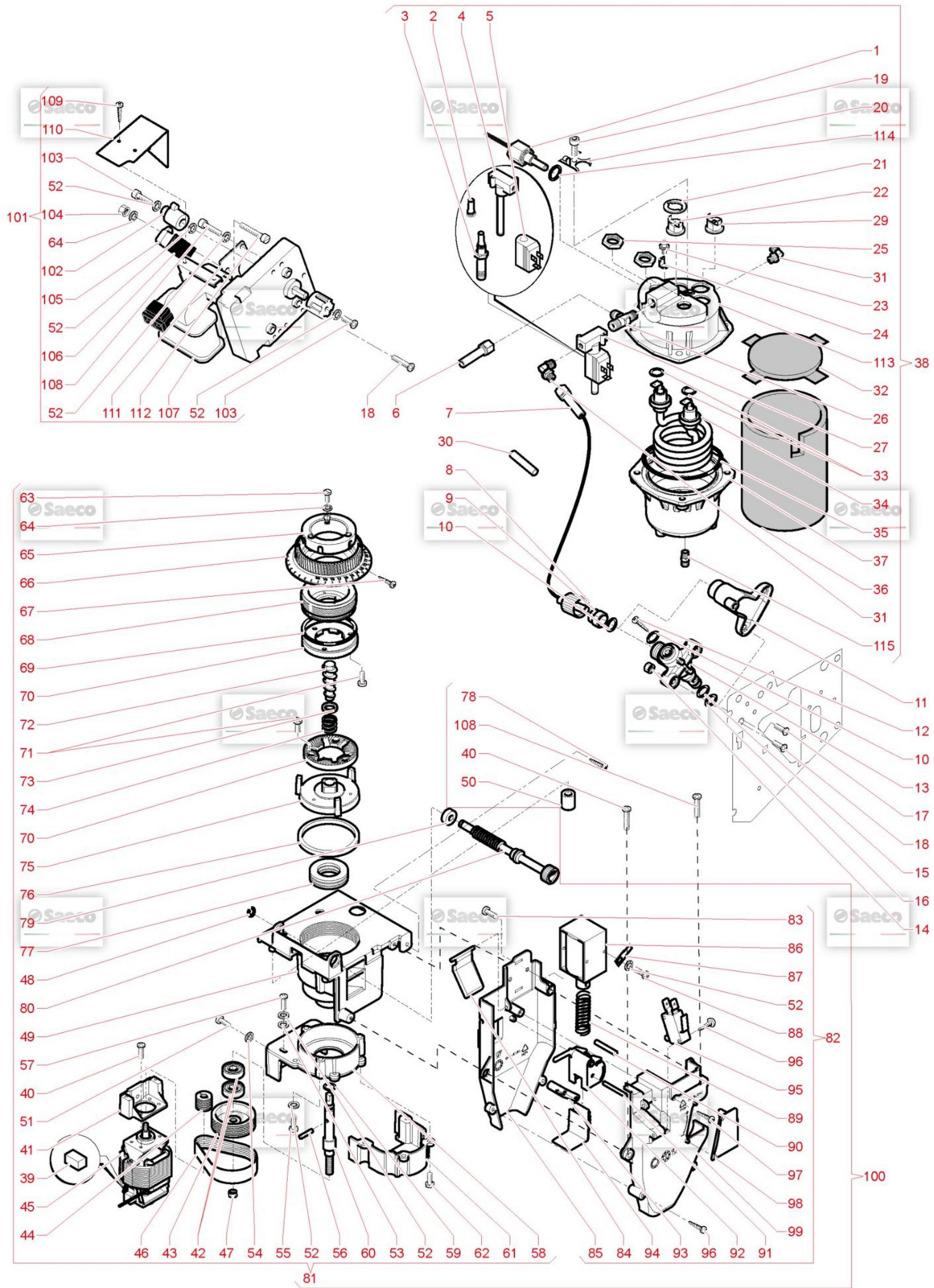













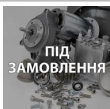

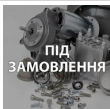





TAVOLA NR. 7 - ARTICOLO КАВОВИЙ АВТОМАТ OCS PHEDRA EVO 9GR 1C3 230/50 RI
BLK (10004854/10000068)



Model Machine

MACSAE305

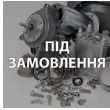

























КАВОВИЙ АВТОМАТ OCS PHEDRA EVO 9GR 1C3 230/50 RI

Web	Pos.	Foto	Item - Replace by	Description
				<i>Press - CTRL + CLICK go to item in a new window Натисніть - Ctrl + права кнопка миші щоб відкрити запчастину в новому вікні</i>
	1		11033134	ПОГРУЖНИЙ ЗОНД ТЕМПЕРАТУРИ SAECO ASS. SONDA TEMPERATURA AD IMMERSIONE
	2		20007362	SPARE CORE EV ODE RIC. NUCLEO EVT ODE
	3		20007363	SPARE EVT ODE SPARE EVT ODE
	4		20007364	SPARE EVT 11032408 SPARE EVT 11032408
	5		20007361	SOLENOID EVT ODE SOLENOID EVT ODE
	6		11025296	TEFLON TUBE 3X6 L.250 1/8"-1/8 TEFLON TUBE 3X6 L.250 1/8-1/8
	7		11025406	TUBE ASSEMBLY TEFLON 3X6 L.250MM TUBE ASSEMBLY TEFLON 3X6 L.250MM
	8		11005743	KNURLED FEMALE HAND BOLT M14 GODRONE FEMMINA M14
	9		11005741	CONNECTOR D.6 BOCCOLA ESTERNA D.6
	10		140321462	O-RING 2018 SILICONE OR 2018 IN SILICONE
	11		11013431	PHEDRA TTT SLEEVE TTT CIRCUIT PHEDRA TTT SLEEVE TTT CIRCUIT
	12		U109.037	SCREW AUT.TCB 4,8X13 DIN 7981C VITE AUT.TCB 4,8X13 DIN 7981 C NIK

Model Machine

MACSAE305



















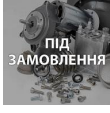

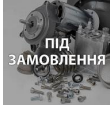

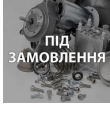

КАБОВИЙ АВТОМАТ OCS PHEDRA EVO 9GR 1C3 230/50 RI

	13		11005370	PIN FOR MUFF <i>PERNO X MANICOTTO PIN FOR MUFF</i>
	14		U302.003	МЕТАЛЕВА ГАЙКА M4 UNI 5588 ZNP <i>DADO ESAGONALE M4 UNI 5588 ZNP</i>
	15		11013173	OR ORM 0090-20 FKM 80 FD GREENPEROXIDA <i>OR ORM 0090-20 FKM 80 FD GREEN PEROXIDA</i>
	16		11013174	OR ORM 0050-20 FKM 80 FD GREENPEROXIDA <i>OR ORM 0050-20 FKM 80 FD GREEN PEROXIDA</i>
	17		U044.022	SCREW TSPC M5,0X8 UNI 7688 GALV. <i>SCREW TSPC M5,0X8 UNI 7688 GALV.</i>
	18		U044.013	SCREW TSPC M4,0X12 UNI 7688 GALV. <i>VITE TSPC M4,0X12 UNI 7688 ZNP</i>
	19		12001052	SCREW TCEI M4,0X6 DIN 912 ZIN <i>SCREW TCEI M4,0X6 DIN 912 ZIN</i>
	20		226830200	RETAIN.SPRING 3 THERM. +THERMAL FUSE <i>RETAIN.SPRING 3 THERM. +THERMAL FUSE</i>
	21		9991.085	THERMOSTAT FIXING WASHER <i>RONDELLA FERMATERMOSTATI</i>
	22		NE09.021	THERMOSTAT 150°NC FASTON 90° <i>TERMOSTATO 150°NC FASTON 90°</i>
	23		U023.020	SCREW TCEI M6X20 UNI 5931 ZIN <i>VITE TCEI M6X20 UNI 5931 8.8</i>
	24		NE15.031	MALE TONGUE PLAIN 6,3 D.6,3 <i>MALE TONGUE PLAIN 6,3 D.6,3</i>
	25		9991.029	NUT FOR RESISTOR <i>DADO X RESISTENZA</i>

Model Machine

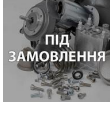
MACSAE305



















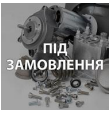

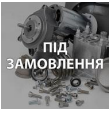

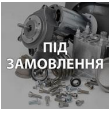

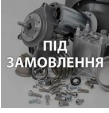
КАВОВИЙ АВТОМАТ OCS PHEDRA EVO 9GR 1C3 230/50 RI

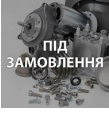
	26		11011454	"T" CONNECTOR FOR BOILER TEAT" CONNECTOR FOR BOILER TEA <i>RACCORDO A T X CALDAIA TEA</i>
	27		11032408	ЕЛЕКТРОМАГНІТНИЙ КЛАПАН 3 WAYS 24V <i>ELECTROVALVE ODE 3 WAYS 24V DC</i>
	28		11025295	TEFLON TUBE 3X6 L.170 1/8"-1/8 <i>TEFLON TUBE 3X6 L.170 1/8-1/8</i>
	28		11025301	TEFLON TUBE 3X6 L.220 1/8"-1/8 <i>TEFLON TUBE 3X6 L.220 1/8-1/8</i>
	28	 ПІД ЗАМОВЛЕННЯ	11028994	TEFLON TUBE 3X6 L.120 1/8"-1/8 <i>TEFLON TUBE 3X6 L.120 1/8"-1/8</i>
	28	 ПІД ЗАМОВЛЕННЯ	11034432	TEFLON TUBE 3X6 L.150 1/8"-1/8 <i>TEFLON TUBE 3X6 L.150 1/8"-1/8</i>
	29		189428700	THERMOSTAT 175° 1NT-15L-5126 <i>THERMOSTAT 175° 1NT-15L-5126</i>
	30		11025342	TUBE ASS.TEFLON 4X6 L.400 1/8"-1/8" <i>TUBE ASS.TEFLON 4X6 L.400 1/8-1/8</i>
	31	 ПІД ЗАМОВЛЕННЯ	12001181	BICONICAL CONNECT. L M 1/8X06TEA <i>BICONICAL CONNECT. L M 1/8X06 TEA</i>
	32		11030777	COFFEE BOILER 600CC UPPER ISOLATOR <i>COFFEE BOILER 600CC UPPER ISOLATOR</i>
	33	 ПІД ЗАМОВЛЕННЯ	11000972	OR 3050 FKM 80 FD PEROXIDICA <i>OR 3050 FKM 80 FD PEROXIDICA</i>
	34		11007591	RES CALD. V230 W1400 INC.800 <i>RESISTENZA 230V 1400W INC.800</i>
	34	 ПІД ЗАМОВЛЕННЯ	11033952	RES CALD. V230 W1400 INC.800 <i>RES.CALD. 120V 1400W INC.800</i>

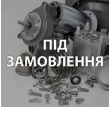
Model Machine

MACSAE305

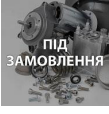













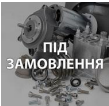

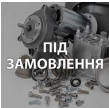







КАВОВИЙ АВТОМАТ OCS PHEDRA EVO 9GR 1C3 230/50 RI

	35		NM04.010	OR ORM 0730-40 FPM 70+-5 IRHDBLACK OR ORM 0730-40 FPM 70 +-5 IRHD NERO
	36		11030779	ІЗОЛЯЦІЯ НИЖНЬОЇ ЧАСТИНИ БОЙЛЕРА 600CC COFFEE BOILER 600CC UPPER ISOLATOR
	37		11033133	LOWER CASING BOILER 300CC TEA CORPO INFERIORE CALDAIA 300CC TEA
	38		11033301	BOILER CAPPU. PHEDRA 300CC 230V 1400W BOILER CAPPU. PHEDRA 300CC 230V 1400W
	38		11033984	BOILER PHEDRA 300CC 120V 1400W ASS.CALDAIA CAPPUCCINO 300CC 120V 1400W
	38		11034262	BOILER PHEDRA 300CC 230V 1400W BOILER PHEDRA 300CC 230V 1400W
	38		11034263	BOILER PHEDRA 300CC 120V 1400W BOILER PHEDRA 300CC 120V 1400W
	38		11034430	BOILER PHEDRA EVO WT 300CC 230V 1400W BOILER PHEDRA EVO WT 300CC 230V 1400W
	38		11034431	BOILER WT CAPPU. PHEDRA 300CC230V 1400W BOILER WT CAPPU. PHEDRA 300CC 230V 1400W
	39		20007420	MOTOR BRUSH MOTOR BRUSH
	40		12002039	SCREW TCBD TORX 20 M4X12 ZN-B VITE TCBD TORX 20 M4X12 ZN-B
	41		11027163	MOTOR SUPPORT GRINDERS D.48 MOTOR SUPPORT GRINDERS D.48
	42		11025696	BEARING RTP 608-2Z BEARING RTP 608-2Z

Model Machine

MACSAE305













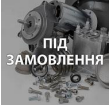

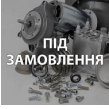



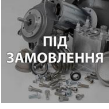



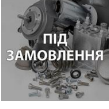

КАВОВИЙ АВТОМАТ OCS PHEDRA EVO 9GR 1C3 230/50 RI

	43		11025689	PULLEY D.40 "GRIND 48" <i>PULLEY D.40 "GRIND 48"</i>
	44		11025690	PULLEY D.15 "GRIND 48" <i>PULLEY D.15 "GRIND 48"</i>
	45		11027396	COFFEEGRINDER MOTOR D.48 230V <i>COFFEEGRINDER MOTOR D.48 230V</i>
	45		11027810	COFFEEGRINDER MOTOR D.48 120V <i>MOTORE MACINACAFFE' D.48 120V</i>
	45		262435	MOTOR КОФЕМОЛКИ D.48 230V SAECO 11027396 <i>MOTORE MACINACAFFE' D.48 230V</i>
	46		11032130	BELT GRINDER COFFEE <i>BELT GRINDER COFFEE</i>
	47		U310.004	NUT SELF LOCK.M6 UNI 7473 <i>NUT SELF LOCK.M6 UNI 7473</i>
	48		U701.011	STEEL SNAP RING 5 UNI 7434 <i>ANELLO ELASTICO 5 UNI 7434</i>
	49		11027162	GRINDERS CAP D.48 <i>GRINDERS CAP D.48</i>
	50		1813.046.050	RUBBER GRIND SUPPORT <i>RUBBER GRIND SUPPORT</i>
	51		U023.004	SCREW TCEI M6,0X12 UNI 5931 GALV. <i>VITE TCEI M6,0X12 UNI 5931 Z</i>
	52		128310404	МЕТАЛЕВЕ УБЧАСТЕ КОЛІЩАТКО UNI 8842 A4 <i>WASHER UNI 8842 A4 BURNISHED</i>
	53		U207.004	PLAIN WASHER 4,3X16 UNI 6592 GAL <i>PLAIN WASHER 4,3X16 UNI 6592 GAL</i>

Model Machine

MACSAE305



























КАВОВИЙ АВТОМАТ OCS PHEDRA EVO 9GR 1C3 230/50 RI

	54		U208.006	TOOTHED WASHER 6,4X11 UNI 3703 <i>ROSETTA DENT. 6,4X11 UNI 3</i>
	55	 ПІД ЗАМОВЛЕННЯ	12001700	SCREW TCB M4X30 UNI 7687 ZNP <i>SCREW TCB M4X30 UNI 7687 ZNP</i>
	56	 ПІД ЗАМОВЛЕННЯ	11025921	POWER PLUG UNI-EN 28743 D.3X14 <i>POWER PLUG UNI-EN 28743 D.3X14</i>
	57		12002052	ZN-B TCB SCREW M4X16 <i>ZN-B TCB SCREW M4X16</i>
	58	 ПІД ЗАМОВЛЕННЯ	11027164	MOTOR SUPPORT GRINDERS D.48 <i>MOTOR SUPPORT GRINDERS D.48</i>
	59		140321662	O-RING 2021 SILICONE <i>OR 2021 IN SILICONE</i>
	60		11025693	CENTRAL PIN "GRIND 48" <i>CENTRAL PIN "GRIND 48"</i>
	61		11027186	ЧАСТИНА КРИПЛЕННЯ КАВОМОЛКИ SAECO <i>SHELL CLOSURE BELT</i>
	62	 ПІД ЗАМОВЛЕННЯ	U127.010	SCREW TAPT.TCB M4,0X10 DIN 7500C <i>SCREW TAPT.TCB M4,0X10 DIN 7500C</i>
	63		U043.023	SCREW TCBC M3,0X18 UNI 7687 GALV. <i>VITE TCBC M3,0X18 UNI 7687 ZNP</i>
	64		U208.002	TOOTHED WASHER 3,3X5,8 UNI 3703 G <i>ROSETTA DENT. 3,3X5,8 UNI 3703 ZNP</i>
	65		11032110	BUSH <i>BUSH</i>
	66		11032640	КІЛЬЦЕ ПОМОЛУ ЗА ATL700 TTT Д.48 <i>ASS.GHIERA BLOCCATA X ATL700 TTT D.48</i>

Model Machine

MACSAE305















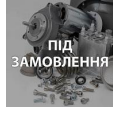

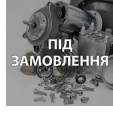

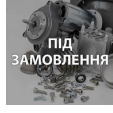



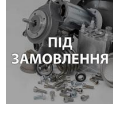

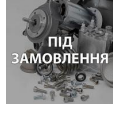
КАВОВИЙ АВТОМАТ OCS PHEDRA EVO 9GR 1C3 230/50 RI

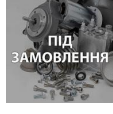
	66		1813.103.A20	RING NUT OF GRIND REGULATION <i>RING NUT OF GRIND REGULATION</i>
	67		U109.004	SCREW AUT.TCB 4,8X9,5 DIN 7981C <i>VITE AUT.TCB 4,8X9,5 DIN 798</i>
	68		11025692	UPPER GRINDING DISK HOLDER "GRIND 48" <i>UPPER GRINDING DISK HOLDER "GRIND 48"</i>
	69		12001617	OR 3206 NBR <i>OR 3206 NBR</i>
	70		11021838	НИЖ КАВОМОЛКИ SAECO D-48 (1ШТ.) <i>FLAT MILL D.47 TEA</i>
	71		U043.007	SCREW TCBC M3,0X8 UNI 7687 GALV. <i>SCREW TCBC M3,0X8 UNI 7687 GALV.</i>
	72		11025695	ШНЕК БОЛТИК ЗБІЛЬШЕННЯ "MACINE 48" <i>INCREASE SCREW "GRIND 48"</i>
	73		11027418	SPACER FOR SCREW OF INCREASE <i>SPACER FOR SCREW OF INCREASE</i>
	74		11025694	SPRING "GRIND 48" <i>SPRING GRIND 48</i>
	75		11025691	ТРИМАЧ НИЖНЬОГО НОЖА Д.48 <i>LOWER GRINDING DISK HOLDER GRIND 48</i>
	76		11027451	ПРОКЛАДКА DE=47,4 DI=41,4H=4 IN F <i>ПРОКЛАДКА DE=47,4 DI=41,4H=4 IN F</i>
	77		11025699	BEARING RTP 51104 <i>BEARING RTP 51104</i>
	78		U116.006	SCREW AUT.PT TCB 3,5X12 WN 1441 ZNP <i>VITE AUT.PT TCB 3,5X12 WN 1441 ZNP</i>

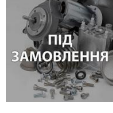
Model Machine

MACSAE305

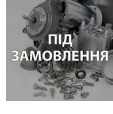











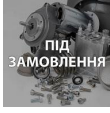











КАВОВИЙ АВТОМАТ OCS PHEDRA EVO 9GR 1C3 230/50 RI

	79		1813.159	ANTIVIBRATION RUBBER <i>ANTIVIBRATION RUBBER</i>
	80		1813.104.A20	ADJUSTMENT SCREW WITH TUBE HOLDER <i>VITE REGOLAZIONE MACININO</i>
	81		11027396	COFFEEGRINDER MOTOR D.48 230V <i>COFFEEGRINDER MOTOR D.48 230V</i>
	81		11029193	COFFEE GRINDER D.48 120V 60HZ <i>ASS.MACINACAFFE' D.48 TTT 120V60HZ</i>
	81		11031412	COFFEE GRINDER D.48 TTT <i>COFFEE GRINDER D.48 TTT</i>
	81		262434	COFFEE GRINDER ASS. <i>ASS. MACINACAFFE</i>
	82		11034032	DOSER ASS. 6-11 GR.120V UL <i>ASS.DOSATORE 6-11 GR. 120V UL NEW</i>
	82		1813.A10.A2A	DOSER ASS. 6-11 GR. <i>ASS.DOSATORE 6-11 GR.</i>
	82		262436	6-11 DOSER ASS. <i>ASS. DOSATORE 6-11</i>
	83		12002151	TSP SCREW M3X4 UNI 7688 SS <i>TSP SCREW M3X4 UNI 7688 SS</i>
	84		1813.042.A20	DISPENSER PALLET <i>DISPENSER PALLET</i>
	85		11033266	DISPENSER SHELL <i>GUSCIO INTERNO DOSATORE</i>
	86		262463	DOSER ELECTRO-MAGNET <i>ELETTROMAGNETE PER DOSATORE</i>

Model Machine

MACSAE305

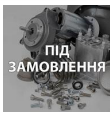

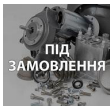



















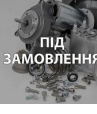

КАБОВИЙ АВТОМАТ OCS PHEDRA EVO 9GR 1C3 230/50 RI

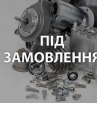
	86		9121.235.00A	ELECTROMAGNET FOR DISPENSER WITH NUCLEUS <i>ELETTROM. PER DOSATORE CON NUCLEO</i>
	86		9121.235.00F	ELECTROMAGNET X DISPENSER W/NUCLEUS 120V <i>ELECTROMAGNET X DISPENSER W/NUCLEUS 120V</i>
	87		NE15.003	MALE TONGUE PLAIN 6,3 D.5,2 <i>LINGUETTA MASCHIO PIANA 6,3 D.5,2</i>
	88		129821402	TCB SCREW M3X4 UNI 7687 ZNP <i>TCB SCREW M3X4 UNI 7687 ZNP</i>
	89		1813.127	SPRING FOR ELECTROMAGNET <i>MOLLA X ELETTROMAGNETE DOSAT</i>
	90		1813.092	PIN <i>PIN</i>
	91		1813.091	PIN FOR DISPENSER REGULATION <i>PIN FOR DISPENSER REGULATION</i>
	92		1813.043.A20	DISPENSER REGULATION <i>REGOLATORE DOSATORE</i>
	93		1813.078.A20	ADJUSTMENT LEVER <i>ADJUSTMENT LEVER</i>
	94		1813.044.A20	PALLET FOR REGULATION <i>PALETTA X REGOLATORE</i>
	95		NE05.062	MICROSWITCH + WHEEL <i>MICROINTERRUTTORE C/ROTELLA</i>
	96		U116.004	SCREW AUT.PT TCB 3,0X16 WN 1441 <i>SCREW AUT.PT TCB 3,0X16 WN 1441</i>
	97		12000390	SCREW AUT.TCB 2,9X25 DIN 7981C NIK <i>SCREW AUT.TCB 2,9X25 DIN 7981 C NIK</i>

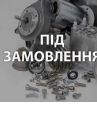
Model Machine

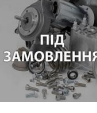
MACSAE305

























КАВОВИЙ АВТОМАТ OCS PHEDRA EVO 9GR 1C3 230/50 RI

	98		1813.191.A20	DISPENSER COVER <i>COPERTURA DOSATORE</i>
	99		11033265	OUTSIDE SHELL DISPENSER <i>GUSCIO ESTERNO DOSATORE</i>
	10001		11027395	COFFEE GRINDER D.48 + DISPENSER <i>COFFEE GRINDER D.48 + DISPENSER</i>
	10001		11031411	COFFEE GRINDER D.48 + DISPENSER <i>COFFEE GRINDER D.48 + DISPENSER</i>
	10001		11035046	COFFEE GRINDER D.48+DISPENSER120V CRS <i>ASS.MACINACAFFE' D.48+DOSAT.120V CRS EVO</i>
	10001		11035755	COFFEE GRINDER D.48 + DISPENSER EVO <i>ASS.MACINA D.48 TTT+DOSAT.120VEVO</i>
	10001		264048	GRINDER ASSEMBLY D.48 + DOSER <i>ASSIEME MACINACAF. D.48+DOSAT.</i>
	1010		11008960	RATIOMOTOR 230V 5P07 <i>ASS.MOTORIDUTTORE 230V 5P07 RATIOMOTOR 230V 5P07</i>
	1010		11023412	RATIOMOTOR PHEDRA TTT 120V CSA <i>RATIOMOTOR PHEDRA TTT 120V CSA</i>
	1010		11027117	RATIOMOTOR PHEDRA TTT 230V <i>RATIOMOTOR PHEDRA TTT 230V</i>
	1010		264049	120V GEAR MOTOR ASSEMBLY <i>ASSIEME MOTORIDUTTORE 120V</i>
	1020		11003525	CAM COFFEE GROUP FRESH BREW <i>CAM COFFEE GROUP FRESH BREW</i>
	1020		9991.037	CAM FOR RATIOMOTOR 1 MICRO <i>CAMMA X MOTORIDUTTORE 1 MICRO</i>

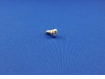
Model Machine

MACSAE305









КАВОВИЙ АВТОМАТ OCS PHEDRA EVO 9GR 1C3 230/50 RI

	1030		129824002	TCB SCREW M4X10 UNI 7687 ZNP <i>VITE TCB M4X10 UNI 7687 ZNP</i>
	1040		U302.002	NUT HEXAGONAL M3 UNI 5588 <i>NUT HEXAGONAL M3 UNI 5588</i>
	1050		NE05.066	MICROSWITCH CHERRY D419Q1A <i>МІКРОПЕРЕМИКАЧ РЕДУКТОРА РОБОЧОЇ ГРУПИ</i>
	1060		9991.014	CARD FOR MICRO SWITCHES <i>CARTONCINO X MICROINTERRUPTORE</i>
	1070		11032817	RATIOMOTOR 30 PACK 230/240-50 <i>RATIOMOTOR 30 PACK 230/240-50</i>
	1070		11032818	RATIOMOTOR 30 PACK 120/60 <i>RATIOMOTOR 30 PACK 120/60</i>
	1070		11035557	RATIOMOTOR 30 PLAST.P.F. 230/240-50 <i>MOTORID. PACCO 30 PLAST.P.F. 230/240-50</i>
	1070		11035558	RATIOMOTOR 30 PACK 120/60 <i>MOTORIDUTT.IN PLASTICA PACCO 30 120/60</i>
	1080		129825502	TCB SCREW M4X25 UNI 7687 ZNP <i>TCB SCREW M4X25 UNI 7687 ZNP</i>
	1090		129511903	SCREW TCB 2,9X6,4 DIN 7981 BZNICK <i>SCREW TCB 2,9X6,4 DIN 7981 BZ NICK</i>
	1100		11014251	CENTRAL UNIT MOTOR STEEL CARTER <i>CENTRAL UNIT MOTOR STEEL CARTER</i>
	1110		11003524	PLATE FOR MICRO RATIOMOTOR <i>PLATE FOR MICRO RATIOMOTOR</i>
	1110		9991.015	PLATE FOR MICRO <i>PIASTRINA X MICRO</i>

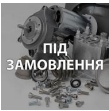
Model Machine

MACSAE305

КАБОВИЙ АВТОМАТ OCS PHEDRA EVO 9GR 1C3 230/50 RI

	1120		U034.001	SCREW TCI M3,0X30 UNI 6107 GALV. VITE TCI M3,0X30 UNI 6107 ZNP
	1120		U034.003	SCREW TCI M3,0X20 UNI 6107 GALV. SCREW TCI M3,0X20 UNI 6107 GALV.
	1130		11033131	UPPER CASING BOILER 300CC TEA CORPO SURIORE CALDAIA 300CC TEA NUOVO PREZZO 32.64
	1140		11033220	OR ORM 2043 FKM 80 FD GREEN PEROXIDA OR ORM 2043 FKM 80 FD GREEN PEROXIDA
	1150		9991.059	STRAIGHT BICONE CONNECTOR M 1/8X06 STRAIGHT BICONE CONNECTOR M 1/8X06

Model Machine

MACSAE305

КАБОВИЙ АВТОМАТ OCS PHEDRA EVO 9GR 1C3 230/50 RI

MACSAE305.T.0008

TAVOLA NR. 8 - ARTICOLO КАБОВИЙ АВТОМАТ OCS PHEDRA EVO 9GR 1C3 230/50 RI
BLK(10004854/10000068)

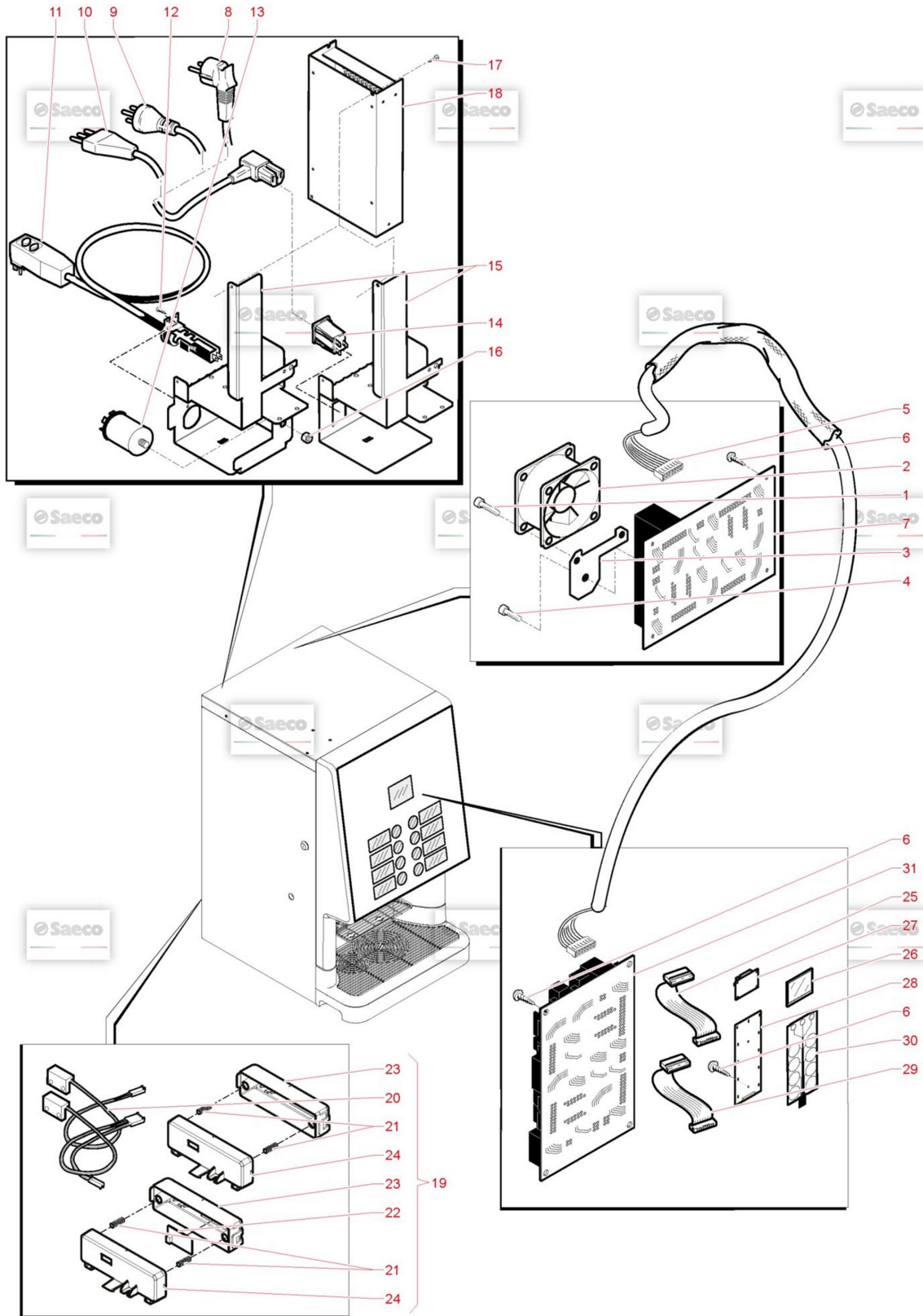

Model Machine

MACSAE305

КАВОВИЙ АВТОМАТ OCS PHEDRA EVO 9GR 1C3 230/50 RI

Web Pos. Foto Item - Replace by Description



Press - CTRL + CLICK go to item in a new window
Натисніть - Ctrl + права кнопка миші щоб відкрити запчастину в новому вікні



1



U143.022

SCREW T.M.T. K.F.R. 3,5X9,5 ZNP
 VITE T.M.T. K.F.R. 3,5X9,5 ZNP



2



11025054

FAN 40X40X20 24V
 FAN 40X40X20 24V



2

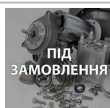

11034389

HARNESS CONNECTIONS SENSORS W/TANK
 CABLAGGIO COLLEGAMENTI SENSORIC/SERB.



3

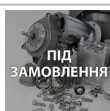

11024107

PHEDRA MAINBOARD COOLING FAN SUPP.PLATE
 PHEDRA MAINBOARD COOLING FAN SUPP.PLATE



4



129511803

SCREW TCB 2,9X6,4 DIN 7981 NICK
 SCREW TCB 2,9X6,4 DIN 7981 NICK



5



11033720

POWER SUPPLY HARNESS PW PORT PT
 POWER SUPPLY HARNESS PW PORT PT



5

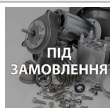

11033995

POWER SUPPLY HARNESS PW PORT PT 120V
 CABLAGGIO ALIMENTAZIONE PW PORTA BT 120V



6



U116.006

SCREW AUT.PT TCB 3,5X12 WN 1441 ZNP
 VITE AUT.PT TCB 3,5X12 WN 1441 ZNP



7

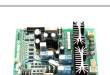

11033318

СИЛОВА ПЛАТА SAECO PHEDRA EVO
 POWER PHEDRA EVO



8



NE01.050

CABLE SCHUKO WITH PLUG EN60320C1
 CAVO SCHUKO CON SPINA EN60320 C13



9



NE01.053

CABLE AUSTRAL. +PLUG EN60320 C13
 CABLE AUSTRAL. +PLUG EN60320 C13



9

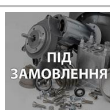











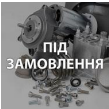

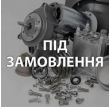

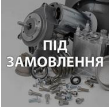



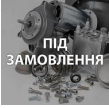



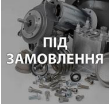

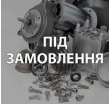
NE01.093

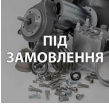
CABLE ARGENTINA + PLUG EN60320C13
 CABLE ARGENTINA + PLUG EN60320 C13

Model Machine

MACSAE305

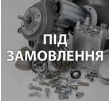









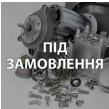

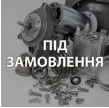











КАБОВИЙ АВТОМАТ OCS PHEDRA EVO 9GR 1C3 230/50 RI

	10		17800019	BLACK POWER CABLE BRAZIL L=1200 <i>BLACK POWER CABLE BRAZIL L=1200</i>
	10		NE01.051	CABLE SWITZERLAND WITH PLUG EN603 <i>CABLE SWITZERLAND WITH PLUG EN603</i>
	11		11012009	POWER CABLE USA 3 POLE 15A X GFC8 <i>POWER CABLE USA 3 POLE 15A X GFC8</i>
	12		U110.005	SCREW AUT.TCB 3,9X9,5 DIN 7981F <i>VITE AUT.TCB 3,9X9,5 DIN 798</i>
	13		184651500	LOCKING SCREW ANTIDISTURB FILTER 16A <i>LOCKING SCREW ANTIDISTURB FILTER 16A</i>
	14		187850400	TRIPOLE SOCKET SELF-LOCKING <i>TRIPOLE SOCKET SELF-LOCKING</i>
	15		11033980	PLATE ELECTRONICS PARTS PHEDRAEVO 120V <i>PIASTRA PARTI ELETTR.PHEDRA EVO 120V</i>
	15		11034010	SUPPORT ELECTRICAL PARTS PHEDRA EVO <i>SUPPORT ELECTRICAL PARTS PHEDRA EVO</i>
	16		U302.007	NUT HEXAGONAL M8 UNI 5588 <i>NUT HEXAGONAL M8 UNI 5588</i>
	17		U110.004	SCREW AUT.TCB 3,5X6,5 DIN 7981F <i>VITE AUT.TCB 3,5X6,5 DIN 7981 F NIK</i>
	18		12002120	SWITCHING DELTA PMT-24V-150W-1A <i>ALIMENTATORE DELTA PMT-24V-150W-1A</i>
	19		11034303	TRAY SENSOR WATER AND GROUND <i>TRAY SENSOR WATER AND GROUND</i>
	19		11034870	TRAY SENSOR WATER AND GROUND WT <i>ASS.SENSORI CASSETTI ACQUA E FONDI WT</i>

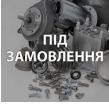
Model Machine

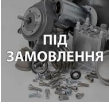
MACSAE305

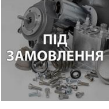
КАВОВИЙ АВТОМАТ OCS PHEDRA EVO 9GR 1C3 230/50 RI

	20		11033722	ПАРА ДАТЧИКІВ З ПРОВОДОМ ПІДКЛЮЧЕННЯ <i>HARNES CONNECTIONS SENSORS</i>
	21		12000881	COMPRESSION SPRING D.6,7 FILO0,6 L=23,5 <i>COMPRESSION SPRING D.6,7 FILO 0,6 L=23,5</i>
	22		11003232	AS.CPU+SW WATER LEVEL SENSOR V2 <i>AS.CPU+SW WATER LEVEL SENSOR V2</i>
	23		11033409	WATER LEVEL SENSOR CURSOR <i>WATER LEVEL SENSOR CURSOR</i>
	24		11033408	WATER LEVEL SENSOR SUPPORT <i>WATER LEVEL SENSOR SUPPORT</i>
	25		11033714	ШЛЕЙФ КЛАВІАТУРА-ДІСПЛЕЙ <i>HARNES INTERFACE+DISPLAY</i>
	26		11032399	3,5" TFT DISPLAY 320X240 <i>3,5 TFT DISPLAY 320X240</i>
	27		11032383	HW INTERF. NEW TFT DISPLAY UMSH-8252MD-T <i>SCHEDA INTERF. DISPLAY TFT UMS H-8252MD-T CRISTALLO400/600/PHE...</i>
	28		11033316	TASTIERA CAPACITIVA PHEDRA EVO <i>TASTIERA CAPACITIVA PHEDRA EVO</i>
	29		11033775	HARNES LED PHEDRA EVO <i>CABLAGGIO LED PHEDRA EVO</i>
	30		11033283	CAPACITIVE ADHESIVE CIRCUIT 11KEYS <i>CIRCUITO ADESIVO CAPACITIVO 11 TASTI</i>
	31		11033766	CPU+SW PHEDRA EVO <i>ASS. CPU + SW PHEDRA EVO</i>
	31		11034765	CPU+SW PHEDRA EVO NO PAYMENTS <i>CPU+SW PHEDRA EVO NO PAYMENTS</i>

Model Machine

MACSAE305

КАБОВИЙ АВТОМАТ OCS PHEDRA EVO 9GR 1C3 230/50 RI

MACSAE305.T.0009

TAVOLA NR. 9 - ARTICOLO КАБОВИЙ АВТОМАТ OCS PHEDRA EVO 9GR 1C3 230/50 RI
BLK(10004854/10000068)

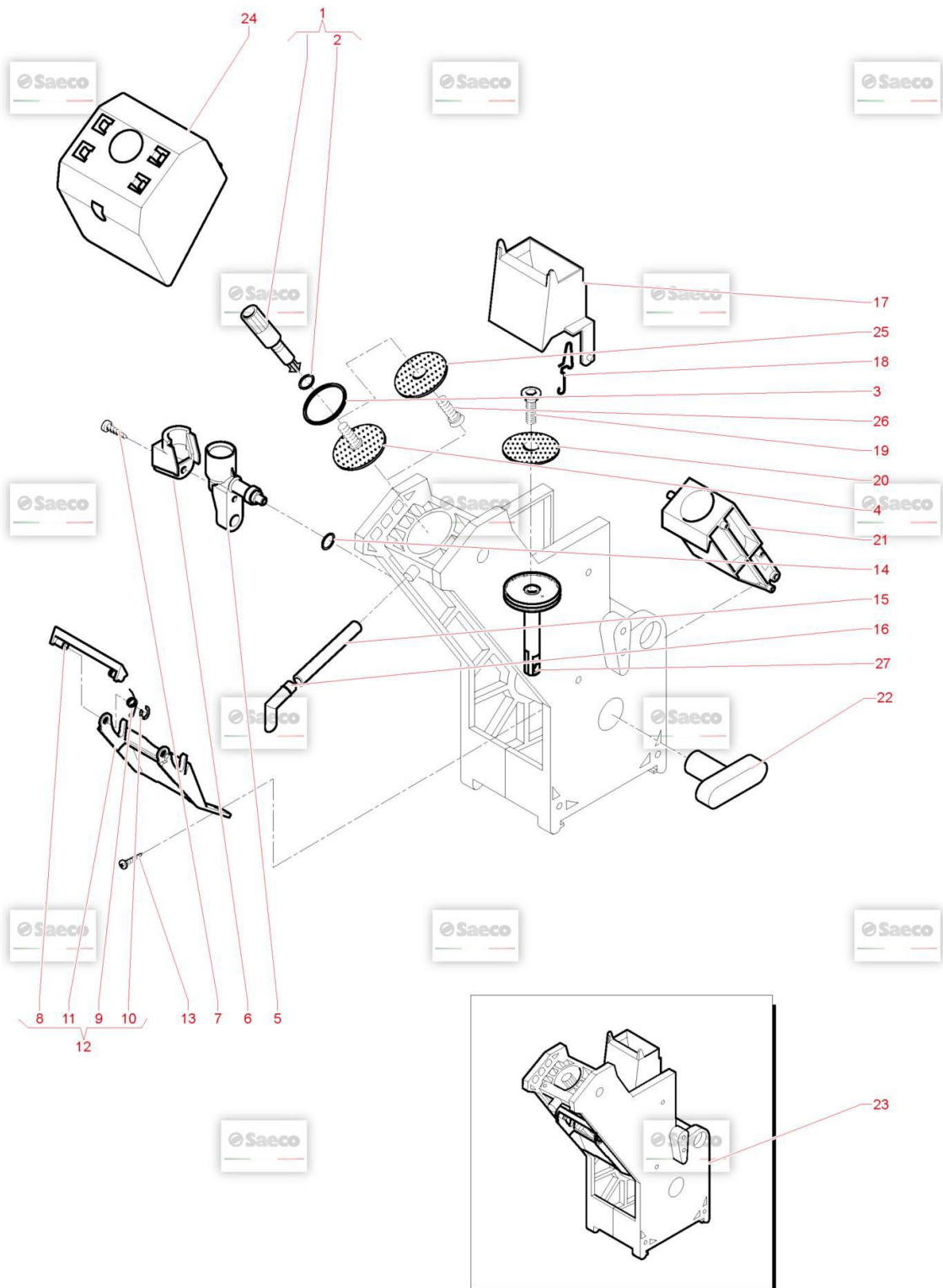

























Model Machine

MACSAE305

КАВОВИЙ АВТОМАТ OCS PHEDRA EVO 9GR 1C3 230/50 RI























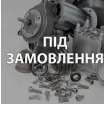

PLK/1000105/1000000

Web	Pos.	Foto	Item - Replace by	Description
				<i>Press - CTRL + CLICK go to item in a new window Натисніть - Ctrl + права кнопка миші щоб відкрити запчастину в новому вікні</i>
	1		9169.A14.060	ТРИМАЧ ФІЛЬТРА-СИТО РОБОЧОГО БЛОКУ КОРИЧНЕВИЙ КАВОМАШИН... <i>PIN FOR PERCOLATOR BROWN</i>
	2		NM02.006	OR R5 TERMOIL <i>OR R5 EPDM</i>
	3		140322061	O-RING 4112 EPDM <i>OR 4112 IN EPDM</i>
	4		324000100	SS PERCOLATOR D=34 SCREW FOR UNIT <i>SS PERCOLATOR D=34 SCREW FOR UNIT</i>
	5		11005371	UNIT COFFEE MUFF <i>MANICOTTO GRUPPO CAFFE' UNIT COFFEE MUFF</i>
	6		11010013	CARTER FOR MUFF PREHEATING UNIT <i>CARTE X MANICOTTO GRUPPO PRERISCALDO</i>
	7		129512921	SCREW TCB TORX 10 AB 2,9X13 SHEET SS <i>SCREW TCB TORX 10 2,9X13 SHEET SS</i>
	8		9111.537.060	BROWN SCRAPER COFFEE GROUP <i>BROWN SCRAPER COFFEE GROUP</i>
	9		9111.520	SPRING FOR SCRAPER SECTION 0.6 <i>SPRING FOR SCRAPER SECTION 0.6</i>
	10		U701.006	ФІКСУЮЧА СКОБА 3,2 (ЗАПІЗО) SAECO <i>ANELLO ELASTICO 3,2</i>
	11		9111.539.060	FORK FOR SCRAPER <i>FORCELLA PER RASCHIATORE</i>
	12		9110.067.060	SCRAPER ASS.FOR CAPPUCINAT. TUBE <i>ASS.RASCHIATORE X SG500/700</i>

Model Machine

MACSAE305

КАВОВИЙ АВТОМАТ OCS PHEDRA EVO 9GR 1C3 230/50 RI

	13		U110.013	БОЛТ МЕТАЛЕВИЙ 3,9X6,5 DIN 7981 F SCREW AUT.TCB 3,9X6,5 DIN 7981 F
	14		140321462	O-RING 2018 SILICONE OR 2018 IN SILICONE
	15		9972.057	КОРИЧНЕВА ГУМОВА ТРУБКА 5X8 2 МЕТРИ TUBO SILICONE MARRON 5X8 L.2000 MM
	16		1813.109.050	NOZZLES NOZZLES
	17		322001201	MOBILE SCRAPER BROWN NARROW MOBILE SCRAPER BROWN NARROW
	18		9161.425	SPRING FOR SCRAPER SPRING FOR SCRAPER
	19		129851921	TSP SCREW M3X6 UNI 7688 SS TSP SCREW M3X6 UNI 7688 SS
	20		324000200	SS PERCOLATOR D=34 FOR UNIT SS PERCOLATOR D=34 FOR UNIT
	21		222711101	BROWN GROUND COFF.CONTAINER D=36 ASSY. BROWN GROUND COFF.CONTAINER D=36 ASSY.
	22		9161.021.060	KEY FOR BREW UNIT BROWN CHIAVE X GRUPPO CAFFE' MARRO
	23		11023330	ЗАВАРОЧНИЙ БЛОК (7GR) ДЛЯ КОФЕМАШИНЫ PHILIPS SAECO BREW UNIT 7 GRAMS CRISTALLO600
	24		11013053	CARTER FOR DOSER UNIT CARTER FOR DOSER UNIT
	25		11012630	PERCOLATOR D.34 PERCOLATOR D.34

Model Machine

MACSAE305

КАБОВИЙ АВТОМАТ OCS PHEDRA EVO 9GR 1C3 230/50 RI



26



129852821

TSP SCREW M3X14 UNI 7688 SS

TSP SCREW M3X14 UNI 7688 SS



27



322001050

COFF. GROU. EXP. BLACK D=36 FOR UN

COFF. GROU. EXP. BLACK D=36 FOR UN

Model Machine

MACSAE305

КАБОВИЙ АВТОМАТ OCS PHEDRA EVO 9GR 1C3 230/50 RI

MACSAE305.T.0010



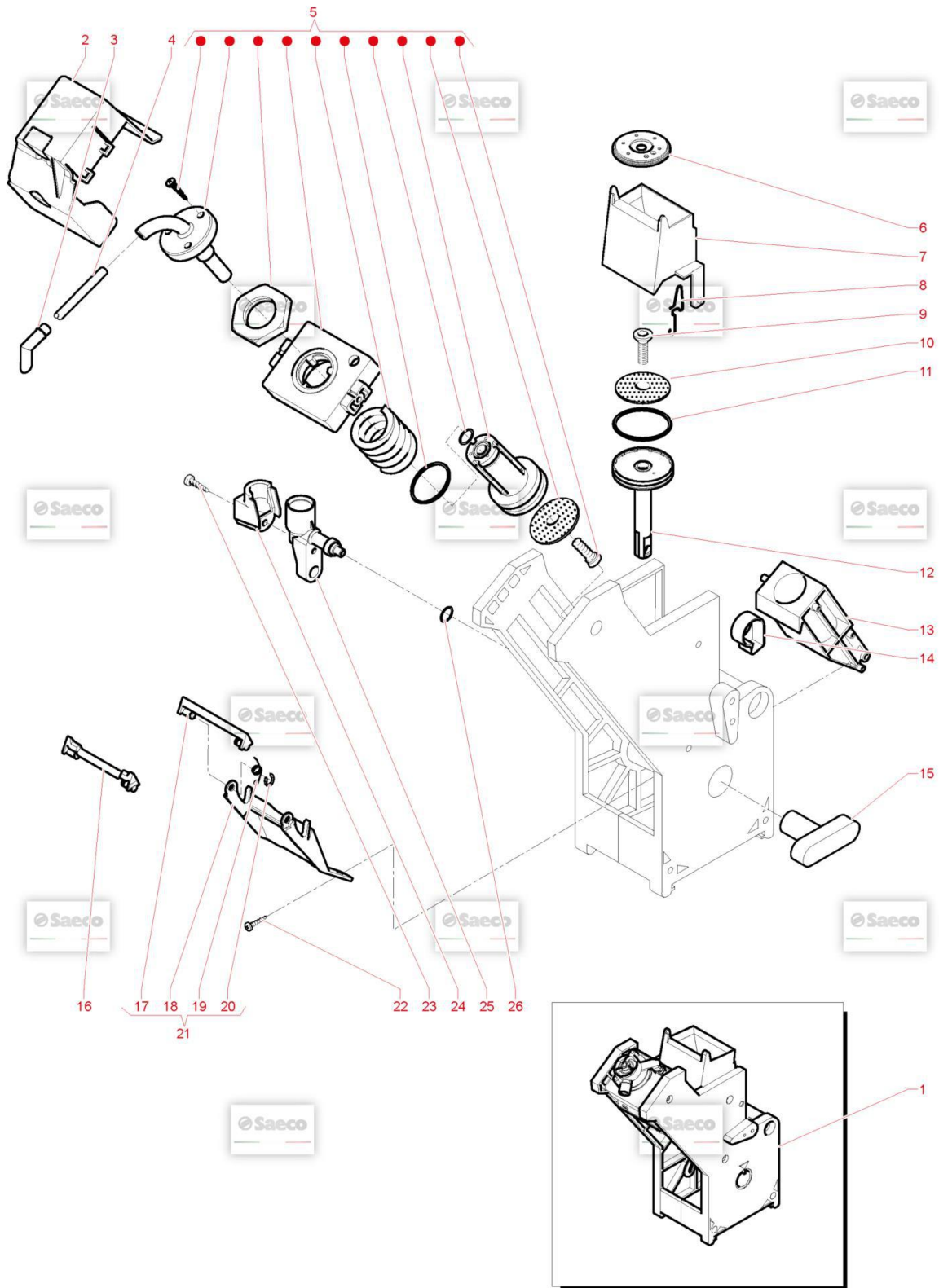









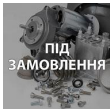





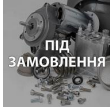

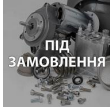

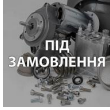

TAVOLA NR. 10 - ARTICOLO КАБОВИЙ АВТОМАТ OCS PHEDRA EVO 9GR 1C3 230/50 RI
BLK(10004854/10000068)

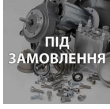

Model Machine

MACSAE305

















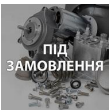







КАВОВИЙ АВТОМАТ OCS PHEDRA EVO 9GR 1C3 230/50 RI

Web	Pos.	Foto	Item - Replace by	Description
				<i>Press - CTRL + CLICK go to item in a new window Натисніть - Ctrl + права кнопка миші щоб відкрити запчастину в новому вікні</i>
	1		11031863	BREWING UNIT ASS. 7GR GUSTO COFFEE GROUP 6/8GR NEW
	2		11029737	PROTECTION VALVE PROTEZIONE VALVOLA SFIATO GRUPPO CAFFE
	3		1813.109.050	NOZZLES NOZZLES
	4		9972.285	SILICONE TUBE 3.5X6 L.220 MM SILICONE TUBE 3.5X6 L.220 MM
	5		20007811	HEAD GROUP ASS.TESTATA GRUPPO GUSTO
	6		11030122	SPACE SPACE
	7		322001201	MOBILE SCRAPER BROWN NARROW MOBILE SCRAPER BROWN NARROW
	8		9161.425	SPRING FOR SCRAPER SPRING FOR SCRAPER
	9		129851921	TSP SCREW M3X6 UNI 7688 SS TSP SCREW M3X6 UNI 7688 SS
	10		324000200	SS PERCOLATOR D=34 FOR UNIT SS PERCOLATOR D=34 FOR UNIT
	11		140322500	ПРОКЛАДКА O-RING 2118 SH70 BIANCHI 36363116-01, SAECO 140322500 OR 2118 IN NITRIL RUBBER
	12		11029879	ПОРШЕНЬ РОБОЧОГО БЛОКУ X 7 ГРАМ ASS.PISTONE X GRUPPO CAFFE'

Model Machine

MACSAE305

КАВОВИЙ АВТОМАТ OCS PHEDRA EVO 9GR 1C3 230/50 RI

	13		222711101	BROWN GROUND COFF.CONTAINER D=36 ASSY. <i>BROWN GROUND COFF.CONTAINER D=36 ASSY.</i>
	14		11030309	RING FOR CAM <i>ANELLO X CAMMA PISTONE</i>
	15		9161.021.060	KEY FOR BREW UNIT BROWN <i>CHIAVE X GRUPPO CAFFE' MARRO</i>
	16		11012957	SCRAPER FOR COFFEE UNIT 7-9GR. <i>SCRAPER FOR COFFEE UNIT 7-9GR.</i>
	17		9111.537.060	BROWN SCRAPER COFFEE GROUP <i>BROWN SCRAPER COFFEE GROUP</i>
	18		9111.539.060	FORK FOR SCRAPER <i>FORCELLA PER RASCHIATORE</i>
	19		9111.520	SPRING FOR SCRAPER SECTION 0.6 <i>SPRING FOR SCRAPER SECTION 0.6</i>
	20		U701.006	ФІКСУЮЧА СКОБА 3,2 (ЗАПІЗО) SAECO <i>ANELLO ELASTICO 3,2</i>
	21		9110.067.060	SCRAPER ASS.FOR CAPPUCCIAT. TUBE <i>ASS.RASCHIATORE X SG500/700</i>
	22		U110.013	БОЛТ МЕТАЛЕВИЙ 3,9X6,5 DIN 7981 F <i>SCREW AUT.TCB 3,9X6,5 DIN 7981 F</i>
	23		129512921	SCREW TCB TORX 10 AB 2,9X13 SHEET SS <i>SCREW TCB TORX 10 2,9X13 SHEET SS</i>
	24		11010013	CARTER FOR MUFF PREHEATING UNIT <i>CARTE X MANICOTTO GRUPPO PRERISCALDO</i>
	25		11005371	UNIT COFFEE MUFF <i>MANICOTTO GRUPPO CAFFE' UNIT COFFEE MUFF</i>

Model Machine

MACSAE305

КАБОВИЙ АВТОМАТ OCS PHEDRA EVO 9GR 1C3 230/50 RI



26



140321462

O-RING 2018 SILICONE

OR 2018 IN SILICONE

Model Machine

MACSAE305

КАБОВИЙ АВТОМАТ OCS PHEDRA EVO 9GR 1C3 230/50 RI

MACSAE305.T.0011



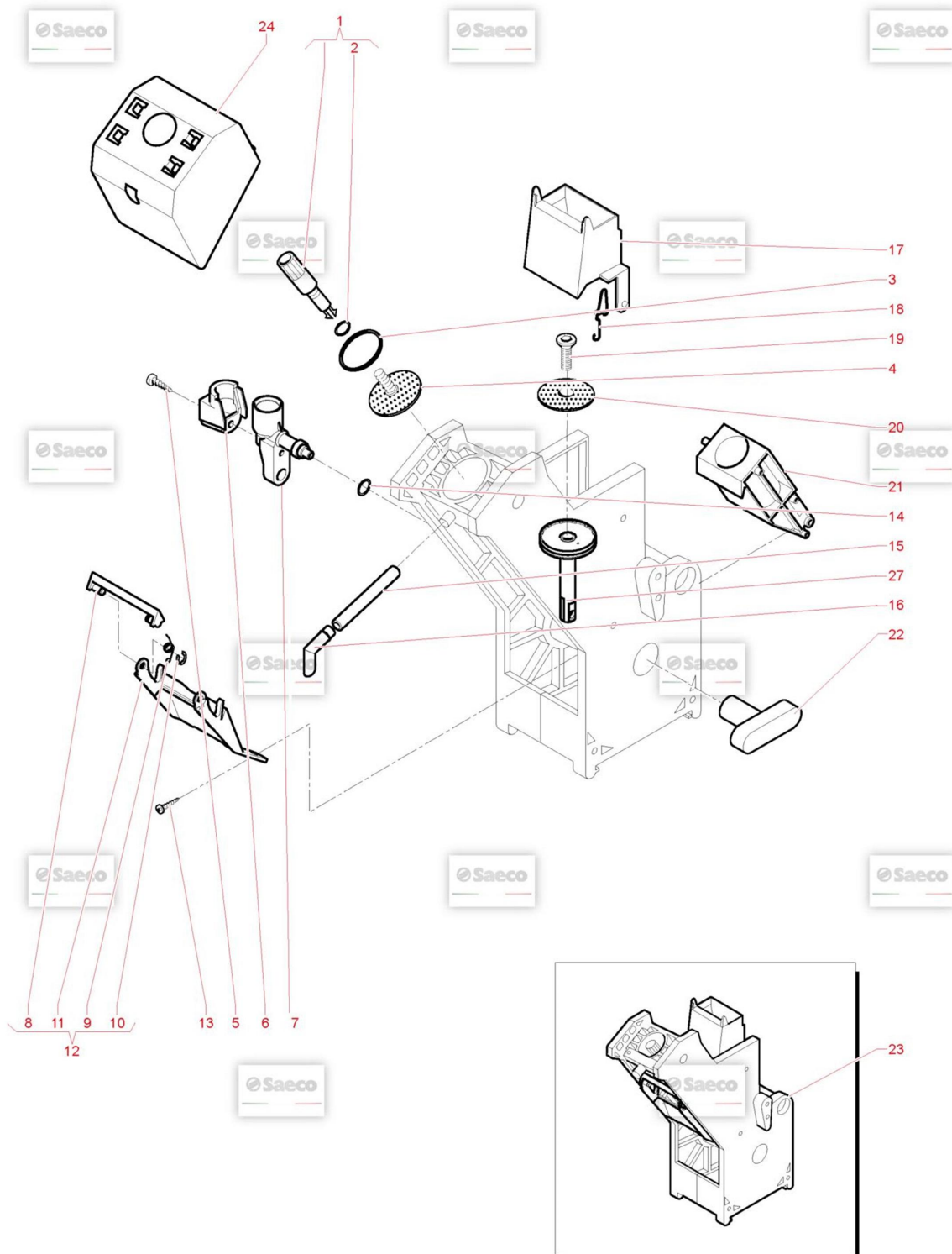





















TAVOLA NR. 11 - ARTICOLO КАБОВИЙ АВТОМАТ OCS PHEDRA EVO 9GR 1C3 230/50 RI
BLK(10004854/10000068)



Model Machine

MACSAE305



























КАВОВИЙ АВТОМАТ OCS PHEDRA EVO 9GR 1C3 230/50 RI

Web	Pos.	Foto	Item - Replace by	Description
				<i>Press - CTRL + CLICK go to item in a new window Натисніть - Ctrl + права кнопка миші щоб відкрити запчастину в новому вікні</i>
	1		9169.A14.150	PIN FOR PERCOLATOR GREY ASS.PERNO X DOCCIA COMPLETO GRIGIO
	2		NM02.006	OR R5 TERMOIL OR R5 EPDM
	3		NM01.044	OR ORM 0320-40 SILICONE PTFE/FDA OR ORM 0320-40 SILICONE PTFE
	4		9161.036	UPPER PERCOLATOR FOR UNIT DOCCIA SUPERIORE X GRUPPO
	5		129512921	SCREW TCB TORX 10 AB 2,9X13 SHEET SS SCREW TCB TORX 10 2,9X13 SHEET SS
	6		11010013	CARTER FOR MUFF PREHEATING UNIT CARTE X MANICOTTO GRUPPO PRERISCALDO
	7		11005371	UNIT COFFEE MUFF MANICOTTO GRUPPO CAFFE' UNIT COFFEE MUFF
	8		9111.537.150	GREY SCRAPER COFFEE GROUP GREY SCRAPER COFFEE GROUP
	9		9111.520	SPRING FOR SCRAPER SECTION 0.6 SPRING FOR SCRAPER SECTION 0.6
	10		U701.006	ФІКСУЮЧА СКОБА 3,2 (ЗАПІЗО) SAECO ANELLO ELASTICO 3,2
	11		9111.539.150	FORK FOR SCRAPER FORCELLA PER RASCHIATORE
	12		9110.067.150	SCRAPER ASS.FOR CAPPUCINAT. TUBE ASS.RASCHIATORE X SG500/700

Model Machine

MACSAE305

КАВОВИЙ АВТОМАТ OCS PHEDRA EVO 9GR 1C3 230/50 RI

	13		U110.013	БОЛТ МЕТАЛЕВИЙ 3,9X6,5 DIN 7981 F <i>SCREW AUT.TCB 3,9X6,5 DIN 7981 F</i>
	14		140321462	O-RING 2018 SILICONE <i>OR 2018 IN SILICONE</i>
	15		9972.057	КОРИЧНЕВА ГУМОВА ТРУБКА 5X8 2 МЕТРИ <i>TUBO SILICONE MARRON 5X8 L.2000 MM</i>
	16		1813.109.050	NOZZLES <i>NOZZLES</i>
	17		322001259	ПЛАСТИКОВА ВОРНОКА ПОДАЧІ КАВИ (ПЛАСТИК) ЧОРНИЙ <i>MOBILE SCRAPER GREY NARROW</i>
	18		9161.425	SPRING FOR SCRAPER <i>SPRING FOR SCRAPER</i>
	19		129851921	TSP SCREW M3X6 UNI 7688 SS <i>TSP SCREW M3X6 UNI 7688 SS</i>
	20		9161.037	LOWER PERCOLATOR FOR UNIT <i>DOCCIA INFERIORE X GRUPPO</i>
	21		11002626	ASS. COFFEE CONTAINER GREY 9 GR. <i>ASS. COFFEE CONTAINER GREY 9 GR.</i>
	22		9161.021.060	KEY FOR BREW UNIT BROWN <i>CHIAVE X GRUPPO CAFFE' MARRO</i>
	23		11005422	ЗАВАРЮВАЛЬНИЙ БЛОК 9GR SAECO 996530002882 <i>GRUPPO CAFFE' 9GR CRISTALLO 600</i>
	24		11013053	CARTER FOR DOSER UNIT <i>CARTER FOR DOSER UNIT</i>
	25		322005050	GROU.. EXPULS. BLACK D=40 UNIT9GR <i>GROU.. EXPULS. BLACK D=40 UNIT 9GR</i>

Model Machine

MACSAE305

КАБОВИЙ АВТОМАТ OCS PHEDRA EVO 9GR 1C3 230/50 RI

MACSAE305.T.0012

TAVOLA NR. 12 - ARTICOLO КАБОВИЙ АВТОМАТ OCS PHEDRA EVO 9GR 1C3 230/50 RI
BLK (10004854/10000068)

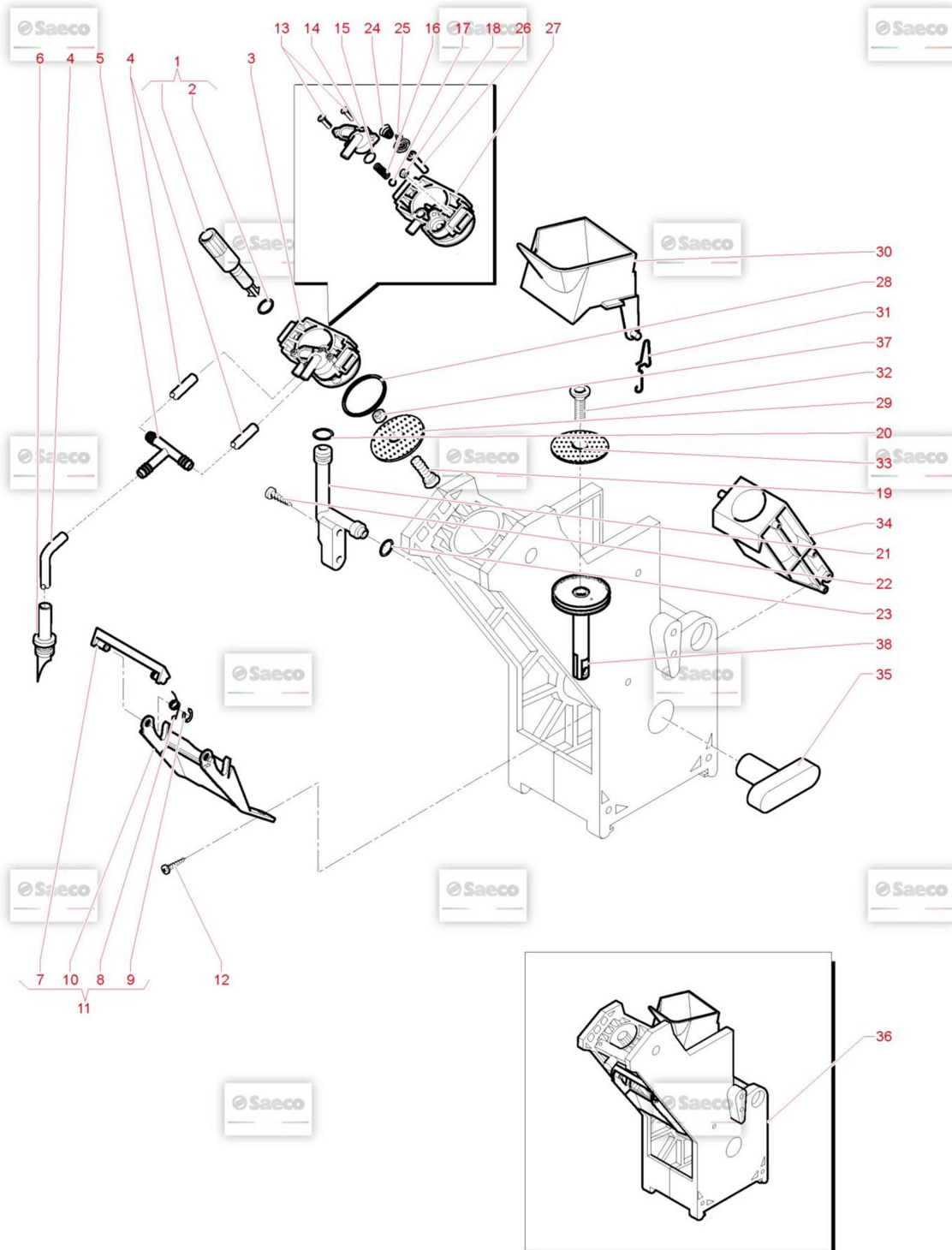



















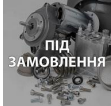





Model Machine

MACSAE305

КАВОВИЙ АВТОМАТ OCS PHEDRA EVO 9GR 1C3 230/50 RI



























PLK/1000105/1000000

Web	Pos.	Foto	Item - Replace by	Description
				<i>Press - CTRL + CLICK go to item in a new window</i> <i>Натисніть - Ctrl + права кнопка миші щоб відкрити запчастину в новому вікні</i>
	1		9169.A14.150	PIN FOR PERCOLATOR GREY ASS.PERNO X DOCCIA COMPLETO GRIGIO
	2		NM02.006	OR R5 TERMOIL OR R5 EPDM
	3		11007343	НОСИК В ЗБОРІ 10 ГРАМ ASS.COUNTERPISTON FRESH-BREW
	4		9972.057	КОРИЧНЕВА ГУМОВА ТРУБКА 5X8 2 МЕТРИ TUBO SILICONE MARRON 5X8 L.2000 MM
	5	 ПІД ЗАМОВЛЕННЯ	11007493	T CONNECTOR FOR BOILER P604 T CONNECTOR FOR BOILER P604
	6		9111.348	STRAIGHT DISPENSING NOZZLE UGELLO EROGAZIONE DIR.
	7		9111.537.150	GREY SCRAPER COFFEE GROUP GREY SCRAPER COFFEE GROUP
	8		9111.520	SPRING FOR SCRAPER SECTION 0.6 SPRING FOR SCRAPER SECTION 0.6
	9		U701.006	ФІКСУЮЧА СКОБА 3,2 (ЗАПІЗО) SAECO ANELLO ELASTICO 3,2
	10		9111.539.150	FORK FOR SCRAPER FORCELLA PER RASCHIATORE
	11		9110.067.150	SCRAPER ASS.FOR CAPPUCINAT. TUBE ASS.RASCHIATORE X SG500/700
	12		U110.013	БОЛТ МЕТАЛЕВИЙ 3,9X6,5 DIN 7981 F SCREW AUT.TCB 3,9X6,5 DIN 7981 F

Model Machine

MACSAE305



























КАВОВИЙ АВТОМАТ OCS PHEDRA EVO 9GR 1C3 230/50 RI

	13		U109.030	CAMOPI3 AUT.TCB 2,9X16 DIN 7981 C SCREW AUT.TCB 2,9X16 DIN 7981 C
	14		11003470	КРИШКА НОСИКА LID X COUNTERPISTON FRESH-BREW
	15		NM02.013	OR ORM 0080-15 TERMOIL OR ORM 0080-15 TERMOIL
	16		11028830	ПРУЖИНКА ДЛЯ FS400 ПІД ШАРИК ПОРШНЯ SPRING FOR FS400 COVER CHASSIS
	17		12001650	SPHERE TEFLON D.5 SPHERE TEFLON D.5
	18		U302.003	МЕТАЛЕВА ГАЙКА M4 UNI 5588 ZNP DADO ESAGONALE M4 UNI 5588 ZNP
	19		129852821	TSP SCREW M3X14 UNI 7688 SS TSP SCREW M3X14 UNI 7688 SS
	20		140320461	OR ORM 0080-20 TERMOIL OR ORM 0080-20 IN TERMOIL
	21		322000559	WATER FLOW PISTON GREY WATER FLOW PISTON GREY
	22		129512921	SCREW TCB TORX 10 AB 2,9X13 SHEET SS SCREW TCB TORX 10 2,9X13 SHEET SS
	23		140321462	O-RING 2018 SILICONE OR 2018 IN SILICONE
	24		11002603	SPING FOR MEMBRANE SPING FOR MEMBRANE
	25		11002625	MEMBRANE MEMBRANE

Model Machine

MACSAE305

КАВОВИЙ АВТОМАТ OCS PHEDRA EVO 9GR 1C3 230/50 RI

	26		11003471	PIN FOR MEMBRANE FRESH-BREW <i>PIN FOR MEMBRANE FRESH-BREW</i>
	27		11003469	COUNTERPISTON FRESH-BREW <i>COUNTERPISTON FRESH-BREW</i>
	28		NM01.044	OR ORM 0320-40 SILICONE PTFE/FDA <i>OR ORM 0320-40 SILICONE PTFE</i>
	29		9161.167	СИТО МЕТАЛЕБЕ D=35,8 SAECO 11008362 <i>PERCOLATOR D.35,8</i>
	30		11003529	HOPPER DOSER UNIT FRESH BREW <i>HOPPER DOSER UNIT FRESH BREW</i>
	31		126836618	SPRING H=28 NEW FOR SCRAPER <i>MOLLA H=28 NEW X RASCHIATORE</i>
	32		129851921	TSP SCREW M3X6 UNI 7688 SS <i>TSP SCREW M3X6 UNI 7688 SS</i>
	33		9161.037	LOWER PERCOLATOR FOR UNIT <i>DOCCIA INFERIORE X GRUPPO</i>
	34		11002626	ASS. COFFEE CONTAINER GREY 9 GR. <i>ASS. COFFEE CONTAINER GREY 9 GR.</i>
	35		9161.021.150	KEY FOR BREW UNIT GREY <i>KEY FOR BREW UNIT GREY</i>
	36		11007283	BREW UNIT 10GRAMS FRESH BREW <i>BREW UNIT 10GRAMS FRESH BREW</i>
	37		U301.003	ГАЙКА HEXAGONAL M3 UNI 5587 <i>NUT HEXAGONAL M3 UNI 5587</i>
	38		322005050	GROU.. EXPULS. BLACK D=40 UNIT9GR <i>GROU.. EXPULS. BLACK D=40 UNIT 9GR</i>

Model Machine

MACSAE305

КАБОВИЙ АВТОМАТ OCS PHEDRA EVO 9GR 1C3 230/50 RI

MACSAE305.T.0013



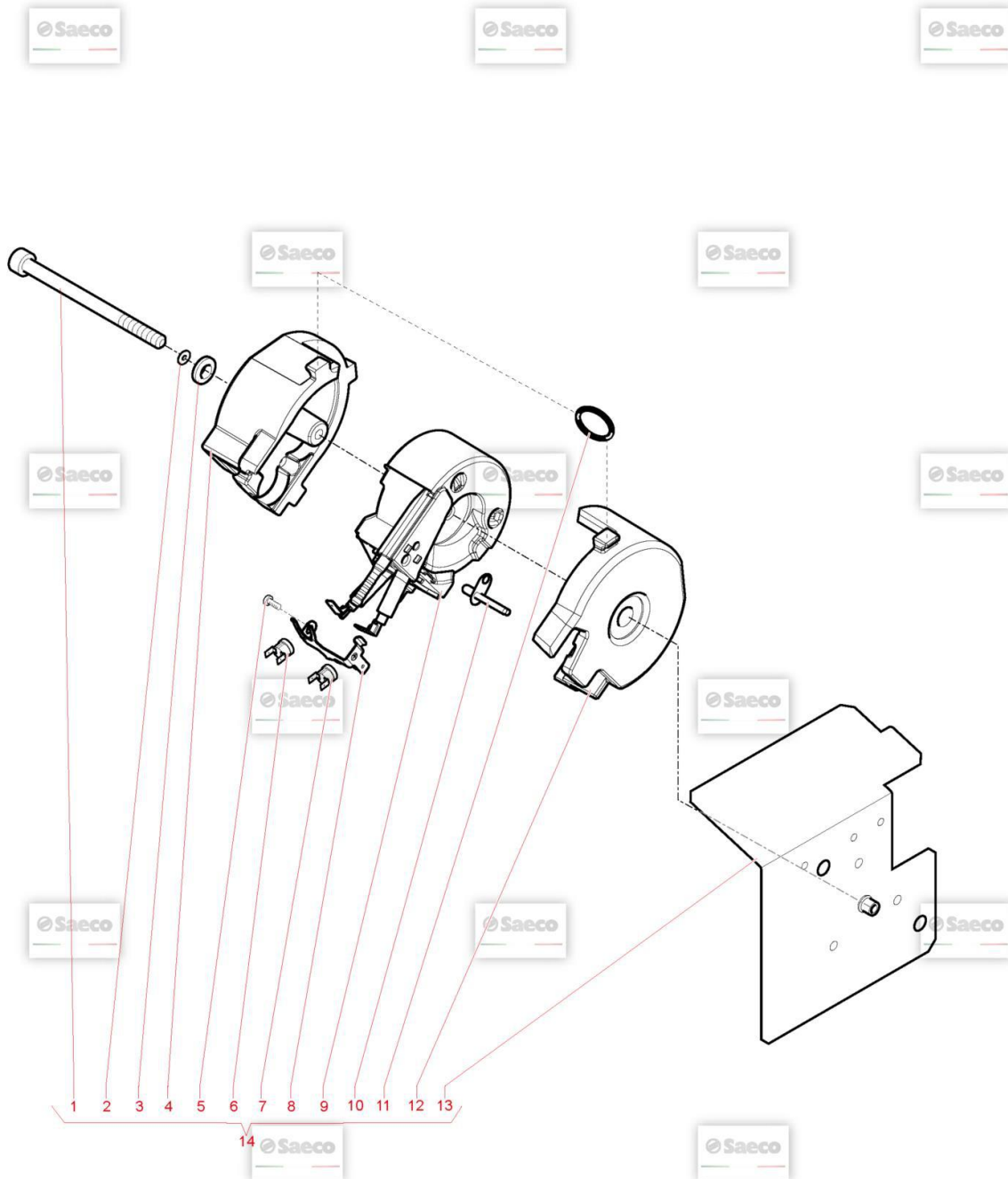









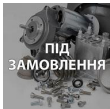



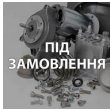

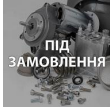



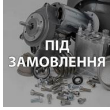

TAVOLA NR. 13 - ARTICOLO КАБОВИЙ АВТОМАТ OCS PHEDRA EVO 9GR 1C3 230/50 RI
BLK (10004854/10000068)

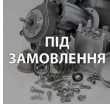

Model Machine

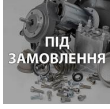
MACSAE305

КАВОВИЙ АВТОМАТ OCS PHEDRA EVO 9GR 1C3 230/50 RI

Web	Pos.	Foto	Item - Replace by	Description
				<i>Press - CTRL + CLICK go to item in a new window Натисніть - Ctrl + права кнопка миші щоб відкрити запчастину в новому вікні</i>
	1		12001395	SCREW TCEI M5,0X65 UNI 5931 8.8 B SCREW TCEI M5,0X65 UNI 5931 8.8 B
	2		U207.001	PLAIN WASHER 5,3X10 UNI 6592 GAL ROSETTA PIANA 5,3X10 UNI 6
	3		11013945	SPACER FASIT D.EXT.11 D.INT.5,5 #3 SPACER FASIT D.EXT.11 D.INT.5,5 #3
	4		263941	TERMOBLOCK THERMAL INSULATION REAR SHELL GUSCIO POSTERIORE TERMOISOLANTE TERMOB
	5		129573202	SCREW TCB TORX 20 M4X8 AUTOFORMING ZN-B SCREW TAPT M4X8 UNI 8112
	6		11005558	THERMOSTAT 190° NC FASTON 90° THERMOSTAT 190° NC FASTON 90°
	7		12000804	ТЕРМОСТАТ 190 1NT-08L-6067 THERMOSTAT 190° 1NT-08L-6067
	8		421944012251	ПЛАСТИНКА ФІКСАЦІЇ ТЕРМОСТАТІВ БОЙЛЕРУ TRX1 ACC. MOLLA FERM.TERMOS.CALD.TRX1 ACC.
	9		11033552	V4 TUB.BOILER 1300W 120V CULUS AS.CALD.TUB.V4 1300W 120V CULUS
	9		421944024121	БОЙЛЕР И ТЭН ДЛЯ КОФЕВАРКИ (КОФЕМАШИНЫ) XS4 1300W 230V ASS... TUB.BOILER XS4 1300W 230V ASSY.
	10		11009589	ДАТЧИК ПАРИ SG650 SAECO STEAM PROBE SG650
	11		NM03.013	OR 2,3X15 NBR OR 2,3X15 NBR

Model Machine

MACSAE305

КАВОВИЙ АВТОМАТ OCS PHEDRA EVO 9GR 1C3 230/50 RI



12

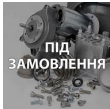

263940

TERMOBLOCK THERMAL INSULATINGFRONT SHELL
GUSCIO ANTERIORE TERMOISOLANTETERMOBL



13

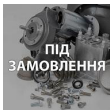

11013311

PHEDRA BOILERS SUPPORT PLATE
PHEDRA BOILERS SUPPORT PLATE



14

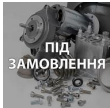

11033551

PHEDRA BOILERS SUPPORT PLATE 120V
ASS.PIASTRA SUP.CALD.TUB.PHEDRA TTT 120V



14

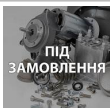

A26395000

RICAMBIO ASS.SUPP.CALDAIA85A007800
RICAMBIO ASS.SUPP.CALDAIA85A007800