

Model Machine

MACSAE027

SAECO PHEDRA ESPRESSO

MACSAE027.T.0001



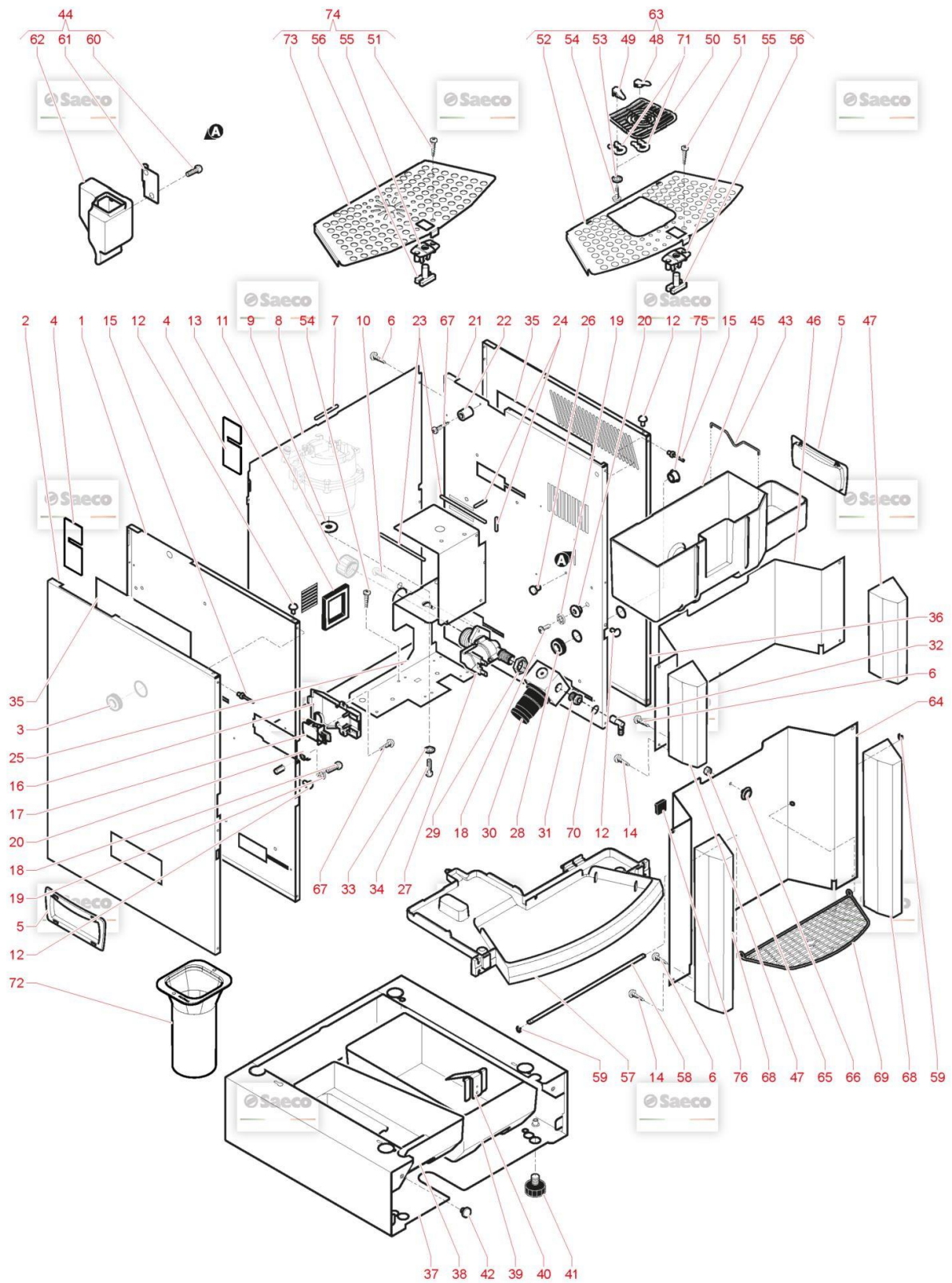









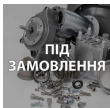

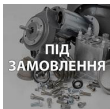

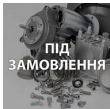

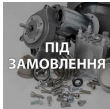

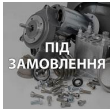

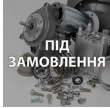

TAVOLA NR. 1 - ARTICOLO SAECO PHEDRA ESPRESSO

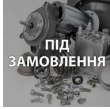

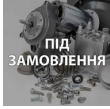
Model Machine

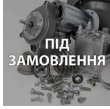
MACSAE027

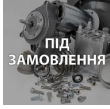

























SAECO PHEDRA ESPRESSO

Web	Pos.	Foto	Item - Replace by	Description
				<i>Press - CTRL + CLICK go to item in a new window Натисніть - Ctrl + права кнопка миші щоб відкрити запчастину в новому вікні</i>
	1		11008483	5P07 LEFT INSIDE LATERAL PANEL <i>5P07 LEFT INSIDE LATERAL PANEL</i>
	1		11032022	PHEDRA LEFT INTERNAL LATERAL PANEL <i>PHEDRA LEFT INTERNAL LATERAL PANEL</i>
	2		11010229	5P07 LEFT EXTERNAL LATERAL PANEL BLK <i>5P07 LEFT EXTERNAL LATERAL PANEL BLK</i>
	2		11032025	PHEDRA LEFT EXTERNAL LATERAL PANEL BLK <i>PHEDRA LEFT EXTERNAL LATERAL PANEL BLK</i>
	3		NE16.009	GROMMET NOSTRUM 10476.1.2 <i>GROMMET NOSTRUM 10476.1.2</i>
	4		11013519	SPACE FOR PANEL PHEDRA <i>SPACE FOR PANEL PHEDRA</i>
	5		11009070	LATERAL PANEL HANDLING PLATE <i>LATERAL PANEL HANDLING PLATE</i>
	6		U110.003	SCREW AUT.TCB 3,5X9,5 DIN 7981F <i>VITE AUT.TCB 3,5X9,5 DIN 798</i>
	7		11023545	PROFILE GES62F-A-C0 L.93 MM <i>PROFILE GES62F-A-C0 L.93 MM</i>
	8		11024108	PHEDRA REAR PANEL <i>PHEDRA REAR PANEL</i>
	8		11031964	PHEDRA REAR PANEL <i>PHEDRA REAR PANEL</i>
	9		9111.501	INSULATION WASHER <i>INSULATION WASHER</i>

Model Machine

MACSAE027

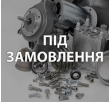









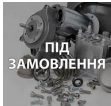

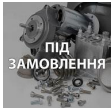

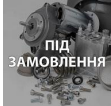

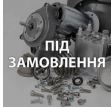

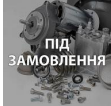

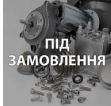





SAECO PHEDRA ESPRESSO

	10		U109.016	SCREW AUT.TCB 3,9X13 DIN 7981C SCREW AUT.TCB 3,9X13 DIN 7981 C
	11		NV03.002	КРИШКА КЛАПАНА ПОДАЧІ ВОДИ 3/4 "CAP 3/4 "KAPSTO 800R 3/4""
	12		NV01.009	RUBBER BUFFER GOMMINO PARACOLPI
	13		9111.088	ADHESIVE SEAL FOR ASPIRATOR ADHESIVE SEAL FOR ASPIRATOR
	14		U116.006	SCREW AUT.PT TCB 3,5X12 WN 1441 ZNP VITE AUT.PT TCB 3,5X12 WN 1441 ZNP
	15	 ПІД ЗАМОВЛЕННЯ	NF11.115	BLIND RIVETS BLIND RIVETS
	16	 ПІД ЗАМОВЛЕННЯ	11008501	SUPPORT FOR MICRO DOOR SUPPORT FOR MICRO DOOR
	17		NE05.039	BIPOLAR MICROSWITCH MICROINTERRUTTORE BIPOLARE
	17	 ПІД ЗАМОВЛЕННЯ	NE05.061	MICROSWITCH CHERRY D413 .V3LD MICROINT.BIPOLARE XTD 22AZ1
	18	 ПІД ЗАМОВЛЕННЯ	129768902	TC SCREW M5X16 UNI 6107 ZNP TC SCREW M5X16 UNI 6107 ZNP
	19	 ПІД ЗАМОВЛЕННЯ	U208.004	TOOTHED WASHER 3,8X7,5 UNI 3703 B TOOTHED WASHER 3,8X7,5 UNI 3703 B
	20	 ПІД ЗАМОВЛЕННЯ	11008858	LOCK BUSH LOCK BUSH
	21	 ПІД ЗАМОВЛЕННЯ	11007025	5P07 RIGHT INTERNAL LATERAL PANEL 5P07 RIGHT INTERNAL LATERAL PANEL
	21	 ПІД ЗАМОВЛЕННЯ	11021494	5P07 RIGHT INTERNAL LATERAL PANEL 5P07 RIGHT INTERNAL LATERAL PANEL

Model Machine

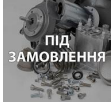
MACSAE027













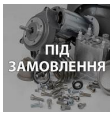

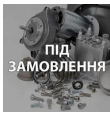

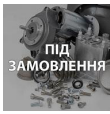

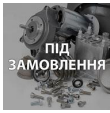

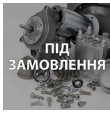

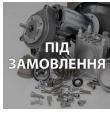

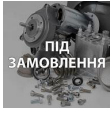
SAECO PHEDRA ESPRESSO

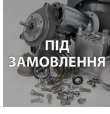
	21		11032020	PHEDRA RIGHT INTERNAL LATERALPANEL <i>PHEDRA RIGHT INTERNAL LATERAL PANEL</i>
	22		11009319	BUSH FOR BRACKET UPPER DOOR <i>BUSH FOR BRACKET UPPER DOOR</i>
	23		0875.442	SEAL AD U L.100 MM <i>SEAL AD U L.100 MM</i>
	24		0875.441	GUARNIZIONE AD U L.40 MM <i>GUARNIZIONE AD U L.40 MM</i>
	25		11008481	BOILER/E/V IN SUPPORT PLATE <i>BOILER/E/V IN SUPPORT PLATE</i>
	25		11013989	PHEDRA BOILERS SUPPORT PLATE <i>PHEDRA BOILERS SUPPORT PLATE</i>
	26		9111.411	RUBBER BUFFER FOR COMPARTMENT <i>GOMMINO PARACOLPI X VANO</i>
	27		11008834	SOLENOID VALVE <i>SOLENOID VALVE</i>
	28		NE16.002	GROMMET D.11X20,5XH.7 <i>GROMMET D.11X20,5XH.7</i>
	29		WGAND01/016	1/4" GAS NUT <i>1/4" GAS NUT</i>
	30		NV99.007	ЦЕНТРАЛЬНИЙ КЛАПАН ВОДИ 1BAR 1/4 MRABIT 52 PHILIPS SAECO 9965... <i>PRESS. REDUCER .1BAR 1/4 MRABIT 52</i>
	31		9181.404	REDUCTION MF 1/4"X1/8" TEA <i>REDUCTION MF 1/4"X1/8" TEA</i>
	32		11001054	СОЕДИНИТЕЛЬНЫЙ УГОЛОК 90° К НАСОСУ P0049/B PHILIPS SAECO 996... <i>BLK PUMP OUTLET 90° CONNECTOR P0049/B</i>
	33		U208.003	TOOTHED WASHER 5,1X9 BRU <i>TOOTHED WASHER 5,1X9 BRU</i>

Model Machine

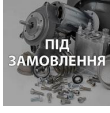
MACSAE027

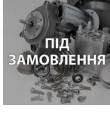



























SAECO PHEDRA ESPRESSO

	34		U046.005	SCREW TE M5,0X10 WITH WASHER <i>SCREW TE M5,0X10 WITH WASHER</i>
	35	 ПІД ЗАМОВЛЕННЯ	15001721	ADHESIVE LABEL GRILL PHEDRA <i>ADHESIVE LABEL GRILL PHEDRA</i>
	36	 ПІД ЗАМОВЛЕННЯ	11010310	5P07 RIGHT EXTERNAL LATERAL PANEL BLK <i>5P07 RIGHT EXTERNAL LATERAL PANEL BLK</i>
	36	 ПІД ЗАМОВЛЕННЯ	11021358	5P07 LEFT EXTERNAL LATERAL PANEL BLK <i>5P07 LEFT EXTERNAL LATERAL PANEL BLK</i>
	36	 ПІД ЗАМОВЛЕННЯ	11032028	PHEDRA RIGHT EXTERNAL LATERALPANEL BLK <i>PHEDRA RIGHT EXTERNAL LATERAL PANEL BLK</i>
	37	 ПІД ЗАМОВЛЕННЯ	11010228	RAISED 120MM 5P07 <i>RAISED 120MM 5P07</i>
	38	 ПІД ЗАМОВЛЕННЯ	11013017	LIQUIDS TANK FOR PHEDRA RAISED <i>LIQUIDS TANK FOR PHEDRA RAISED</i>
	39	 ПІД ЗАМОВЛЕННЯ	11013018	GROUND'S CONTAINER X PHEDRA RAISED <i>GROUND'S CONTAINER X PHEDRA RAISED</i>
	40	 ПІД ЗАМОВЛЕННЯ	11022525	SWITCH PLATE <i>SWITCH PLATE</i>
	41		NV01.015	FOOT D.22 H.18 M6 <i>PIEDINO D.22 H.18 M6</i>
	42	 ПІД ЗАМОВЛЕННЯ	9991.206	MAGNET D.13 H.4,5 M5 MALE <i>MAGNET D.13 H.4,5 M5 MALE</i>
	43	 ПІД ЗАМОВЛЕННЯ	11013006	SPECIAL SPRING <i>SPECIAL SPRING</i>
	44	 ПІД ЗАМОВЛЕННЯ	11013321	COIN CASE PHEDRA <i>COIN CASE PHEDRA</i>

Model Machine

MACSAE027











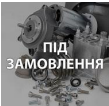

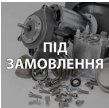













SAECO PHEDRA ESPRESSO

	45		11007012	BEIGE DRAWER TRUST <i>5P07 WATER RECOVER BOX BLK</i>
	46		11008461	INOX PLATE FOR WATER TUB <i>INOX PLATE FOR WATER TUB</i>
	47		11007798	CEGMENT BLK 5P07 <i>LATERAL INSERT TANK BLK 5P07</i>
	47		11023135	LATERAL INSERT TANK BLK PHEDRA <i>LATERAL INSERT TANK BLK PHEDRA</i>
	48		11022258	PHEDRA RX PLASTIC GRATE POSITIONING INSE <i>PHEDRA RX PLASTIC GRATE POSITIONING INSE</i>
	49		11022257	PHEDRA LX PLASTIC GRATE POSITIONING INSE <i>PHEDRA LX PLASTIC GRATE POSITIONING INSE</i>
	50		11022256	COFFEE GRILL FOR PHEDRA <i>COFFEE GRILL FOR PHEDRA</i>
	51		U142.008	PANELVIT TSP 3,5X12 DIN 7505 AGAL <i>PANELVIT TSP 3,5X12 DIN 7505 A GAL</i>
	52		11022259	PHEDRA GRATE FOR PLASTIC POSITIONING <i>PHEDRA GRATE FOR PLASTIC POSITIONING</i>
	53		U201.001	PLAIN WASHER 3,2X9 DIN 7349 GALV. <i>PLAIN WASHER 3,2X9 DIN 7349 GALV.</i>
	54		U116.005	SCREW AUT.PT TCB 3,0X8 WN 1441 <i>VITE AUT.PT TCB 3,0X8 WN 1441 ZNP</i>
	55		11010800	INOX GRID FLOATING SIGNAL SUPPORT <i>INOX GRID FLOATING SIGNAL SUPPORT</i>
	56		145501211	RED FLOAT FOR DRIP TRAY SMART <i>RED FLOAT FOR DRIP TRAY SMART</i>
	57		11007013	5P07 WATER RECOVER BOX BLK <i>5P07 WATER RECOVER BOX BLK NUOVO PREZZO 8,95</i>

Model Machine

MACSAE027









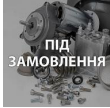

SAECO PHEDRA ESPRESSO

	57		11023139	5P07 WATER RECOVER BOX BLK CSA5VA <i>5P07 WATER RECOVER BOX BLK CSA 5VA</i>
	58		11013030	ROTATION PIN COFFEE GRILL FORRAISED <i>ROTATION PIN COFFEE GRILL FOR RAISED</i>
	59		U701.006	ФІКСУЮЧА СКОБА 3,2 (ЗАПІЗО) SAECO <i>ANELLO ELASTICO 3,2</i>
	60		U044.018	SCREW TSPC M5,0X8 UNI 7688 GALV. <i>SCREW TSPC M5,0X8 UNI 7688 GALV.</i>
	61		11012740	PLATE FOR COIN BOX PHEDRA <i>PLATE FOR COIN BOX PHEDRA</i>
	62		11011322	COIN CASE 5P07 <i>COIN CASE 5P07</i>
	63		11023494	PHEDRA GRATE FOR INOX-PLASTIC <i>PHEDRA GRATE FOR INOX-PLASTIC</i>
	64		11010552	INOX PLATE FOR TANK "L.+120MM" <i>INOX PLATE FOR TANK "L.+120MM"</i>
	65		U324.006	ШАЙБА М4 <i>NUT M4 FLANGED INDENTED BASE</i>
	66		11023698	MAGNET GRATE PHEDRA <i>MAGNET GRATE PHEDRA</i>
	67		U109.013	SCREW TCB 3,5X13 UNI 6954 NIK <i>SCREW TCB 3,5X13 UNI 6954 NIK</i>
	68		11008363	LATERAL INSERT HIGH TANK 5P07 <i>LATERAL INSERT HIGH TANK 5P07</i>
	69		11013019	COFFEE GRILL FOR PHEDRA RAISED <i>COFFEE GRILL FOR PHEDRA RAISED</i>
	70		140321961	ПРОКЛАДКА O-RING ДЛЯ КАВОМАШИНИ SAECO 2031 TERMOIL <i>OR 2031 IN TERMOIL</i>

Model Machine

MACSAE027

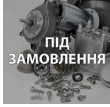
SAECO PHEDRA ESPRESSO

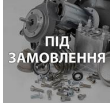
	71		9011.144	SS FORK FOR TUBE D=4 <i>FORCELLA X TUBO D.4</i>
	72		11032178	COFFEE CONVEY <i>COFFEE CONVEY</i>
	73		11032039	PHEDRA GRATE <i>PHEDRA GRATE</i>
	74		11032384	РЕШІТКА КАПЛЕЗБІРНИКА PHEDRA <i>PHEDRA GRATE FOR INOX</i>
	75		12001971	PLUG BLK F. 15,9-SP. MAX 1,6 <i>PLUG BLK F. 15,9-SP. MAX 1,6</i>
	76		NV01.001	ADHESIVE FOOT <i>PIEDINO ADESIVO</i>

Model Machine

MACSAE027

SAECO PHEDRA ESPRESSO

MACSAE027.T.0002

TAVOLA NR. 2 - ARTICOLO SAECO PHEDRA ESPRESSO

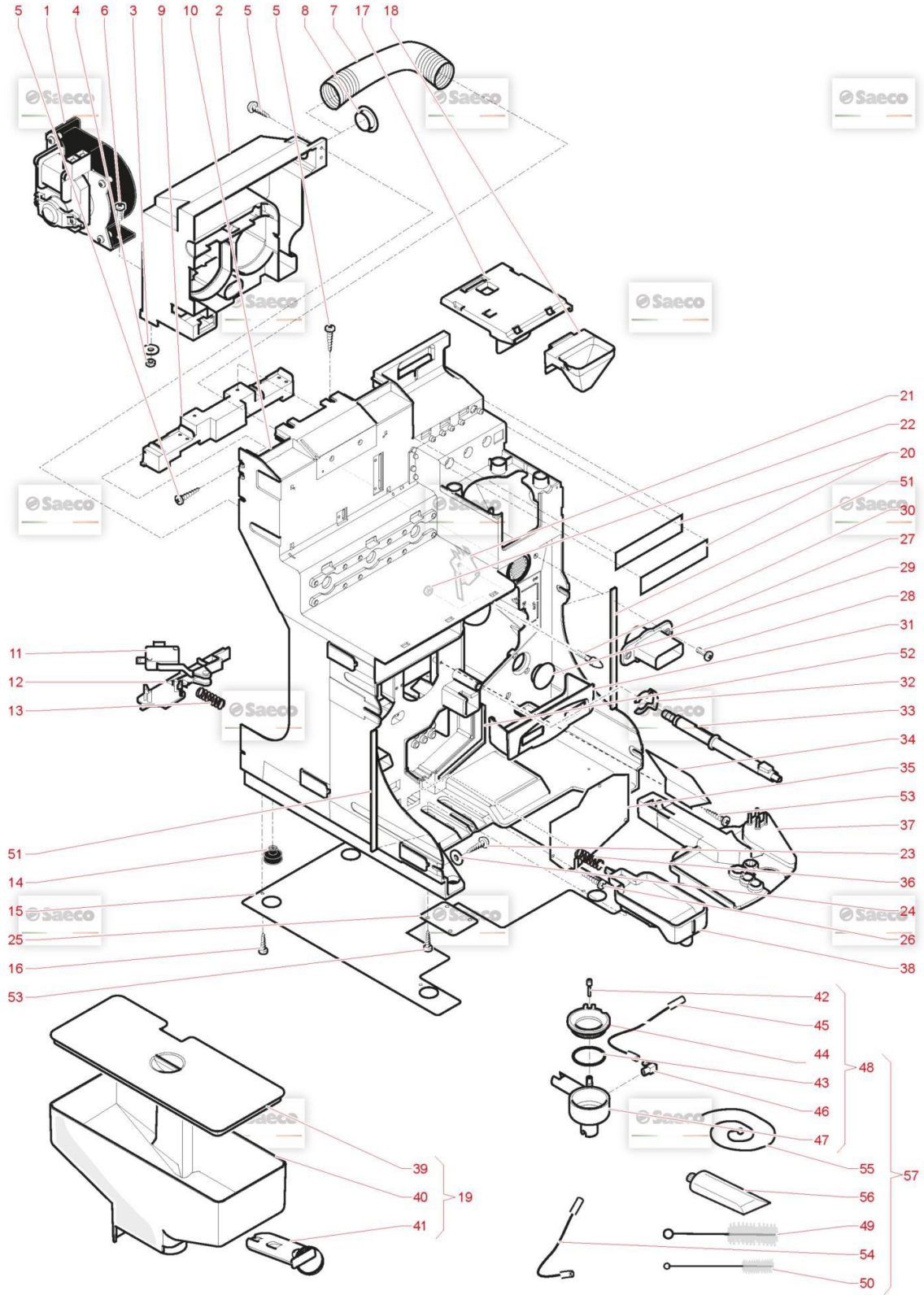

Model Machine

MACSAE027

SAECO PHEDRA ESPRESSO

Web Pos. Foto Item - Replace by Description



*Press - CTRL + CLICK go to item in a new window
Натисніть - Ctrl + права кнопка миші щоб відкрити запчастину в новому вікні*



1



9121.009.00A

MOTOR WITH FAN 230V
MOTORE CON VENTOLA 230V



1



9121.009.00F

MOTOR WITH FAN 120V
MOTOR WITH FAN 120V



1

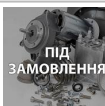

9121.009.00N

MOTOR WITH FAN 220V 60HZ
MOTOR WITH FAN 220V 60HZ



1

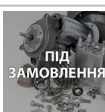

9121.009.00R

MOTOR WITH FAN 100V 50/60HZ
MOTOR WITH FAN 100V 50/60HZ



2

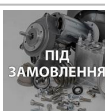

11007018

5P07 SOLUBLES MOTORS SUPPORT
5P07 SOLUBLES MOTORS SUPPORT



3



U207.002

PLAIN WASHER 4,3X9 UNI 6592 GAL
ROSETTA PIANA 4,3X9 UNI 6592 ZNP



4



U302.003

METALEVA GAIKA M4 UNI 5588 ZNP
DADO ESAGONALE M4 UNI 5588 ZNP



5



U110.005

SCREW AUT.TCB 3,9X9,5 DIN 7981F
VITE AUT.TCB 3,9X9,5 DIN 798



6

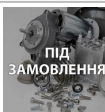

U046.007

SCREW TEFZ M4,0X12 GALV.
SCREW TEFZ M4,0X12 GALV.



7

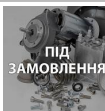

11023377

TUBE
TUBE



8



12001070

POLYCAP COVER LPN600-053-IDPE
POLYCAP COVER LPN600-053-IDPE



9



11008350

UPPER HINGES PLATE
UPPER HINGES PLATE



10

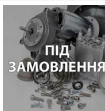





























11007010

5P07 MAIN ASSEMBLING PLATE
5P07 MAIN ASSEMBLING PLATE

Model Machine

MACSAE027























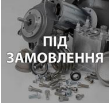

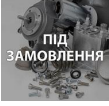
SAECO PHEDRA ESPRESSO

	11		NE05.059	МИКРОПЕРЕМИКАЧ НА ОБЕРТАННЯ РУКИ L=25 BIANCHI 26005136 <i>MICROINT.SAIA C/ROTELLA L=25</i>
	12		9161.202.150	GREY GROUNDS MICRO COMPENSATOR M5000 <i>BILANCERE X MICRO FONDI</i>
	13		9161.221	SS GROUND.MICRO SUPP.COMPENSATOR SPRING <i>SPRING GROUND.MICROSUPP.COMPENSA</i>
	14		11011159	FOOT RUBBER 85SH FOR 5P07 <i>FOOT RUBBER 85SH FOR 5P07</i>
	15		11023088	LOWER SHEET PLATE PHEDRA BLK <i>LOWER SHEET PLATE PHEDRA BLK</i>
	16		U116.005	SCREW AUT.PT TCB 3,0X8 WN 1441 <i>VITE AUT.PT TCB 3,0X8 WN 1441 ZNP</i>
	17		11011575	SUPPORTO CONTENITORI SOLUBILISMALL 5P07 <i>SUPPORTO CONTENITORI SOLUBILI SMALL 5P07</i>
	18		11011573	5P07 INSTANT SOLUBLE CONVEYOR <i>5P07 INSTANT SOLUBLE CONVEYOR</i>
	19		11008835	COFFEE TANK ASSEMBLY 5P07 <i>COFFEE TANK ASSEMBLY 5P07</i>
	20		0801.140	2 SIDE ADH. TAPE CABLE CHANN.SUPP <i>2 SIDE ADH. TAPE CABLE CHANN. SUPP</i>
	20		15001860	ETICHETTA ADESIVA 92X30MM PHEDRA <i>ETICHETTA ADESIVA 92X30MM PHEDRA</i>
	21		NE05.018	MICROSWITCH <i>MICROINTERRUTTORE SAECO XCG5-81-P5</i>
	22		U302.001	NUT HEXAGONAL M5 UNI 5588 <i>DADO ESAGONALE M5 UNI 5</i>
	23		U110.003	SCREW AUT.TCB 3,5X9,5 DIN 7981F <i>VITE AUT.TCB 3,5X9,5 DIN 798</i>

Model Machine

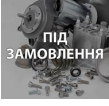
MACSAE027













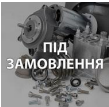











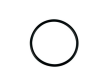

SAECO PHEDRA ESPRESSO

	24		U207.009	PLAIN WASHER 5,5X15 UNI 6593 GA <i>PLAIN WASHER 5,5X15 UNI 6593 GA</i>
	25		11011330	PLATE CONVEYER H2O CONTAINER RISE <i>PLATE CONVEYER H2O CONTAINER RISE</i>
	26		U142.008	PANELVIT TSP 3,5X12 DIN 7505 AGAL <i>PANELVIT TSP 3,5X12 DIN 7505 A GAL</i>
	27		11007019	CONVEYER ASP.3MIXER 5P07 <i>CONVEYER ASP.3MIXER 5P07</i>
	28		U043.015	SCREW TCBC M5,0X12 UNI 7687 GALV. <i>SCREW TCBC M5,0X12 UNI 7687 GALV.</i>
	29		12001365	CORK KAP 520 SFL 28 X 0,8-2,5BLACK <i>CORK KAP 520 SFL 28 X 0,8-2,5 BLACK</i>
	30		11006046	PEG FOR BOILER <i>PEG FOR BOILER</i>
	31		11007799	BOX MIXERS ASPIRATION 5P07 <i>BOX MIXERS ASPIRATION 5P07</i>
	32		U701.003	SNAP RING 7 UNI 7434 <i>ANELLO ELASTICO 7 UNI 7434</i>
	33		11013846	ASS.TUBE CAPPUCCINATORE PHEDRA <i>ASS.TUBE CAPPUCCINATORE PHEDRA</i>
	34		11013141	PHEDRA WASTE CONTAINER PLATE <i>PHEDRA WASTE CONTAINER PLATE</i>
	35		11008460	VAIN OF DRAIN COVER PLATE <i>VAIN OF DRAIN COVER PLATE</i>
	36		11011321	SPECIAL SPRING D.5 X L.38 5P07 <i>SPECIAL SPRING D.5 X L.38 5P07</i>

Model Machine

MACSAE027

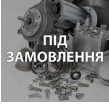











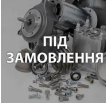

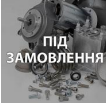

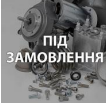

SAECO PHEDRA ESPRESSO

	37		11007011	NOZZLES SUPPORT <i>5P07 NOZZLES SUPPORT</i>
	38		11010482	H120 CONVEYOR 5P07 <i>H120 CONVEYOR 5P07</i>
	39		11007015	5P07 COFFEE CONTAINER COVER <i>COPERCHIO CONT.CAFFE' IN GRANI 5P07 COFFEE CONTAINER COVER</i>
	40		11007014	COFFEE CONTAINER 5P07 <i>COFFEE CONTAINER 5P07</i>
	41		11010736	ASS.GUILLOTINE COFFEE (1813.027) <i>ASS.GUILLOTINE COFFEE</i>
	42		11013988	PIN BRASS FOR CAPPUCINATORE TEA <i>PIN BRASS FOR CAPPUCINATORE TEA</i>
	42		11022783	PIN BRASS FOR CAPPUCINATORE TEA PLUS <i>PIN BRASS FOR CAPPUCINATORE TEA PLUS</i>
	42		148870150	BLACK CAPPUCINATORE PIN <i>SPILLO X CAPPUCINATORE NERO</i>
	43		140322500	ПРОКЛАДКА O-RING 2118 SH70 BIANCHI 36363116-01, SAECO 140322500 <i>OR 2118 IN NITRIL RUBBER</i>
	44		142801650	BLACK CAPPUCINAT.CASING LID NEUTRAL <i>BLACK CAPPUCINAT.CASING LID NEUTRAL</i>
	45		9972.072	SILICONE TUBE 3X5,5 L.600 MM DS <i>SILICONE TUBE 3X5 L.600 MM</i>
	46		9991.122.050	CONN. FOR CAPPUCINATORE BLACK <i>RACCORDO X CAPPUCINATORE NERO</i>
	47		142901350	BLACK CAPPUCINATORE CASING <i>BLACK CAPPUCINATORE CASING</i>
	48		11021694	BLACK CAPPUCINATORE ASS. <i>BLACK CAPPUCINATORE ASS.</i>

Model Machine

MACSAE027

SAECO PHEDRA ESPRESSO

	48		142520150	CAPPUCCINATORE AS.NEUTRAL BLACK <i>AS.CAPPUCCINATORE NEUTRO NER</i>
	49		12000431	BRUSH D.12 <i>BRUSH D.12</i>
	50		12000430	BRUSH D.6 <i>BRUSH D.6</i>
	51		11032541	ASIDE PANELS' SPECIAL SEAL <i>ASIDE PANELS' SPECIAL SEAL</i>
	52		11013140	SEAL FOR DRAIN VAIN PHEDRA L.115 <i>SEAL FOR DRAIN VAIN PHEDRA L.115</i>
	53		U116.006	SCREW AUT.PT TCB 3,5X12 WN 1441 ZNP <i>VITE AUT.PT TCB 3,5X12 WN 1441 ZNP</i>
	54		9972.056	SILICONE TUBE 3,5X6 L=500 MM DS <i>SILICONE TUBE 3,5X6 L=500 MM DS</i>
	55		1022.018	SCRAPER ASS.FOR CAPPUCCINAT. TUBE <i>ASS.RASCHIATORE X TUBO CAPPUCCINO</i>
	56		11005044	SAECO KLUBERLUB NH1 11-222 TUBE 5GR. <i>SAECO KLUBER TRIBOSTAR SIL 2 TUBE 5GR.</i>
	57		11024106	SACK PHEDRA CAPPUCCINO ACCESSORIES <i>SACK PHEDRA CAPPUCCINO ACCESSORIES</i>

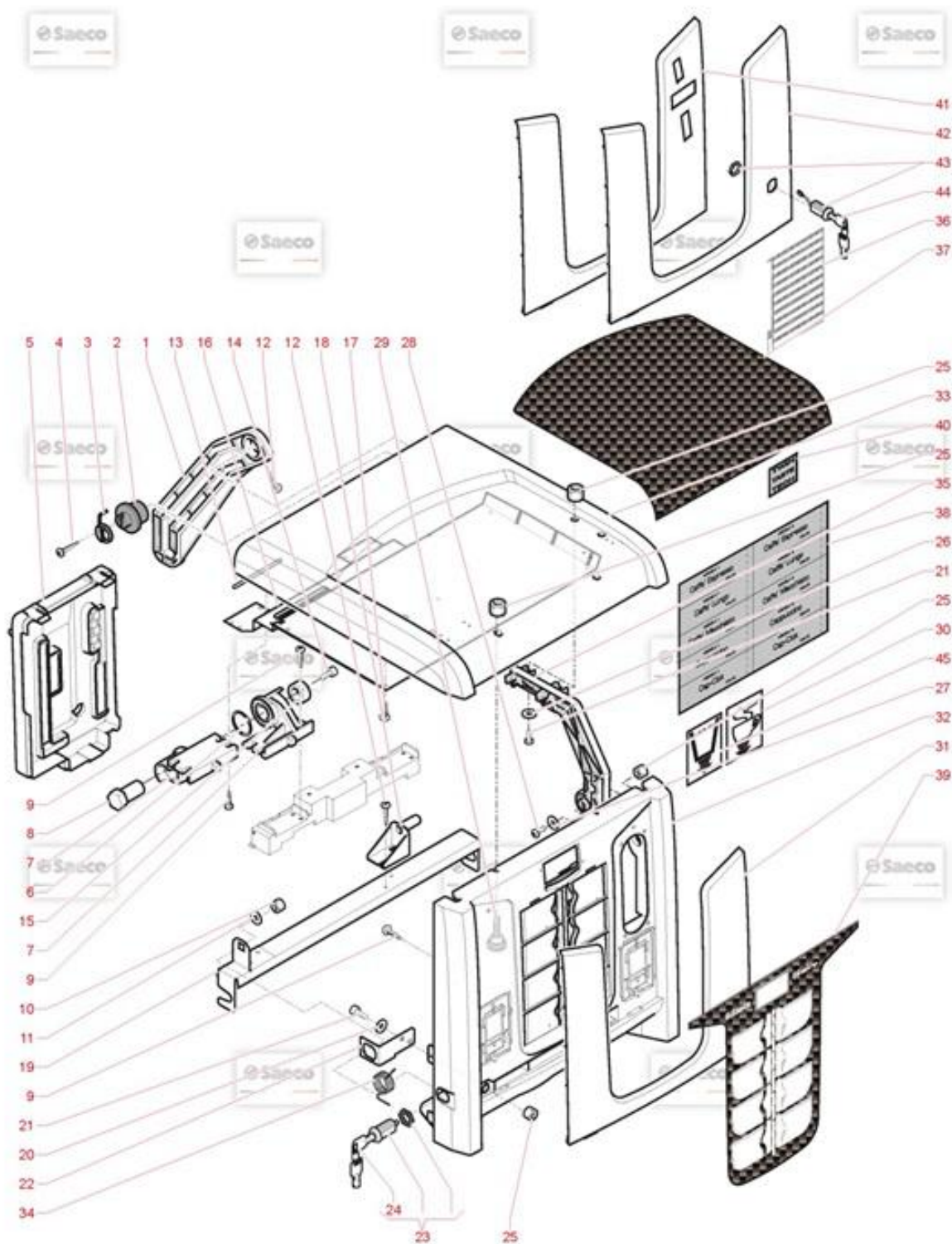

Model Machine

MACSAE027

SAECO PHEDRA ESPRESSO

Web Pos. Foto Item - Replace by Description



Press - CTRL + CLICK go to item in a new window

Натисніть - Ctrl + права кнопка миші щоб відкрити запчастину в новому вікні



1

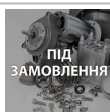

11009374

DOOR STIRRUP UPPER 5P07
DOOR STIRRUP UPPER 5P07



2



11009376

PIN FOR DOOR STIRRUP UPPER 5P07
PIN FOR DOOR STIRRUP UPPER 5P07



3



11009556

SPRING RIGHT FOR DOOR STIRRUP5P07
SPRING RIGHT FOR DOOR STIRRUP 5P07



4

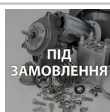

U111.001

SCREW AUT.TSP 2,9X9,5 DIN 7982C
SCREW AUT.TSP 2,9X9,5 DIN 7982C



5



11007795

CPU CARTER BLK 5P07
CPU CARTER BLK 5P07



6

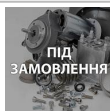

NM01.026

O-RING 121 SILICONE
OR 121 SILICONE



7



11007023

HINGE FOR ROOF 5P07
CERNIERA X TETTO 5P07 HINGE FOR ROOF 5P07



8

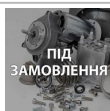

11008967

PIN FOR HINGE 5P07
PIN FOR HINGE 5P07



9



U116.006

SCREW AUT.PT TCB 3,5X12 WN 1441 ZNP
VITE AUT.PT TCB 3,5X12 WN 1441 ZNP



10



U302.006

NUT HEXAGONAL M10 UNI 5588
DADO ESAGONALE M10 UNI 5



11



U208.008

TOOTHED WASHER 10,5X18 UNI 3703 G
ROSETTA DENT. 10,5X18 UNI 3



12

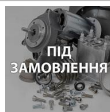

U110.003

SCREW AUT.TCB 3,5X9,5 DIN 7981F
VITE AUT.TCB 3,5X9,5 DIN 798



13













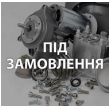

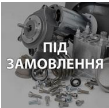













0875.441

GUARNIZIONE AD U L.40 MM
GUARNIZIONE AD U L.40 MM

Model Machine

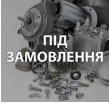
MACSAE027























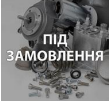

SAECO PHEDRA ESPRESSO

	14		U023.019	SCREW TCEI M8X20 UNI 5931 ZIN <i>SCREW TCEI M8X20 UNI 5931 ZIN</i>
	15		11010862	BUSH HINGE 5P07 <i>BUSH HINGE 5P07</i>
	16		11011549	UPPER DOOR REINFORCING PLATE <i>UPPER DOOR REINFORCING PLATE</i>
	17		U109.003	SCREW TCB 3,5X9,5 DIN 7981 C NICK <i>SCREW TCB 3,5X9,5 DIN 7981 C NICK</i>
	18		11008351	CLOSING DOOR PLATE SUPPORT <i>CLOSING DOOR PLATE SUPPORT</i>
	19		11008487	SUPPORT PLATE FOR CLOSING DOOR <i>SUPPORT PLATE FOR CLOSING DOOR</i>
	20		U208.006	TOOTHED WASHER 6,4X11 UNI 3703 <i>ROSETTA DENT. 6,4X11 UNI 3</i>
	21		U043.015	SCREW TCBC M5,0X12 UNI 7687 GALV. <i>SCREW TCBC M5,0X12 UNI 7687 GALV.</i>
	22		11008488	LOCK REINFORCING PLATE <i>LOCK REINFORCING PLATE</i>
	23		12001011	LOCK MERONI 3351MM.3190SX1U KA-4332143N <i>LOCK MERONI 3351MM.3190SX1U KA-4332143N</i>
	24		1602.R02	KEY FOR MERONILOCK <i>KEY FOR MERONILOCK</i>
	25		U301.002	HEXAGONAL NUT M5 UNI 5587 <i>HEXAGONAL NUT M5 UNI 5587</i>
	26		U207.001	PLAIN WASHER 5,3X10 UNI 6592 GAL <i>ROSETTA PIANA 5,3X10 UNI 6</i>
	27		U212.005	WASHER 5,3X20X1,5 GALV. <i>WASHER 5,3X20X1,5 GALV.</i>

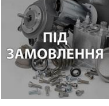
Model Machine

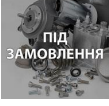
MACSAE027











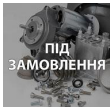

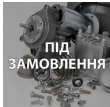

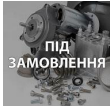

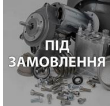

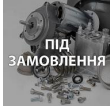

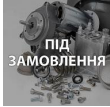

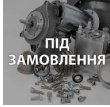

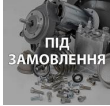

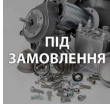
SAECO PHEDRA ESPRESSO

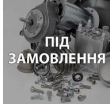
	28		U043.014	SCREW TCBC M5,0X20 UNI 7687 GALV. <i>SCREW TCBC M5,0X20 UNI 7687 GALV.</i>
	29		12002033	KNOB D.18 M5X25 <i>KNOB D.18 M5X25</i>
	30		15004225	ADHESIVE LABEL CUP SETTING PHEDRA <i>ADHESIVE LABEL CUP SETTING PHEDRA</i>
	31		11007797	FRONTAL PANEL SP 5P07 <i>FRONTAL PANEL SP 5P07</i>
	32		11007021	5P07 UPPER DOOR BLK <i>5P07 UPPER DOOR BLK</i>
	32		11023131	PHEDRA UPPER DOOR BLK <i>PHEDRA UPPER DOOR BLK</i>
	33		11007020	ВЕРХНЯ КРИШКА 5P07 ЧОРНА <i>5P07 UPPER DOOR BLK</i>
	33		11023133	PHEDRA UPPER DOOR BLK CSA 5VA <i>PHEDRA UPPER DOOR BLK CSA 5VA</i>
	34		11025929	ПРУЖИНА ЗАМКА ДВЕРИ PHEDRA <i>MOLLA CONTRASTO SERRATURA SPORT. PHEDRA</i>
	35		11009375	ROTATION STIRRUP UPPER 5P07 <i>ROTATION STIRRUP UPPER 5P07</i>
	36		0701.995	PRICE LABELS BLACK EURO <i>PRICE LABELS BLACK EURO</i>
	36		0775.989	PRICE LABELS WHITE EURO <i>PRICE LABELS WHITE EURO</i>
	37		11008739	ADHESIVE FRONT PLATE FOR UPPERCOVER <i>ADHESIVE FRONT PLATE FOR UPPER COVER</i>

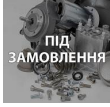
Model Machine

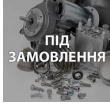
MACSAE027

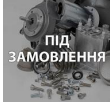









SAECO PHEDRA ESPRESSO

	37		11032036	ADHESIVE FRONT PLATE FOR UPPERCOVER <i>ADHESIVE FRONT PLATE FOR UPPER COVER</i>
	38		15001435	PRODUCTS LABEL'S SHEET 5P07 ITA <i>PRODUCTS LABEL'S SHEET 5P07 ITA</i>
	38		15001551	PRODUCTS LABEL'S SHEET 5P07 ENG <i>PRODUCTS LABEL'S SHEET 5P07 ENG</i>
	38		15001552	PRODUCTS LABEL'S SHEET 5P07 FRA <i>PRODUCTS LABEL'S SHEET 5P07 FRA</i>
	38		15001553	PRODUCTS LABEL'S SHEET 5P07 DE <i>PRODUCTS LABEL'S SHEET 5P07 DE</i>
	38		15001554	PRODUCTS LABEL'S SHEET 5P07 SPA <i>PRODUCTS LABEL'S SHEET 5P07 SPA</i>
	38		15001555	PRODUCTS LABEL'S SHEET 5P07 POR <i>PRODUCTS LABEL'S SHEET 5P07 POR</i>
	38		15001556	PRODUCTS LABEL'S SHEET 5P07 NL <i>PRODUCTS LABEL'S SHEET 5P07 NL</i>
	38		15001889	INSTRUCTION SHEET PHEDRA PRODUCT <i>INSTRUCTION SHEET PHEDRA PRODUCT</i>
	38		15004160	PRODUCTS LABEL'S SHEET PHEDRANL <i>PRODUCTS LABEL'S SHEET PHEDRA NL</i>
	39		11008740	ADHESIVE FRONT PLATE FOR TOUCHPANEL <i>ADHESIVE FRONT PLATE FOR TOUCH PANEL</i>
	39		11032035	ADHESIVE FRONT PLATE FOR TOUCHPANEL <i>MOSTRINA ADESIVA NEW X TAST.SPORT.PHEDRA</i>
	39		11032242	ADHESIVE FRONT PLATE FOR TOUCHPANEL <i>ADHESIVE FRONT PLATE FOR TOUCHPANEL</i>
	40		15002044	LABEL TWIN TASTE TECH GREY <i>LABEL TWIN TASTE TECH GREY</i>

Model Machine

MACSAE027

SAECO PHEDRA ESPRESSO



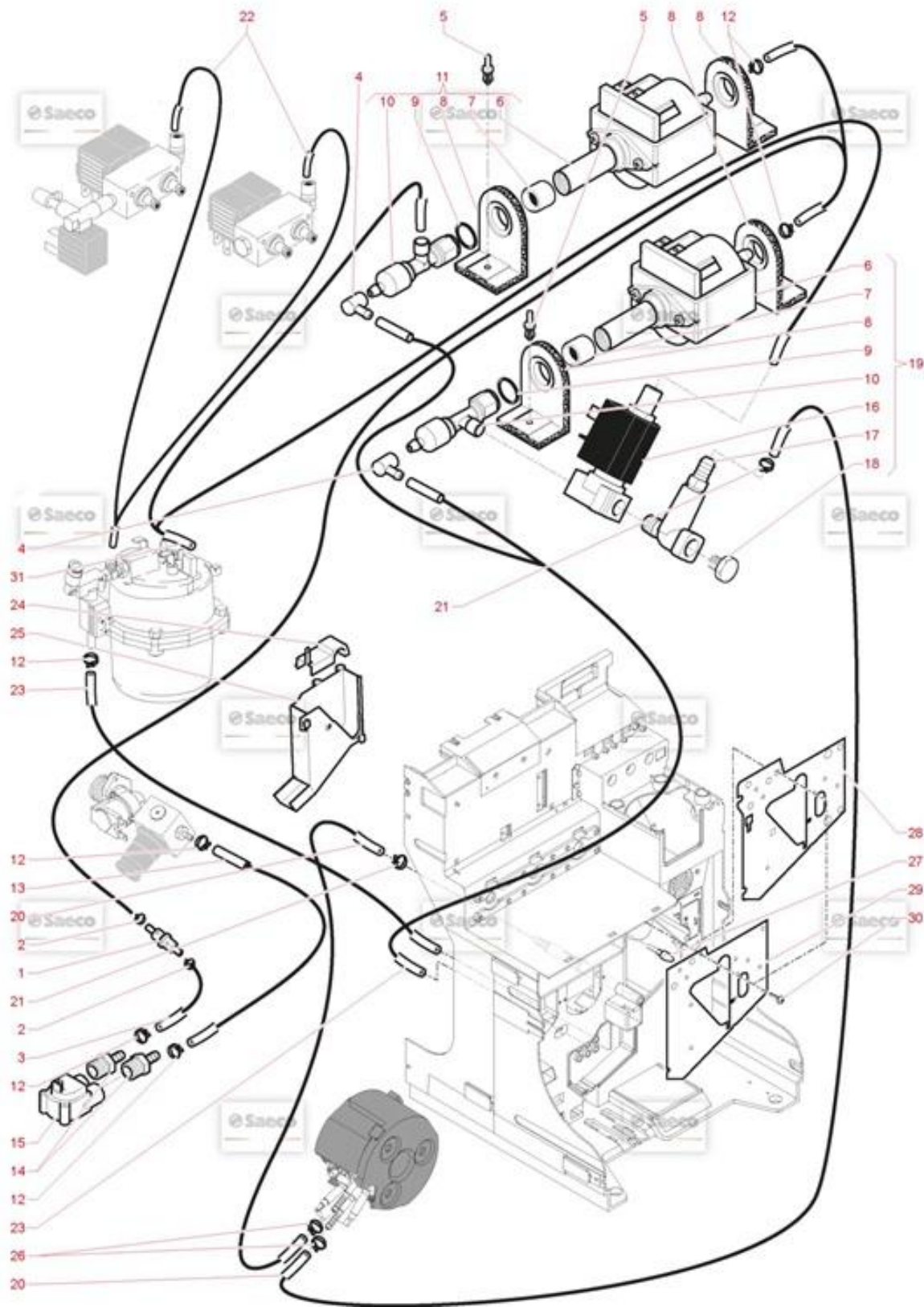























	41	 ПІД ЗАМОВЛЕННЯ	11012649	FRONTAL PANEL SP 5P07 <i>FRONTAL PANEL SP 5P07</i>
	42	 ПІД ЗАМОВЛЕННЯ	11031767	FRONTAL PANEL KEY PHEDRA SIL <i>FRONTAL PANEL KEY PHEDRA SIL</i>
	43		12001931	ЗАМОК 3355/11КА З ГАЙКОЮ <i>LOCK MERONI 3355/11KA+HARNESS</i>
	44	 ПІД ЗАМОВЛЕННЯ	20007220	KEY MERONI 3H1833CTCC- KA0514520X <i>KEY MERONI 3H1833CTCC- KA0514520X</i>
	45	 ПІД ЗАМОВЛЕННЯ	15004224	ADHESIVE LABEL <i>ADHESIVE LABEL</i>



Model Machine

MACSAE027













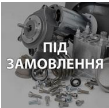













SAECO PHEDRA ESPRESSO

Web	Pos.	Foto	Item - Replace by	Description
				<i>Press - CTRL + CLICK go to item in a new window Натисніть - Ctrl + права кнопка миші щоб відкрити запчастину в новому вікні</i>
	1		11032038	FILTER INTAKE IN LUNG WATER SUPPLY <i>FILTRO POLMONE IN ASPIRAZ.RETE IDRICA</i>
	2		NV99.072	HOSE CLAMP D. 11.6/12.3 <i>HOSE CLAMP D. 11.6/12.3</i>
	3		9972.247	SILICONE TUBE 5X10 L.1400MM <i>TUBO SILICON.5X10 L=2000MM 60 SHORE</i>
	4		147920150	90° INLET PUMP CONNECTOR <i>RACCORDO A 90° IN SANTOPRENE</i>
	5		NF11.005	RIVET ITW D.5,5 <i>RIVETTO ITW D 5,5</i>
	6	 ПІД ЗАМОВЛЕННЯ	9070.034.00A	POMPE ULKA EP7 <i>POMPA ULKA EP7 230V</i>
	6	 ПІД ЗАМОВЛЕННЯ	9070.034.00F	ULKA PUMP EP7 120V <i>ULKA PUMP EP7 120V</i>
	6	 ПІД ЗАМОВЛЕННЯ	9070.034.00R	ULKA PUMP EP7 100V 50/60HZ <i>ULKA PUMP EP7 100V 50/60HZ</i>
	6		9070.042.00A	ULKA НАСОС (ПОМПА) EX5GW 230/240V 50HZ SD1 БЬЯНКО 15 BAR <i>ULKA PUMP EX5 SD1</i>
	6	 ПІД ЗАМОВЛЕННЯ	9070.042.00N	PUMP 220V <i>ULKA PUMP EX5 SD1</i>
	7		9071.098	REINFORCEMENT FOR ULKA PUMP <i>REINFORCEMENT FOR ULKA PUMP</i>
	8		149185850	ТРИМАЧ (ГУМОВИЙ)ПОМПИ ДЛЯ КАВОМАШИН SAECO MAGIC 4002012 (...) <i>SUPPORTO POMPA EATON MAGIC 4</i>
	9		140321961	ПРОКЛАДКА O-RING ДЛЯ КАВОМАШИНИ SAECO 2031 TERMOIL <i>OR 2031 IN TERMOIL</i>

Model Machine

MACSAE027























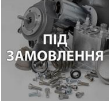

SAECO PHEDRA ESPRESSO

	10		11005590	SAFETY VALVE/NON RETURN ASS. NEW ASS.VALVOLA SICUREZZA/NON RI
	11		11025335	ASS.PUMP 220V/60HZ PHEDRA ASS.PUMP 220V/60HZ PHEDRA
	11		11025337	ASS.PUMP 230V 5P07 ASS.PUMP 230V 5P07
	11		11025340	ASS.PUMP 120V PHEDRA ASS.PUMP 120V PHEDRA
	11		11027123	PUMP EP7 T3X6 230V PHEDRA TTT PUMP EP7 T3X6 230V PHEDRA TTT
	12		NV99.077	ЗАЖИМНА СТЯЖКА D=9,8/10,6 1 .6 PHILIPS SAECO 996530069882 FASCETTA STRINGITUBO D=9,8/10,6
	13		9972.246	СИЛІКОНОВА ТРУБКА 5X10 SAECO 265918 (2 МЕТРИ) TUBO SILICONE 5X10 L.2000 MM
	14		11009215	RUBBER HOLDER FOR FILTER PORTAGOMMA RESCA STANDARD 1/4 RUBBER HOLDER FOR FILTER
	15		NV99.033	ПЛАСТИКОВА ТУРБИНА ВИСОКОГО ТИСКУ TURBINA DIGMESA IN PLASTICA
	16		11032651	ЕЛЕКТРОМАГНІТНИЙ КЛАПАН З ХОДОВИЙ N.C.2F/1M 1/8 18BAR D .1,1-1,7 EV 3 VIE N.C.2F/1M 1/8"18BAR D.1,1-1,7
	17		11008017	SAFETY VALVE 3,5 -4 BAR SAFETY VALVE ASS. 3,5 -4 BAR
	18		12001169	ЛАТУННА ЗАГЛУШКА BRASS CAP 1/8 GAS CONICAL TEA BRASS CAP 1/8 GAS CONICAL TEA
	19		11024994	PUMP 100V PHEDRA TTT CAPPUCCINO PUMP 100V PHEDRA TTT CAPPUCCINO
	19		11025336	ASS.PUMP 230V PHEDRA CAPPUCCINO ASS.PUMP 230V PHEDRA CAPPUCCINO

Model Machine

MACSAE027

SAECO PHEDRA ESPRESSO

	19		11030389	PUMP EP7 T3X6 230V PHEDRA TTTCAPP. <i>PUMP EP7 T3X6 230V PHEDRA TTTCAPP.</i>
	20		9972.202	SILICONE TUBE 5X10 L.320MM <i>SILICONE TUBE 5X10 L.320MM</i>
	21		NV99.087	BAND D=11/11,6 <i>BAND D=11/11,6</i>
	22		11025296	TEFLON TUBE 3X6 L.250 1/8"-1/8 <i>TEFLON TUBE 3X6 L.250 1/8-1/8</i>
	23		9972.057	КОРИЧНЕВА ГУМОВА ТРУБКА 5X8 2 МЕТРИ <i>TUBO SILICONE MARRON 5X8 L.2000 MM</i>
	24		9161.262.060	DRIP CHANNEL COVER <i>COPERTURA CANALINO RACCOGLIGOCCE</i>
	25		9111.597.050	COFFEE DISCHARGE CHANNEL SHORT <i>CANALINO SCARICO CAFFE' CORTO</i>
	26		NV99.036	HOSECLAMP D=8,5 09993.41.00 <i>HOSECLAMP D=8,5 09993.41.00</i>
	27		9011.005	PEG FOR BOILER <i>PERNO X CALDAIA</i>
	28		11013925	DRIP CANAL PLATE PHEDRA V2 <i>DRIP CANAL PLATE PHEDRA V2</i>
	29		11007017	DRIP CANAL PLATE 5P07 <i>DRIP CANAL PLATE 5P07</i>
	30		U142.008	PANELVIT TSP 3,5X12 DIN 7505 AGAL <i>PANELVIT TSP 3,5X12 DIN 7505 A GAL</i>
	31		11025342	TUBE ASS.TEFLON 4X6 L.400 1/8"-1/8 <i>TUBE ASS.TEFLON 4X6 L.400 1/8-1/8</i>

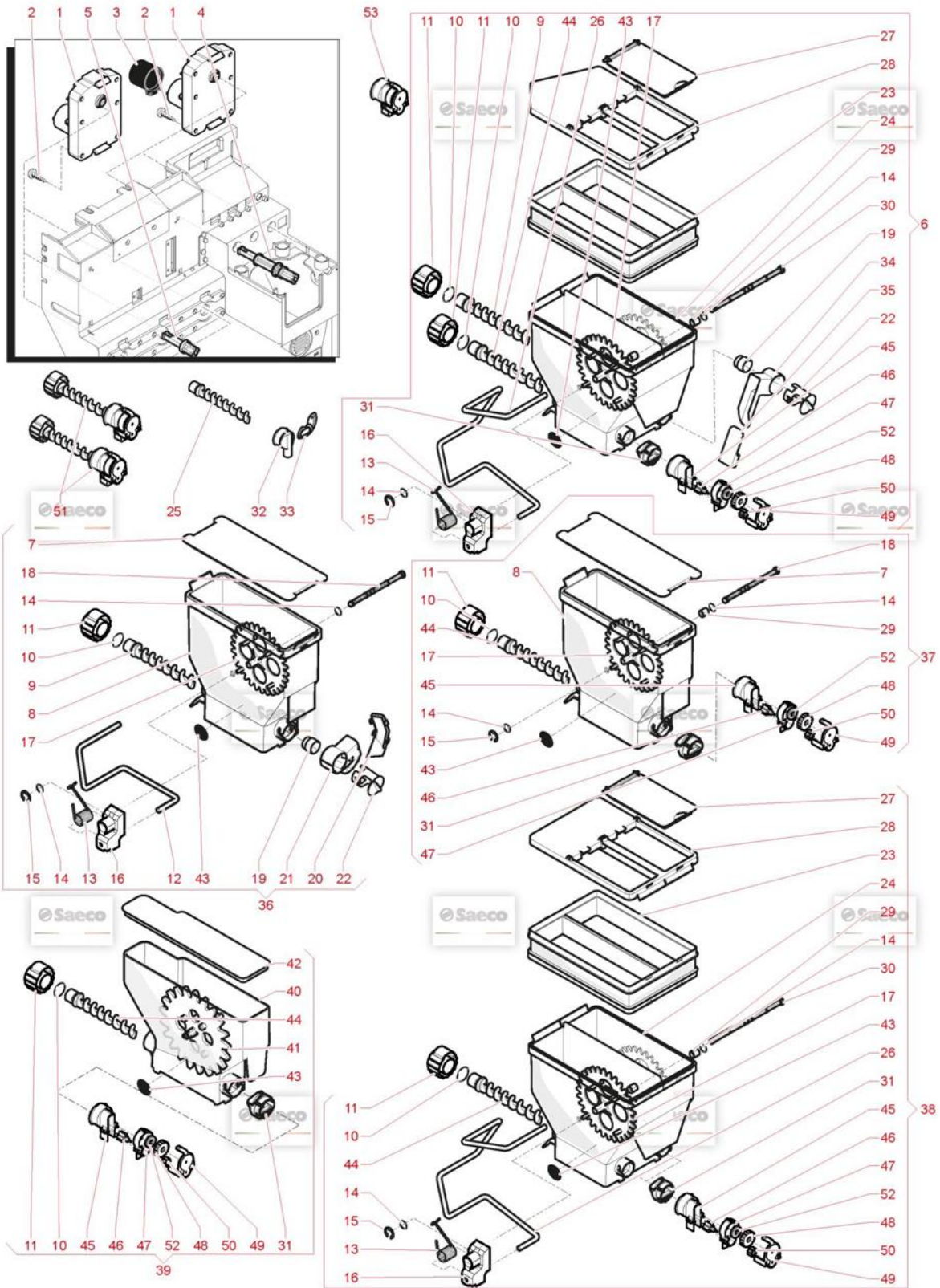

Model Machine

MACSAE027

SAECO PHEDRA ESPRESSO

Web Pos. Foto Item - Replace by Description



Press - CTRL + CLICK go to item in a new window

Натисніть - Ctrl + права кнопка миші щоб відкрити запчастину в новому вікні



1

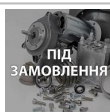

9121.216.00P

RATIOMOTOR 90 RPM 24V
MOTORIDUTTORE KENTA 90 RPM 2



2

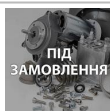

U109.002

NIK.SCREW TCB 3,5X25 DIN 7981C
NIK.SCREW TCB 3,5X25 DIN 7981 C



3



9121.155

HOOD FOR RATIOMOTOR
CUFFIA X MOTORIDUTTORE



4

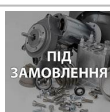

11011561

5P07 SINGLE INSTANT CONTAINERPIN
5P07 SINGLE INSTANT CONTAINER PIN



5



9111.586.050

PIN FOR MOTORS KENTA
PERNO X MOTORI KENTA



6



11031887

ASSEMBLED DOUBLE TANK
ASSEMBLED DOUBLE TANK



7



11007974

COVER CONTAINER SOLUBLE
COVER CONTAINER SOLUBLE



8



11001576

BASE CONTAINER SINGLE SOLUBLE
BASE CONTENITORE SOLUBILE SINGOLO



9



11001658

SCROLL SCREW
COCLEA PER DEVIATORE



10



NM03.013

OR 2,3X15 NBR
OR 2,3X15 NBR



11



11012130

BACK BUSH REINFORCE
BACK BUSH REINFORCE



12

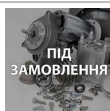

11007975

WIRE AGITATOR CHOCOLATE CONTAINER
WIRE AGITATOR CHOCOLATE CONTAINER



13































9111.731

SPRING
MOLLA AGITATORE

Model Machine

MACSAE027













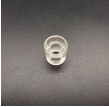











SAECO PHEDRA ESPRESSO

	14		NM03.022	OR ORM 0060-10 NBR OR ORM 0060-10 NBR
	15		U701.003	SNAP RING 7 UNI 7434 ANELLO ELASTICO 7 UNI 7434
	16		11007155	ПЛАСТИКОВИЙ ТРИМАЧ ВЗБИВАЛКИ SAECO 9111.735 AGITATOR SUPPORT
	17		9111.702	WHEEL DOUBLE CONTAINER RUOTA CONTENITORE DOPPIO
	18		11001580	PIN WHEEL CONTAINER SINGLE SOLUBLE PERNO RUOTA DENTATA CONT.SOLUB.SINGOLO
	19		11001654	BUSH CONTAINER BOCCOLA CONTENITORE
	20		11013386	COVER FOR SWITCH PHEDRA TTT COPERCHIO X DEVIATORE PHEDRA TTT
	21		11013385	SWITCH FOR PHEDRA TTT SWITCH FOR PHEDRA TTT
	22		9111.457.060	BUSH FOR LEFT/RIGHT DUCT COSMEC BOCCOLA X CONDOTTO DX-SX COSMEC
	23		11007016	40MM SOLUBLES CONTAINER PROLONG 40MM SOLUBLES CONTAINER PROLONG
	24		9111.680	BASE CONTAINER DOUBLE SOLUBLE BASE CONTENITORE SOLUBILI DOPPIO
	25		9111.701	SCROLL SCREW DOUBLE CONTAINER COCLEA CONTENITORE DOPPIO
	26		11006124	WIRE AGITATOR UNIFIED FILO AGITATORE UNIFICATO WIRE AGITATOR UNIFIED
	27		9111.683	SOLUBLE COVER COPERCHIETTO SOLUBILI

Model Machine

MACSAE027











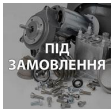

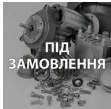

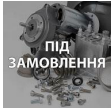



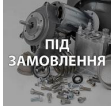





SAECO PHEDRA ESPRESSO

	28		9111.682	COVER CONTAINER DOUBLE SOLUBLE <i>COPERCHIO CONT.SOLUBILI DOPPIO</i>
	29		11032945	SPACE FOR GEAR BPA FREE <i>SPACE FOR GEAR BPA FREE</i>
	30		9111.703	DOUBLE PIN FOR WHEEL <i>PERNO DOPPIA PER RUOTA</i>
	31		11031844	ПЛАСТИКОВА КОРИЧНЕВА НАКЛАДКА НА БУНКЕР <i>BOCCOLA ANTERIORE MONO AGGANCIO NEW</i>
	32		9111.629.060	APERTURE FOR SOLUBLES HOPPER <i>APERTURE FOR SOLUBLES HOPPER</i>
	33		9111.338.270	BULKHEAD FOR APERT. CLOSURE ORANGE <i>PARATIA CHIUSURA BOCCHETTA ARANCIO</i>
	34		9111.425.060	POWDER DUCT <i>CONDOTTO POLVERE ORIENTABILE</i>
	35		9111.428.060	PLUG FOR LEFT-RIGHT DUCT <i>TAPPO X CONDOTTO DX-SX</i>
	36	 ПІД ЗАМОВЛЕННЯ	11013493	ASSEMBLY SOLUBLES CONTAINER PHEDRA TTT <i>ASSEMBLY SOLUBLES CONTAINER PHEDRA TTT</i>
	37		11031901	ASSEMBLED SINGLE TANK <i>ASSEMBLED SINGLE TANK</i>
	38	 ПІД ЗАМОВЛЕННЯ	11031900	ASSEMBLED DOUBLE TANK <i>ASSEMBLED DOUBLE TANK</i>
	39	 ПІД ЗАМОВЛЕННЯ	11031889	ASSEMBLY SINGLE CONTAINER <i>ASSEMBLY SINGLE CONTAINER</i>
	40	 ПІД ЗАМОВЛЕННЯ	11011559	5P07 INSTANT SMALL CONTAINER <i>5P07 INSTANT SMALL CONTAINER</i>

Model Machine

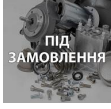
MACSAE027

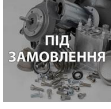
SAECO PHEDRA ESPRESSO

	41		11032879	CONTAINER WHEEL SUGAR CONTAINER WHEEL SUGAR
	42		11011560	COPERCHIO CONT. SMALL INSTANT5P07 COPERCHIO CONT. SMALL INSTANT 5P07
	43		9111.646	ADHESIVE FOR TANK ADHESIVE FOR TANK
	44		11005180	SCROLL SCREW FOR NEW DISPENSER APERTURE COCLEA X BOCCHETTA EROGAZIONE APERTURE SCROLL SCREW FOR ...
	45		11031678	EASY DRY DISPENSER APERTURE EASY DRY DISPENSER APERTURE
	46		11031679	DISPENSER FAN EASY DRY DISPENSER FAN EASY DRY
	47		11031691	CARTER FOR GEAR EASY DRY CARTER FOR GEAR EASY DRY
	48		11031690	WHEEL Z=18 EASY DRY WHEEL Z=18 EASY DRY
	49		11005168	LID CARTER GEAR LID CARTER GEAR
	50		11005182	WHEEL Z=9 WHEEL Z=9
	51		21001290	KIT NEW POWDER DISPENSING SYSTEM KIT NEW POWDER DISPENSING SYSTEM
	52		11031692	FELT RING DE=47,4 DI=41,4H=4 FELT RING DE=47,4 DI=41,4H=4
	53		21002190	НАБІР 3/4 ДО БУНКЕРУ АТЛАНТА SAECO 11005169 KIT EASY DRY

Model Machine

MACSAE027

SAECO PHEDRA ESPRESSO

MACSAE027.T.0006

TAVOLA NR. 6 - ARTICOLO SAECO PHEDRA ESPRESSO

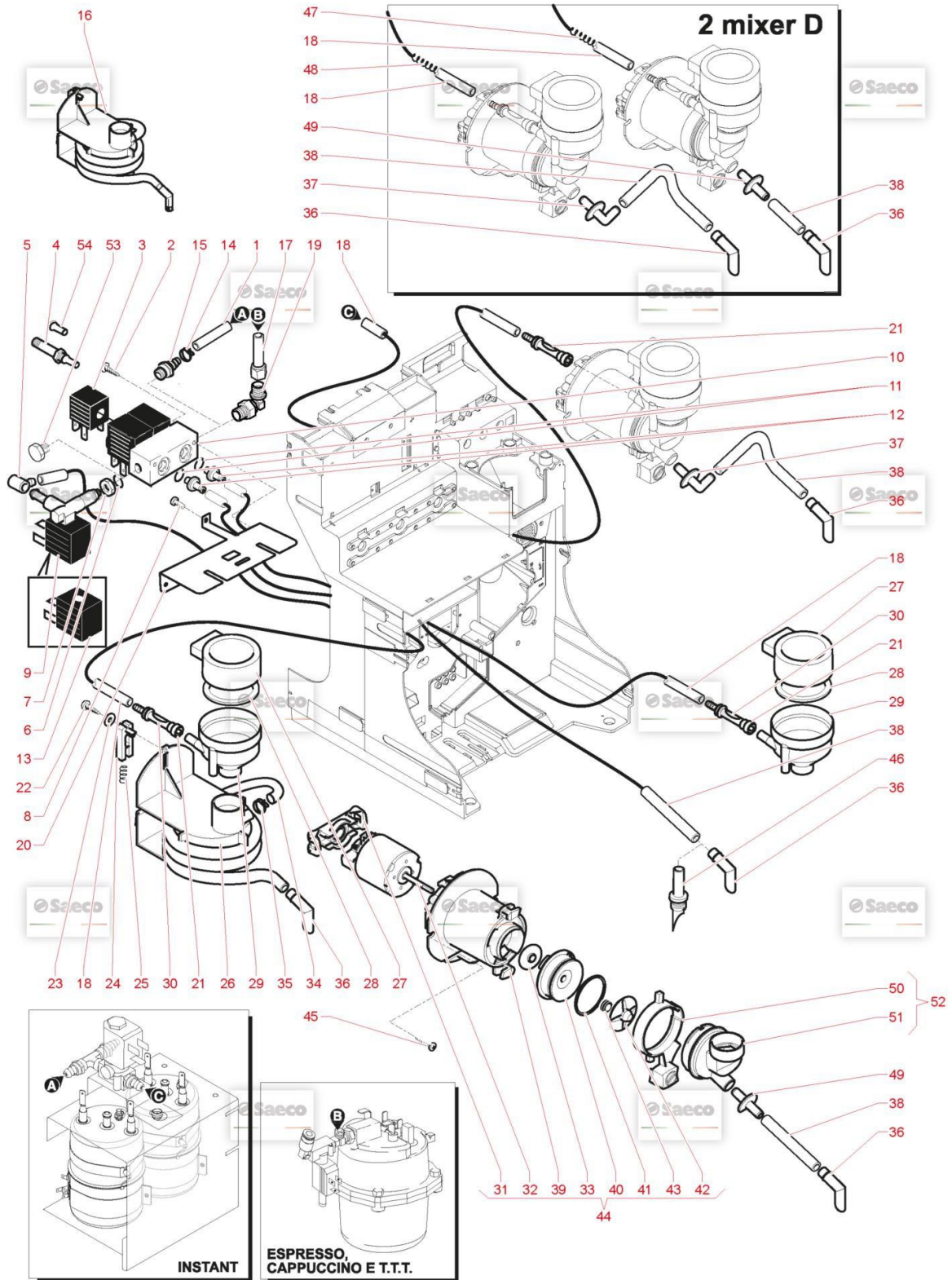

Model Machine

MACSAE027

SAECO PHEDRA ESPRESSO

Web Pos. Foto Item - Replace by Description



Press - CTRL + CLICK go to item in a new window

Натисніть - Ctrl + права кнопка миші щоб відкрити запчастину в новому вікні



1

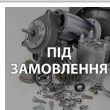

11001206

PINK 5X8,9 SILICONE TUBE L=200MM

PINK 5X8,9 SILICONE TUBE L=200 MM



1



9972.343

TUBO SILICONE TELATO 5X9 L=200MM

SILICONE TUBE FABRIC 5X9 L.95 MM



2



129516803

SCREW TCB3,5X19 DIN 7981 NICK

SCREW TCB3,5X19 DIN 7981 NICK



3



20005373

SOLENOID X HS1 11023762

SOLENOID X OLAB 24V DC 6000BH/BODN



4



20005374

ASS.NUCLEO FIS+MOB.X 11009225

ASS.NUCLEUS 6000BH/BODN X 11009225



5



147920150

90° INLET PUMP CONNECTOR

RACCORDO A 90° IN SANTOPRENE



6



140321462

O-RING 2018 SILICONE

OR 2018 IN SILICONE



7



9991.035

NUT 1/8 H 4.5

DADO 1/8 H.4,5



8



U143.022

SCREW T.M.T. K.F.R. 3,5X9,5 ZNP

VITE T.M.T. K.F.R. 3,5X9,5 ZNP



9



11027286

ELETTROVALVE 24V DC TEA

ELETTROVALVE 24V DC TEA



10



11026112

2 E/V 3 WAYS 5P07 BLOCK TEA

2 E/V 3 WAYS 5P07 BLOCK TEA EX.11007165



11



NM01.004

OR 2025 SILICONE

OR 2025 SILICONE



12



11011453











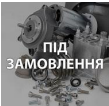















RUBBER HOLDER CONNECTOR TEA

RUBBER HOLDER CONNECTOR TEA

Model Machine

MACSAE027



























SAECO PHEDRA ESPRESSO

	13	 ПІД ЗАМОВЛЕННЯ	0862.R03	COIL FOR SOLENOID VALVE 2 WAY <i>COIL FOR SOLENOID VALVE 2 WAY</i>
	14		12000892	ЗАЖИМ D.9,5 16700004 <i>OETIKER CLAMP D=9,5 16700004 (L250)</i>
	14	 ПІД ЗАМОВЛЕННЯ	NV99.036	HOSECLAMP D=8,5 09993.41.00 <i>HOSECLAMP D=8,5 09993.41.00</i>
	15		11006304	TEA/BRASS CONNECTOR FOR ALUM.BOILER <i>TEA/BRASS CONNECTOR FOR ALUM.BOILER</i>
	15	 ПІД ЗАМОВЛЕННЯ	NR07.013	STD TOOTHED CONN. M 1/8X06 NICK. <i>STD TOOTHED CONN. M 1/8X06 NICK.</i>
	16		11008891	ASS.MIXER THE' 5P07 <i>ASS.MIXER THE' A SPIRALE 5P07</i>
	17		11025296	TEFLON TUBE 3X6 L.250 1/8"-1/8 <i>TEFLON TUBE 3X6 L.250 1/8-1/8</i>
	18		9972.247	SILICONE TUBE 5X10 L.1400MM <i>TUBO SILICON.5X10 L=2000MM 60 SHORE</i>
	19	 ПІД ЗАМОВЛЕННЯ	12001181	BICONICAL CONNECT. L M 1/8X06TEA <i>BICONICAL CONNECT. L M 1/8X06 TEA</i>
	20	 ПІД ЗАМОВЛЕННЯ	11022750	SOLENOID V. BLOCK SUPPORT PLATE <i>SOLENOID V. BLOCK SUPPORT PLATE</i>
	21	 ПІД ЗАМОВЛЕННЯ	11022846	ESPRESSO NOZZLE <i>ESPRESSO NOZZLE</i>
	22		U116.005	SCREW AUT.PT TCB 3,0X8 WN 1441 <i>VITE AUT.PT TCB 3,0X8 WN 1441 ZNP</i>
	23		U207.004	PLAIN WASHER 4,3X16 UNI 6592 GAL <i>PLAIN WASHER 4,3X16 UNI 6592 GAL</i>
	24		9111.209.060	CURSOR FOR SPIRAL MIXER FIXING <i>CURSOR FOR SPIRAL MIXER FIXING</i>

Model Machine

MACSAE027

























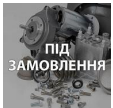

SAECO PHEDRA ESPRESSO

	25		9111.211	SPRING FOR MIXER CURSOR <i>MOLLA X CURSORE MISCELATORE</i>
	26		9111.643.060	RAPID FIXING MIXER <i>RAPID FIXING MIXER</i>
	27		9111.010.060	LID FOR FUNNEL BROWN <i>COPERCHIO X IMBUTO MARRON</i>
	28		9111.011.060	SEAL FOR FUNNEL BROWN <i>GUARNIZIONE X IMBUTO MARRON</i>
	29		9111.009.060	FUNNEL FOR POWDERS BROWN <i>IMBUTO X POLVERI MARRON</i>
	30		1863.A07	ESPRESSO NOZZLE <i>ASS.UGELLO ESPRESSO</i>
	31		9111.771.270	MOTOR COUPLING ORANGE RAL <i>MOTOR COUPLING ORANGE RAL</i>
	32		9121.248.00P	MOTOP MIKCEPA '05 24V DC - M.B.T. COD. 912124800 SAECO 9121.248.00 <i>MOTORE MIXER '05 24V DC - M.B.T.</i>
	33		9111.773.060	MOTOR PROTECTION RING <i>ANELLO PROTEZIONE MOTORE MIXER '05</i>
	34		9972.055	ТРУБКА СИЛІКОНОВА 8X12 2 МЕТРИ <i>SILICONE TUBE 8X12 L.2000MM</i>
	35		NV99.072	HOSE CLAMP D. 11.6/12.3 <i>HOSE CLAMP D. 11.6/12.3</i>
	36		1813.109.050	NOZZLES <i>NOZZLES</i>
	37		9111.164	CONNECTOR FOR MIXER <i>CONNECTOR FOR MIXER</i>

Model Machine

MACSAE027

SAECO PHEDRA ESPRESSO

	38		9972.057	КОРИЧНЕВА ГУМОВА ТРУБКА 5X8 2 МЕТРИ <i>TUBO SILICONE MARRON 5X8 L.2000 MM</i>
	39		9111.769.150	MIXER FLANGE <i>MIXER FLANGE</i>
	40		9111.770.060	COVER MIXER FLANGE <i>COVER MIXER FLANGE</i>
	41		NM03.012	OR ORM 0320-25 NBR <i>OR ORM 0320-25 NBR</i>
	42		9111.772.060	DISK FAN <i>VENTOLINA A DISCO MIXER '05</i>
	43		NM05.015	ПРОКЛАДКА V-RING 405 МІКСЕРА ДЛЯ КАВОМАШИН SAECO <i>V-RING MIXER '05</i>
	44		9110.160.06P	ДВИГУН МІКСЕРА ДЛЯ КАВОМАШИНИ SAECO 05 24V DC SAECO 9110.1... <i>ASS.MIXER '05 24V DC GROUP 500 SAECO</i>
	45		U109.003	SCREW TCB 3,5X9,5 DIN 7981 C NICK <i>SCREW TCB 3,5X9,5 DIN 7981 C NICK</i>
	46		9111.348	STRAIGHT DISPENSING NOZZLE <i>UGELLO EROGAZIONE DIR.</i>
	47		11013723	SPRING FOR TUBE L.35,5MM <i>SPRING FOR TUBE L.35,5MM</i>
	48		11013722	SPRING FOR TUBE L.85,5MM <i>SPRING FOR TUBE L.85,5MM</i>
	49		9111.232.060	STD TUBE HOLDER SLEEVE <i>MANICOTTO PORTATUBO STANDARD</i>
	49		9111.233.060	DECAFF.TUBE HOLDER SLEEVE <i>MANICOTTO PORTATUBO DECAFFEINATO</i>
	50		9111.230.270	MIXER LOCKING RING NUT ORANGERAL <i>GHIERA BLOCCAGGIO MIXER ARANCIO RAL</i>

Model Machine

MACSAE027

SAECO PHEDRA ESPRESSO

	51		9111.227.060	MIXER CASING <i>CORPO MIXER</i>
	52		9110.027.060	MIX CASING ASS. <i>ASS.CORPO MIX SAECO CRISTALLO,ATLANTE,QUARZO,RUBINO</i>
	53		12001169	ЛАТУННА ЗАГЛУШКА BRASS CAP 1/8 GAS CONICAL TEA <i>BRASS CAP 1/8 GAS CONICAL TEA</i>
	54		20007305	ЧАСТИНА ЕЛЕКТРОМАГНІТНОГО КЛАПАНА З ПОДВИЖНИМ СЕРДЕЧНИК... <i>SPARE EV MOBILE CORE 11023762</i>

Model Machine

MACSAE027

SAECO PHEDRA ESPRESSO

MACSAE027.T.0007



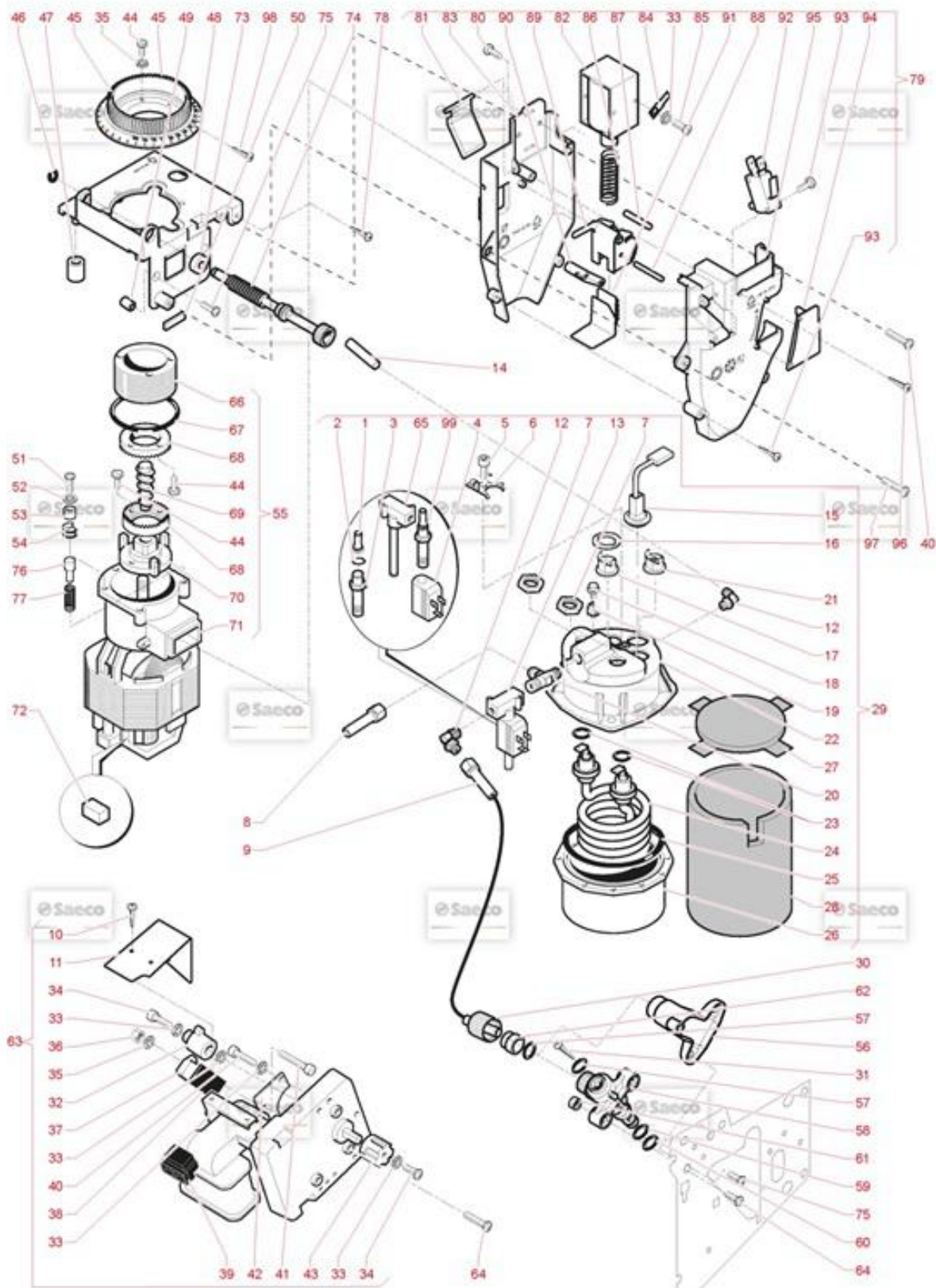























TAVOLA NR. 7 - ARTICOLO SAECO PHEDRA ESPRESSO



Model Machine

MACSAE027





























SAECO PHEDRA ESPRESSO

Web	Pos.	Foto	Item - Replace by	Description
				<i>Press - CTRL + CLICK go to item in a new window Натисніть - Ctrl + права кнопка миші щоб відкрити запчастину в новому вікні</i>
	1		0862.R16	ASS.NUCLEUS ASS.NUCLEO MOB.D.9 SPEC.MOLLA DURA
	1		20007305	ЧАСТИНА ЕЛЕКТРОМАГНІТНОГО КЛАПАНА З ПОДВИЖНИМ СЕРДЕЧНИК... SPARE EV MOBILE CORE 11023762
	1		20007362	SPARE CORE EV ODE RIC. NUCLEO EVT ODE
	2		0862.R17	ORM 0-100 10X1.5 NBR UP COIL ORM 0-100 10X1.5 NBR SOPRA BOBINA
	3		0862.R15	ASS.TUBE 3/2 WAYS ASS.CANNOTTO 3/2 VIE"E"OR.SUP.D.1.7
	3		20007306	SPARE EVT HS1 11023762 SPARE EVT HS1 11023762
	3		20007363	SPARE EVT ODE SPARE EVT ODE
	4		0862.R07	SOLENOID FOR MM VALVE 3 WAY 24V DC SOLENOID FOR MM VALVE 3 WAY 24V DC
	4		20005373	SOLENOID X HS1 11023762 SOLENOID X OLAB 24V DC 6000BH/BODN
	4		20007361	SOLENOID EVT ODE SOLENOID EVT ODE
	5		12001052	SCREW TCEI M4,0X6 DIN 912 ZIN SCREW TCEI M4,0X6 DIN 912 ZIN
	6		226830200	RETAIN.SPRING 3 THERM. +THERMAL FUSE RETAIN.SPRING 3 THERM. +THERMAL FUSE
	7		9991.029	NUT FOR RESISTOR DADO X RESISTENZA

Model Machine

MACSAE027





















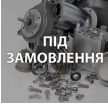



SAECO PHEDRA ESPRESSO

	8		11025296	TEFLON TUBE 3X6 L.250 1/8"-1/8 <i>TEFLON TUBE 3X6 L.250 1/8-1/8</i>
	9		11025406	TUBE ASSEMBLY TEFLON 3X6 L.250MM <i>TUBE ASSEMBLY TEFLON 3X6 L.250MM</i>
	10		129511903	SCREW TCB 2,9X6,4 DIN 7981 BZNICK <i>SCREW TCB 2,9X6,4 DIN 7981 BZ NICK</i>
	11	 ПІД ЗАМОВЛЕННЯ	11014251	CENTRAL UNIT MOTOR STEEL CARTER <i>CENTRAL UNIT MOTOR STEEL CARTER</i>
	12	 ПІД ЗАМОВЛЕННЯ	12001181	BICONICAL CONNECT. L M 1/8X06TEA <i>BICONICAL CONNECT. L M 1/8X06 TEA</i>
	13		11023762	ELECTROVALVE OLAB 3 WAYS 24V DC TEA <i>ELETTROVALVOLA OLAB 3 VIE 24V DC TEA</i>
	13		11032408	ЕЛЕКТРОМАГНІТНИЙ КЛАПАН 3 WAYS 24V <i>ELECTROVALVE ODE 3 WAYS 24V DC</i>
	14		11025342	TUBE ASS.TEFLON 4X6 L.400 1/8"-1/8" <i>TUBE ASS.TEFLON 4X6 L.400 1/8-1/8</i>
	15		11000316	ASSEMBLY HORIZONTAL SENSOR SG200 <i>ASSEMBLY HORIZONTAL SENSOR SG200</i>
	16		9991.085	THERMOSTAT FIXING WASHER <i>RONDELLA FERMATERMOSTATI</i>
	17		NE09.021	THERMOSTAT 150°NC FASTON 90° <i>TERMOSTATO 150°NC FASTON 90°</i>
	18		U023.020	SCREW TCEI M6X20 UNI 5931 ZIN <i>VITE TCEI M6X20 UNI 5931 8.8</i>
	19		NE15.031	MALE TONGUE PLAIN 6,3 D.6,3 <i>MALE TONGUE PLAIN 6,3 D.6,3</i>
	20		11011454	"T" CONNECTOR FOR BOILER TEA"" CONNECTOR FOR BOILER TEA <i>RACCORDO A T X CALDAIA TEA</i>

Model Machine

MACSAE027

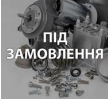













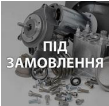











SAECO PHEDRA ESPRESSO

	21		189428700	THERMOSTAT 175° 1NT-15L-5126 <i>THERMOSTAT 175° 1NT-15L-5126</i>
	22		11002259	UPPER DOSER CASING M6 TEA <i>UPPER DOSER CASING M6 TEA</i>
	23		11000972	OR 3050 FKM 80 FD PEROXIDICA <i>OR 3050 FKM 80 FD PEROXIDICA</i>
	24		11007580	RES CALD. V230 W1000 INC.800 <i>RES CALD. V230 W1000 INC.800</i>
	24		11007593	RES CALD. V120 W1000 INC.800 <i>RES CALD. V120 W1000 INC.800</i>
	24		11007597	RES CALD. V100 W1000 INC.800 <i>RES CALD. V100 W1000 INC.800</i>
	25		NM04.010	OR ORM 0730-40 FPM 70+5 IRHDBLACK <i>OR ORM 0730-40 FPM 70 +5 IRHD NERO</i>
	26		9011.226	LOWER OVERSIZE CASING M6 VENDING <i>UPPER OVERSIZE CASING M6 VENDING</i>
	27		11030777	COFFEE BOILER 600CC UPPER ISOLATOR <i>COFFEE BOILER 600CC UPPER ISOLATOR</i>
	28		11030779	ІЗОЛЯЦІЯ НИЖНЬОЇ ЧАСТИНИ БОЙЛЕРА 600CC <i>COFFEE BOILER 600CC UPPER ISOLATOR</i>
	29		11024993	BOILER PHEDRA TTT CAPP.100V TEA <i>BOILER PHEDRA TTT CAPP.100V TEA</i>
	29		11032537	BOILER 230V <i>BOILER PHEDRA 230V</i>
	29		11032549	BOILER PHEDRA 120V TEA ODE CSA <i>BOILER PHEDRA 120V TEA ODE CSA</i>

Model Machine

MACSAE027

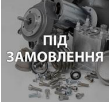











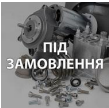













SAECO PHEDRA ESPRESSO

	30		11005743	KNURLED FEMALE HAND BOLT M14 GODRONE FEMMINA M14
	31		U109.037	SCREW AUT.TCB 4,8X13 DIN 7981C VITE AUT.TCB 4,8X13 DIN 7981 C NIK
	32		11003525	CAM COFFEE GROUP FRESH BREW CAM COFFEE GROUP FRESH BREW
	32		9991.037	CAM FOR RATIOMOTOR 1 MICRO CAMMA X MOTORIDUTTORE 1 MICRO
	33		128310404	МЕТАЛЕВЕ УБЧАСТЕ КОЛИЩАТКО UNI 8842 A4 WASHER UNI 8842 A4 BURNISHED
	34		129824002	TCB SCREW M4X10 UNI 7687 ZNP VITE TCB M4X10 UNI 7687 ZNP
	35		U208.002	TOOTHED WASHER 3,3X5,8 UNI 3703 G ROSETTA DENT. 3,3X5,8 UNI 3703 ZNP
	36		U302.002	NUT HEXAGONAL M3 UNI 5588 NUT HEXAGONAL M3 UNI 5588
	37		NE05.066	MICROSWITCH CHERRY D419Q1A МІКРОПЕРЕМІКАЧ РЕДУКТОРА РОБОЧОЇ ГРУПИ
	38		9991.014	CARD FOR MICRO SWITCHES CARTONCINO X MICROINTERRUTTORE
	39		11032817	RATIOMOTOR 30 PACK 230/240-50 RATIOMOTOR 30 PACK 230/240-50
	39		11032818	RATIOMOTOR 30 PACK 120/60 RATIOMOTOR 30 PACK 120/60
	39		11032819	RATIOMOTOR 30 PACK 220/60 MOTORIDUTT.IN PLASTICA PACCO 30 220/60
	39		11032830	RATIOMOTOR 30 PACK 100/50-60 RATIOMOTOR 30 PACK 100/50-60

Model Machine

MACSAE027



















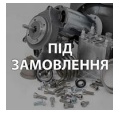

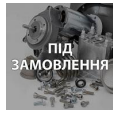

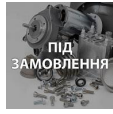

SAECO PHEDRA ESPRESSO

	40		129825502	TCB SCREW M4X25 UNI 7687 ZNP <i>TCB SCREW M4X25 UNI 7687 ZNP</i>
	41		U034.003	SCREW TCI M3,0X20 UNI 6107 GALV. <i>SCREW TCI M3,0X20 UNI 6107 GALV.</i>
	42		11003524	PLATE FOR MICRO RATIOMOTOR <i>PLATE FOR MICRO RATIOMOTOR</i>
	42		9991.015	PLATE FOR MICRO <i>PIASTRINA X MICRO</i>
	43		9991.013	JOINT FOR RATIOMOTOR <i>GIUNTO X MOTORIDUTTORE</i>
	44		U043.007	SCREW TCBC M3,0X8 UNI 7687 GALV. <i>SCREW TCBC M3,0X8 UNI 7687 GALV.</i>
	45		11027723	RING NUT OF GRIND REGULATION <i>RING NUT OF GRIND REGULATION</i>
	45		1813.103.A20	RING NUT OF GRIND REGULATION <i>RING NUT OF GRIND REGULATION</i>
	46		U701.011	STEEL SNAP RING 5 UNI 7434 <i>ANELLO ELASTICO 5 UNI 7434</i>
	47		1813.046.050	RUBBER GRIND SUPPORT <i>RUBBER GRIND SUPPORT</i>
	48		1813.045.A20	GRIND SUPPORT <i>GRIND SUPPORT</i>
	49		1813.097.A20	SPACER <i>SPACER</i>
	50		1813.177	SUPPORT SEAL <i>SUPPORT SEAL</i>
	51		12002052	ZN-B TCB SCREW M4X16 <i>ZN-B TCB SCREW M4X16</i>

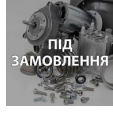
Model Machine

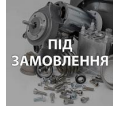
MACSAE027













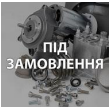

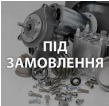











SAECO PHEDRA ESPRESSO

	52		U203.001	ШАЙБА 4,3X8 UNI 1749 GA PLAIN WASHER 4,3X8 UNI 1749 GAL
	53		9141.003	SPACER FOR RUBBER SPACER FOR RUBBER
	54		9991.005	RUBBER FOR COFFEE GRINDER GOMMINO X MACINA CAFFE
	55		11009741	ASS.MOTOR FOR COFFEE GRIND 220/230V 5P07 ASS.MOTOR FOR COFFEE GRIND 220/230V 5P07
	55		11013715	ASS.MOTOR FOR COFFEE GRIND 120V 5P07 ASS.MOTOR FOR COFFEE GRIND 120V 5P07
	55		11024998	ASS.MOTOR FOR COFFEE GRIND 100V PHEDRA ASS.MOTOR FOR COFFEE GRIND 100V PHEDRA
	56		11013431	PHEDRA TTT SLEEVE TTT CIRCUIT PHEDRA TTT SLEEVE TTT CIRCUIT
	57		140321462	O-RING 2018 SILICONE OR 2018 IN SILICONE
	58		11005370	PIN FOR MUFF PERNO X MANICOTTO PIN FOR MUFF
	59		11013173	OR ORM 0090-20 FKM 80 FD GREENPEROXIDA OR ORM 0090-20 FKM 80 FD GREEN PEROXIDA
	60		11013174	OR ORM 0050-20 FKM 80 FD GREENPEROXIDA OR ORM 0050-20 FKM 80 FD GREEN PEROXIDA
	61		U302.003	МЕТАЛЕВА ГАЙКА M4 UNI 5588 ZNP DADO ESAGONALE M4 UNI 5588 ZNP
	62		11005741	CONNECTOR D.6 BOCCOLA ESTERNA D.6

Model Machine

MACSAE027



























SAECO PHEDRA ESPRESSO

	63		11008960	RATIOMOTOR 230V 5P07 ASS.MOTORIDUTTORE 230V 5P07 RATIOMOTOR 230V 5P07
	63		11022071	RATIOMOTOR 220V/60HZ5P07 RATIOMOTOR 220V/60HZ5P07
	63		11023412	RATIOMOTOR PHEDRA TTT 120V CSA RATIOMOTOR PHEDRA TTT 120V CSA
	63		11024990	RATIOMOTOR PHEDRA TTT CAPP.100V RATIOMOTOR PHEDRA TTT CAPP.100V
	63		11027117	RATIOMOTOR PHEDRA TTT 230V RATIOMOTOR PHEDRA TTT 230V
	64		U044.013	SCREW TSPC M4,0X12 UNI 7688 GALV. VITE TSPC M4,0X12 UNI 7688 ZNP
	65		20007364	SPARE EVT 11032408 SPARE EVT 11032408
	66		9141.008	KNOB ADJUSTMENT SCREW KNOB ADJUSTMENT SCREW
	67		140321560	O-RING 3187 NBR OR 3187 IN NBR
	68		126520119	GRINDER FOR MOTOR TYPE BATTISTINI COPPIA DI MACINE PIANE DIAM 43
	69		9141.001	BRASS NCREMENT SCREW MC BRASS NCREMENT SCREW MC
	70		9141.007	МАЛЕНЬКИЙ АЛЮМІНІЄВИЙ ДИСК ТРИМАЧА НОЖІВ (АЛЮМІНІЙ) VENTOLINA
	71		9140.002.00A	MOTOR ASS.WITH CAP 230V ASS.MOTORE CON CALOTTA 230V
	71		9140.002.00F	MOTOR ASS.WITH CAP 120V MOTOR ASS.WITH CAP 120V

Model Machine

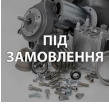
MACSAE027













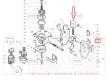











SAECO PHEDRA ESPRESSO

	72		0701.R34	МІДНО-ГРАФІТОВІ ЩІТКИ ДЛЯ КАВОМОЛКИ SAECO (1 ШТ) <i>SPAZZOLA X MOTORE MACINACAFFE'</i>
	73		1813.159	ANTIVIBRATION RUBBER <i>ANTIVIBRATION RUBBER</i>
	74		1813.104.A20	ADJUSTMENT SCREW WITH TUBE HOLDER <i>VITE REGOLAZIONE MACININO</i>
	75		U044.022	SCREW TSPC M5,0X8 UNI 7688 GALV. <i>SCREW TSPC M5,0X8 UNI 7688 GALV.</i>
	76		9141.005	KNOB PIN <i>PERNO MANOPOLA</i>
	77		126769118	SPRING FOR KNOB STOP PIN (H=19) <i>SPRING FOR KNOB STOP PIN (H=19)</i>
	78		U116.006	SCREW AUT.PT TCB 3,5X12 WN 1441 ZNP <i>VITE AUT.PT TCB 3,5X12 WN 1441 ZNP</i>
	79	 ПІД ЗАМОВЛЕННЯ	11024996	DOSER ASS. 6-11 GR. 100V <i>DOSER ASS. 6-11 GR. 100V</i>
	79	 ПІД ЗАМОВЛЕННЯ	1813.A10.A2A	DOSER ASS. 6-11 GR. <i>ASS.DOSATORE 6-11 GR.</i>
	79	 ПІД ЗАМОВЛЕННЯ	1813.A10.A2F	DOSER ASS. 6-11 GR.120V UL <i>DOSER ASS. 6-11 GR.120V UL</i>
	79	 ПІД ЗАМОВЛЕННЯ	1813.A10.A2N	DOSER ASS. 6-11 GR. 220V 60HZ <i>DOSER ASS. 6-11 GR. 220V 60HZ</i>
	80	 ПІД ЗАМОВЛЕННЯ	12002151	TSP SCREW M3X4 UNI 7688 SS <i>TSP SCREW M3X4 UNI 7688 SS</i>
	81	 <small>Liberty</small>	1813.042.A20	DISPENSER PALLET <i>DISPENSER PALLET</i>
	82		9121.235.00A	ELECTROMAGNET FOR DISPENSER WITH NUCLEUS <i>ELETTROM. PER DOSATORE CON NUCLEO</i>

Model Machine

MACSAE027

SAECO PHEDRA ESPRESSO

	82		9121.235.00F	ELECTROMAGNET X DISPENSER W/NUCLEUS 120V <i>ELECTROMAGNET X DISPENSER W/NUCLEUS 120V</i>
	82		9121.235.00N	ЕЛЕКТРОМАГНІТ ДЛЯ ДОЗАТОРА W/NUCLEUS 220V <i>ELECTROMAGNET X DISPENSER W/NUCLEUS 220V</i>
	83		1813.040.A20	DISPENSER SHELL <i>GUSCIO DOSATORE</i>
	84		NE15.003	MALE TONGUE PLAIN 6,3 D.5,2 <i>LINGUETTA MASCHIO PIANA 6,3 D.5,2</i>
	85		129821402	TCB SCREW M3X4 UNI 7687 ZNP <i>TCB SCREW M3X4 UNI 7687 ZNP</i>
	86		1813.127	SPRING FOR ELECTROMAGNET <i>MOLLA X ELETTROMAGNETE DOSAT</i>
	87		1813.092	PIN <i>PIN</i>
	88		1813.091	PIN FOR DISPENSER REGULATION <i>PIN FOR DISPENSER REGULATION</i>
	89		1813.043.A20	РЕГУЛЯТОР ДОЗАТОРА SAECO <i>REGOLATORE DOSATORE</i>
	90		1813.078.A20	ADJUSTMENT LEVER <i>ADJUSTMENT LEVER</i>
	91		1813.044.A20	PALLET FOR REGULATION <i>PALETTA X REGOLATORE</i>
	92		NE05.062	MICROSWITCH + WHEEL <i>MICROINTERRUTTORE C/ROTELLA</i>
	93		U116.004	SCREW AUT.PT TCB 3,0X16 WN 1441 <i>SCREW AUT.PT TCB 3,0X16 WN 1441</i>

Model Machine

MACSAE027

SAECO PHEDRA ESPRESSO



94



1813.191.A20

ПЛАСТИКОВА КРИШКА ДОЗАТОРА
COPERTURA DOSATORE



95



1813.041.A20

OUTSIDE SHELL DISPENSER
OUTSIDE SHELL DISPENSER



96

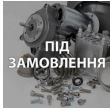

12000390

SCREW AUT.TCB 2,9X25 DIN 7981C NIK
SCREW AUT.TCB 2,9X25 DIN 7981 C NIK



97



12002039

SCREW TCBD TORX 20 M4X12 ZN-B
VITE TCBD TORX 20 M4X12 ZN-B



98



U109.004

SCREW AUT.TCB 4,8X9,5 DIN 7981C
VITE AUT.TCB 4,8X9,5 DIN 798



99

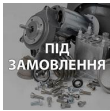

20007307



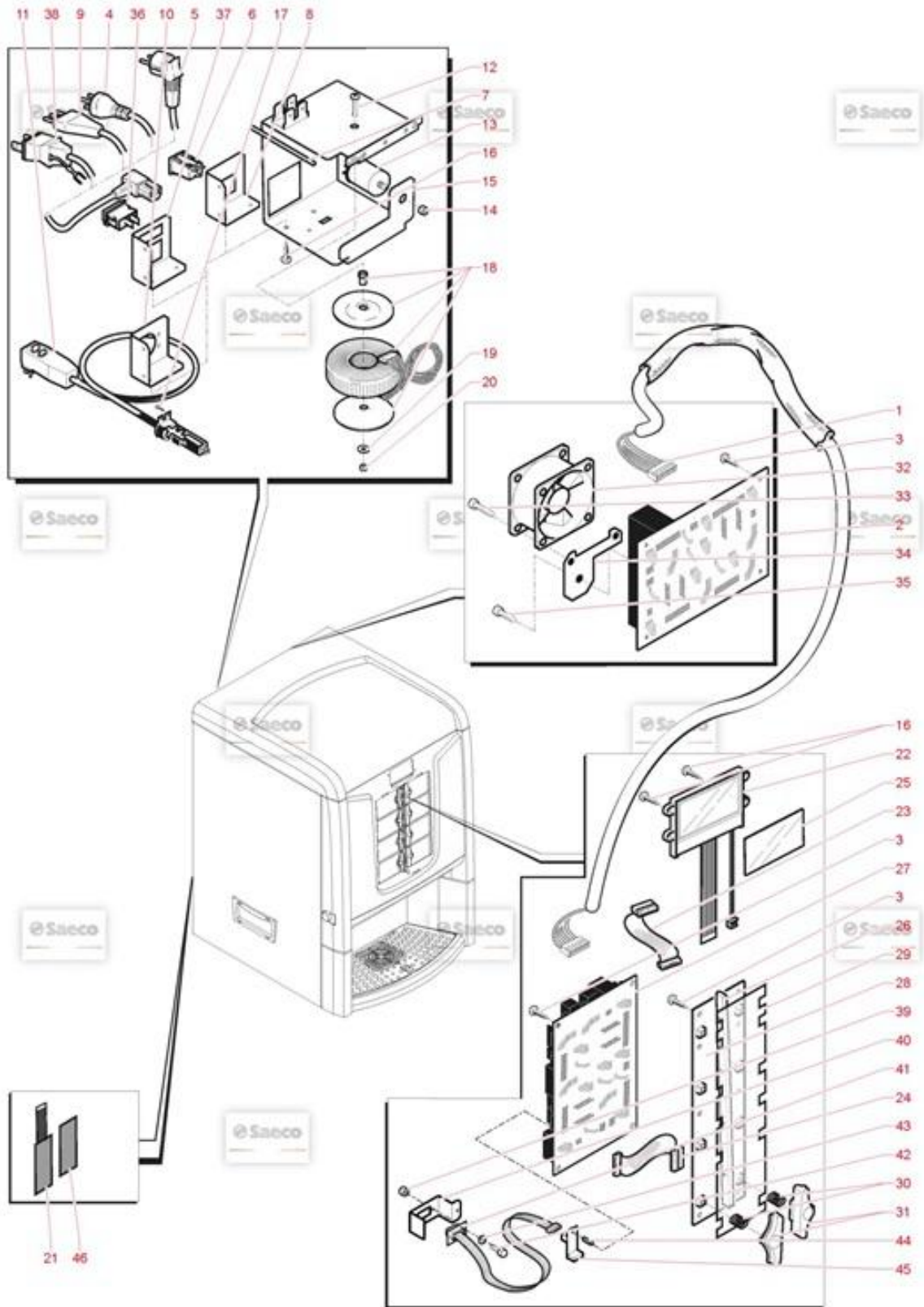

















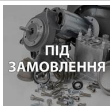

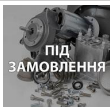



SPARE EVT HS1 11023762
SPARE EVT HS1 11023762

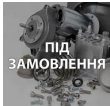

Model Machine

MACSAE027











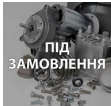

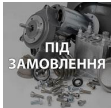

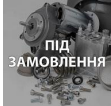

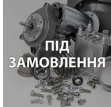

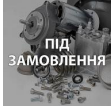

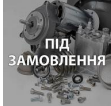

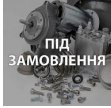

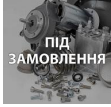

SAECO PHEDRA ESPRESSO

Web	Pos.	Foto	Item - Replace by	Description
				<i>Press - CTRL + CLICK go to item in a new window Натисніть - Ctrl + права кнопка миші щоб відкрити запчастину в новому вікні</i>
	1		11009349	26 POLES FLAT CABLE 5P07 <i>FLAT CABLE 26 POLI 5P07 26 POLES FLAT CABLE 5P07</i>
	2		11008068	DA5P-2007 PWR BOARD <i>DA5P-2007 PWR BOARD</i>
	2		20006510	SPARE PART POWER CARD PHEDRA <i>SPARE PART POWER CARD PHEDRA</i>
	3		U116.006	SCREW AUT.PT TCB 3,5X12 WN 1441 ZNP <i>VITE AUT.PT TCB 3,5X12 WN 1441 ZNP</i>
	4		NE01.053	CABLE AUSTRAL. +PLUG EN60320 C13 <i>CABLE AUSTRAL. +PLUG EN60320 C13</i>
	4		NE01.093	CABLE ARGENTINA + PLUG EN60320C13 <i>CABLE ARGENTINA + PLUG EN60320 C13</i>
	5		NE01.050	КАБЕЛЬ ЖИВЛЕННЯ ЧОРНИЙ SCHUKO L=1200***** EN60320 C13 <i>CAVO SCHUKO CON SPINA EN60320 C13</i>
	5		NE01.101	МЕРЕЖЕВИЙ КАБЕЛЬ 16A EN 60320 C19 <i>CABLE SCHUKO 16A EN 60320 C19</i>
	6		NE13.013	CUP SOCKET EN 60320 C 13 <i>CUP SOCKET EN 60320 C 13</i>
	6		NE13.055	CUP SOCKET 16A <i>CUP SOCKET 16A</i>
	7		11023545	PROFILE GES62F-A-C0 L.93 MM <i>PROFILE GES62F-A-C0 L.93 MM</i>
	8		11000546	POWER CONNECTOR SUPPORT <i>SQUADRETTA X PRESA VASCHETTA</i>
	8		11022784	PHEDRA INST 3KW PLUG SUPPORT PLATE <i>PHEDRA INST 3KW PLUG SUPPORT PLATE</i>

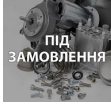
Model Machine

MACSAE027

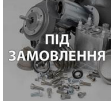

















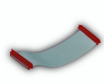



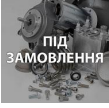

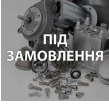
SAECO PHEDRA ESPRESSO

	9		17800019	BLACK POWER CABLE BRAZIL L=1200 <i>BLACK POWER CABLE BRAZIL L=1200</i>
	9		NE01.051	CABLE SWITZERLAND WITH PLUG EN603 <i>CABLE SWITZERLAND WITH PLUG EN603</i>
	10		11003906	USA CABLE SUPPORT ELECTRONIC PARTS BOX <i>USA CABLE SUPPORT ELECTRONIC PARTS BOX</i>
	11		11012009	POWER CABLE USA 3 POLE 15A X GFC8 <i>POWER CABLE USA 3 POLE 15A X GFC8</i>
	12		U005.021	SCREW TE M8,0X50 UNI 5739 ZNP <i>SCREW TE M8,0X50 UNI 5739 ZNP</i>
	13		11032135	LOCKING SCREW ANTIDISTURB FILTER 230V16A <i>LOCKING SCREW ANTIDISTURB FILTER 230V16A</i>
	14		U302.007	NUT HEXAGONAL M8 UNI 5588 <i>NUT HEXAGONAL M8 UNI 5588</i>
	15		11008417	ELECTRIC PARTS SUPPORT PLATE <i>ELECTRIC PARTS SUPPORT PLATE</i>
	16		U110.003	SCREW AUT.TCB 3,5X9,5 DIN 7981F <i>VITE AUT.TCB 3,5X9,5 DIN 798</i>
	17		U110.005	SCREW AUT.TCB 3,9X9,5 DIN 7981F <i>VITE AUT.TCB 3,9X9,5 DIN 798</i>
	18		11024297	TOROIDAL TRANSFORMER 5P07 <i>TOROIDAL TRANSFORMER 5P07</i>
	18		NE19.010	TOROIDAL TRANSFORMER 8P <i>TOROIDAL TRANSFORMER 8P</i>
	18		NE19.014	TOROIDAL TRANSFORMER 8P UL <i>TOROIDAL TRANSFORMER 8P UL</i>
	19		U208.009	TOOTHED WASHER 8,4X15 UNI 3703 <i>TOOTHED WASHER 8,4X15 UNI 3703</i>

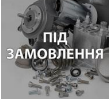
Model Machine

MACSAE027











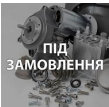



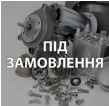











SAECO PHEDRA ESPRESSO

	20		U310.005	NUT SELF LOCK.M8 UNI 7473 <i>NUT SELF LOCK.M8 UNI 7473</i>
	21		0875.741	TOUCH PANEL <i>TOUCH PANEL</i>
	22		12000884	GRAPHIC DISPLAY OCS <i>GRAPHIC DISPLAY OCS</i>
	23		11009350	14 POLES FLAT CABLE KEYBOARD/CPU <i>14 POLES FLAT CABLE DISPLAY/CPU 5P07</i>
	24		11009487	FLAT CABLE 24 POLES DISPLAY <i>FLAT CABLE 24 POLES TOUCH/CPU</i>
	25		11007792	DISPLAY GLASS 5P07 <i>DISPLAY GLASS 5P07</i>
	26		11012441	PHEDRA LED BARREL <i>PHEDRA LED BARREL</i>
	26		11023960	PHEDRA WHITE LED BARREL <i>PHEDRA WHITE LED BARREL</i>
	27		11008979	CPU+SW AS.DA5P MY07 <i>CPU+SW AS.DA5P MY07</i>
	27		11014047	CPU+SW AS.PHEDRA HORECA <i>CPU+SW AS.PHEDRA HORECA</i>
	28		11008194	MECH.KEYBOARD DA5P-2007 <i>MECH.KEYBOARD DA5P-2007</i>
	29		11010937	PVC SHEET FOR 5P07 KEYBOARD <i>PVC SHEET FOR 5P07 KEYBOARD</i>
	30		0875.151	SPRING FOR SLIDING PLATE <i>MOLLA X PIASTR. SCORREVOLE</i>

Model Machine

MACSAE027

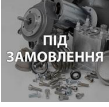
SAECO PHEDRA ESPRESSO

	31		11008352	PLASTIC BUTTON 5P07 <i>PLASTIC BUTTON 5P07</i>
	32		11025054	FAN 40X40X20 24V <i>FAN 40X40X20 24V</i>
	33		U109.002	NIK.SCREW TCB 3,5X25 DIN 7981C <i>NIK.SCREW TCB 3,5X25 DIN 7981 C</i>
	34		11024107	PHEDRA MAINBOARD COOLING FAN SUPP.PLATE <i>PHEDRA MAINBOARD COOLING FAN SUPP.PLATE</i>
	35		129511803	SCREW TCB 2,9X6,4 DIN 7981 NICK <i>SCREW TCB 2,9X6,4 DIN 7981 NICK</i>
	36		12000641	MOLVENO WATERPROOF GW ASSEMBLY SWITCH <i>MOLVENO WATERPROOF GW ASSEMBLY SWITCH</i>
	37		11025220	POWER CONNECTOR SUPPORT <i>POWER CONNECTOR SUPPORT</i>
	38		17800024	BLACK POWER CABLE JAPPON VCTFL=1200MM <i>BLACK POWER CABLE JAPPON VCTF L=1200MM</i>
	39		U302.002	NUT HEXAGONAL M3 UNI 5588 <i>NUT HEXAGONAL M3 UNI 5588</i>
	40		11001452	CLAMP SUPPORT CONNECTOR X FS400 <i>CLAMP SUPPORT CONNECTOR X FS400</i>
	41		2066.602	CAVO SERIALE RS 232 X EVA DTS <i>CAVO SERIALE RS 232 X EVA DTS</i>
	42		12000141	SPACE FOR KIT EVA DTS 304308040050 <i>SPACE FOR KIT EVA DTS HTSB-M3-05-2</i>
	43		128140521	WASHER 3,2X6 UNI 6592 SS <i>WASHER 3,2X6 UNI 6592 SS</i>
	44		12000147	SPACER RICHCO DLSP1-14M-01 <i>SPACER RICHCO DLSP1-14M-01</i>

Model Machine

MACSAE027

SAECO PHEDRA ESPRESSO



45

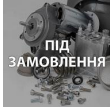

2066.601

TTL-RS232 ADAPTER BOARD

TTL-RS232 ADAPTER BOARD



46

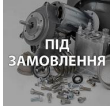

15004200

TOUCH PANEL PLATE

TOUCH PANEL PLATE

Model Machine

MACSAE027

SAECO PHEDRA ESPRESSO

MACSAE027.T.0009



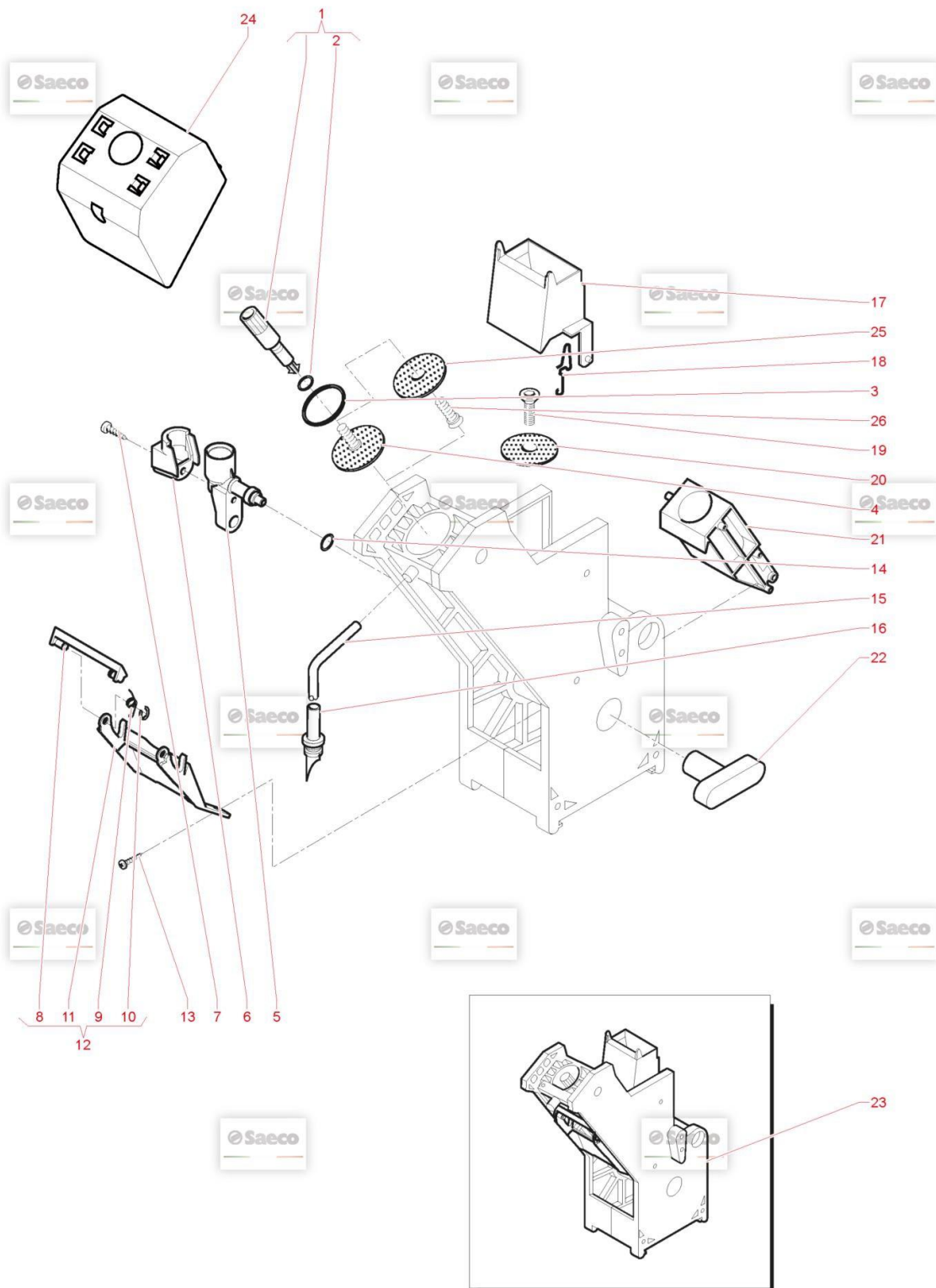























TAVOLA NR. 9 - ARTICOLO SAECO PHEDRA ESPRESSO



Model Machine

MACSAE027























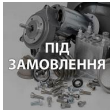

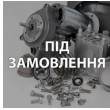

SAECO PHEDRA ESPRESSO

Web	Pos.	Foto	Item - Replace by	Description
				<i>Press - CTRL + CLICK go to item in a new window Натисніть - Ctrl + права кнопка миші щоб відкрити запчастину в новому вікні</i>
	1		9169.A14.060	ТРИМАЧ ФІЛЬТРА-СИТО РОБОЧОГО БЛОКУ КОРИЧНЕВИЙ КАВОМАШИН... <i>PIN FOR PERCOLATOR BROWN</i>
	2		NM02.006	OR R5 TERMOIL <i>OR R5 EPDM</i>
	3		140322061	O-RING 4112 EPDM <i>OR 4112 IN EPDM</i>
	4		324000100	SS PERCOLATOR D=34 SCREW FOR UNIT <i>SS PERCOLATOR D=34 SCREW FOR UNIT</i>
	5		11005371	UNIT COFFEE MUFF <i>MANICOTTO GRUPPO CAFFE' UNIT COFFEE MUFF</i>
	6		11010013	CARTER FOR MUFF PREHEATING UNIT <i>CARTE X MANICOTTO GRUPPO PRERISCALDO</i>
	7		129512921	SCREW TCB TORX 10 AB 2,9X13 SHEET SS <i>SCREW TCB TORX 10 2,9X13 SHEET SS</i>
	8		9111.537.060	BROWN SCRAPER COFFEE GROUP <i>BROWN SCRAPER COFFEE GROUP</i>
	9		9111.520	SPRING FOR SCRAPER SECTION 0.6 <i>SPRING FOR SCRAPER SECTION 0.6</i>
	10		U701.006	ФІКСУЮЧА СКОБА 3,2 (ЗАЛІЗО) SAECO <i>ANELLO ELASTICO 3,2</i>
	11		9111.539.060	FORK FOR SCRAPER <i>FORCELLA PER RASCHIATORE</i>
	12		9110.067.060	SCRAPER ASS.FOR CAPPUCCINAT. TUBE <i>ASS.RASCHIATORE X SG500/700</i>
	13		U110.013	БОЛТ МЕТАЛЕВИЙ 3,9X6,5 DIN 7981 F <i>SCREW AUT.TCB 3,9X6,5 DIN 7981 F</i>

Model Machine

MACSAE027

SAECO PHEDRA ESPRESSO

	14		140321462	O-RING 2018 SILICONE <i>OR 2018 IN SILICONE</i>
	15		9972.057	КОРИЧНЕВА ГУМОВА ТРУБКА 5X8 2 МЕТРИ <i>TUBO SILICONE MARRON 5X8 L.2000 MM</i>
	16		9111.348	STRAIGHT DISPENSING NOZZLE <i>UGELLO EROGAZIONE DIR.</i>
	17		322001201	MOBILE SCRAPER BROWN NARROW <i>MOBILE SCRAPER BROWN NARROW</i>
	18		9161.425	SPRING FOR SCRAPER <i>SPRING FOR SCRAPER</i>
	19		129851921	TSP SCREW M3X6 UNI 7688 SS <i>TSP SCREW M3X6 UNI 7688 SS</i>
	20		324000200	SS PERCOLATOR D=34 FOR UNIT <i>SS PERCOLATOR D=34 FOR UNIT</i>
	21		222711101	BROWN GROUND COFF.CONTAINER D=36 ASSY. <i>BROWN GROUND COFF.CONTAINER D=36 ASSY.</i>
	22		9161.021.060	KEY FOR BREW UNIT BROWN <i>CHIAVE X GRUPPO CAFFE' MARRO</i>
	23		11005421	BREW UNIT 7 GRAMS CRISTALLO600 <i>GRUPPO CAFFE' 7GR CRISTALLO600</i>
	23		11023330	ЗАВАРОЧНИЙ БЛОК (7GR) ДЛЯ КОФЕМАШИНИ PHILIPS SAECO <i>BREW UNIT 7 GRAMS CRISTALLO600</i>
	24		11013053	КРИШКА РОБОЧОЇ ГРУПИ <i>CARTER FOR DOSER UNIT</i>
	25		11012630	PERCOLATOR D.34 <i>PERCOLATOR D.34</i>
	26		129852821	TSP SCREW M3X14 UNI 7688 SS <i>TSP SCREW M3X14 UNI 7688 SS</i>

Model Machine

MACSAE027

SAECO PHEDRA ESPRESSO

MACSAE027.T.0010



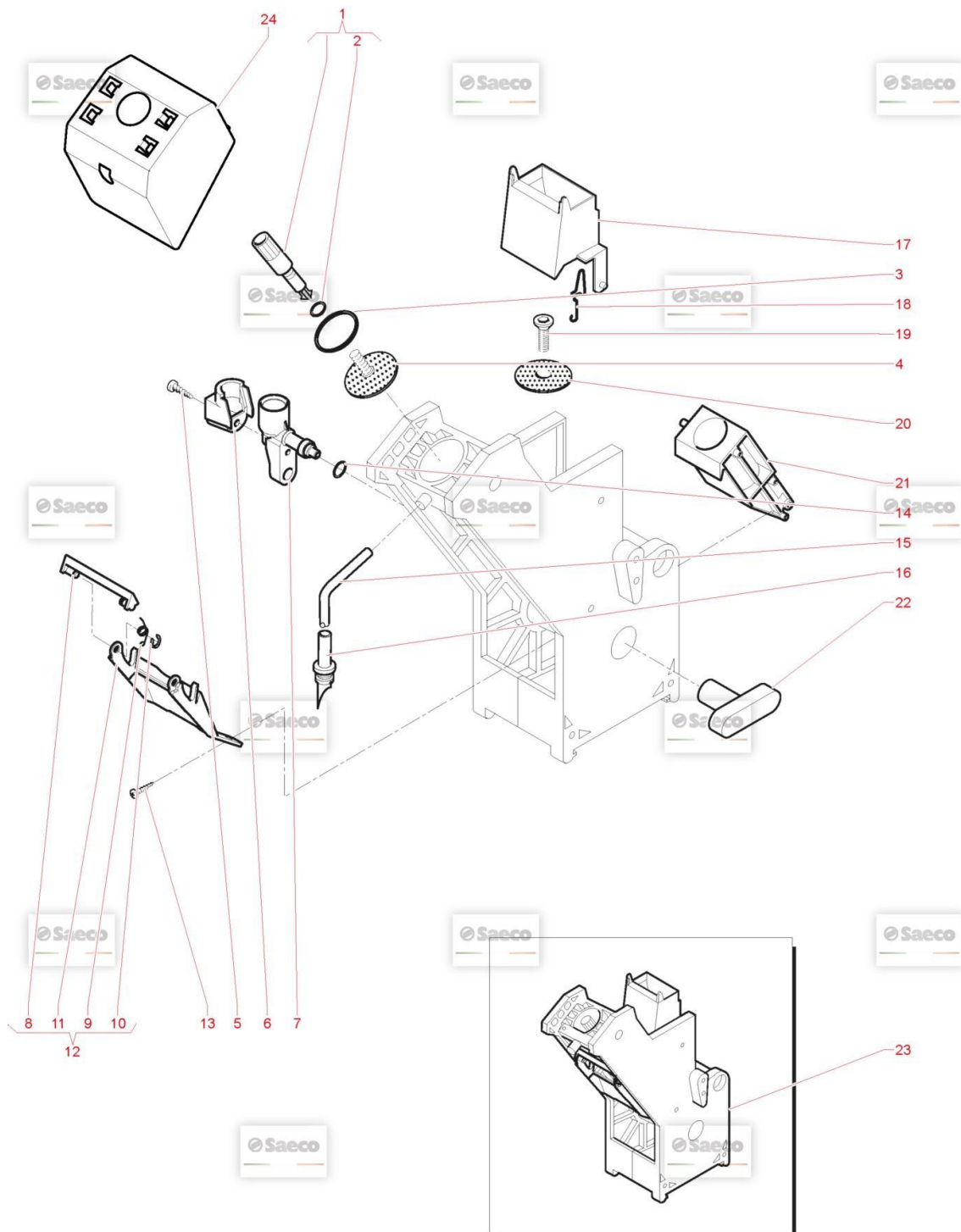























TAVOLA NR. 10 - ARTICOLO SAECO PHEDRA ESPRESSO



Model Machine

MACSAE027























SAECO PHEDRA ESPRESSO

Web	Pos.	Foto	Item - Replace by	Description
				<i>Press - CTRL + CLICK go to item in a new window Натисніть - Ctrl + права кнопка миші щоб відкрити запчастину в новому вікні</i>
	1		9169.A14.150	PIN FOR PERCOLATOR GREY ASS.PERNO X DOCCIA COMPLETO GRIGIO
	2		NM02.006	OR R5 TERMOIL OR R5 EPDM
	3		NM01.044	OR ORM 0320-40 SILICONE PTFE/FDA OR ORM 0320-40 SILICONE PTFE
	4		9161.036	UPPER PERCOLATOR FOR UNIT DOCCIA SUPERIORE X GRUPPO
	5		129512921	SCREW TCB TORX 10 AB 2,9X13 SHEET SS SCREW TCB TORX 10 2,9X13 SHEET SS
	6		11010013	CARTER FOR MUFF PREHEATING UNIT CARTE X MANICOTTO GRUPPO PRERISCALDO
	7		11005371	UNIT COFFEE MUFF MANICOTTO GRUPPO CAFFE' UNIT COFFEE MUFF
	8		9111.537.150	GREY SCRAPER COFFEE GROUP GREY SCRAPER COFFEE GROUP
	9		9111.520	SPRING FOR SCRAPER SECTION 0.6 SPRING FOR SCRAPER SECTION 0.6
	10		U701.006	ФІКСУЮЧА СКОБА 3,2 (ЗАЛІЗО) SAECO ANELLO ELASTICO 3,2
	11		9111.539.150	FORK FOR SCRAPER FORCELLA PER RASCHIATORE
	12		9110.067.150	SCRAPER ASS.FOR CAPPUCCINAT. TUBE ASS.RASCHIATORE X SG500/700
	13		U110.013	БОЛТ МЕТАЛЕВИЙ 3,9X6,5 DIN 7981 F SCREW AUT.TCB 3,9X6,5 DIN 7981 F

Model Machine

MACSAE027

SAECO PHEDRA ESPRESSO

	14		140321462	O-RING 2018 SILICONE <i>OR 2018 IN SILICONE</i>
	15		9972.057	КОРИЧНЕВА ГУМОВА ТРУБКА 5X8 2 МЕТРИ <i>TUBO SILICONE MARRON 5X8 L.2000 MM</i>
	16		9111.348	STRAIGHT DISPENSING NOZZLE <i>UGELLO EROGAZIONE DIR.</i>
	17		322001259	ПЛАСТИКОВА ВОРНОКА ПОДАЧІ КАВИ (ПЛАСТИК) ЧОРНИЙ <i>MOBILE SCRAPER GREY NARROW</i>
	18		9161.425	SPRING FOR SCRAPER <i>SPRING FOR SCRAPER</i>
	19		129851921	TSP SCREW M3X6 UNI 7688 SS <i>TSP SCREW M3X6 UNI 7688 SS</i>
	20		9161.037	НИЖНЄ СИТО БЛОКА ЗАВАРЮВАННЯ SAECO 9GR (ВЕНДІНГ) ДІАМ.38 <i>DOCCIA INFERIORE X GRUPPO</i>
	21		11002626	ASS. COFFEE CONTAINER GREY 9 GR. <i>ASS. COFFEE CONTAINER GREY 9 GR.</i>
	22		9161.021.060	KEY FOR BREW UNIT BROWN <i>CHIAVE X GRUPPO CAFFE' MARRO</i>
	23		11005422	ЗАВАРЮВАЛЬНИЙ БЛОК 9GR SAECO 996530002882 <i>GRUPPO CAFFE' 9GR CRISTALLO 600</i>
	24		11013053	КРИШКА РОБОЧОЇ ГРУПИ <i>CARTER FOR DOSER UNIT</i>

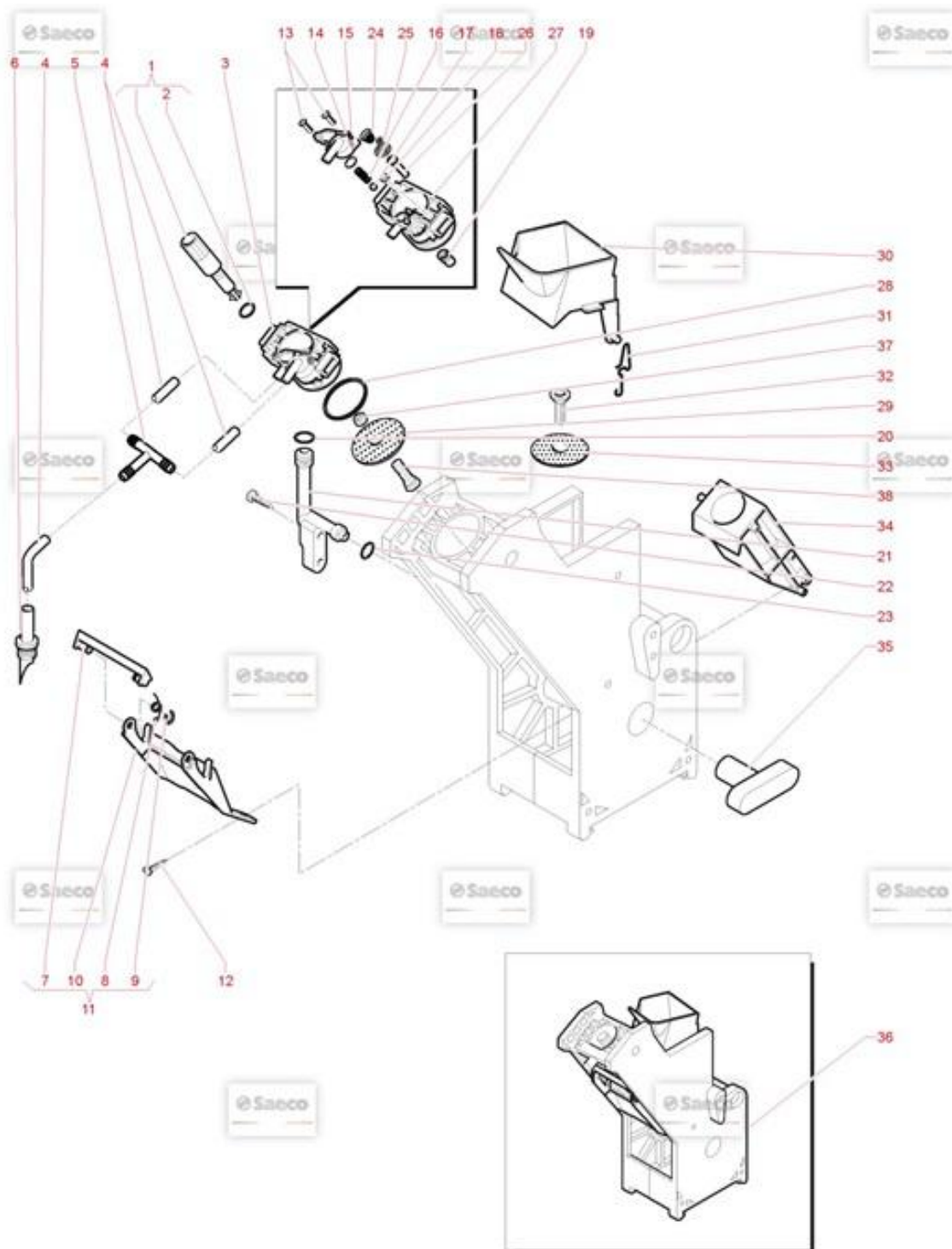

Model Machine

MACSAE027

SAECO PHEDRA ESPRESSO

Web Pos. Foto Item - Replace by Description



Press - CTRL + CLICK go to item in a new window
Натисніть - Ctrl + права кнопка миші щоб відкрити запчастину в новому вікні



1



9169.A14.150

PIN FOR PERCOLATOR GREY
ASS.PERNO X DOCCIA COMPLETO GRIGIO



2



NM02.006

OR R5 TERMOIL
OR R5 EPDM



3



11007343

НОСИК В ЗБОРІ 10 ГРАМ
ASS.COUNTERPISTON FRESH-BREW



4



9972.057

КОРИЧНЕВА ГУМОВА ТРУБКА 5X8 2 МЕТРИ
TUBO SILICONE MARRON 5X8 L.2000 MM



5

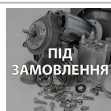

11007493

T CONNECTOR FOR BOILER P604
T CONNECTOR FOR BOILER P604



6



9111.348

STRAIGHT DISPENSING NOZZLE
UGELLO EROGAZIONE DIR.



7



9111.537.150

GREY SCRAPER COFFEE GROUP
GREY SCRAPER COFFEE GROUP



8



9111.520

SPRING FOR SCRAPER SECTION 0.6
SPRING FOR SCRAPER SECTION 0.6



9



U701.006

ФІКСУЮЧА СКОБА 3,2 (ЗАЛІЗО) SAECO
ANELLO ELASTICO 3,2



10



9111.539.150

FORK FOR SCRAPER
FORCELLA PER RASCHIATORE



11



9110.067.150

SCRAPER ASS.FOR CAPPUCCINAT. TUBE
ASS.RASCHIATORE X SG500/700



12



U110.013

БОЛТ МЕТАЛЕВИЙ 3,9X6,5 DIN 7981 F
SCREW AUT.TCB 3,9X6,5 DIN 7981 F



13

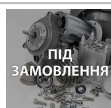













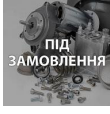







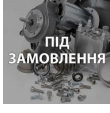



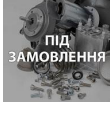

U109.030

САМОРІЗ AUT.TCB 2,9X16 DIN 7981 C
SCREW AUT.TCB 2,9X16 DIN 7981 C

Model Machine

MACSAE027





















SAECO PHEDRA ESPRESSO

	14		11003470	КРИШКА НОСИКА <i>LID X COUNTERPISTON FRESH-BREW</i>
	15		NM02.013	OR ORM 0080-15 TERMOIL <i>OR ORM 0080-15 TERMOIL</i>
	16		11028830	ПРУЖИНКА ДЛЯ FS400 ПІД ШАРИК ПОРШНЯ <i>SPRING FOR FS400 COVER CHASSIS</i>
	17		12001650	SPHERE TEFLON D.5 <i>SPHERE TEFLON D.5</i>
	18		U302.003	МЕТАЛЕВА ГАЙКА M4 UNI 5588 ZNP <i>DADO ESAGONALE M4 UNI 5588 ZNP</i>
	19		11003472	RUBBER X UNIT FRESH-BREW <i>RUBBER X UNIT FRESH-BREW</i>
	20		140320461	OR ORM 0080-20 TERMOIL <i>OR ORM 0080-20 IN TERMOIL</i>
	21		322000559	WATER FLOW PISTON GREY <i>WATER FLOW PISTON GREY</i>
	22		129512921	SCREW TCB TORX 10 AB 2,9X13 SHEET SS <i>SCREW TCB TORX 10 2,9X13 SHEET SS</i>
	23		140321462	O-RING 2018 SILICONE <i>OR 2018 IN SILICONE</i>
	24		11002603	SPING FOR MEMBRANE <i>SPING FOR MEMBRANE</i>
	25		11002625	MEMBRANE <i>MEMBRANE</i>
	26		11003471	PIN FOR MEMBRANE FRESH-BREW <i>PIN FOR MEMBRANE FRESH-BREW</i>
	27		11003469	COUNTERPISTON FRESH-BREW <i>COUNTERPISTON FRESH-BREW</i>

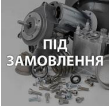
Model Machine

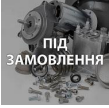
MACSAE027

SAECO PHEDRA ESPRESSO

	28		NM01.044	OR ORM 0320-40 SILICONE PTFE/FDA OR ORM 0320-40 SILICONE PTFE
	29		9161.167	СИТО МЕТАЛЛЕБЕ D=35,8 SAECO 11008362 PERCOLATOR D.35,8
	30		11003529	HOPPER DOSER UNIT FRESH BREW HOPPER DOSER UNIT FRESH BREW
	31		126836618	SPRING H=28 NEW FOR SCRAPER MOLLA H=28 NEW X RASCHIATORE
	32		129851921	TSP SCREW M3X6 UNI 7688 SS TSP SCREW M3X6 UNI 7688 SS
	33		9161.037	НИЖНЄ СИТО БЛОКА ЗАВАРЮВАННЯ SAECO 9GR (БЕНДІНГ) ДІАМ.38 DOCCIA INFERIORE X GRUPPO
	34		11002626	ASS. COFFEE CONTAINER GREY 9 GR. ASS. COFFEE CONTAINER GREY 9 GR.
	35		9161.021.150	KEY FOR BREW UNIT GREY KEY FOR BREW UNIT GREY
	36		11007283	BREW UNIT 10GRAMS FRESH BREW BREW UNIT 10GRAMS FRESH BREW
	37		U301.003	ГАЙКА HEXAGONAL M3 UNI 5587 NUT HEXAGONAL M3 UNI 5587
	38		129852821	TSP SCREW M3X14 UNI 7688 SS TSP SCREW M3X14 UNI 7688 SS

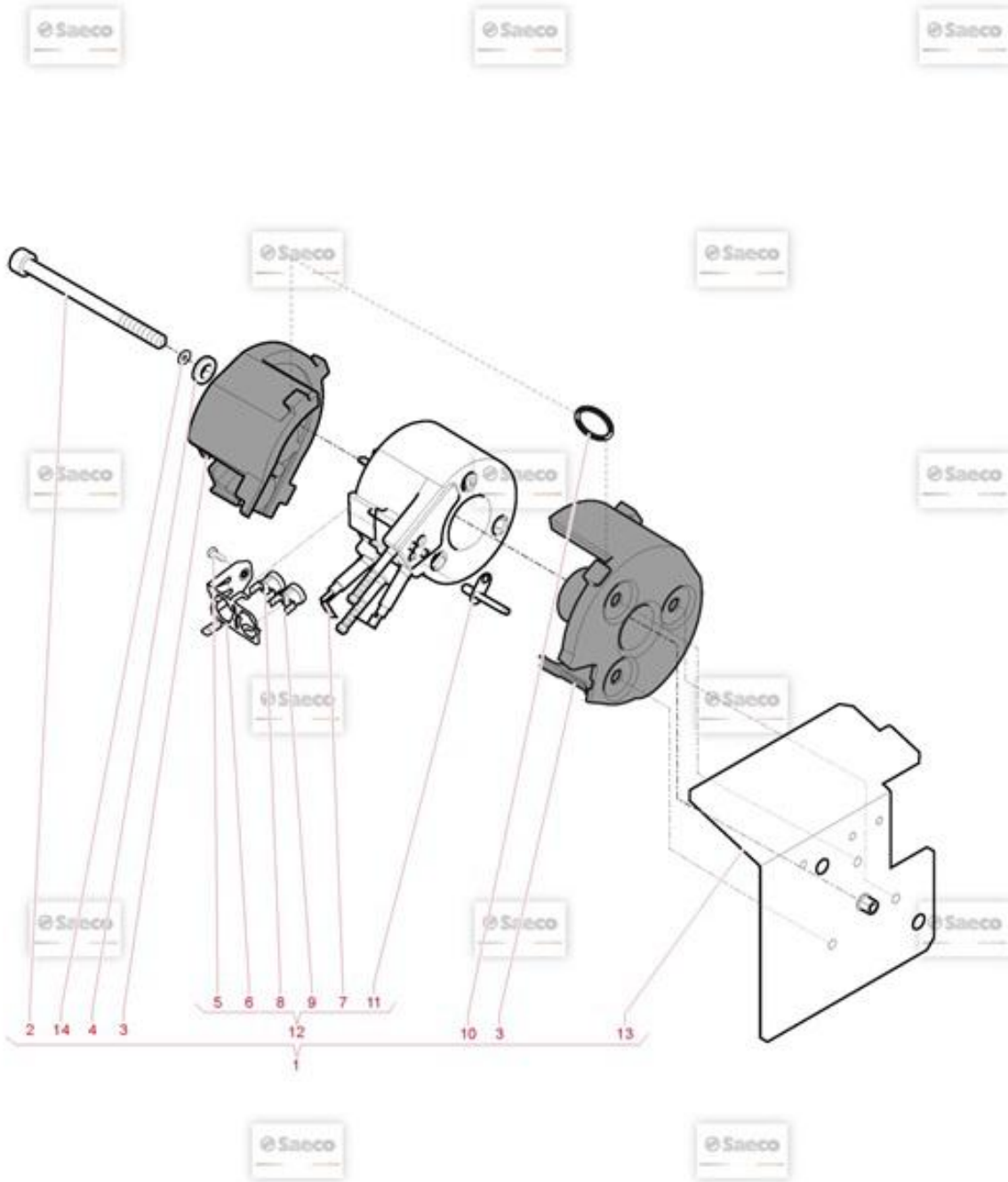

Model Machine

MACSAE027

SAECO PHEDRA ESPRESSO

Web Pos. Foto Item - Replace by Description



Press - CTRL + CLICK go to item in a new window

Натисніть - Ctrl + права кнопка миші щоб відкрити запчастину в новому вікні



1

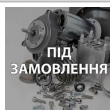

11013312

PHEDRA BOILERS SUPPORT PLATE
PHEDRA BOILERS SUPPORT PLATE



1

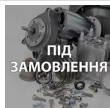

11024999

PHEDRA BOILERS SUPPORT PLATE 100V
PHEDRA BOILERS SUPPORT PLATE 100V



2

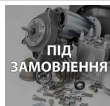

12001395

SCREW TCEI M5,0X65 UNI 5931 8.8 B
SCREW TCEI M5,0X65 UNI 5931 8.8 B



3

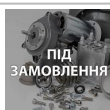

20007380

TERMOBLOCK HS3 FRONT/BACK COVER
TERMOBLOCK HS3 FRONT/BACK COVER



4

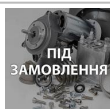

11013945

SPACER FASIT D.EXT.11 D.INT.5,5 #3
SPACER FASIT D.EXT.11 D.INT.5,5 #3



5



129573202

SCREW TCB TORX 20 M4X8 AUTOFORMING ZN-B
SCREW TAPT M4X8 UNI 8112



6

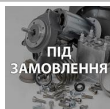

11007907

TUB.BOILER V5 SIDE THERMOS.FIXING SPRING
TUB.BOILER V5 SIDE THERMOS.FIXING SPRING



7

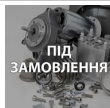

11011341

V4 TUB.BOILER 1300W 230V ASSY.
V4 TUB.BOILER 1300W 230V ASSY.



7

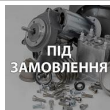

11011343

V4 TUB.BOILER 1300W 100V ASSY.
V4 TUB.BOILER 1300W 100V ASSY.



8

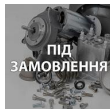

11005558

THERMOSTAT 190° NC FASTON 90°
THERMOSTAT 190° NC FASTON 90°



9



12000804

ТЕРМОСТАТ 190 1NT-08L-6067
THERMOSTAT 190° 1NT-08L-6067



10



NM03.013

OR 2,3X15 NBR
OR 2,3X15 NBR



11



11009589

ДАТЧИК ПАРИ SG650 SAECO
STEAM PROBE SG650

Model Machine

MACSAE027

SAECO PHEDRA ESPRESSO



12

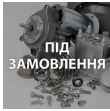

11013176

STEAM BOILER CAPP.230V 1300W

STEAM BOILER PHEDRA CAPP.230V 1300W



13

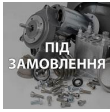

11013311

PHEDRA BOILERS SUPPORT PLATE

PHEDRA BOILERS SUPPORT PLATE



14



U207.001

PLAIN WASHER 5,3X10 UNI 6592 GAL

ROSETTA PIANA 5,3X10 UNI 6

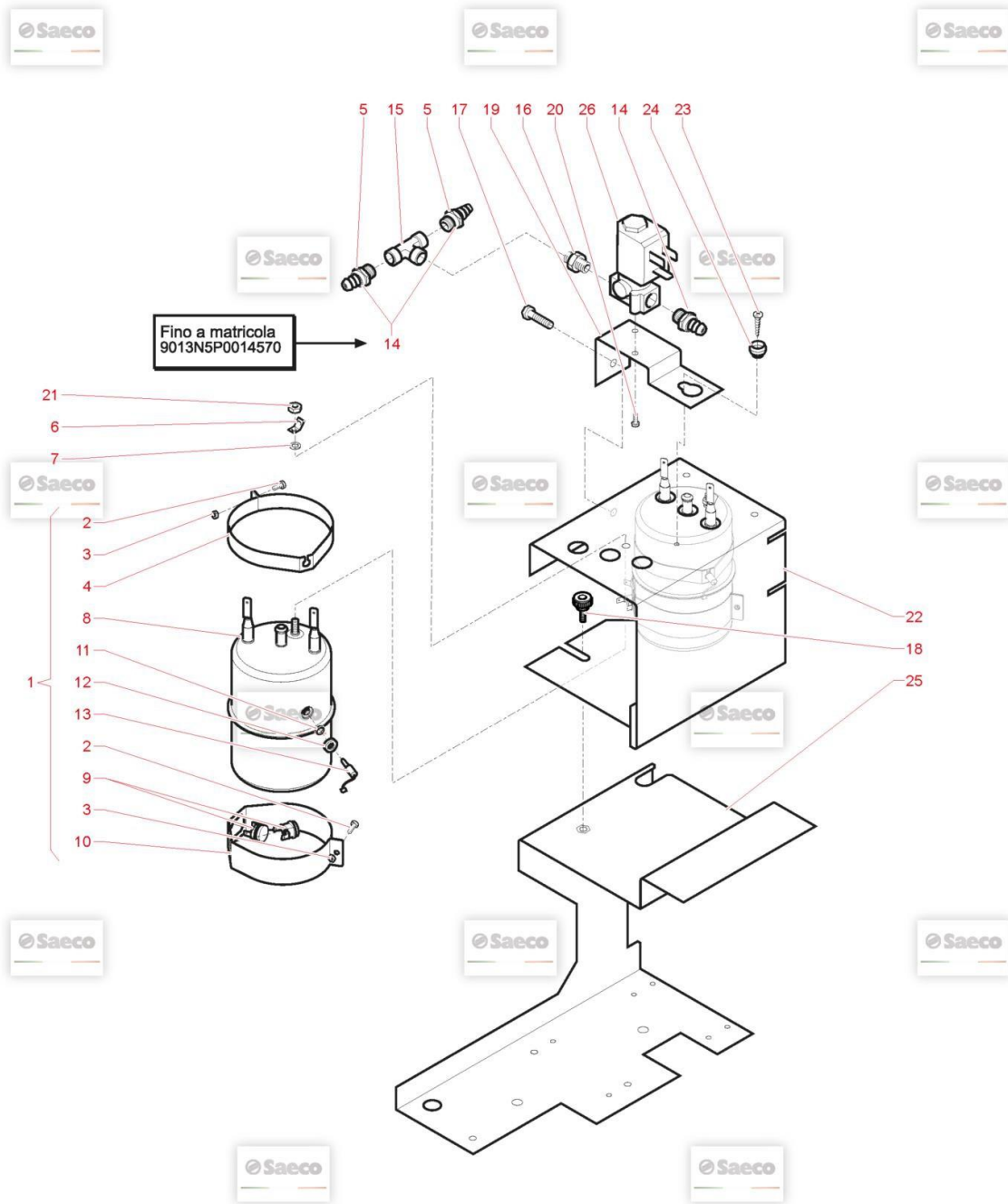

Model Machine

MACSAE027

SAECO PHEDRA ESPRESSO

Web Pos. Foto Item - Replace by Description



Press - CTRL + CLICK go to item in a new window











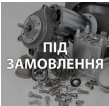

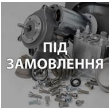













Натисніть - Ctrl + права кнопка миші щоб відкрити запчастину в новому вікні

	1		11032381	BOILER INOX 4BAR 230V 1400W <i>BOILER INOX 4BAR 230V 1400W PHEDRA INST.</i>
	1		20007322	KIT BOILER 230V+VALVE 3,5BAR <i>KIT CALD.INOX 230V+VALV.SIC.3.5BAR</i>
	1		21002161	KIT NEW BOILER PHEDRA INST <i>KIT NEW BOILER PHEDRA INST</i>
	2		U043.028	SCREW TCBC M3,0X10 UNI 7687 GALV. <i>SCREW TCBC M3,0X10 UNI 7687 GALV.</i>
	3		U310.001	МЕТАЛЕВА ГАЙКА M3 UNI 7473 ZNP <i>DADO AUTOBLOC M3 UNI 7473 ZNP</i>
	4		124321102	NTC STRIP LOCK <i>NTC STRIP LOCK</i>
	5		11006304	TEA/BRASS CONNECTOR FOR ALUM.BOILER <i>TEA/BRASS CONNECTOR FOR ALUM.BOILER</i>
	6		124390520	BRASS BENT FASTON 45° 6,3X0,8 <i>BRASS BENT FASTON 45° 6,3X0,8</i>
	7		128310421	WASHER UNI 8842 A4 SS <i>WASHER UNI 8842 A4 SS</i>
	8		11032362	BOILER INOX 4BAR 230V 1400W <i>BOILER INOX 4BAR 230V 1400W</i>
	8		20007323	KIT BOILER+VALVE 3,5 BAR PHEDRA INST. <i>KIT BOILER+VALVE 3,5 BAR PHEDRA INST.</i>
	9		NE09.010	ТЕРМОСТАТ 135□NC FAST. 90□ - ШАЙБА <i>THERMOSTAT 135□NC FAST. 90□ - WASHER</i>
	10		11008020	STRIP LOCK <i>STRIP LOCK</i>

Model Machine

MACSAE027

SAECO PHEDRA ESPRESSO

	11		145853660	SEAL TO HOLD BOILER SENSOR CIA002K <i>SEAL TO HOLD BOILER SENSOR CIA002K</i>
	12		121711020	BUSH FOR TO PRESS SEAL <i>BUSH FOR TO PRESS SEAL</i>
	13		11012424	SENSOR NTC BOILER ASS. <i>SENSOR NTC BOILER ASS.</i>
	14		NR07.013	STD TOOTHED CONN. M 1/8X06 NICK. <i>STD TOOTHED CONN. M 1/8X06 NICK.</i>
	15		NR07.044	STD. CONN. T FFF 1/8 NICK <i>STD. CONN. T FFF 1/8 NICK</i>
	16		12001180	STANDARD NIPPLO MM 1/8 X1/8 BRASS TEA <i>STANDARD NIPPLO MM 1/8 X1/8 BRASS TEA</i>
	17		U043.021	SCREW TCBC M5,0X8 UNI 7687 GALV. <i>VITE TCBC M5,0X8 UNI 7687 ZNP</i>
	18		12002031	KNOB D.18 M5X15 <i>KNOB D.18 M5X15</i>
	19		11013314	INSTANT 5P07 ELECTROVALV. SUPPORT PLATE <i>INSTANT 5P07 ELECTROVALV. SUPPORT PLATE</i>
	19		11030938	ELECTROVALVE SUPPORT <i>ELECTROVALVE SUPPORT</i>
	20		U043.007	SCREW TCBC M3,0X8 UNI 7687 GALV. <i>SCREW TCBC M3,0X8 UNI 7687 GALV.</i>
	21		U324.006	ШАЙБА M4 <i>NUT M4 FLANGED INDENTED BASE</i>
	22		11013313	INSTANT 5P07 BOILERS SUPPORT PLATE <i>INSTANT 5P07 BOILERS SUPPORT PLATE</i>
	22		11029078	UPPER SUPPORT PLATE BOILER PHEDRA INST. <i>UPPER SUPPORT PLATE BOILER PHEDRA INST.</i>

Model Machine

MACSAE027

SAECO PHEDRA ESPRESSO



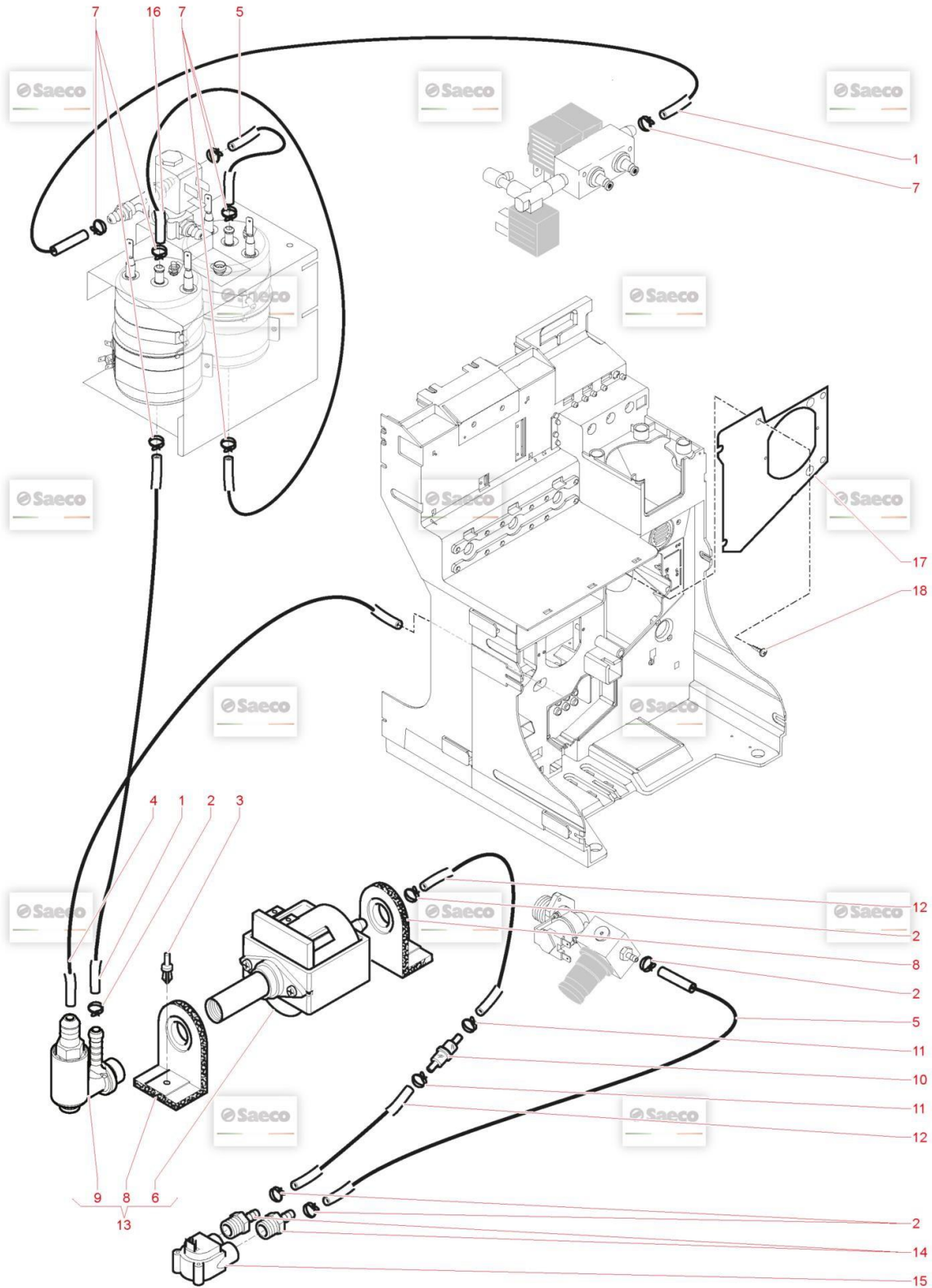









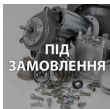

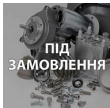

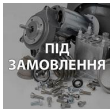





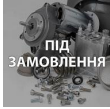

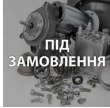

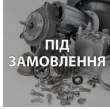
	23	 ПІД ЗАМОВЛЕННЯ	U110.002	SCREW AUT.TCB 3,5X13 DIN 7981F <i>SCREW AUT.TCB 3,5X13 DIN 7981 F</i>
	24	 ПІД ЗАМОВЛЕННЯ	11011054	PIN FOR BOSS D.8 <i>PIN FOR BOSS D.8</i>
	25	 ПІД ЗАМОВЛЕННЯ	11011579	INSTANT 5P07 BOILERS SUPPORT PLATE <i>INSTANT 5P07 BOILERS SUPPORT PLATE</i>
	26		12001230	КЛАПАН 24V. SG650 TEA <i>ELECTROVALVE 2 WAY 24 V SG 650 TEA</i>

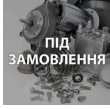

Model Machine

MACSAE027

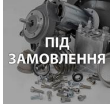















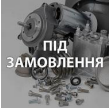

SAECO PHEDRA ESPRESSO

Web	Pos.	Foto	Item - Replace by	Description
				<i>Press - CTRL + CLICK go to item in a new window Натисніть - Ctrl + права кнопка миші щоб відкрити запчастину в новому вікні</i>
	1		11001206	PINK 5X8,9 SILICONE TUBE L=200MM <i>PINK 5X8,9 SILICONE TUBE L=200 MM</i>
	1		9972.343	TUBO SILICONE TELATO 5X9 L=200MM <i>SILICONE TUBE FABRIC 5X9 L.95 MM</i>
	2		NV99.087	BAND D=11/11,6 <i>BAND D=11/11,6</i>
	3		NF11.005	RIVET ITW D.5,5 <i>RIVETTO ITW D 5,5</i>
	4		9972.057	КОРИЧНЕВА ГУМОВА ТРУБКА 5X8 2 МЕТРИ <i>TUBO SILICONE MARRON 5X8 L.2000 MM</i>
	5		11005598	PINK 5X8,9 SILICONE TUBE L=160MM <i>PINK 5X8,9 SILICONE TUBE L=160 MM</i>
	5		9972.342	SILICONE TUBE FABRIC 5X9 L.160MM <i>SILICONE TUBE FABRIC 5X9 L.160MM</i>
	6		187721658	ULKA PUMP EP 8 230 VOLT <i>ULKA PUMP EP 8 230 VOLT</i>
	7		12000892	ЗАЖИМ D.9,5 16700004 <i>OETIKER CLAMP D=9,5 16700004 (L250)</i>
	7		NV99.036	HOSECLAMP D=8,5 09993.41.00 <i>HOSECLAMP D=8,5 09993.41.00</i>
	8		149185850	ТРИМАЧ (ГУМОВИЙ)ПОМПИ ДЛЯ КАВОМАШИН SAECO MAGIC 4002012 (...) <i>SUPPORTO POMPA EATON MAGIC 4</i>
	9		11032144	TEA/BRASS SAFETY VALVE 3:3,5 BAR <i>TEA/BRASS SAFETY VALVE 3:3,5 BAR</i>
	10		11024179	WATER FILTER PHEDRA <i>WATER FILTER PHEDRA</i>

Model Machine

MACSAE027

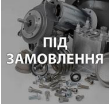
SAECO PHEDRA ESPRESSO



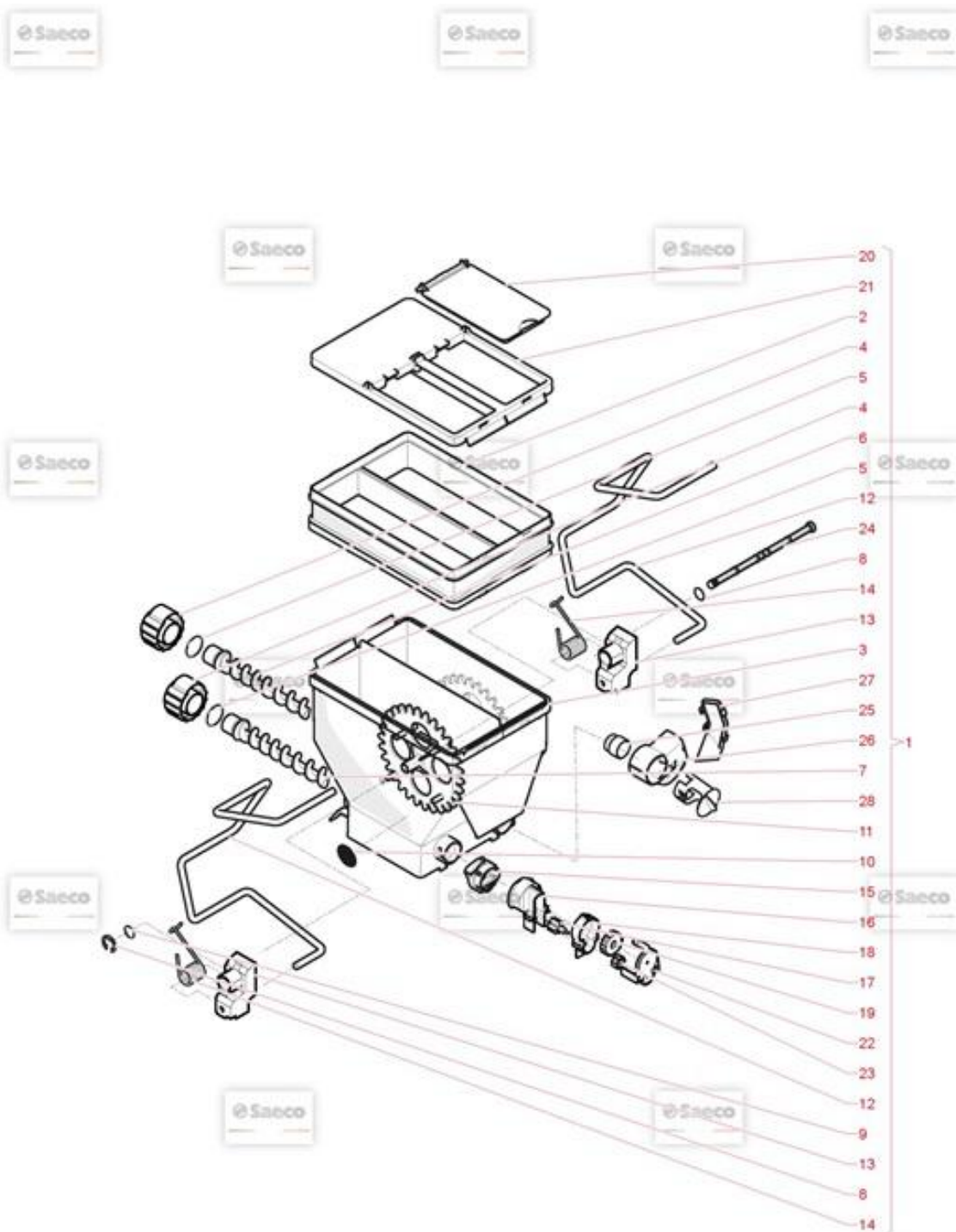









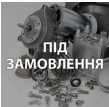













	11		NV99.072	HOSE CLAMP D. 11.6/12.3 <i>HOSE CLAMP D. 11.6/12.3</i>
	12		9972.247	SILICONE TUBE 5X10 L.1400MM <i>TUBO SILICON.5X10 L=2000MM 60 SHORE</i>
	13	 ПІД ЗАМОВЛЕННЯ	11014157	ASS.PUMP 230V PHEDRA INSTANT <i>ASS.PUMP 230V PHEDRA INSTANT</i>
	13	 ПІД ЗАМОВЛЕННЯ	11031448	NEW PUMP 230V PHEDRA INSTANT <i>NEW PUMP 230V PHEDRA INSTANT</i>
	14		11009215	RUBBER HOLDER FOR FILTER <i>PORTAGOMMA RESCA STANDARD 1/4 RUBBER HOLDER FOR FILTER</i>
	15	 ПІД ЗАМОВЛЕННЯ	12000880	TURBINA DIGMESA PREX PLASTICAD.3 <i>DIGMESA PLASTIC PREX TURBINE D.3</i>
	16	 ПІД ЗАМОВЛЕННЯ	11001208	PINK 5X8,9 SILICONE TUBE L=290MM <i>PINK 5X8,9 SILICONE TUBE L=290 MM</i>
	16	 ПІД ЗАМОВЛЕННЯ	9972.344	SILICONE TUBE 5X9 L.290 MM <i>SILICONE TUBE 5X9 L.290 MM</i>
	17	 ПІД ЗАМОВЛЕННЯ	11011578	INSTANT 5P07 3 MIXER SUPPORT PLATE <i>INSTANT 5P07 3 MIXER SUPPORT PLATE</i>
	18	 ПІД ЗАМОВЛЕННЯ	U142.008	PANELVIT TSP 3,5X12 DIN 7505 AGAL <i>PANELVIT TSP 3,5X12 DIN 7505 A GAL</i>



Model Machine

MACSAE027





























SAECO PHEDRA ESPRESSO

Web	Pos.	Foto	Item - Replace by	Description
				<i>Press - CTRL + CLICK go to item in a new window Натисніть - Ctrl + права кнопка миші щоб відкрити запчастину в новому вікні</i>
	1		11032470	PHEDRA TTT ASSEMBLED DOUBLE TANK <i>PHEDRA TTT ASSEMBLED DOUBLE TANK</i>
	2		11007016	40MM SOLUBLES CONTAINER PROLONG <i>40MM SOLUBLES CONTAINER PROLONG</i>
	3		9111.680	BASE CONTAINER DOUBLE SOLUBLE <i>BASE CONTENITORE SOLUBILI DOPPIO</i>
	4		11012130	BACK BUSH REINFORCE <i>BACK BUSH REINFORCE</i>
	5		NM03.013	OR 2,3X15 NBR <i>OR 2,3X15 NBR</i>
	6		11001658	SCROLL SCREW <i>COCLEA PER DEVIATORE</i>
	7		11005180	SCROLL SCREW FOR NEW DISPENSER APERTURE <i>COCLEA X BOCCHETTA EROGAZIONE APERTURE SCROLL SCREW FOR ...</i>
	8		NM03.022	OR ORM 0060-10 NBR <i>OR ORM 0060-10 NBR</i>
	9		U701.003	SNAP RING 7 UNI 7434 <i>ANELLO ELASTICO 7 UNI 7434</i>
	10		9111.646	ADHESIVE FOR TANK <i>ADHESIVE FOR TANK</i>
	11		9111.702	WHEEL DOUBLE CONTAINER <i>RUOTA CONTENITORE DOPPIO</i>
	12		11006124	WIRE AGITATOR UNIFIED <i>FILO AGITATORE UNIFICATO WIRE AGITATOR UNIFIED</i>
	13		11007155	ПЛАСТИКОВИЙ ТРИМАЧ ВЗБИВАЛКИ SAECO 9111.735 <i>AGITATOR SUPPORT</i>

Model Machine

MACSAE027

SAECO PHEDRA ESPRESSO

	14		9111.731	SPRING <i>MOLLA AGITATORE</i>
	15		11031844	ПЛАСТИКОВА КОРИЧНЕВА НАКЛАДКА НА БУНКЕР <i>BOCCOLA ANTERIORE MONO AGGANCIO NEW</i>
	16		11031678	EASY DRY DISPENSER APERTURE <i>EASY DRY DISPENSER APERTURE</i>
	17		11031679	DISPENSER FAN EASY DRY <i>DISPENSER FAN EASY DRY</i>
	18		11031691	CARTER FOR GEAR EASY DRY <i>CARTER FOR GEAR EASY DRY</i>
	19		11031690	WHEEL Z=18 EASY DRY <i>WHEEL Z=18 EASY DRY</i>
	20		9111.683	SOLUBLE COVER <i>COPERCHIETTO SOLUBILI</i>
	21		9111.682	COVER CONTAINER DOUBLE SOLUBLE <i>COPERCHIO CONT.SOLUBILI DOPPIO</i>
	22		11005168	LID CARTER GEAR <i>LID CARTER GEAR</i>
	23		11005182	WHEEL Z=9 <i>WHEEL Z=9</i>
	24		9111.703	DOUBLE PIN FOR WHEEL <i>PERNO DOPPIA PER RUOTA</i>
	25		11001654	BUSH CONTAINER <i>BOCCOLA CONTENITORE</i>
	26		11013385	SWITCH FOR PHEDRA TTT <i>SWITCH FOR PHEDRA TTT</i>
	27		11013386	COVER FOR SWITCH PHEDRA TTT <i>COPERCHIO X DEVIATORE PHEDRA TTT</i>

Model Machine

MACSAE027

SAECO PHEDRA ESPRESSO



28



9111.457.060

BUSH FOR LEFT/RIGHT DUCT COSMEC

BOCCOLA X CONDOTTO DX-SX COSMEC