

# Model Machine

MACNEC023

OASI 400-600

MACNEC023.T.0001

TAVOLA NR. 1 - ARTICOLO OASI 400-600

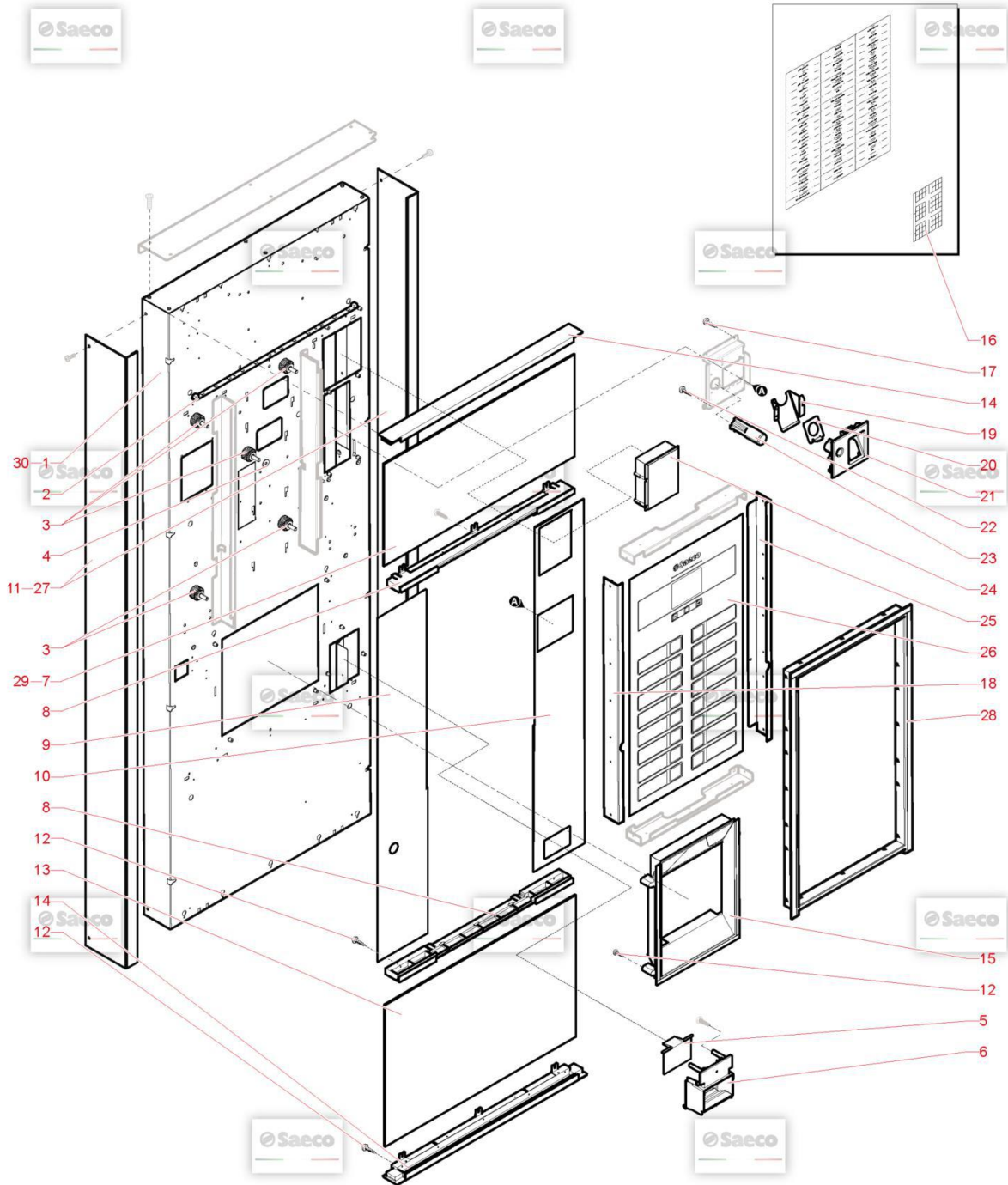

## Model Machine

MACNEC023

OASI 400-600

### Web Pos. Foto Item - Replace by Description



*Press - CTRL + CLICK go to item in a new window  
Натисніть - Ctrl + права кнопка миші щоб відкрити запчастину в новому вікні*



1

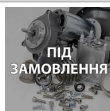

262379

DOOR STRUCTURE -400-  
DOOR STRUCTURE -400-



2

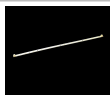

11031810

400MM LED BOARD  
400 MM LED BOARD



3

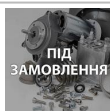

252384

KNOB M4X10  
MANOPOLA M4X10



4

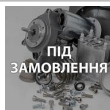

093999

COVERING FASTENING SCREW WASHER  
ROSETTA X VITE FISS.COP.



5

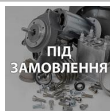

11032785

CHANGE DOOR FS4N  
SPORTELLO RENDIRESTO FS4N



6

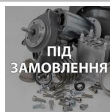

262405

COIN DOOR FRAME  
COIN DOOR FRAME



7



262402

TOP PHOTO PANEL  
TOP PHOTO PANEL



8

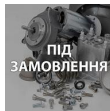

262397

CENTRAL PROFILE  
CENTRAL PROFILE



9

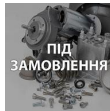

262404

LEFT SIDE SURROUND  
LEFT SIDE SURROUND



10

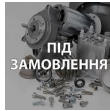

262403

RIGHT SIDE SURROUND  
RIGHT SIDE SURROUND



11

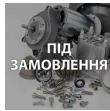

262527

EXTERNAL PROFILE -VERSION 600-  
EXTERNAL PROFILE -VERSION 600-



12

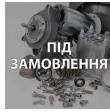











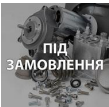

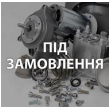

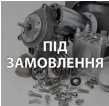











254432

3.5X15 SELF-TAPPING SCREW  
VITE AF 3.5X15

## Model Machine

MACNEC023

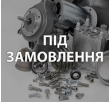





OASI 400-600

	13		<b>262401</b>	BOTTO PHOTO PANEL <i>PANNELLO FOTOGRAFICO INFERIORE</i>
	14		<b>262400</b>	TOP/BOTTOM PROFILE <i>TOP/BOTTOM PROFILE</i>
	15		<b>262396</b>	DISPENSING COMPARTMENT FRAME <i>DISPENSING COMPARTMENT FRAME</i>
	16		<b>0775.989</b>	PRICE LABELS WHITE EURO <i>PRICE LABELS WHITE EURO</i>
	17		<b>987612</b>	EJOT-PT-SCREW 4X12 <i>EJOT-PT-SCREW 4X12</i>
	18		<b>11032978</b>	LEFT TRACK FOR LEXAN FS4N <i>LEFT TRACK FOR LEXAN FS4N</i>
	19		<b>257325</b>	CLIP FOR COIN CHUTE <i>FERMO INTRODUZIONE MONETE A SLITTA</i>
	20		<b>256010</b>	COIN INSERT LEVER <i>LEVA INTRODUZIONE MONETE</i>
	21		<b>262414</b>	COIN SLOT SURROUND <i>COIN SLOT SURROUND</i>
	22		<b>255493</b>	SCREW M4X10 <i>VITE M4X10</i>
	23		<b>0V4264</b>	BLACK MONEY RETURN BUTTON <i>PULSANTE RENDIRESTO NERO</i>
	24		<b>11032946</b>	СЕРМЕНТ БАНКНОТОПРИЙМАЧА FS4N <i>BANKNOTE READER CAP FS4N</i>
	25		<b>11032976</b>	RIGHT TRACK FOR LEXAN FS4N <i>RIGHT TRACK FOR LEXAN FS4N</i>
	26		<b>262383</b>	CAPACITIVE KEYPAD 16+3 KEYS <i>CAPACITIVE KEYPAD 16+3 KEYS</i>

## Model Machine

MACNEC023

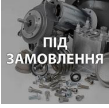
OASI 400-600

	27		<b>262495</b>	EXTERNAL PROFILE -VERSION 400- <i>EXTERNAL PROFILE -VERSION 400-</i>
	28		<b>262494</b>	INTERFACE FRAME <i>INTERFACE FRAME</i>
	29		<b>262426</b>	DOOR STRUCTURE -600- <i>DOOR STRUCTURE -600-</i>
	30		<b>262425</b>	TOP PHOTO PANEL <i>TOP PHOTO PANEL</i>

# Model Machine

MACNEC023

OASI 400-600

MACNEC023.T.0002

TAVOLA NR. 2 - ARTICOLO OASI 400-600

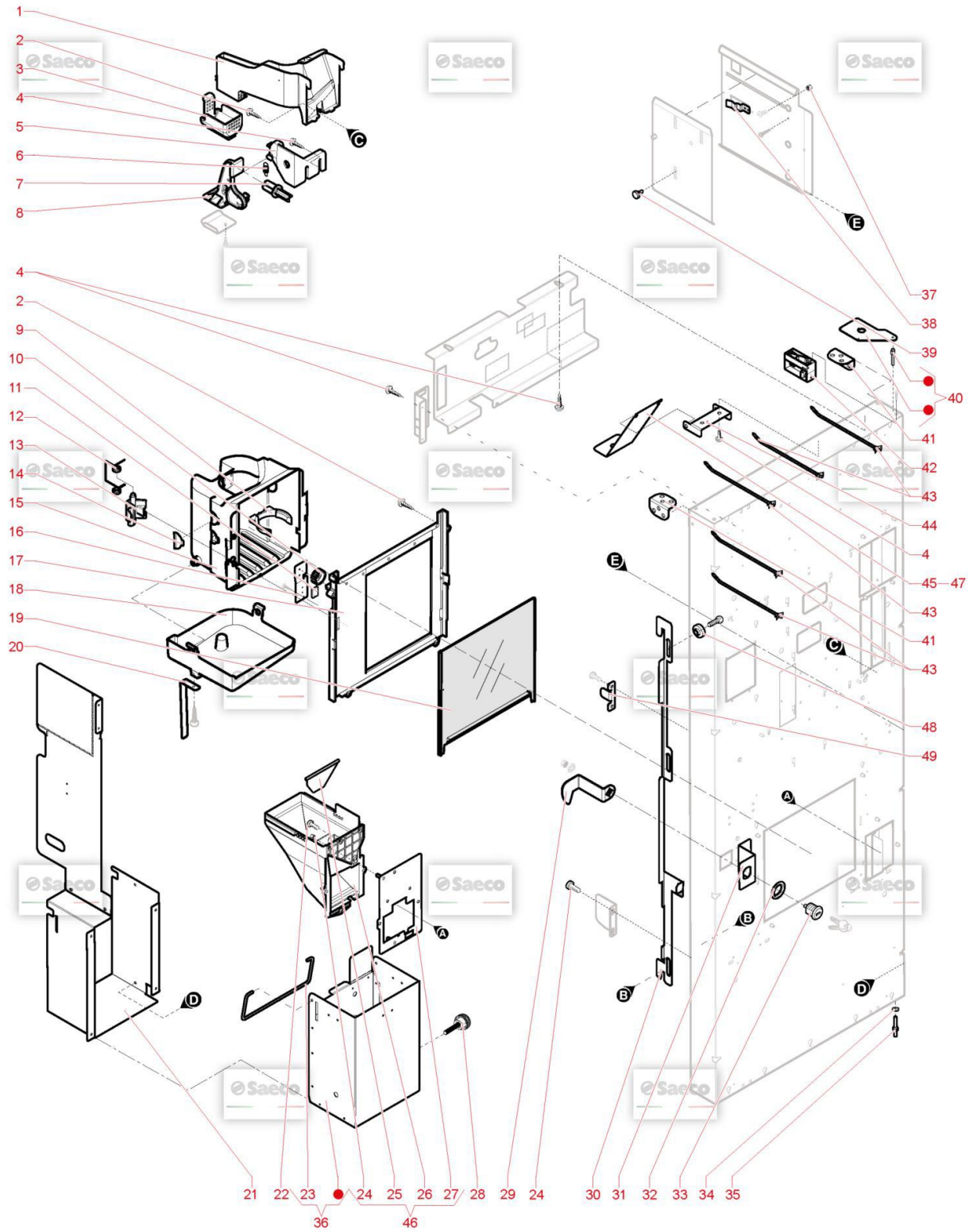

## Model Machine

MACNEC023

OASI 400-600

Web Pos. Foto Item - Replace by Description



Press - CTRL + CLICK go to item in a new window

Натисніть - Ctrl + права кнопка миші щоб відкрити запчастину в новому вікні



1

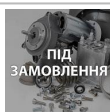

262412

COIN CHUTE  
COIN CHUTE



2

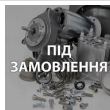

261153

SCREW M4X20  
VITE M4X20



3

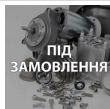

256404

ENDPIECE COIN SLOT CHUTE  
TERMINALE SCIVOLO INTRODUZIONE MONETE



4



255028

SELF-TAPPING SCREW 3,9X9,5  
VITE AUTOFILETT 3,9X9,5



5



0V3706

LEVER SUPPORT  
0V3706



6



987839

RETURN SPRING  
MOLLA RICHIAMO



7



262413

CHANGE BUTTON ADAPTER  
CHANGE BUTTON ADAPTER



8



0V3704

COIN RETURN LEVER  
LEVA RENDIRESTO



9

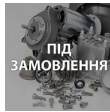

262415

D.70 CUP SURROUND FORK  
FORCELLA SUPPORTO BICCHIERI D.70



10

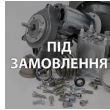

11034002

ASSEMBLY DAMPER+GEAR Z.21  
ASSEMBLY DAMPER+GEAR Z.21



11

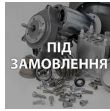

1863.649

REED FOR DOOR  
REED FOR DOOR



12

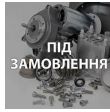

262419

COMPARTMENT LOCKING LEVER SPRING  
COMPARTMENT LOCKING LEVER SPRING



13

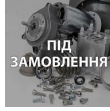











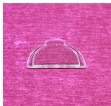

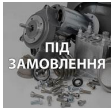

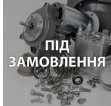

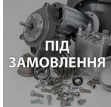

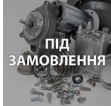

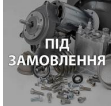



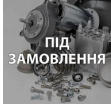

262392

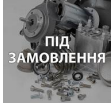
DISPENSING COMPARTMENT LEVER  
DISPENSING COMPARTMENT LEVER

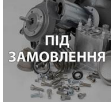
## Model Machine

MACNEC023

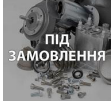















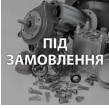





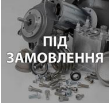

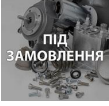
OASI 400-600

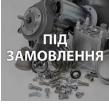
	14		<b>1863.013</b>	LENS FOR COMPARTMENT DISPENSER <i>LENTE X VANO EROGAZIONE</i>
	15		<b>1863.012.050</b>	COMPARTMENT DISPENSER <i>VANO EROGAZIONE</i>
	16		<b>11033871</b>	SLOW DOWN BRACKET CRS EVO <i>SLOW DOWN BRACKET CRS EVO</i>
	17		<b>11032791</b>	DISPENSER VAIN SUPPORT FS4N <i>DISPENSER VAIN SUPPORT FS4N</i>
	18		<b>262406</b>	DISPENSING COMPARTMENT BASIN <i>DISPENSING COMPARTMENT BASIN</i>
	19		<b>11033747</b>	CUP STATION'S DOOR <i>CUP STATION'S DOOR</i>
	20		<b>1863.024</b>	STIRRUP FOR COMPARTMENT DISPENSER <i>STAFFA X VANO EROGATORE</i>
	21		<b>11033725</b>	SUPPORT MONEY BOX <i>SUPPORT MONEY BOX</i>
	22		<b>255937</b>	SCREW M4X14 <i>VITE M4X14</i>
	23		<b>0875.271</b>	HANDLE FOR COIN CASE <i>HANDLE FOR COIN CASE</i>
	24		<b>255044</b>	NUT M5 <i>DADO M5</i>
	25		<b>11011662</b>	ADJUSTABLE PLATE <i>ADJUSTABLE PLATE</i>
	26		<b>11032793</b>	DUCT COIN RECOVERY FS4N <i>CONDOTTO RECUPERO MONETE FS4N</i>
	27		<b>11033002</b>	COIN RECOVER BRACKET FS4N <i>COIN RECOVER BRACKET FS4N</i>

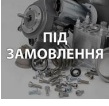
## Model Machine

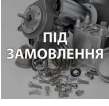
MACNEC023

OASI 400-600











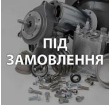

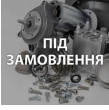

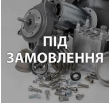

	28		<b>12002033</b>	KNOB D.18 M5X25 <i>KNOB D.18 M5X25</i>
	29		<b>11035103</b>	LEVER LOCK RS1 <i>LEVA SERRATURA RS1 CRS EVO</i>
	30		<b>11033780</b>	ROD FOR LOCK <i>ROD FOR LOCK</i>
	31		<b>11032998</b>	BRACKET FOR LOCK <i>PIASTRA SUPP.SERRATURA FS4N</i>
	32		<b>11014166</b>	LOCK BUSH <i>LOCK BUSH</i>
	33		<b>12002251</b>	LOCK RIELDA MOD. 458 RS1 <i>LOCK RIELDA MOD. 458 RS1</i>
	34		<b>256793</b>	WASHER <i>RONDELLA</i>
	35		<b>262385</b>	BOTTOM HINGE PIN <i>BOTTOM HINGE PIN</i>
	36		<b>262453</b>	COIN BOX ASS. <i>COIN BOX ASS.</i>
	37		<b>259231</b>	NUT M4 <i>DADO M4</i>
	38		<b>0875.114</b>	STIRRER GUIDE RETAINING SPRING <i>STIRRER GUIDE RETAINING SPRING</i>
	39		<b>9111.614</b>	COIN BOX ANCHORING PIN <i>COIN BOX ANCHORING PIN</i>
	40		<b>262377</b>	TOP HINGE ASSEMBLY <i>TOP HINGE ASSEMBLY</i>

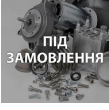

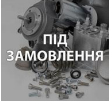
## Model Machine

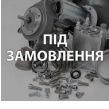
MACNEC023

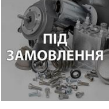
OASI 400-600

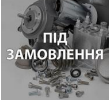
	41		1863.068	ANGULAR ANGULAR
	42		262381	DOOR HINGE BLOCK DOOR HINGE BLOCK
	43		090148	CLIP COLLARE
	44		11009680	BASKET STOP BRACKET SG650 BASKET STOP BRACKET SG650
	45		262421	CUP COVER FLANGE CUP COVER FLANGE
	46		262374	COIN DOOR ASSEMBLY COIN DOOR ASSEMBLY
	47		262424	CUP COVER FLANGE CUP COVER FLANGE
	48		262407	LOCK ROD BUSHING LOCK ROD BUSHING
	49		11008670	BRACKET FOR MICRO BRACKET FOR MICRO

# Model Machine

MACNEC023

OASI 400-600

MACNEC023.T.0003

TAVOLA NR. 3 - ARTICOLO OASI 400-600

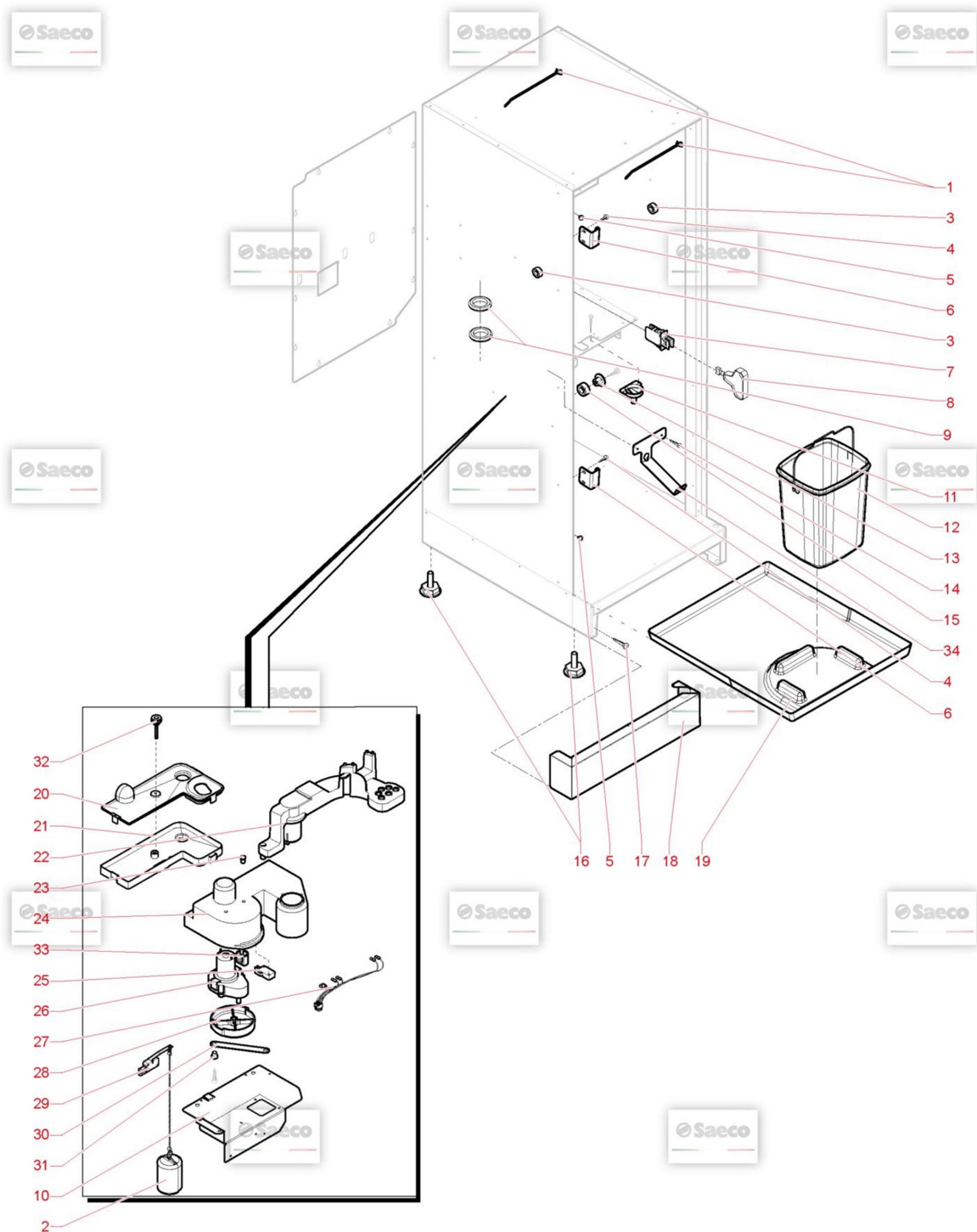

## Model Machine

MACNEC023

OASI 400-600

Web Pos. Foto Item - Replace by Description



Press - CTRL + CLICK go to item in a new window  
Натисніть - Ctrl + права кнопка миші щоб відкрити запчастину в новому вікні



1

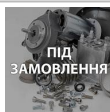

090148

CLIP  
COLLARE



2

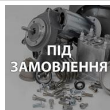

0V2356

FLOT  
FLOT



3

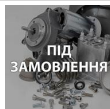

262408

SIDE BUSHING  
SIDE BUSHING



4

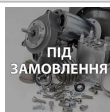

255937

SCREW M4X14  
VITE M4X14



5

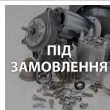

259253

RUBBER WASHER  
GOMMINO



6



11027979

ROD LOCK HOOKUP SEAGA  
AGGANCIO ASTA X SERRATURA A 3 PUNTI



7



097796

МІКРІК XTD 22AZ1 (EX NE05.039, NE05.061)  
INTERRUTTORE



8

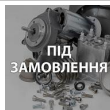

0V1654

SWITCH KEY  
CHIAVE INTERRUTTORE SWITCH KEY



9

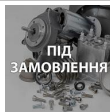

39701300

CABLE GLAND DIA. 30  
CABLE GLAND DIA. 30



10



262455

ARM SUP. ANGLE ASS.  
ARM SUP. ANGLE ASS.



11



262411

DISCHARGE FUNNEL  
DISCHARGE FUNNEL



12

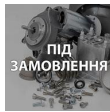

254569

BLUE GROUND BUCKET  
SECCHIO FONDI BLU



13

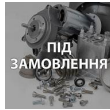













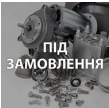













11006477

FS400 DOOR PIVOT FOR WHEEL  
FS400 DOOR PIVOT FOR WHEEL

## Model Machine

MACNEC023











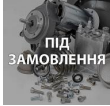

OASI 400-600

	14		255028	SELF-TAPPING SCREW 3,9X9,5 <i>VITE AUTOFILETT 3,9X9,5</i>
	15	 ПІД ЗАМОВЛЕННЯ	11003474	FS400 DOOR WHEEL <i>FS400 DOOR WHEEL</i>
	16		252124	4 FEET KIT <i>KIT 4 PIEDINI</i>
	17		255028	SELF-TAPPING SCREW 3,9X9,5 <i>VITE AUTOFILETT 3,9X9,5</i>
	18	 ПІД ЗАМОВЛЕННЯ	262378	FOOT COVER <i>FOOT COVER</i>
	19	 ПІД ЗАМОВЛЕННЯ	262409	GROUNDS BASIN <i>GROUNDS BASIN</i>
	20	 ПІД ЗАМОВЛЕННЯ	262399	BASIN COVER <i>BASIN COVER</i>
	21	 ПІД ЗАМОВЛЕННЯ	262398	CONDENSATION BASIN <i>BACINELLA CONDENSA</i>
	22	 ПІД ЗАМОВЛЕННЯ	262454	SWIVEL ARM ATL.500 BLUE <i>SWIVEL ARM ATL.500 BLUE</i>
	23	 ПІД ЗАМОВЛЕННЯ	9161.305.150	ЗАГЛУШКА РЕЗИНОВА <i>GREY 8GR.BREW UNIT INTEGRAL PISTON PLUG</i>
	24	 ПІД ЗАМОВЛЕННЯ	11033188	SUPPORT ARM ATLANTE500 <i>SUPPORT ARM ATLANTE500</i>
	25		NE05.002	МІКРОВИМИКАЧ ДЛЯ КАВОМАШИНИ EF83161.8 <i>MICROINTERRUTTORE</i>
	26		11033191	GEARMOTOR MECHTEX 25 RPM <i>MOTORIDUTTORE MECHTEX 25 RPM</i>
	27	 ПІД ЗАМОВЛЕННЯ	11009584	NOZZLE HARNESS SG650 <i>NOZZLE HARNESS SG650</i>

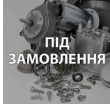
## Model Machine

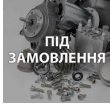
MACNEC023

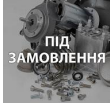
OASI 400-600

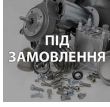
	28		11031824	ЕКЦЕНТРИК РУКИ ATLANTE500 <i>CAM ARM ATLANTE500</i>
	29		252585	MICROSWITCH <i>MICROINTERRUTTORE MICROSWITCH</i>
	30		11023944	CONNECTING ROD ARM ATLANTE500 <i>CONNECTING ROD ARM ATLANTE500</i>
	31		11032865	BUSH <i>BOCCOLA X BILANCERE BRACCIO BICCHIERI</i>
	32		12002032	KNOB D.18 M5X40 <i>VOLANTINO ZIGRINATO D.18 M5X40</i>
	33		11033193	SPACER MOTOR ARM <i>SPACER MOTOR ARM</i>
	34		262420	DISCHARGE SUPPORT <i>DISCHARGE SUPPORT</i>

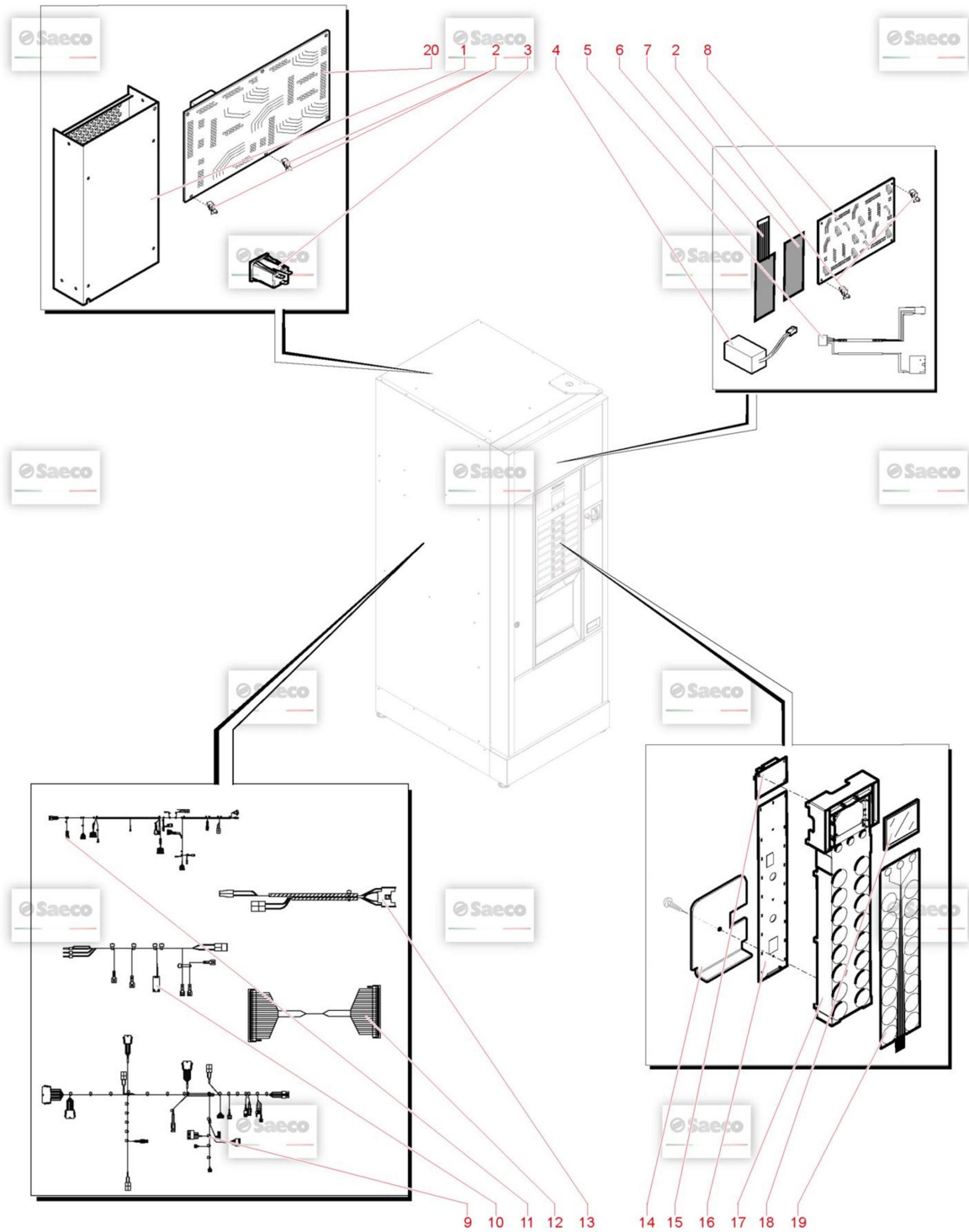

## Model Machine

MACNEC023

OASI 400-600

Web Pos. Foto Item - Replace by Description



*Press - CTRL + CLICK go to item in a new window  
Натисніть - Ctrl + права кнопка миші щоб відкрити запчастину в новому вікні*



1



12002120

SWITCHING DELTA PMT-24V-150W-1A  
ALIMENTATORE DELTA PMT-24V-150W-1A



2



9111.402

SPACER FOR CARD  
SPACER FOR CARD



3



187850400

TRIPOLE SOCKET SELF-LOCKING  
TRIPOLE SOCKET SELF-LOCKING



4



0V2284

SCALER 24 VOLT  
CONTAIMPULSI 24 VOLT SCALER 24 VOLT



5

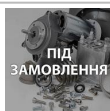

0801.635

T. PANEL HARNESS -C.BOX G26 EXECUT  
T. PANEL HARNESS -C.BOX G26 EXECUT



6



0875.741

TOUCH PANEL  
TOUCH PANEL



7

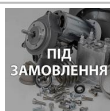

0875.990

TOUCH PANEL PLATE  
TOUCH PANEL PLATE



8

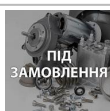

262390

CPU CARD  
CPU CARD



9

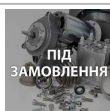

262430

MACHINE BODY SINGLE WIR.  
MACHINE BODY SINGLE WIR.



10

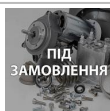

262429

230V POWER CAB. - 24V POWER SUPPLY  
230V POWER CAB. - 24V POWER SUPPLY



11

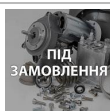

262451

DOOR WIR.  
CABL. PORTA



12

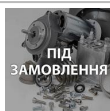

262452

KEY CAPU CARD CONN. WIR.  
KEY CAPU CARD CONN. WIR.



13

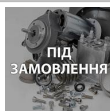















262431

DOOR MICRO WIR.  
DOOR MICRO WIR.

## Model Machine

MACNEC023

OASI 400-600

	14		11035821	FLAT KEYBOARD PROTECTIVE COVERCRS <i>FLAT KEYBOARD PROTECTIVE COVERCRS</i>
	15		11032383	HW INTERF. NEW TFT DISPLAY UMSH-8252MD-T <i>SCHEDA INTERF. DISPLAY TFT UMS H-8252MD-T CRISTALLO400/600/PHE...</i>
	16		11032885	SCHEMA LEDS CAPACITIVA <i>SCHEMA LEDS CAPACITIVA</i>
	17		11032820	DISPLAY / LED SUPPORT FS4N <i>DISPLAY / LED SUPPORT FS4N</i>
	18		11032399	3,5" TFT DISPLAY 320X240 <i>3,5 TFT DISPLAY 320X240</i>
	19		11035860	CAPACITIVE ADHESIVE CIRCUIT 19KEYS V1 <i>CIRCUITO ADESIVO CAPACITIVO 19 TASTI V1</i>
	20		262493	ACTUATION CARD <i>ACTUATION CARD</i>



# Model Machine

MACNEC023

OASI 400-600

MACNEC023.T.0005

TAVOLA NR. 5 - ARTICOLO OASI 400-600

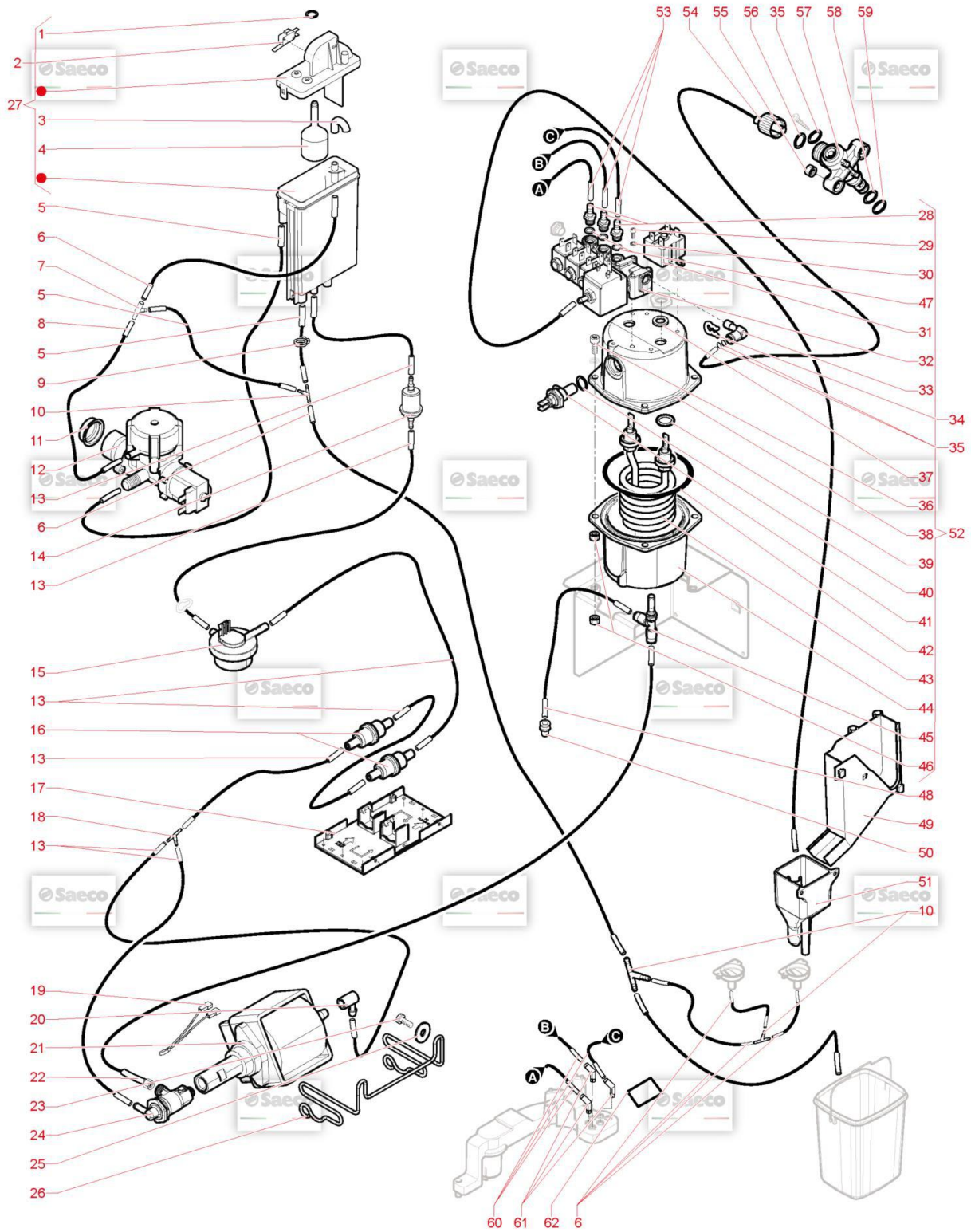















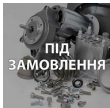

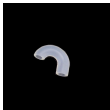

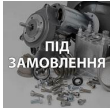

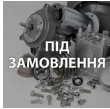



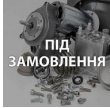

## Model Machine

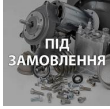
MACNEC023

OASI 400-600

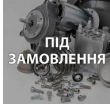
Web Pos. Foto Item - Replace by Description











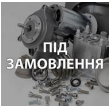















 *Press - CTRL + CLICK go to item in a new window*  
*Натисніть - Ctrl + права кнопка миші щоб відкрити запчастину в новому вікні*

	1		0V0782	O-RING 2025 GUARNIZIONE OR 2025
	2		504065	MICROSWITCH MICROSWITCH
	3		0V1749	ПАТРУБОК РАСШИРИТЕЛЬНОГО БАЧКА RACCORDO ACQUA AIR-BREAK
	4		0V1126	AIR-BREAK FLOAT GALLEGGIANTE AIR-BREAK
	5		097685	SILICONE HOSE BROWN 7,5X12 TUBO SILICONE MARRONE 7.5X12'AL METRO'
	6		097515	СИЛІКОНОВА ТРУБКА 10X16'КОРИЧНЕВА 1МЕТРИ TUBO SILICONE 10X16'MARRONE' MATASSA DA 50 MT NUVO PREZZO P...
	7		094185	CODENSE RECOVERY UNION RACCORDO RECUPERO CONDENSA
	8		097512	СИЛІКОНОВА ТРУБКА 6 X 12 КОРИЧНЕВИЙ (1МЕТРИ) TUBO SILICONE 6X12'MARRONE'
	9		093957	TUBE CLAMP MORSETTO CHIUSURA TUBO
	10		096552	UNION T-SHAPE RACCORDO A T
	12		262391	NETWORK SAFETY SOLENOID VALVE NETWORK SAFETY SOLENOID VALVE
	13		097510	SILICONE HOSE 5X9 BROWN TUBO SILICONE 5X9 MARRONE MATASSA DA 30MT SILICONE HOSE 5X9 ...
	14		097435	ФІЛЬТ ВОДИ ОБ'ЄМНОГО ЛІЧИЛЬНИКА (400 MICRONS) НЕСТА LAVAZZA FILTRO ACQUA PERCONT.VOLUMETRICO

## Model Machine

MACNEC023

















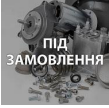





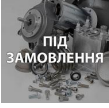

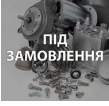
OASI 400-600

	15		258852	СЧЕТЧИК ВОДЫ 1.2, НЕСТА 258852 SAECO NV99099 <i>CONTATORE VOLUMETRICO D=1.2</i>
	16		11036374	FILTER INTAKE IN LUNG WATER SUPPLY PP <i>FILTER INTAKE IN LUNG WATER SUPPLY PP</i>
	17		11033067	PANEL FOR ORIENTATION FILTERS <i>PANEL FOR ORIENTATION FILTERS</i>
	18		094231	UNION T-SHAPE <i>RACCORDO A T</i>
	19		0V1301	110 DEGREES THERMAL OVERLOAD <i>PROTETTORE TERMICO 110 GRADI</i>
	20		503962	BEND <i>BEND</i>
	21		257112	ПОМПА GW EP5 ULKA 230V 50HZ <i>POMPA EP5 230V 50HZ PLASTICA -CORPO ROSSO/ROSA-</i>
	22		262441	HOSE ASSEMBLY VNR L=220 <i>HOSE ASSEMBLY VNR L=220</i>
	23		255028	SELF-TAPPING SCREW 3,9X9,5 <i>VITE AUTOFIETT 3,9X9,5</i>
	24		257729	КЛАПАН V.N.R.-BYPASS ASSY. 12БАР <i>ASSIEME V.N.R.-BY PASS -12BAR-</i>
	25		093091	АМОТИЗАТОР ПОМПИ <i>AMMORTIZZATORE PER POMPA .</i>
	26		098697	КРЕПЛЕНИЕ ПОМПЫ (EUROS) НЕСТА BIANCHI <i>SUPPORTO POMPA</i>
	27		0V1133	AIR-BREAK ASSEMBLY <i>AIR-BREAK ASSEMBLY</i>
	28		099012	RUBBERHOLDER UNION <i>RACCORDO PORTAGOMMA 2 MM</i>

## Model Machine

MACNEC023















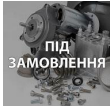

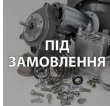

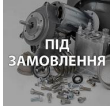



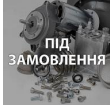

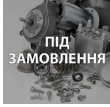

OASI 400-600

	29		<b>260398</b>	SCREW M4X35 VITE M4X35
	30		<b>A-0136</b>	TOOTHED WASHER EXT. 4.3 DIN 6798 ROSETTA DENT. EST 4.3 DIN 6798
	31		<b>0V1318</b>	125 DEGR. THERMOSTAT TERMOSTATO 125 GRADI
	32		<b>262375</b>	GROUP OF 2+2+2+3- WAY 24V SOL.VALVES (4) GROUP OF 2+2+2+3- WAY 24V SOL.VALVES (4)
	33		<b>9181.348</b>	TEA/BRASS CONNECTOR 1/8" CONICAL AT 90° TEA/BRASS CONNECTOR 1/8 CONICAL AT 90°
	34		<b>9011.144</b>	SS FORK FOR TUBE D=4 FORCELLA X TUBO D.4
	35		<b>140328059</b>	OR 2015 SILICONE PTFE/FDA OR 2015 SILICONE PTFE/FDA
	36		<b>255043</b>	SCREW M5X20 VITE M5X20
	37		<b>254710</b>	ELASTIC BENT WASHER ROSETTA ELASTICA CURVA
	38		<b>257335</b>	TOP CAP 300CC BOILER TANK-INOX- CALOTTA SUPERIORE 300CC-INOX-
	39		<b>254711</b>	GASKET O-RING112 2.62X9.92-HEATING ELEMENT- GUARNIZIONE OR112 2.62X9.92-RE SISTENZA CALDAIA-
	40		<b>095624</b>	GASKET O-RING 116 EP851 GUARNIZIONE OR 116 EP851 NUOVO PREZZO 0,12
	41		<b>259898</b>	NEW TEMPERATURE PROBE NUOVA SONDA TEMPERATURA-TORNAT

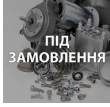
## Model Machine

MACNEC023

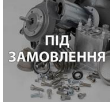













OASI 400-600

	42		098701	ES. BOILER GASKET-300CC- <i>GUARNRZRONE CALDATA ES.-300CC</i>
	43		099653	HEATING ELEMENT 1450 W <i>HEATING ELEMENT 1450 W</i>
	44		257336	BOTTOM CAP 300CC BOILER TANK-INOX- <i>CALOTTA INFERIORE 300CC-INOX-</i>
	45		259081	T-SHAPED SIDE CONNECTOR 6-1/8+TUBE-DOUBLE SEAL- <i>RACCORDO T LATERALE 6-1/8+TUBETTO-DOPPIA TENUTA-</i>
	46		255044	NUT M5 <i>DADO M5</i>
	47		094594	GASKET O-RING 2031 <i>GUARNIZIONE OR 2031</i>
	48		252658	TEFLON PIPE 3X6 (A METER) <i>TUBO TEFLON 3X6 (AL METRO)</i>
	49		9111.597.050	COFFEE DISCHARGE CHANNEL SHORT <i>CANALINO SCARICO CAFFE' CORTO</i>
	50		257049	CAP FEM. 6 DEP. <i>TAPPO FEMMINA 6 DEP.</i>
	51		262410	CONVEYOR <i>CONVEYOR</i>
	52		262376	300CC BOILER ASSEMBLY <i>300CC BOILER ASSEMBLY</i>
	53		097529	ТРУБКА СИЛИКОНОВАЯ 3X6 ММ, КОРИЧНЕВАЯ (1МЕТР) BIANCHI 09087... <i>TUBO MARRONE 3X6 CAFFE</i>
	54		262438	TEFLON HOSE ASS. 4X2X160 GODRON <i>TEFLON HOSE ASS. 4X2X160 GODRON</i>
	55		096094	NUT <i>DADO</i>

## Model Machine

MACNEC023

OASI 400-600

	56		12001810	OR 275 DE.8,04 SILICONE PERNOMANICOTTO <i>OR 275 DE.8,04 SILICONE PERNO MANICOTTO</i>
	57		11005370	PIN FOR MUFF <i>PERNO X MANICOTTO PIN FOR MUFF</i>
	58		11013173	OR ORM 0090-20 FKM 80 FD GREENPEROXIDA <i>OR ORM 0090-20 FKM 80 FD GREEN PEROXIDA</i>
	59		11013174	OR ORM 0050-20 FKM 80 FD GREENPEROXIDA <i>OR ORM 0050-20 FKM 80 FD GREEN PEROXIDA</i>
	60		254565	ТРУБКА СИЛІКОНОВА СИНЯ 5X9 1 МЕТРИ <i>TUBO SILICONE BLU 5X9</i>
	61		262394	ELBOW DISPENSING NOZZLE <i>ELBOW DISPENSING NOZZLE</i>
	62		140321762	O-RING 3218 SILICONE <i>O-RING 3218 SILICONE</i>

# Model Machine

MACNEC023

OASI 400-600

MACNEC023.T.0006

TAVOLA NR. 6 - ARTICOLO OASI 400-600

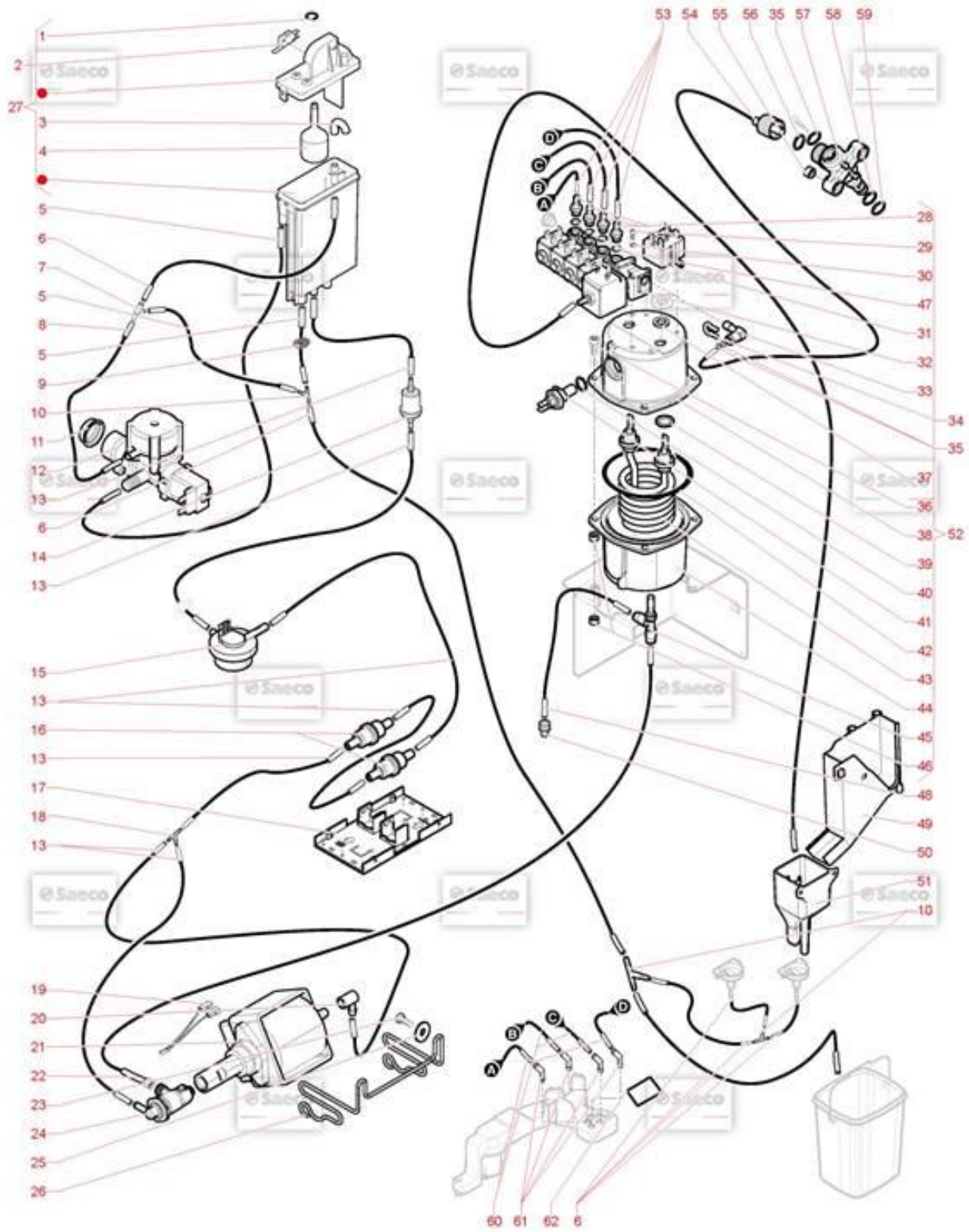

## Model Machine

MACNEC023

OASI 400-600

Web Pos. Foto Item - Replace by Description



Press - CTRL + CLICK go to item in a new window

Натисніть - Ctrl + права кнопка миші щоб відкрити запчастину в новому вікні











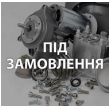















	1		0V0782	O-RING 2025 GUARNIZIONE OR 2025
	2		504065	MICROSWITCH MICROSWITCH
	3		0V1749	ПАТРУБОК РАСШИРИТЕЛЬНОГО БАЧКА RACCORDO ACQUA AIR-BREAK
	4		0V1126	AIR-BREAK FLOAT GALLEGGIANTE AIR-BREAK
	5		097685	SILICONE HOSE BROWN 7,5X12 TUBO SILICONE MARRONE 7.5X12'AL METRO'
	6		097515	СИЛІКОНОВА ТРУБКА 10X16'КОРИЧНЕВА 1МЕТРИ TUBO SILICONE 10X16'MARRONE' MATASSA DA 50 MT NUVO PREZZO P...
	7		094185	CODENSE RECOVERY UNION RACCORDO RECUPERO CONDENSA
	8		097512	СИЛІКОНОВА ТРУБКА 6 X 12 КОРИЧНЕВИЙ (1МЕТРИ) TUBO SILICONE 6X12'MARRONE'
	9		093957	TUBE CLAMP MORSETTO CHIUSURA TUBO
	10		096552	UNION T-SHAPE RACCORDO A T
	12		262391	NETWORK SAFETY SOLENOID VALVE NETWORK SAFETY SOLENOID VALVE
	13		097510	SILICONE HOSE 5X9 BROWN TUBO SILICONE 5X9 MARRONE MATASSA DA 30MT SILICONE HOSE 5X9 ...
	14		097435	ФІЛЬТ ВОДИ ОБ'ЄМНОГО ЛІЧИЛЬНИКА (400 MICRONS) НЕСТА LAVAZZA FILTRO ACQUA PERCONT.VOLUMETRICO



## Model Machine

MACNEC023

















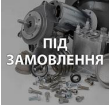





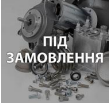

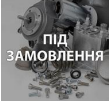
OASI 400-600

	15		<b>258852</b>	СЧЕТЧИК ВОДЫ 1.2, NECTA 258852 SAECO NV99099 <i>CONTATORE VOLUMETRICO D=1.2</i>
	16		<b>11036374</b>	FILTER INTAKE IN LUNG WATER SUPPLY PP <i>FILTER INTAKE IN LUNG WATER SUPPLY PP</i>
	17		<b>11033067</b>	PANEL FOR ORIENTATION FILTERS <i>PANEL FOR ORIENTATION FILTERS</i>
	18		<b>094231</b>	UNION T-SHAPE <i>RACCORDO A T</i>
	19		<b>0V1301</b>	110 DEGREES THERMAL OVERLOAD <i>PROTETTORE TERMICO 110 GRADI</i>
	20		<b>503963</b>	LOWER BASE <i>LOWER BASE</i>
	21		<b>257112</b>	ПОМПА GW EP5 ULKA 230V 50HZ <i>POMPA EP5 230V 50HZ PLASTICA -CORPO ROSSO/ROSA-</i>
	22		<b>262441</b>	HOSE ASSEMBLY VNR L=220 <i>HOSE ASSEMBLY VNR L=220</i>
	23		<b>255028</b>	SELF-TAPPING SCREW 3,9X9,5 <i>VITE AUTOFIETT 3,9X9,5</i>
	24		<b>257729</b>	КЛАПАН V.N.R.-BYPASS ASSY. 12БАР <i>ASSIEME V.N.R.-BY PASS -12BAR-</i>
	25		<b>093091</b>	АМОТИЗАТОР ПОМПИ <i>AMMORTIZZATORE PER POMPA .</i>
	26		<b>098697</b>	КРЕПЛЕНИЕ ПОМПЫ (EUROS) NECTA BIANCHI <i>SUPPORTO POMPA</i>
	27		<b>0V1133</b>	AIR-BREAK ASSEMBLY <i>AIR-BREAK ASSEMBLY</i>
	28		<b>099012</b>	RUBBERHOLDER UNION <i>RACCORDO PORTAGOMMA 2 MM</i>

## Model Machine

MACNEC023























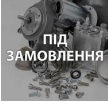

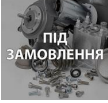

OASI 400-600

	29		<b>260398</b>	SCREW M4X35 <i>VITE M4X35</i>
	30		<b>A-0136</b>	TOOTHED WASHER EXT. 4.3 DIN 6798 <i>ROSETTA DENT. EST 4.3 DIN 6798</i>
	31		<b>0V1318</b>	125 DEGR. THERMOSTAT <i>TERMOSTATO 125 GRADI</i>
	32		<b>262427</b>	GROUP OF 3+2+2+2+2-WAY 24V SOL. VALVE (5) -NO WAND- <i>GROUP OF 3+2+2+2+2-WAY 24V SOL. VALVE (5) -NO WAND-</i>
	33		<b>9181.348</b>	TEA/BRASS CONNECTOR 1/8" CONICAL AT 90° <i>TEA/BRASS CONNECTOR 1/8 CONICAL AT 90°</i>
	34		<b>9011.144</b>	SS FORK FOR TUBE D=4 <i>FORCELLA X TUBO D.4</i>
	35		<b>140328059</b>	OR 2015 SILICONE PTFE/FDA <i>OR 2015 SILICONE PTFE/FDA</i>
	36		<b>255043</b>	SCREW M5X20 <i>VITE M5X20</i>
	37		<b>254710</b>	ELASTIC BENT WASHER <i>ROSETTA ELASTICA CURVA</i>
	38		<b>257335</b>	TOP CAP 300CC BOILER TANK-INOX- <i>CALOTTA SUPERIORE 300CC-INOX-</i>
	39		<b>254711</b>	GASKET O-RING 112 2.62X9.92-HEATING ELEMENT- <i>GUARNIZIONE OR112 2.62X9.92-RE SISTENZA CALDAIA-</i>
	40		<b>095624</b>	GASKET O-RING 116 EP851 <i>GUARNIZIONE OR 116 EP851 NUOVO PREZZO 0,12</i>
	41		<b>259898</b>	NEW TEMPERATURE PROBE <i>NUOVA SONDA TEMPERATURA-TORNAT</i>

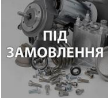
## Model Machine

MACNEC023

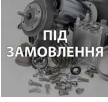













OASI 400-600

	42		098701	ES. BOILER GASKET-300CC- <i>GUARNRZRONE CALDATA ES.-300CC</i>
	43		099653	HEATING ELEMENT 1450 W <i>HEATING ELEMENT 1450 W</i>
	44		257336	BOTTOM CAP 300CC BOILER TANK-INOX- <i>CALOTTA INFERIORE 300CC-INOX-</i>
	45		259081	T-SHAPED SIDE CONNECTOR 6-1/8+TUBE-DOUBLE SEAL- <i>RACCORDO T LATERALE 6-1/8+TUBETTO-DOPPIA TENUTA-</i>
	46		255044	NUT M5 <i>DADO M5</i>
	47		094594	GASKET O-RING 2031 <i>GUARNIZIONE OR 2031</i>
	48		252658	TEFLON PIPE 3X6 (A METER) <i>TUBO TEFLON 3X6 (AL METRO)</i>
	49		9111.597.050	COFFEE DISCHARGE CHANNEL SHORT <i>CANALINO SCARICO CAFFE' CORTO</i>
	50		257049	CAP FEM. 6 DEP. <i>TAPPO FEMMINA 6 DEP.</i>
	51		262410	CONVEYOR <i>CONVEYOR</i>
	52		262364	300CC BOILER ASSEMBLY <i>300CC BOILER ASSEMBLY</i>
	53		097529	ТРУБКА СИЛИКОНОВАЯ 3X6 ММ, КОРИЧНЕВАЯ (1МЕТР) BIANCHI 09087... <i>TUBO MARRONE 3X6 CAFFE</i>
	54		262438	TEFLON HOSE ASS. 4X2X160 GODRON <i>TEFLON HOSE ASS. 4X2X160 GODRON</i>
	55		096094	NUT <i>DADO</i>

## Model Machine

MACNEC023

OASI 400-600

	56		12001810	OR 275 DE.8,04 SILICONE PERNOMANICOTTO <i>OR 275 DE.8,04 SILICONE PERNO MANICOTTO</i>
	57		11005370	PIN FOR MUFF <i>PERNO X MANICOTTO PIN FOR MUFF</i>
	58		11013173	OR ORM 0090-20 FKM 80 FD GREENPEROXIDA <i>OR ORM 0090-20 FKM 80 FD GREEN PEROXIDA</i>
	59		11013174	OR ORM 0050-20 FKM 80 FD GREENPEROXIDA <i>OR ORM 0050-20 FKM 80 FD GREEN PEROXIDA</i>
	60		254565	ТРУБКА СИЛІКОНОВА СИНЯ 5X9 1 МЕТРИ <i>TUBO SILICONE BLU 5X9</i>
	61		262394	ELBOW DISPENSING NOZZLE <i>ELBOW DISPENSING NOZZLE</i>
	62		140321762	O-RING 3218 SILICONE <i>O-RING 3218 SILICONE</i>

# Model Machine

MACNEC023

OASI 400-600

MACNEC023.T.0007

TAVOLA NR. 7 - ARTICOLO OASI 400-600

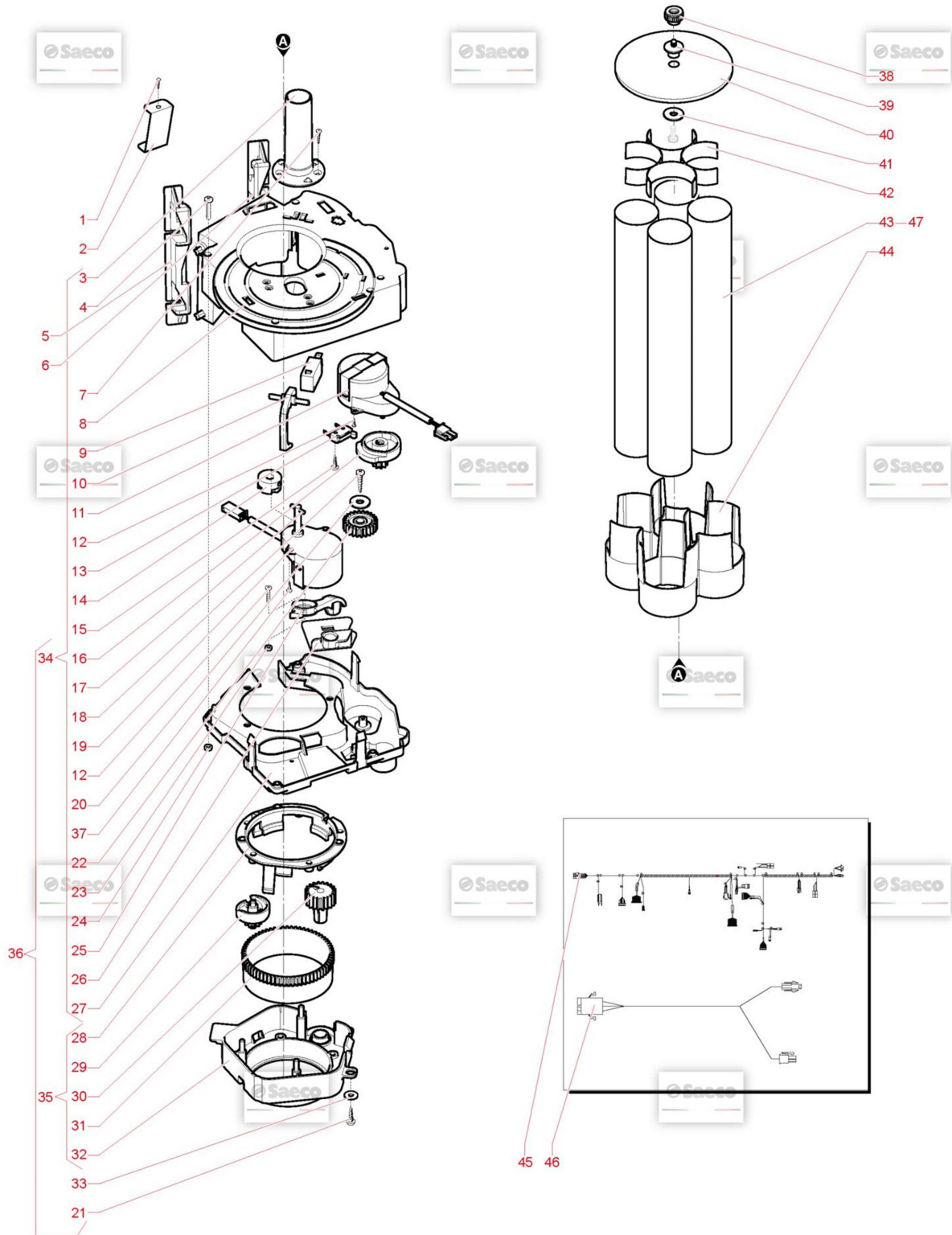















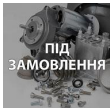









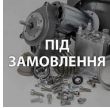

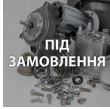
## Model Machine

MACNEC023

OASI 400-600

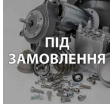
Web Pos. Foto Item - Replace by Description











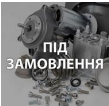

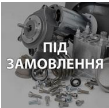













 *Press - CTRL + CLICK go to item in a new window*  
*Натисніть - Ctrl + права кнопка миші щоб відкрити запчастину в новому вікні*

	1		<b>255028</b>	SELF-TAPPING SCREW 3,9X9,5 <i>VITE AUTOFILETT 3,9X9,5</i>
	2	 ПІД ЗАМОВЛЕННЯ	<b>262422</b>	CUP DISTRIBUTOR PLATE <i>CUP DISTRIBUTOR PLATE</i>
	3		<b>11000642</b>	TUBE FOR BASKET GLASSES <i>CANOTTO PER CESTELLO BICCHIERI</i>
	4	 LIBERTY UKRAINE	<b>U034.001</b>	SCREW TCI M3,0X30 UNI 6107 GALV. <i>VITE TCI M3,0X30 UNI 6107 ZNP</i>
	5		<b>1863.032.A20</b>	CUP DISTR. SUPPORT <i>SUPPORTO DISTRIBUTORE BICCH.SX</i>
	6		<b>1863.033.A20</b>	CUP DISTR. SUPPORT <i>SUPPORTO DISTRIBUTORE BICCH.DX</i>
	7	 ПІД ЗАМОВЛЕННЯ	<b>U111.008</b>	NICK.SCREW AUT.TSP 3,5X9,5 DIN7982 C <i>NICK.SCREW AUT.TSP 3,5X9,5 DIN 7982 C</i>
	8	 ПІД ЗАМОВЛЕННЯ	<b>262446</b>	TOP BODY OF DISTRIBUTOR B <i>TOP BODY OF DISTRIBUTOR B</i>
	9		<b>NE05.065</b>	MICROSWITCH CHERRY D41R-QGAD_61 <i>MICROINTERRUTTORE CHERRY D419Q1A ATLANTE CRISTALLO NEXTAGE</i>
	10		<b>1813.067.A20</b>	LEVER <i>LEVA PRESENZA BICCHIERI</i>
	11	 ПІД ЗАМОВЛЕННЯ	<b>262445</b>	CUP RELEASE MOTOR <i>CUP RELEASE MOTOR</i>
	12		<b>129852821</b>	TSP SCREW M3X14 UNI 7688 SS <i>TSP SCREW M3X14 UNI 7688 SS</i>
	13		<b>NE05.064</b>	MICROSWITCH SAIA V4NC <i>MICROINTERRUTTORE SAIA V4NC</i>

## Model Machine

MACNEC023

















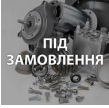





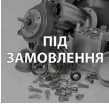

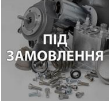
OASI 400-600

	14		<b>262462</b>	4-COLUMN CENTRING CAM <i>4-COLUMN CENTRING CAM</i>
	15		<b>129510503</b>	SCREW TCB 2,2X12,7 DIN 7981 NICK <i>SCREW TCB 2,2X12,7 DIN 7981 NICK</i>
	16		<b>1863.066.A20</b>	DISENGAGE CAM GLASSES <i>DISENGAGE CAM GLASSES</i>
	17		<b>11009494</b>	BRASS FOR MOTOR SAIA UDS1 COD.416616310 <i>BRASS FOR MOTOR SAIA UDS1 COD.416616310</i>
	18		<b>U116.005</b>	SCREW AUT.PT TCB 3,0X8 WN 1441 <i>VITE AUT.PT TCB 3,0X8 WN 1441 ZNP</i>
	19		<b>262444</b>	COLUMN ROTATING MOTOR <i>MOTORE ROTAZIONE COLONNA</i>
	20		<b>U201.001</b>	PLAIN WASHER 3,2X9 DIN 7349 GALV. <i>PLAIN WASHER 3,2X9 DIN 7349 GALV.</i>
	21		<b>U116.005</b>	SCREW AUT.PT TCB 3,0X8 WN 1441 <i>VITE AUT.PT TCB 3,0X8 WN 1441 ZNP</i>
	22		<b>1813.068.A20</b>	TOOTHED WHEEL <i>TOOTHED WHEEL</i>
	23		<b>U310.001</b>	МЕТАЛЕВА ГАЙКА M3 UNI 7473 ZNP <i>DADO AUTOBLOC M3 UNI 7473 ZNP</i>
	24		<b>U324.005</b>	NUT M3 FLANGED INDENTED BASE <i>DADO M3 FLANGIATO BASE DENTELLATA</i>
	25		<b>11007352</b>	LEVER <i>LEVER</i>
	26		<b>11007356</b>	MICRO COVER <i>MICRO COVER</i>
	27		<b>1813.062.A20</b>	LOWER CASING DISPENSER GLASSES <i>LOWER CASING DISPENSER GLASSES</i>

## Model Machine

MACNEC023

OASI 400-600











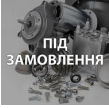

	28		<b>11000786</b>	RETAINING RING <i>RETAINING RING</i>
	29		<b>262460</b>	D.70 CUP SCROLL <i>SATELLITE X BICCH. D.70</i>
	30		<b>1813.074.A20</b>	TOOTHED WHEEL <i>TOOTHED WHEEL</i>
	31		<b>1813.073.A20</b>	TOOTHED WHEEL FOR SNAIL <i>TOOTHED WHEEL FOR SNAIL</i>
	32		<b>11000833</b>	SNAIL SUPPORT <i>SNAIL SUPPORT</i>
	33		<b>U212.006</b>	WASHER 3,2X11X0,5 ZNP <i>WASHER 3,2X11X0,5 ZNP</i>
	34		<b>262443</b>	DISPENSER BODY ASS. <i>DISPENSER BODY ASS.</i>
	35		<b>262448</b>	D7 SCROLL SUPPORT <i>D7 SCROLL SUPPORT</i>
	36		<b>262442</b>	D.70 CUP DISTRIBUTOR ASS. <i>D.70 CUP DISTRIBUTOR ASS.</i>
	37		<b>U109.005</b>	SCREW AUT.TCB 3,5X16 DIN 7981C <i>VITE AUT.TCB 3,5X16 DIN 798</i>
	38		<b>12002034</b>	KNOB WITH BUSH M5 <i>KNOB WITH BUSH M5</i>
	39		<b>11010585</b>	CENTRAL PIN FOR CUP COLUMN <i>CENTRAL PIN FOR CUP COLUMN</i>
	40		<b>11028032</b>	TANK LID GLASSES <i>TANK LID GLASSES</i>

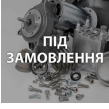

## Model Machine

MACNEC023

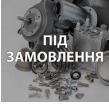
OASI 400-600

	41		<b>U207.009</b>	PLAIN WASHER 5,5X15 UNI 6593 GA <i>PLAIN WASHER 5,5X15 UNI 6593 GA</i>
	42		<b>11005072</b>	CUP TUBE FIXING SPRING <i>CUP TUBE FIXING SPRING</i>
	43		<b>1863.054</b>	CUP TUBE <i>TUBO BICCHIERI</i>
	44		<b>11000976</b>	TANK DRINKS <i>SERBATOIO BICCHIERI UNIFICATO</i>
	45		<b>262447</b>	OASI CUP MICRO WIR. <i>OASI CUP MICRO WIR.</i>
	46		<b>1863.639</b>	HARNESS MOTOR DISPENCER <i>HARNESS MOTOR DISPENCER</i>
	47		<b>11001422</b>	TUBE PVC 80X1.5 L=705 <i>TUBE PVC 80X1.5 L=705</i>

# Model Machine

MACNEC023

OASI 400-600

MACNEC023.T.0008

TAVOLA NR. 8 - ARTICOLO OASI 400-600

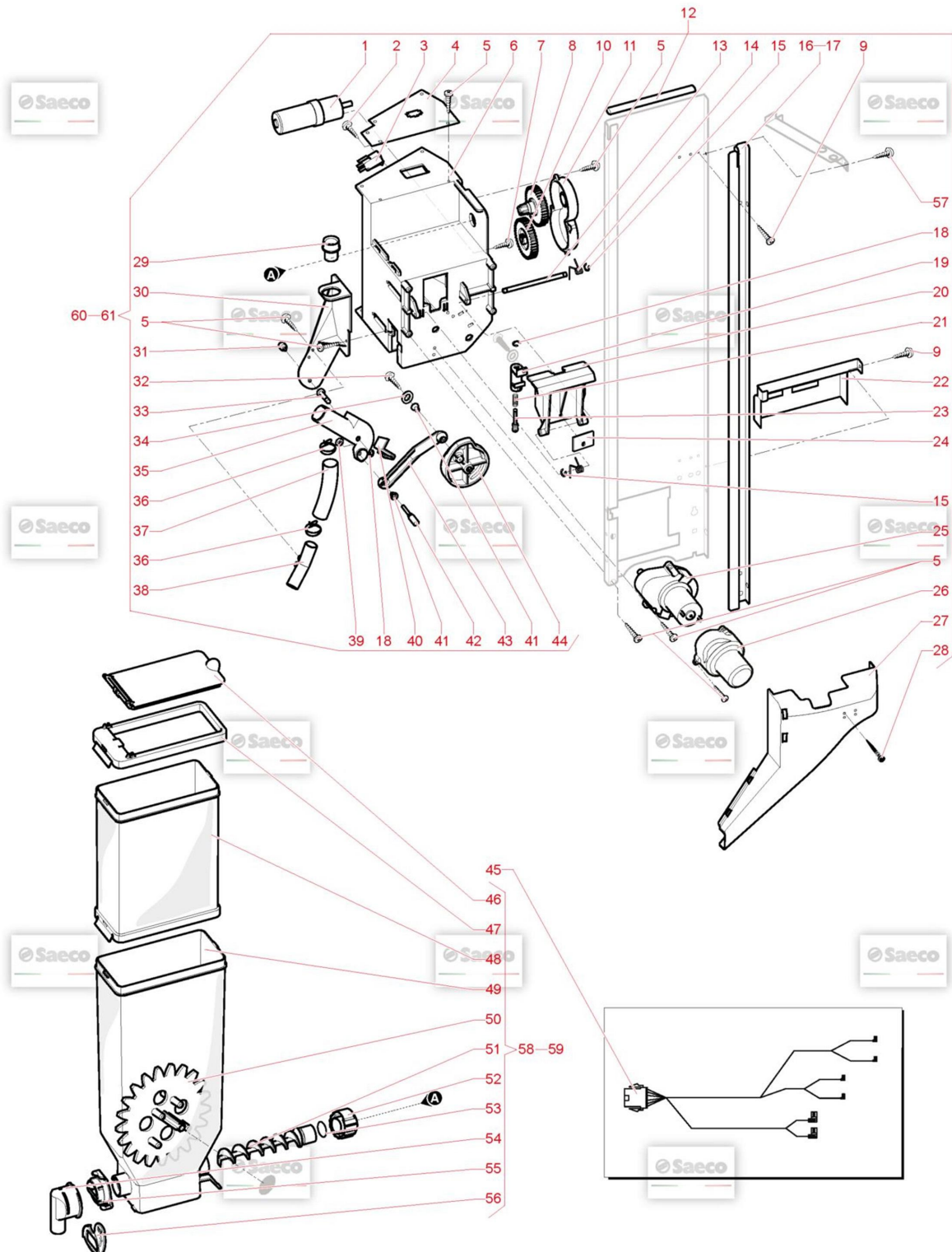

## Model Machine

MACNEC023

OASI 400-600

Web Pos. Foto Item - Replace by Description



Press - CTRL + CLICK go to item in a new window

Натисніть - Ctrl + права кнопка миші щоб відкрити запчастину в новому вікні



1



9121.106.00P

SUGAR RATIONMOTOR 24V DC  
MOTORIDUTTORE ZUCCHERO 24V D.C.



2

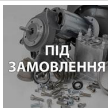

U110.007

SCREW AUT.TCB 2,9X16 DIN 7981F ZNP  
SCREW AUT.TCB 2,9X16 DIN 7981 F ZNP



3



NE05.002

МІКРОВИМИКАЧ ДЛЯ КАВОМАШИНИ EF83161.8  
MICROINTERRUTTORE



4

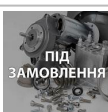

262449

STIRRER DISTR. SUPPORT PLATE  
STIRRER DISTR. SUPPORT PLATE



5



U116.006

SCREW AUT.PT TCB 3,5X12 WN 1441 ZNP  
VITE AUT.PT TCB 3,5X12 WN 1441 ZNP



6



11033196

СУПОРТ МЕХАНІЗМА МЕШАЛКИ САХАРА  
SUPP.PALETTIERA



7



U116.005

SCREW AUT.PT TCB 3,0X8 WN 1441  
VITE AUT.PT TCB 3,0X8 WN 1441 ZNP



8



9111.694

JOINT WITH GEAR  
GIUNTO CON INGRANAGGIO



9



U110.004

SCREW AUT.TCB 3,5X6,5 DIN 7981F  
VITE AUT.TCB 3,5X6,5 DIN 7981 F NIK



10



9111.695

GEAR Z40  
INGRANAGGIO Z 40



11



9111.687.A20

GEAR COVER  
COPERCHIO INGRANAGGI



12

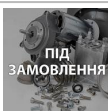

090203

STIRRER BAR WEIGHT L=95  
PESO PER PALETTE L=95



13

















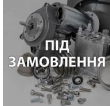

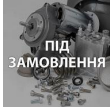









9111.376

PIN FOR STIRRER EXPELLER  
PIN FOR STIRRER EXPELLER

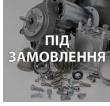
## Model Machine

MACNEC023























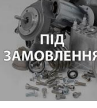

OASI 400-600

	14		9111.730	SPRING <i>MOLLA ESPULSORE PALETTE</i>
	15		U701.006	ФІКСУЮЧА СКОБА 3,2 (ЗАПІЗО) SAECO <i>ANELLO ELASTICO 3,2</i>
	16		262450	STIR. GUIDE REG.1700 OASI/CRS <i>STIR. GUIDE REG.1700 OASI/CRS</i>
	17		262492	STIRRER GUIDE -VERSION 600- <i>STIRRER GUIDE -VERSION 600-</i>
	18		U701.011	STEEL SNAP RING 5 UNI 7434 <i>ANELLO ELASTICO 5 UNI 7434</i>
	19		9111.737	ОПОРА ТРУБКА ПЛАСТИКОВАЯ <i>SUPPORT</i>
	20		11011240	STIRRER EXPELLER BLACK NEW <i>STIRRER EXPELLER BLACK NEW</i>
	21		11031341	SPRING <i>SPRING</i>
	22		11007444	CARTER <i>CARTER</i>
	23		11002209	PIN <i>PIN</i>
	24		11025089	PLATE REINFORCEMENT <i>PIASTRINA RINFORZO ESPULSORE</i>
	25		11033191	GEARMOTOR MECHTEX 25 RPM <i>MOTORIDUTTORE MECHTEX 25 RPM</i>
	26		11025411	CRISTALLO SPOON'S MOTOR COVER <i>CRISTALLO SPOON'S MOTOR COVER</i>
	27		9111.698.A20	STIRRER SLIDE <i>SCIVOLO PALETTE</i>

## Model Machine

MACNEC023



















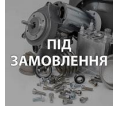







OASI 400-600

	28		9161.082	RUBBER COUPLER <i>AGGANCIO IN GOMMA</i>
	29		9111.699	ПЕРЕХОДНИК-ДЕРЖАТЕЛЬ ДЛЯ ТРУБКИ ВЫДАЧИ САХАРА КОФЕМАШИ... <i>BOCCHETTA TUBO ZUCCHERO</i>
	30		9111.686.A20	SUPPORT SUGAR CONVEYER <i>SUPPORTO BASCULINA ZUCCHERO</i>
	31		11000388	KNOB M3 SUGAR CONVEYER <i>POMELLO M 3 BASCULINA ZUCCHERO</i>
	32		U116.004	SCREW AUT.PT TCB 3,0X16 WN 1441 <i>SCREW AUT.PT TCB 3,0X16 WN 1441</i>
	33		11000389	GRAINED PIVOT SUGAR COVEYER <i>PERNO ZIGRINATO BASCULINA ZUCCHERO</i>
	34		U201.001	PLAIN WASHER 3,2X9 DIN 7349 GALV. <i>PLAIN WASHER 3,2X9 DIN 7349 GALV.</i>
	35		9111.690	SUGAR CONVEYER <i>BASCULINA ZUCCHERO</i>
	36		9111.553	SELF-ENERGIZING SPRING FOR TUBE D.2 <i>SELF-ENERGIZING SPRING FOR TUBE D.2</i>
	37		9111.700	SUGAR TUBE <i>TUBO ZUCCHERO</i>
	38		9111.697	CONNECTOR SUGAR TUBE <i>RACCORDO TUBO ZUCCHERO</i>
	39		123160302	NUT M3 HIGH UNI 5587 GALVANIZED <i>NUT M3 HIGH UNI 5587 GALVANIZED</i>
	40		9111.727	BULKHEAD SUGAR CONVEYER <i>PARATIA BASCULINA ZUCCHERO</i>

## Model Machine

MACNEC023















OASI 400-600

	41		9111.705	SPHERICAL PIN <i>PERNO SFERICO</i>
	42		11004295	KNOB FOR SUGAR CONNECTING RODPIPE <i>POMELLO BLOCCAGGIO BIELLA TUBO ZUCCH.</i>
	43		9111.691	CONNECTING ROD SUGAR DISPENCER <i>BIELLA DISTRIBUTORE ZUCCHERO</i>
	44		11008685	SUGAR CAM <i>SUGAR CAM</i>
	45		1863.611	HARNESS <i>HARNESS</i>
	46		9111.683	SOLUBLE COVER <i>COPERCHIETTO SOLUBILI</i>
	47		9111.696	COVER SUGAR CONTAINER <i>COPERCHIO CONTENITORE ZUCCHERO</i>
	48		11004610	EXTENSION FOR CONTAINER SUGAR <i>PROLUNGAX CONTENITORE ZUCCHERO</i>
	49		9111.685	SUGAR CONTAINER <i>CONTENITORE ZUCCHERO</i>
	50		11032878	ШЕСТЕРНЯ КОНТЕЙНЕРА ДЛЯ ЦУКРУ (EX 9111.725) <i>CONTAINER WHEEL SUGAR BPA FREE</i>
	51		9111.726	SCROLL SCREW SUGAR CONTAINER <i>COCLEA CONTENITORE ZUCCHERO</i>
	52		11012130	BACK BUSH REINFORCE <i>BACK BUSH REINFORCE</i>
	53		NM03.013	OR 2,3X15 NBR <i>OR 2,3X15 NBR</i>
	54		9111.629.060	APERTURE FOR SOLUBLES HOPPER <i>APERTURE FOR SOLUBLES HOPPER</i>

## Model Machine

MACNEC023

OASI 400-600

	55		9111.630.060	BUSH FOR POWDERS TANK <i>BOCCOLA X SERBAT.POLVERI C/AGGANCI</i>
	56		9111.338.270	BULKHEAD FOR APERT. CLOSURE ORANGE <i>PARATIA CHIUSURA BOCCHETTA ARANCIO</i>
	57	 ПІД ЗАМОВЛЕННЯ	255027	SELF-TAPPING SCREW 3,9X6,5 <i>VITE AUTOFILETT. 3.9X6.5</i>
	58		9110.137	КОНТЕЙНЕР ДЛЯ ЦУКРУ SAECO <i>ASS. CONTENITORE ZUCCHERO</i>
	59		11005129	ASSEMBLY SUGAR CONTAINER <i>ASS.CONT.ZUCCHERO CON PROLUNGA</i>
	60	 ПІД ЗАМОВЛЕННЯ	262525	SUGAR/STIRRER DISTRIBUTOR ASSEMBLY -OASI 400- <i>SUGAR/STIRRER DISTRIBUTOR ASSEMBLY -OASI 400-</i>
	61	 ПІД ЗАМОВЛЕННЯ	262526	SUGAR/STIRRER DISTRIBUTOR ASSEMBLY -OASI 600- <i>SUGAR/STIRRER DISTRIBUTOR ASSEMBLY -OASI 600-</i>

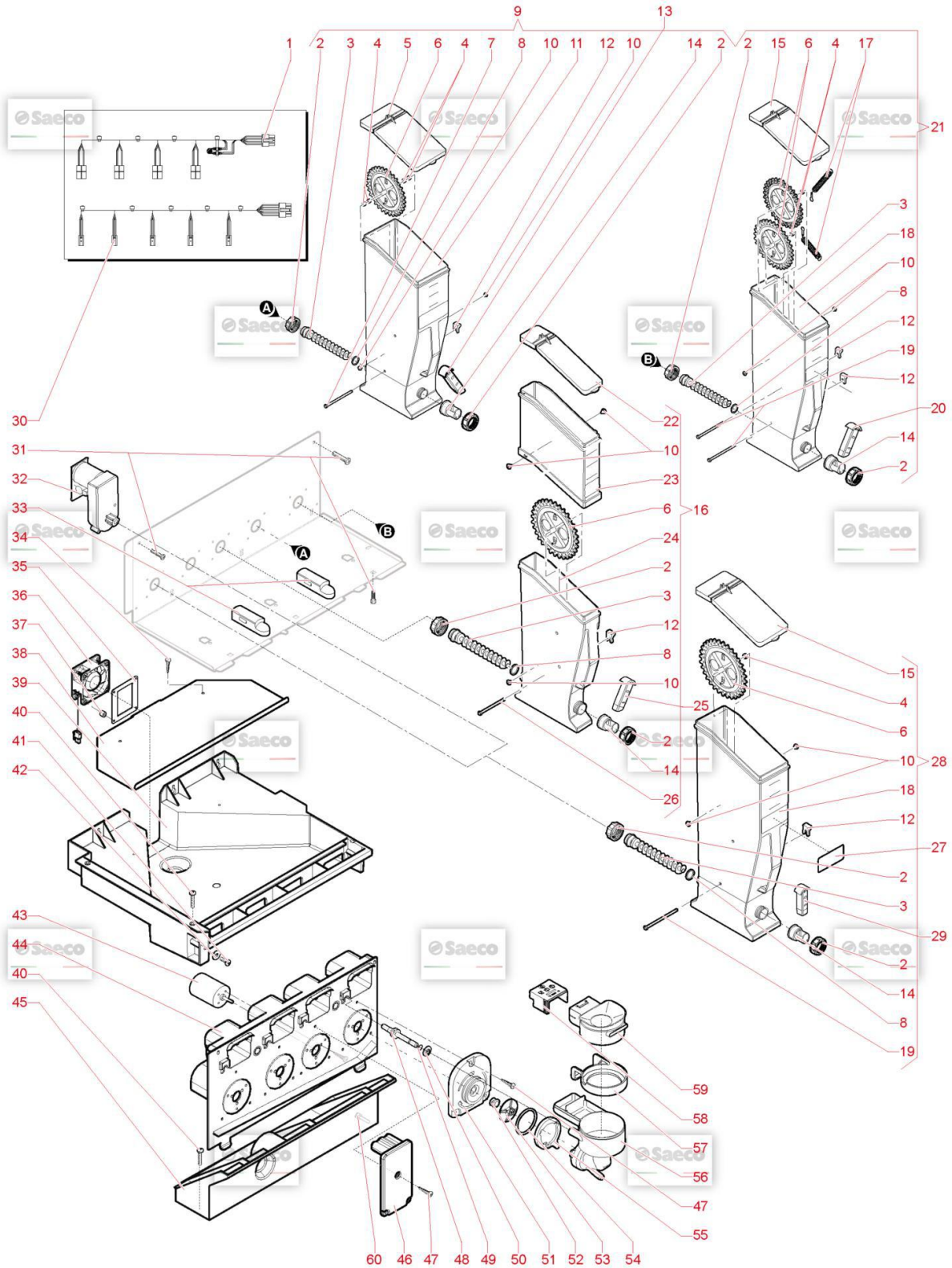



## Model Machine

MACNEC023

OASI 400-600

Web Pos. Foto Item - Replace by Description



Press - CTRL + CLICK go to item in a new window

Натисніть - Ctrl + права кнопка миші щоб відкрити запчастину в новому вікні



1



257704

WIRING BEATER WITH SHIELD  
CABLAGGIO FRULLINI CON PROTETTORE



2



254090

CONTAINER RING NUT  
GHIERA CONTENITORE



3



254085

SCROLL PITCH 30  
COCLEA PASSO 30



4



254094

SPACER  
DISTANZIALE



5

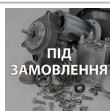

254096

LID FOR 6L CONTAINER  
COPERCHIO CONTENITORE 6L



6



254087

TOOTHED WHEEL  
RUOTA DENTATA



7

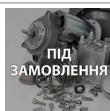

254097

6L CONTAINER WHEEL PIVOT  
PERNO RUOTA CONTENITORE 6L



8



257853

WASHER CONTAINER  
ROSETTA CONTENITORE



9

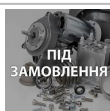

254214

6L CANISTER -1 WHEEL-  
CONTENITORE 6L -1 RUOTA-



10

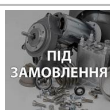

257518

CAP CONTAINER  
TAPPO CONTENITORI



11

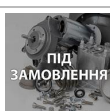

254095

6L CONTAINER CASING  
INVOLUCRO CONTENITORE 6L



12

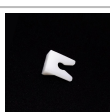

254089

PIN STOP  
FERMO PERNO



13















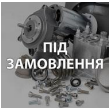













255279

ПРАВИЙ КОНВЕСЕР L=97MM НЕСТА  
CONVOGLIATORE DESTRO L=97MM

## Model Machine

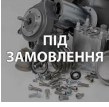
MACNEC023



OASI 400-600

	14		<b>254086</b>	POWDER PIPETTE <i>BOCCHETTA POLVERI</i>
	15		<b>254092</b>	LID FOR 4.5L CONTAINER <i>COPERCHIO CONTENITORE 4.5L</i>
	16		<b>254073</b>	2.5L CANISTER -1 WHEEL- <i>CONTENITORE 2.5L -1 RUOTA-</i>
	17		<b>254419</b>	BEATER SPRING <i>MOLLA SBATTITORE</i>
	18		<b>254091</b>	4.5L CONTAINER CASING <i>INVOLUCRO CONTENITORE 4.5L</i>
	19		<b>254093</b>	4.5L CONTAINER WHEEL PIVOT <i>PERNO RUOTA CONTENITORE 4.5L</i>
	20		<b>253996</b>	LEFT POWDER FEEDER L=120MM <i>CONVOGLIATORE SINISTRO L=120MM</i>
	21		<b>254215</b>	4.5L CANISTER -2 WHEELS-2 SPRINGS- <i>CONTENITORE 4.5L -2 RUOTE-2 MOLLE-</i>
	22		<b>254083</b>	LID FOR 2.5L CONTAINER <i>COPERCHIO CONTENITORE 2.5L</i>
	23		<b>254084</b>	2.5L UPPER CONTAINER CASING <i>INVOLUCRO CONTENITORE SUPERIORE 2.5L</i>
	24		<b>254082</b>	2.5L LOWER CONTAINER CASING <i>INVOLUCRO CONTENITORE INFERIORE 2.5L</i>
	25		<b>255280</b>	LEFT.HAND CONVEYOR L=97MM <i>CONVOGLIATORE SINISTRO L=97MM</i>
	26		<b>254088</b>	2.5L CONTAINER WHEEL PIVOT <i>PERNO RUOTA CONTENITORE 2.5L</i>
	27		<b>097502</b>	NAMEPLATE GROUP CONTAINER INSTANT P <i>GRUPPO TARGHETTE PER CONT.SOLUBILI</i>

## Model Machine

MACNEC023











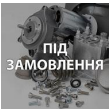

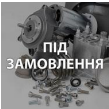

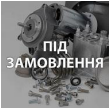

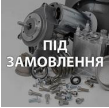

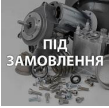

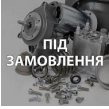

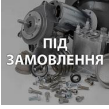

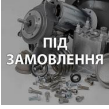

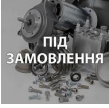
OASI 400-600

	28		254074	4.5L CANISTER -1 WHEEL- <i>CONTENITORE 4.5L -1 RUOTA-</i>
	29		253994	CENTRAL CONVEYOR -105MM- <i>CONVOGLIATORE CENTRALE -105MM-</i>
	30		255811	DOSER WIRING -ES- <i>CABLAGGIO DOSATORI -ES-</i>
	31		255493	SCREW M4X10 <i>VITE M4X10</i>
	32		254058	MOTORDOSER <i>MOTODOSATORE</i>
	33		254719	HEATED CONTAINER STOP <i>FERMO CONTENITORE RISCALDATO</i>
	34		255724	SELF-TAPPING SCREW 4X8 <i>VITE AUTOFIETT. 4X8</i>
	35		253997	FAN ADHESIVE SEAL <i>GUARNIZIONE ADESIVA VENTILATOR</i>
	36		262423	24 V FAN <i>24 V FAN</i>
	37		259397	SHIM <i>DISTANZIALE</i>
	38		262384	FAN SUPPORT <i>FAN SUPPORT</i>
	39		262417	SUCTION COMPARTMENT <i>SUCTION COMPARTMENT</i>
	40		255028	SELF-TAPPING SCREW 3,9X9,5 <i>VITE AUTOFIETT 3,9X9,5</i>

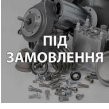
## Model Machine

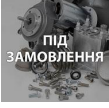
MACNEC023

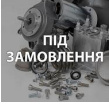











OASI 400-600

	41		259994	SCREW M3X30 SCREW M3X30
	42		092796	OUTFLOW REGUL FASTENER ROSETTA FERMO
	43		259398	BLENDER MOTOR MOTORE FRULLATORE
	44		262416	MIXER FRONT PLATE MIXER FRONT PLATE
	45		262418	BOTTOM MIXER PLATE BOTTOM MIXER PLATE
	46		254001	MIXER PLUG TAPPO MIXER
	47		258628	SELF-TAPPING SCREW. 4X15 VITE AUTOFIL. 4X15
	48		255787	MIXER NOZZLE D=2.3 9-11CC UGELLO MIXER D=2.3 9-11CC
	49		094611	GASKET O-RING 2018 GUARNIZIONE OR 2018
	50		39733800	ВТУЛКА МІКСЕРА 6 MM 6 MM 2,5 MM BOCCOLA FRULLATORE MIXER . ESTERNO 16 MM - . INTERNO 6 MM - SP...
	51		255821	MIXER FLANGE FLANGIA MIXER
	52		259612	ПРОКЛАДКА КОРИЧНЕВА GUARNIZIONE V RING-MARRONE
	53		253991	MIXER VENTILATOR VENTOLINA MIXER
	54		253985	GASKET OR 3137 GUARNIZIONE OR 3137

## Model Machine

MACNEC023

OASI 400-600

	55		253998	КІЛЬЦЕ ГАЙКА МІКСЕРА <i>GHIERA MIXER</i>
	56		259438	MIXER BODY <i>CORPO MIXER</i>
	57		255284	MIXER RING <i>ANELLO MIXER</i>
	58		259436	MIXER REAR COVER <i>COPERCHIO POSTERIORE MIXER</i>
	59		259437	MIXER FRONT COVER <i>COPERCHIO ANTERIORE MIXER</i>
	60		090148	CLIP <i>COLLARE</i>

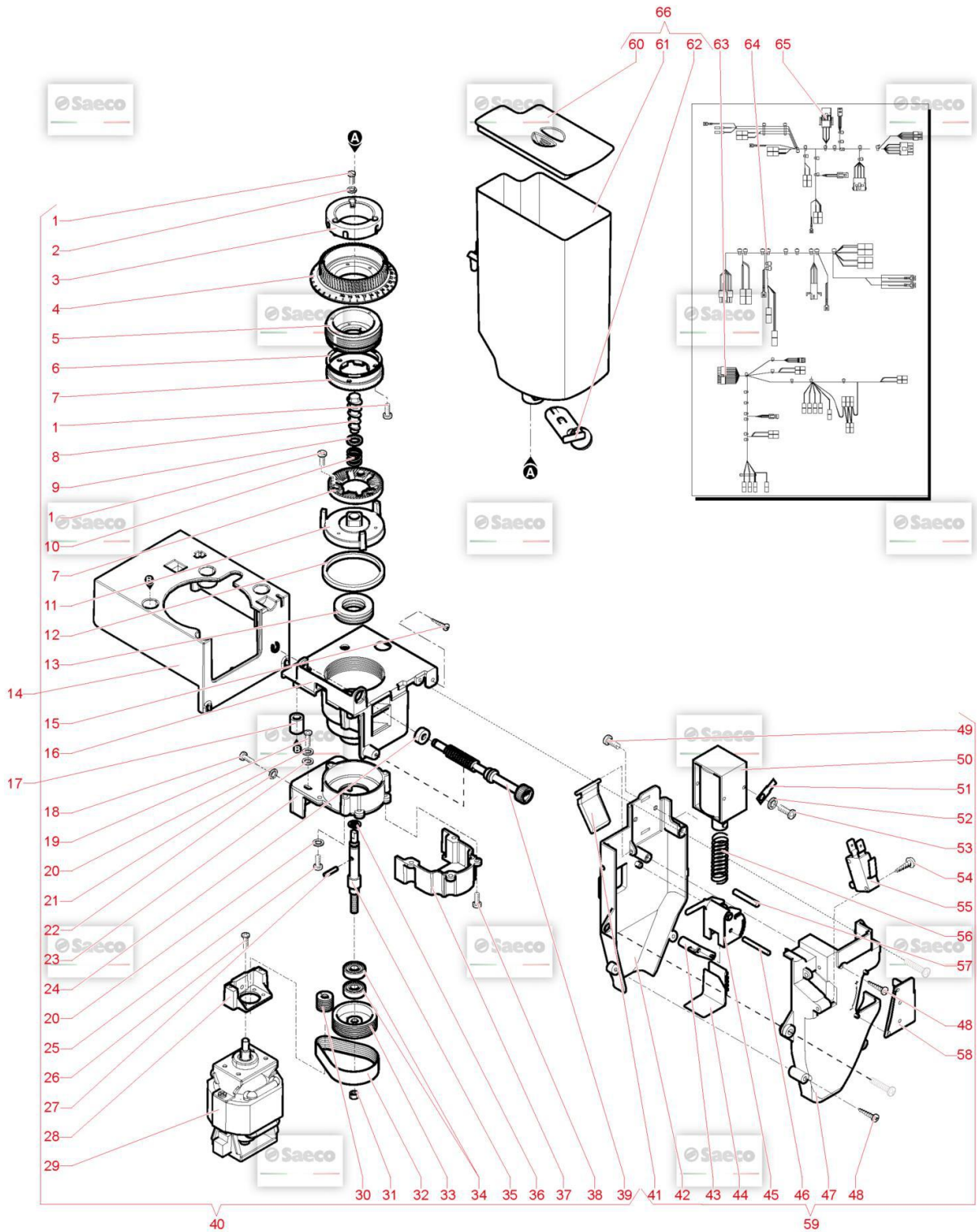

## Model Machine

MACNEC023

OASI 400-600

Web Pos. Foto Item - Replace by Description



Press - CTRL + CLICK go to item in a new window  
Натисніть - Ctrl + права кнопка миші щоб відкрити запчастину в новому вікні



1



U043.007

SCREW TCBC M3,0X8 UNI 7687 GALV.  
SCREW TCBC M3,0X8 UNI 7687 GALV.



2



U208.002

TOOTHED WASHER 3,3X5,8 UNI 3703 G  
ROSETTA DENT. 3,3X5,8 UNI 3703 ZNP



3



11032110

BUSH  
BUSH



4



1813.103.A20

RING NUT OF GRIND REGULATION  
RING NUT OF GRIND REGULATION



5



11025692

UPPER GRINDING DISK HOLDER "GRIND 48"  
UPPER GRINDING DISK HOLDER "GRIND 48"



6



12001617

OR 3206 NBR  
OR 3206 NBR



7



11021838

НИЖ КАВОМОЛКИ SAECO D-48 (1ШТ.)  
FLAT MILL D.47 TEA



8



11025695

ШНЕК БОЛТИК ЗБІЛЬШЕННЯ "MACINE 48"  
INCREASE SCREW "GRIND 48"



9



11027418

SPACER FOR SCREW OF INCREASE  
SPACER FOR SCREW OF INCREASE



10



11025694

SPRING "GRIND 48"  
SPRING GRIND 48



11



11025691

ТРИМАЧ НИЖНЬОГО НОЖА Д.48  
LOWER GRINDING DISK HOLDER GRIND 48



12



11027451

ПРОКЛАДКА DE=47,4 DI=41,4H=4 IN F  
ПРОКЛАДКА DE=47,4 DI=41,4H=4 IN F



13





























11025699

BEARING RTP 51104  
BEARING RTP 51104

## Model Machine

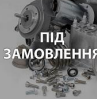
MACNEC023

OASI 400-600



























	14		11008262	GRIND SUPPORT <i>SUPPORTO MACININO GRIND SUPPORT</i>
	15		U116.006	SCREW AUT.PT TCB 3,5X12 WN 1441 ZNP <i>VITE AUT.PT TCB 3,5X12 WN 1441 ZNP</i>
	16		11027162	GRINDERS CAP D.48 <i>GRINDERS CAP D.48</i>
	17		1813.046.050	RUBBER GRIND SUPPORT <i>RUBBER GRIND SUPPORT</i>
	18		U023.004	SCREW TCEI M6,0X12 UNI 5931 GALV. <i>VITE TCEI M6,0X12 UNI 5931 Z</i>
	19		12002052	ZN-B TCB SCREW M4X16 <i>ZN-B TCB SCREW M4X16</i>
	20		128310404	МЕТАЛЕВЕ УБЧАСТЕ КОЛІЩАТКО UNI 8842 A4 <i>WASHER UNI 8842 A4 BURNISHED</i>
	21		U208.006	TOOTHED WASHER 6,4X11 UNI 3703 <i>ROSETTA DENT. 6,4X11 UNI 3</i>
	22		U207.004	PLAIN WASHER 4,3X16 UNI 6592 GAL <i>PLAIN WASHER 4,3X16 UNI 6592 GAL</i>
	23		11027164	MOTOR SUPPORT GRINDERS D.48 <i>MOTOR SUPPORT GRINDERS D.48</i>
	24		1813.159	ANTIVIBRATION RUBBER <i>ANTIVIBRATION RUBBER</i>
	25		12001700	SCREW TCB M4X30 UNI 7687 ZNP <i>SCREW TCB M4X30 UNI 7687 ZNP</i>
	26		12002039	SCREW TCBD TORX 20 M4X12 ZN-B <i>VITE TCBD TORX 20 M4X12 ZN-B</i>
	27		11025921	POWER PLUG UNI-EN 28743 D.3X14 <i>POWER PLUG UNI-EN 28743 D.3X14</i>



## Model Machine

MACNEC023











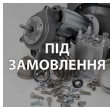

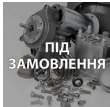

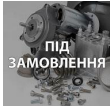

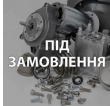

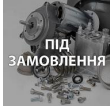



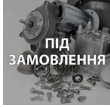

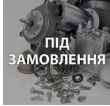

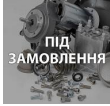
OASI 400-600

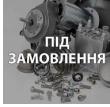
	28		11027163	MOTOR SUPPORT GRINDERS D.48 <i>MOTOR SUPPORT GRINDERS D.48</i>
	29		262435	MOTOR КОФЕМОЛКИ D.48 230V SAECO 11027396 <i>MOTORE MACINACAFFE' D.48 230V</i>
	30		11025690	PULLEY D.15 "GRIND 48" <i>PULLEY D.15 "GRIND 48"</i>
	31		U310.004	NUT SELF LOCK.M6 UNI 7473 <i>NUT SELF LOCK.M6 UNI 7473</i>
	32		11032130	BELT GRINDER COFFEE <i>BELT GRINDER COFFEE</i>
	33		11025689	PULLEY D.40 "GRIND 48" <i>PULLEY D.40 "GRIND 48"</i>
	34		11025696	BEARING RTP 608-2Z <i>BEARING RTP 608-2Z</i>
	35		11025693	CENTRAL PIN "GRIND 48" <i>CENTRAL PIN "GRIND 48"</i>
	36		140321662	O-RING 2021 SILICONE <i>OR 2021 IN SILICONE</i>
	37		11027186	ЧАСТИНА КРИПЛЕННЯ КАВМОЛКИ SAECO <i>SHELL CLOSURE BELT</i>
	38		129573402	SCREW TAPT M4X10 DIN 7985 GALV <i>SCREW TAPT M4X10 DIN 7985 GALV</i>
	39		1813.104.A20	ADJUSTMENT SCREW WITH TUBE HOLDER <i>VITE REGOLAZIONE MACININO</i>
	40		262434	COFFEE GRINDER ASS. <i>ASS. MACINACAFFE</i>

## Model Machine

MACNEC023























OASI 400-600

	41		<b>262456</b>	GREEN DOSER STIRRER <i>GREEN DOSER STIRRER</i>
	42		<b>11033266</b>	DISPENSER SHELL <i>GUSCIO INTERNO DOSATORE</i>
	43		<b>262459</b>	GREEN ADJUSTMENT LEVER <i>GREEN ADJUSTMENT LEVER</i>
	44		<b>262458</b>	GREEN REGULATOR STIRRER <i>GREEN REGULATOR STIRRER</i>
	45		<b>262457</b>	GREEN DOSER REGULATOR <i>GREEN DOSER REGULATOR</i>
	46		<b>1813.091</b>	PIN FOR DISPENSER REGULATION <i>PIN FOR DISPENSER REGULATION</i>
	47		<b>11033265</b>	OUTSIDE SHELL DISPENSER <i>GUSCIO ESTERNO DOSATORE</i>
	48		<b>12000390</b>	SCREW AUT.TCB 2,9X25 DIN 7981C NIK <i>SCREW AUT.TCB 2,9X25 DIN 7981 C NIK</i>
	49		<b>12002151</b>	TSP SCREW M3X4 UNI 7688 SS <i>TSP SCREW M3X4 UNI 7688 SS</i>
	50		<b>262463</b>	DOSER ELECTRO-MAGNET <i>ELETTROMAGNETE PER DOSATORE</i>
	51		<b>NE15.003</b>	MALE TONGUE PLAIN 6,3 D.5,2 <i>LINGUETTA MASCHIO PIANA 6,3 D.5,2</i>
	52		<b>128310404</b>	МЕТАЛЕВЕ УБЧАСТЕ КОЛІЩАТКО UNI 8842 A4 <i>WASHER UNI 8842 A4 BURNISHED</i>
	53		<b>129821402</b>	TCB SCREW M3X4 UNI 7687 ZNP <i>TCB SCREW M3X4 UNI 7687 ZNP</i>
	54		<b>U116.004</b>	SCREW AUT.PT TCB 3,0X16 WN 1441 <i>SCREW AUT.PT TCB 3,0X16 WN 1441</i>

## Model Machine

MACNEC023

OASI 400-600

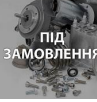
	55		NE05.062	MICROSWITCH + WHEEL <i>MICROINTERRUTTORE C/ROTELLA</i>
	56		1813.127	SPRING FOR ELECTROMAGNET <i>MOLLA X ELETTROMAGNETE DOSAT</i>
	57		1813.092	PIN <i>PIN</i>
	58		262461	GREEN DOSER COVER <i>GREEN DOSER COVER</i>
	59		262436	6-11 DOSER ASS. <i>ASS. DOSATORE 6-11</i>
	60		9111.728	COVER FOR COFFEE CONTAINER <i>COPERCHIO CONTENITORE CAFFE'</i>
	61		9111.724	CONTAINER FOR COFFEE BEAN <i>CONTENITORE CAFFE' IN GRANI</i>
	62		262433	COFFEE CONTAINER CLOSING SHUTTER <i>COFFEE CONTAINER CLOSING SHUTTER</i>
	63		262440	COF.GRIN. AND BOIL. LOW VOLT.WIR. <i>COF.GRIN. AND BOIL. LOW VOLT.WIR.</i>
	64		262439	DOS. GRIND.BOIL.HIGH VOLTAGE WIR. <i>DOS. GRIND.BOIL.HIGH VOLTAGE WIR.</i>
	65		262437	GRINDER AND DOSER WIR. <i>GRINDER AND DOSER WIR.</i>
	66		262432	COFFEE CONTAINER ASS. <i>COFFEE CONTAINER ASS.</i>

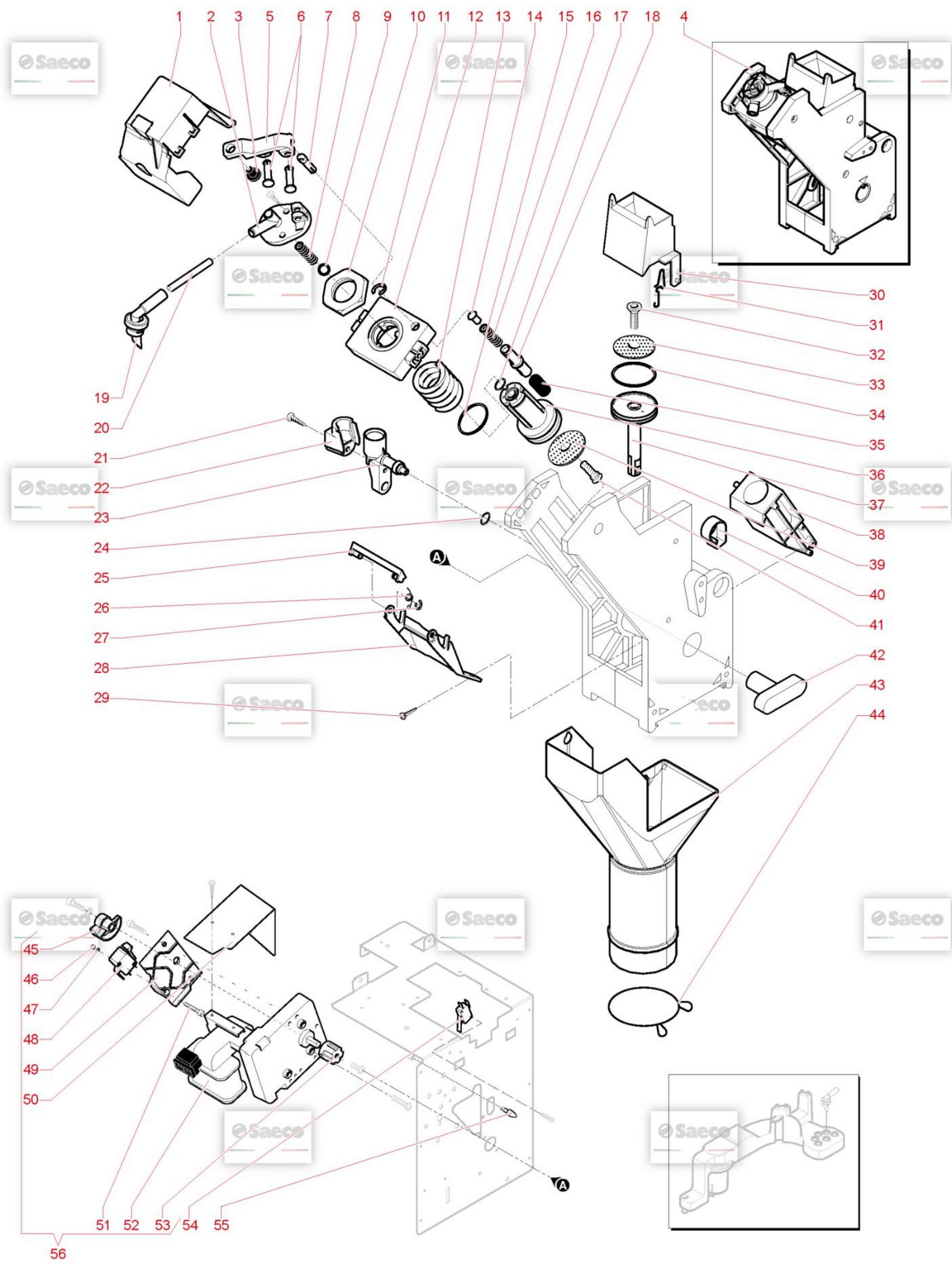

## Model Machine

MACNEC023

OASI 400-600

Web Pos. Foto Item - Replace by Description























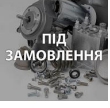





Press - CTRL + CLICK go to item in a new window  
Натисніть - Ctrl + права кнопка миші щоб відкрити запчастину в новому вікні

	1		11029737	PROTECTION VALVE <i>PROTEZIONE VALVOLA SFIATO GRUPPO CAFFE</i>
	2		11029311	COVER BALL VALVE <i>COPERCHIO VALVOLA SFERA</i>
	3		NV01.009	RUBBER BUFFER <i>GOMMINO PARACOLPI</i>
	4		11030408	BREWING UNIT ASS. 7GR GRAN GUSTO <i>ASS. GRUPPO CAFFE 6/8GR NEW</i>
	5		11029312	BREATHER VALVE CLOSED <i>CHIUSURA VALVOLA SFIATO</i>
	6		11030836	ШПЛИНТ ФІКСАЦІЇ СУППОРТУ КЛАПАНА <i>PIN FIXING VALVE SUPPORT</i>
	7		11029313	CURSOR COMPENSATOR VALVE VENT <i>CURSORE COMPENSATORE X VALVOLA SFIATO</i>
	8		126771918	SS COFFEE UNIT CONTERPISTON SPRING SMART <i>MOLLA CONTROPIST. GRUP. SMART INOX</i>
	9		12001811	SPHERE TEFLON D.4,5 <i>SFETA D.4.5 TEFLON X VALVOLA GRUPPO CAFF</i>
	10		11029317	NUT SEAL PISTON MOVABLE <i>DADO TENUTA CONTROPISTONE MOBILE</i>
	11		U701.007	ЕЛАСТИЧНЕ КІЛЬЦЕ 6 UNI 7434 (ЗАЛІЗО) <i>ЕЛАСТИЧНЕ КІЛЬЦЕ 6 UNI 7434 (ЗАЛІЗО)</i>
	12		11029316	FLANGE FOR CUPHOLDER <i>FLANGIA X PISTONE MOBILE</i>
	13		11029308	SPRING FOR MOVABLE COUNTERPISTON <i>MOLLA X CONTROPISTONE MOBILE</i>

## Model Machine

MACNEC023



























OASI 400-600

	14		9161.320	VALVE FOR UNIT VALVOLA X GRUPPO CAFFE'
	15		140322061	O-RING 4112 EPDM OR 4112 IN EPDM
	16		11029310	SPRING FOR RELIEF VALVE MOLLA COMPENSATRICE X VALVOLA SFIATO
	17		NM01.029	OR ORM 0100-15 SILICONE OR ORM 0100-15 SILICONE
	18		11029314	CURSOR FOR VALVE VENT CURSORE X VALVOLA SFIATO
	19		262393	COFFEE NOZZLE COFFEE NOZZLE
	20		254566	SILICONE HOSE 3X6 -BLUE- TUBO SILICONE BLU 3X6
	21		129512921	SCREW TCB TORX 10 AB 2,9X13 SHEET SS SCREW TCB TORX 10 2,9X13 SHEET SS
	22		11010013	CARTER FOR MUFF PREHEATING UNIT CARTE X MANICOTTO GRUPPO PRERISCALDO
	23		11005371	UNIT COFFEE MUFF MANICOTTO GRUPPO CAFFE' UNIT COFFEE MUFF
	24		140321462	O-RING 2018 SILICONE OR 2018 IN SILICONE
	25		9111.537.060	BROWN SCRAPER COFFEE GROUP BROWN SCRAPER COFFEE GROUP
	26		9111.520	SPRING FOR SCRAPER SECTION 0.6 SPRING FOR SCRAPER SECTION 0.6
	27		U701.006	ФІКСУЮЧА СКОБА 3,2 (ЗАПІЗО) SAECO ANELLO ELASTICO 3,2

## Model Machine

MACNEC023















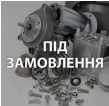











OASI 400-600

	28		9111.539.060	FORK FOR SCRAPER <i>FORCELLA PER RASCHIATORE</i>
	29		U110.013	БОЛТ МЕТАЛЕВИЙ 3,9X6,5 DIN 7981 F <i>SCREW AUT.TCB 3,9X6,5 DIN 7981 F</i>
	30		322001201	MOBILE SCRAPER BROWN NARROW <i>MOBILE SCRAPER BROWN NARROW</i>
	31		9161.425	SPRING FOR SCRAPER <i>SPRING FOR SCRAPER</i>
	32		129851921	TSP SCREW M3X6 UNI 7688 SS <i>TSP SCREW M3X6 UNI 7688 SS</i>
	33		324000200	SS PERCOLATOR D=34 FOR UNIT <i>SS PERCOLATOR D=34 FOR UNIT</i>
	34		140322500	ПРОКЛАДКА O-RING 2118 SH70 BIANCHI 36363116-01, SAECO 140322500 <i>OR 2118 IN NITRIL RUBBER</i>
	35		11029309	SPRING FOR RELIEF VALVE <i>MOLLA X VALVOLA SFIATO</i>
	36		11029878	ASS.CONTROPISTONE MOBILE <i>ASS.CONTROPISTONE MOBILE</i>
	37		11029879	ПОРШЕНЬ РОБОЧОГО БЛОКУ X 7 ГРАМ <i>ASS.PISTONE X GRUPPO CAFFE'</i>
	38		222711101	BROWN GROUND COFF.CONTAINER D=36 ASSY. <i>BROWN GROUND COFF.CONTAINER D=36 ASSY.</i>
	39		11012630	PERCOLATOR D.34 <i>PERCOLATOR D.34</i>
	40		11030309	RING FOR CAM <i>ANELLO X CAMMA PISTONE</i>

## Model Machine

MACNEC023

OASI 400-600

	41		<b>U044.009</b>	SS SCREW TSPC M3,0X8 UNI 7688 <i>VITE TSCP M3,0X8 UNI 7688 INO</i>
	42		<b>9161.021.060</b>	KEY FOR BREW UNIT BROWN <i>CHIAVE X GRUPPO CAFFE' MARRO</i>
	43		<b>262395</b>	GROUNDS DISCHARGE CHANNEL <i>GROUNDS DISCHARGE CHANNEL</i>
	44		<b>094048</b>	BAG LOCK COLLAR <i>BAG LOCK COLLAR</i>
	45		<b>11035504</b>	RATIOMOTOR CAM COFFEE GROUP <i>RATIOMOTOR CAM COFFEE GROUP</i>
	46		<b>U302.002</b>	NUT HEXAGONAL M3 UNI 5588 <i>NUT HEXAGONAL M3 UNI 5588</i>
	47		<b>U208.002</b>	TOOTHED WASHER 3,3X5,8 UNI 3703 G <i>ROSETTA DENT. 3,3X5,8 UNI 3703 ZNP</i>
	48		<b>NE05.066</b>	MICROSWITCH CHERRY D419Q1A <i>МИКРОПЕРЕМИКАЧ РЕДУКТОРА РОБОЧОЇ ГРУПИ</i>
	49		<b>11035503</b>	SUPPORT MICRO RATIOMOTOR <i>SUPPORT MICRO RATIOMOTOR</i>
	50		<b>11014251</b>	CENTRAL UNIT MOTOR STEEL CARTER <i>CENTRAL UNIT MOTOR STEEL CARTER</i>
	51		<b>U043.023</b>	SCREW TCBC M3,0X18 UNI 7687 GALV. <i>VITE TCBC M3,0X18 UNI 7687 ZNP</i>
	52		<b>11035557</b>	RATIOMOTOR 30 PLAST.P.F. 230/240-50 <i>MOTORID. PACCO 30 PLAST.P.F. 230/240-50</i>
	53		<b>11000103</b>	МЕТАЛЕВИЙ РЕГУЛЯТОР ДЛЯ МОТОРИДУКТОРА SAECO 9991.013 <i>GIUNTO X MOTORIDUTTORE V.2</i>
	54		<b>NE05.018</b>	MICROSWITCH <i>MICROINTERRUTTORE SAECO XCG5-81-P5</i>



## Model Machine

MACNEC023

OASI 400-600



55

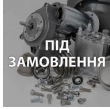

11006046

PEG FOR BOILER

*PEG FOR BOILER*



56

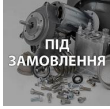

11036405

RATIOMOTOR FOR DA 230V

*RATIOMOTOR FOR DA 230V*