

Model Machine

MACSAE205

KABOBAPKA OCS SAE LIRIKA PLUS SIL 230/50 SCH (1000477)1000052

MACSAE205.T.0001



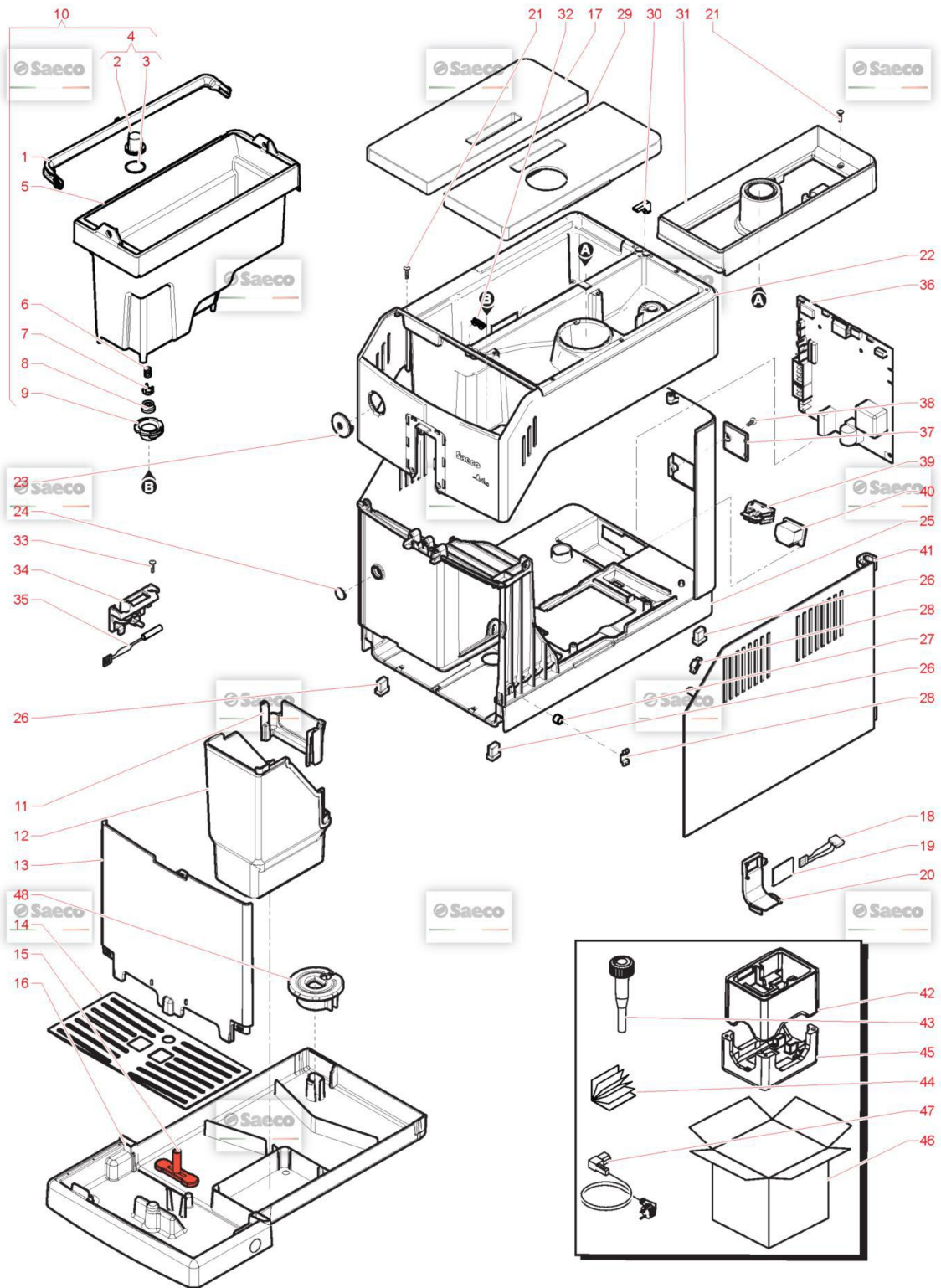











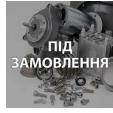





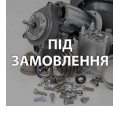



TAVOLA NR. 1 - ARTICOLO KABOBAPKA OCS SAE LIRIKA PLUS SIL 230/50 SCH (1000477)
1000052



Model Machine

MACSAE205

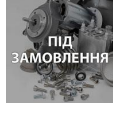

























КАВОВАРКА OCS SAE LIRIKA PLUS SIL 230/50 SCH (10004477)10000052

Web	Pos.	Foto	Item - Replace by	Description
				<i>Press - CTRL + CLICK go to item in a new window Натисніть - Ctrl + права кнопка миші щоб відкрити запчастину в новому вікні</i>
	1		11023155	BLACK WATER CONTAINER HANDLE MDS BLACK WATER CONTAINER HANDLE MDS
	2	 ПІД ЗАМОВЛЕННЯ	144650800	WHITE WATER CONTAINER EXT.FILTER WHITE WATER CONTAINER EXT.FILTER
	3		140328461	ПРОКЛАДКА O-RING 0190-10 ДЛЯ КОФЕМАШИНЫ PHILIPS SAECO 99653... OR METRICO 0190-10 IN EPDM NUOVO PREZZO 0,13
	4		224640200	БІЛИЙ ПЛАСТИКОВИЙ ФІЛЬТР У КОНТЕЙНЕР ВОДИ SAECO 996530029115 EXTERNAL FILTER FOR WATER CONTAINER ASSY
	5	 ПІД ЗАМОВЛЕННЯ	421944059661	TRANSP/GRY WATER CONTAINER V2SMRO TRANSP/GRY WATER CONTAINER V2SMRO
	6		11003672	SS SPRING FOR WATER CONTAIN.VALVE P0049 SPRING FOR WATER CONTAINER VALVE P0049
	7		421941157852	GRY WATER CONTAINER VALVE INSERT P0049 GRY WATER CONTAINER VALVE INSERT P0049
	8		11003671	РЕЗИНКА КЛАПАНУ БАКА ВОДИ P0049 SAECO GAGGIA PHILIPS 9965300... TRANSP.VALVE FOR WATER CONTAINER P0049
	9		17001366	BLACK LID FOR DUCKBILL VALVE SMR BLACK LID FOR DUCKBILL VALVE SMR
	10		421944060271	КОНТЕЙНЕР ВОДИ SAECO LIRIKA 421944059661 TRANSP/GRY WATER CONTAINER V2 SMRO ASSY
	11	 ПІД ЗАМОВЛЕННЯ	421944063131	BLK DUMP BOX INSERT V2 NPR BLK DUMP BOX INSERT V2 NPR
	12		421944060591	BLK DUMP BOX V2 SMR CAS.FONDI V2 SMR NER.

Model Machine

MACSAE205

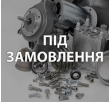

























КАВОВАРКА OCS SAE LIRIKA PLUS SIL 230/50 SCH (10004477)10000052

	13		421944014751	ФРОНТАЛЬНА СТИНКА ПІДДОНУ V2 SMR <i>CRC DRIP TRAY INSERT V2 SMR</i>
	14		421944031791	BA/SS GRATE FOR DRIP TRAY SMR/B-H-P <i>GRIGLIA VASCA REC.ACQ.SMR/B-H-P INOX/BA</i>
	15		421941304791	RED/3003 FLOAT FOR DRIP TRAY XSM <i>RED/3003 FLOAT FOR DRIP TRAY XSM</i>
	16	 ПІД ЗАМОВЛЕННЯ	17001568	MATT/BLACK DRIP TRAY SMR/B-H-P <i>MATT/BLACK DRIP TRAY SMR/B-H-P</i>
	17		421944015441	КРИШКА КОНТЕЙНЕРУ КАВИ СРІБЛЯСТА LID SMRO 421945004151 <i>CRC WATER CONTAINER LID SMRO</i>
	18	 ПІД ЗАМОВЛЕННЯ	421946035161	3P.CONN.WATER LEVEL V2 SMR ULASSY <i>AS.CONN.3P.LIVELLO ACQ.V2 SMR UL</i>
	19		11003232	AS.CPU+SW WATER LEVEL SENSOR V2 <i>AS.CPU+SW WATER LEVEL SENSOR V2</i>
	20		17001474	BLACK WATER LEVEL SENSOR SUPPORT SMR <i>BLACK WATER LEVEL SENSOR SUPPORT SMR</i>
	21		12001728	SCREW TCBR TORX 10 3,5X12 PLAST.SS <i>SCREW TCBR TORX 10 3,5X12 PLAST.SS</i>
	22	 ПІД ЗАМОВЛЕННЯ	421944027491	CRC UPP.CASING COVER V3 S/SCR.SMRO <i>CRC UPP.CASING COVER V3 S/SCR.SMRO</i>
	22	 ПІД ЗАМОВЛЕННЯ	421944027511	CRC UPP.CASING COVER V4 S/SCR.SMRO <i>CRC UPP.CASING COVER V4 S/SCR.SMRO</i>
	23		11031661	CRC FRONT PANEL CAP SMR <i>TAPPO FRONTALE PANEL CAP SMR</i>
	24	 ПІД ЗАМОВЛЕННЯ	11031523	BLACK INFRAREDS PLATE RYL <i>BLACK INFRAREDS PLATE RYL</i>
	25		421944063611	M/BLK CASING V3 SMR ASSY <i>AS.CARC.V3 SMR NER/OP.</i>

Model Machine

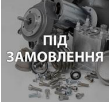
MACSAE205

















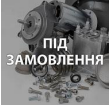





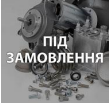

KABOBAPKA OCS SAE LIRIKA PLUS SIL 230/50 SCH (10004477)10000052

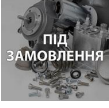
	26		17001556	TRANSP.SILICONE FOOT SMR <i>TRANSP.SILICONE FOOT SMR</i>
	27		9161.111	MAGNET FOR FLOAT SUPERAUT. <i>MAGNET FOR FLOAT SUPERAUT.</i>
	28		11013220	STEEL PLATE FOR DOOR MAGNET XSM <i>STEEL PLATE FOR DOOR MAGNET XSM</i>
	29		421944015421	CRC BEAN COF.CONT.LID SMRO <i>CRC BEAN COF.CONT.LID SMRO</i>
	29		421944024301	CRC BEAN COF.CONT.LID SMRO ASSY. <i>CRC BEAN COF.CONT.LID SMRO ASSY.</i>
	30		421944032481	BACK PLUG UPPER COVER CASING SMRO <i>BACK PLUG UPPER COVER CASING SMRO</i>
	31		421944059671	TRANSP/GRY BEAN COF.CONTAINERV3 SMRO <i>TRANSP/GRY BEAN COF.CONTAINER V3 SMRO</i>
	32		421944032361	FRONT PLUG UPPER COVER CASINGSMRO <i>FRONT PLUG UPPER COVER CASING SMRO</i>
	33		12000895	SCREW TSP TORX 10 3X10 PLAST.SS <i>SCREW TSP TORX 10 3X10 PLAST.SS</i>
	34		421944009421	BLK REED SUPPORT SMRO <i>BLK REED SUPPORT SMRO</i>
	35		17800442	2POLES CONNECT.SENSOR REED DUMP BOX CST <i>2POLES CONNECT.SENSOR REED DUMP BOX CST</i>
	36		421941306521	CPU+SW SMRO 120V ASSY. <i>AS.CPU+SW H2S1 SMRO 120V</i>
	36		421941306621	CPU+SW SMRO 100V ASSY. <i>CPU+SW SMRO 100V ASSY.</i>
	36		421941307781	CPU+SW H2S2 230V ASSY <i>AS. CPU+SW H2S2 230V</i>

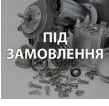
Model Machine

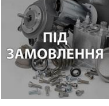
MACSAE205











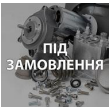

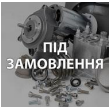

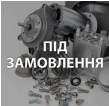











KABOBAPKA OCS SAE LIRIKA PLUS SIL 230/50 SCH (10004477)10000052

	37		17001484	MATT/BLK REAR CASING PROGRAM.INSERT NPR <i>MATT/BLK REAR CASING PROGRAM.INSERT NPR</i>
	38		129913202	SCREW TCB TORX 10 3X8 PLAST.ZN-B <i>SCREW TCB TORX 10 3X8 PLAST.ZN-B</i>
	39		242212625104	SWI POW 2P 12A 250V FASTON GP12H B <i>SWI POW 2P 12A 250V FASTON GP12H B</i>
	39		242212625106	SWI POW 2P 10A 250V FASTON 8500 B <i>SWI POW 2P 10A 250V FASTON 8500 B</i>
	40		12000280	CUP SOCKET EN 60320 C 13 <i>CUP SOCKET EN 60320 C 13</i>
	41		17001065	MATT/BLACK RIGHT SIDE DOOR SMR <i>MATT/BLACK RIGHT SIDE DOOR SMR</i>
	42		421944055261	PS-E UPPER INSERT FOR BOX SMRG/TE <i>PS-E UPPER INSERT FOR BOX SMRG/TE</i>
	43		11003785	BLACK GRINDER ADJUSTMENT KEY P0049 <i>CHIAVE REG.MACIN.CAF.P0049 NER 0049 BLACK GRINDER ADJUSTMEN...</i>
	44		421944060481	MANUAL SAE RI9841 V3 SMRO/P GB <i>MANUAL SAE RI9841 V3 SMRO/P GB</i>
	44		421944060491	MANUAL SAE RI9841 V3 SMRO/P KOR <i>MANUAL SAE RI9841 V3 SMRO/P KOR</i>
	44		421946004791	MANUAL SAE SUP041E SMRO/P CHN <i>MANUAL SAE SUP041E SMRO/P CHN</i>
	44		421946005701	MANUAL SAE SUP041E SMRO/P TWN <i>MANUAL SAE SUP041E SMRO/P TWN</i>
	44		421946027811	MANUAL SAE RI9841 V2 SMRO/P BRA <i>MANUAL SAE RI9841 V2 SMRO/P BRA</i>

Model Machine

MACSAE205

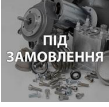









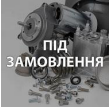

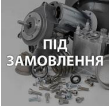





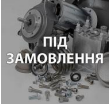

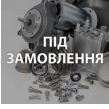
KABOBAPKA OCS SAE LIRIKA PLUS SIL 230/50 SCH (10004477)10000052

	44		421946041171	MANUAL SAE RI9841 V3 SMRO/P IT <i>MANUAL SAE RI9841 V3 SMRO/P IT</i>
	44		421946041181	MANUAL SAE RI9841 V3 SMRO/P DE <i>MANUAL SAE RI9841 V3 SMRO/P DE</i>
	44		421946041191	MANUAL SAE RI9841 V3 SMRO/P FR <i>MANUAL SAE RI9841 V3 SMRO/P FR</i>
	44		421946041201	MANUAL SAE RI9841 V3 SMRO/P ES <i>MANUAL SAE RI9841 V3 SMRO/P ES</i>
	44		421946041211	MANUAL SAE RI9841 V3 SMRO/P PT <i>MANUAL SAE RI9841 V3 SMRO/P PT</i>
	44		421946041221	MANUAL SAE RI9841 V3 SMRO/P NL <i>MANUAL SAE RI9841 V3 SMRO/P NL</i>
	44		421946041231	MANUAL SAE RI9841 V3 SMRO/P SV <i>MANUAL SAE RI9841 V3 SMRO/P SV</i>
	44		421946041241	MANUAL SAE RI9841 V3 SMRO/P PL <i>MANUAL SAE RI9841 V3 SMRO/P PL</i>
	44		421946041251	MANUAL SAE RI9841 V3 SMRO/P RU <i>MANUAL SAE RI9841 V3 SMRO/P RU</i>
	44		421946041261	MANUAL SAE RI9841 V3 SMRO/P HU <i>MANUAL SAE RI9841 V3 SMRO/P HU</i>
	44		421946041271	MANUAL SAE RI9841 V3 SMRO/P CS <i>MANUAL SAE RI9841 V3 SMRO/P CS</i>
	44		421946041281	MANUAL SAE RI9841 V3 SMRO/P SK <i>MANUAL SAE RI9841 V3 SMRO/P SK</i>
	44		421946041291	MANUAL SAE RI9841 V3 SMRO/P RO <i>MANUAL SAE RI9841 V3 SMRO/P RO</i>
	44		421946041301	MANUAL SAE RI9841 V3 SMRO/P BG <i>MANUAL SAE RI9841 V3 SMRO/P BG</i>

Model Machine

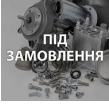
MACSAE205

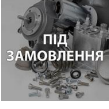
КАВОВАРКА OCS SAE LIRIKA PLUS SIL 230/50 SCH (10004477)10000052

	45		13001671	PS-E LOWER INSERT FOR BOX SMR <i>INS.INF.SCAT.SMR PS-E</i>
	46		421940312311	WHT EXTERNAL BOX SMRO SAE LIRIKA <i>WHT EXTERNAL BOX SMRO SAE LIRIKA</i>
	47		11001985	BLACK POWER CABLE KOREA L=1200 <i>BLACK POWER CABLE KOREA L=1200</i>
	47		11004247	BLACK POWER CABLE RVV 3X1 CHINA L=1200 <i>BLACK POWER CABLE RVV 3X1 CHINA L=1200</i>
	47		17800019	BLACK POWER CABLE BRAZIL L=1200 <i>BLACK POWER CABLE BRAZIL L=1200</i>
	47		17800024	BLACK POWER CABLE JAPPON VCTFL=1200MM <i>BLACK POWER CABLE JAPPON VCTF L=1200MM</i>
	47		183911050	ЧОРНИЙ КАБЕЛЬ SCHUKO L=1200 SAECO <i>BLACK POWER CABLE SCHUKO L=1200</i>
	47		183921950	POWER CABLE SJT3 USA BLACK ULL=1200 <i>POWER CABLE SJT3 USA BLACK UL L=1200</i>
	47		421946041821	BLK POWER CABLE TAIWAN V2 HVCTF L=1200 <i>BLK POWER CABLE TAIWAN V2 HVCTF L=1200</i>
	47		NE01.093	CABLE ARGENTINA + PLUG EN60320C13 <i>CABLE ARGENTINA + PLUG EN60320 C13</i>
	48		17000674	BLACK WATER DRAINAGE CONVEYORSMR/B-T <i>BLACK WATER DRAINAGE CONVEYOR SMR/B-T</i>

Model Machine

MACSAE205

KABOBAPKA OCS SAE LIRIKA PLUS SIL 230/50 SCH (1000477)1000052

MACSAE205.T.0002

TAVOLA NR. 2 - ARTICOLO KABOBAPKA OCS SAE LIRIKA PLUS SIL 230/50 SCH (1000477)
1000052

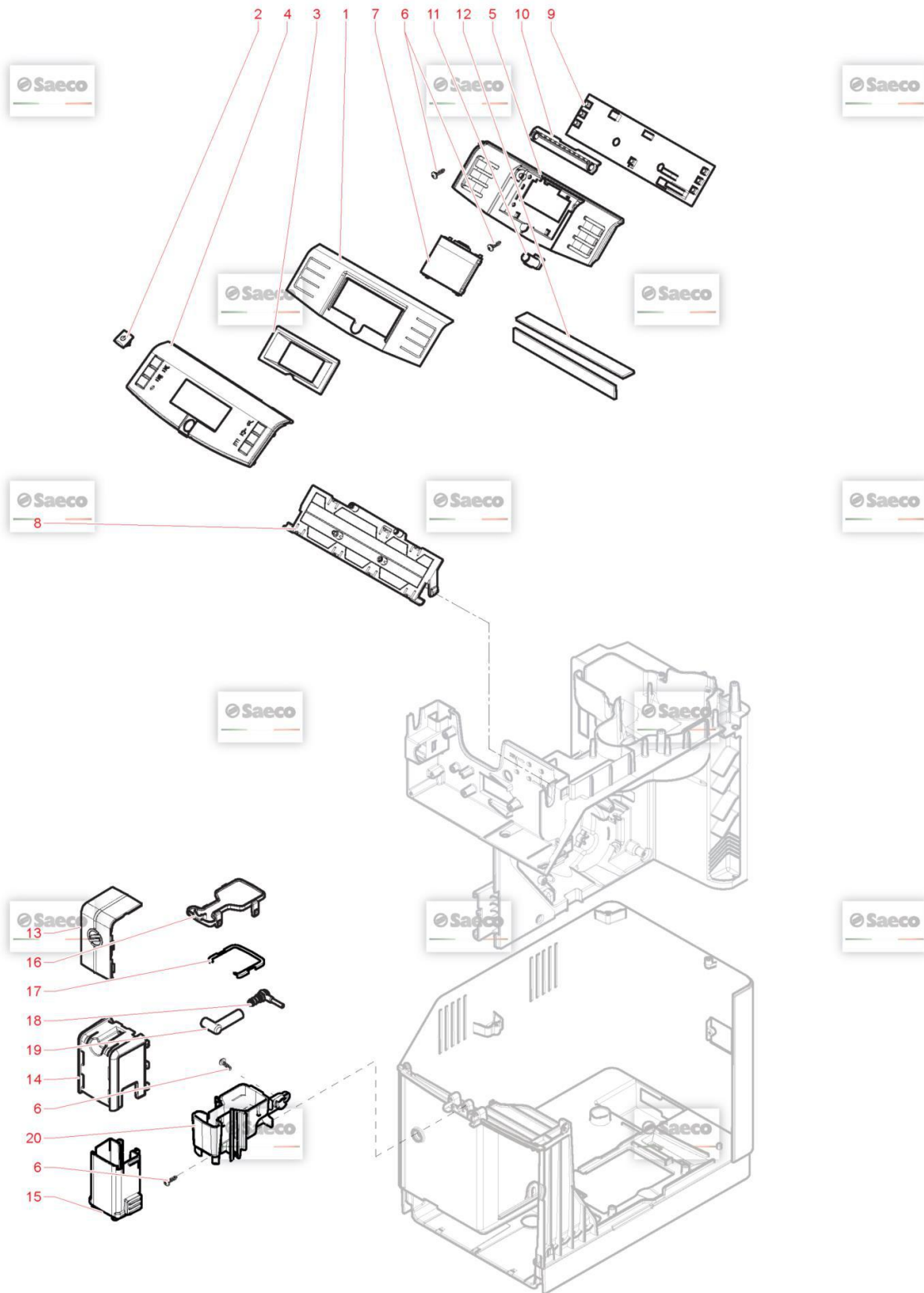

Model Machine

MACSAE205

КАВОВАРКА OCS SAE LIRIKA PLUS SIL 230/50 SCH (10004477)10000052

Web Pos. Foto Item - Replace by Description



*Press - CTRL + CLICK go to item in a new window
Натисніть - Ctrl + права кнопка миші щоб відкрити запчастину в новому вікні*



1



421944025241

BLK FRONT PANEL MEMBRANE V3 SMR/H-P-T
BLK FRONT PANEL MEMBRANE V3 SMR/H-P-T



2



421944009351

TRANSP.STAND-BY BUTTON S/SCR.SMRO
TASTO STAND-BY SMRO TRASP.SER.



3

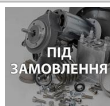

17001270

BLACK DISPLAY FRAME SMR
BLACK DISPLAY FRAME SMR



4

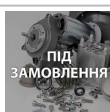

421944012351

SS DISPLAY FRONT PANEL S/SCR.SMRO/P ASSY
SS DISPLAY FRONT PANEL S/SCR.SMRO/P ASSY



5



421944017321

BLK DISPLAY SUPPORT V2 SMR/H-P-T ASSY.
BLK DISPLAY SUPPORT V2 SMR/H-P-T ASSY.



6



12000450

SCREW TCBR TORX 10 3,5X12 PLAST.ZN-N
SCREW TCBR TORX 10 3,5X12 PLAST.ZN-N



7



421941300941

DISPLAY LCD 128X64 SMR
DISPLAY LCD 128X64 SMR



8

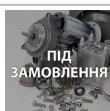

17000704

BLACK DISPLAY KEYBOARD SUPPORTSMR
BLACK DISPLAY KEYBOARD SUPPORT SMR



9

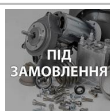

421941303001

KYB - DISPLAY SMR/H 230V
KYB - DISPLAY SMR/H 230V



9

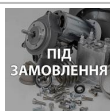

421941303571

KYB - DISPLAY SMR/H 120V
KYB - DISPLAY SMR/H 120V



10

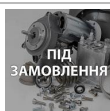

17001253

BLK FRONT.PANEL MEMBRANE SUPP.SMR/H-P-T
BLK FRONT.PANEL MEMBRANE SUPP.SMR/H-P-T



11



17002075

WHITE STAND-BY BUTTON LIGHT GUIDE SMR
WHITE STAND-BY BUTTON LIGHT GUIDE SMR



12

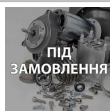











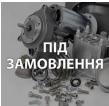









421944008251

BLK ADH.AERSTOP SMR
BLK ADH.AERSTOP SMR

Model Machine

MACSAE205















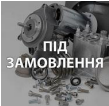











КАВОВАРКА OCS SAE LIRIKA PLUS SIL 230/50 SCH (10004477)10000052

	13		421944031761	BA SS COF.DISPENS.FRONT PLATECOVER SMR <i>BA SS COF.DISPENS.FRONT PLATECOVER SMR</i>
	14		17002059	ВЕРХНЯ ЧАСТИНА ЛІЙКИ ВИДАЧИ КАВИ <i>OP.EROG.CAF.SMR NER/OP.</i>
	15		421944008261	M/BLK COF.DISPEN.MOBILE PART SMR ASSY. <i>M/BLK COF.DISPEN.MOBILE PART SMR ASSY.</i>
	15		421944065141	M/BLK COF.DISPEN.MOBILE PART V2 SMR <i>M/BLK COF.DISPEN.MOBILE PART V2 SMR</i>
	16		421944017631	ВЕРХНЯ ЧОРНА КРИШКА ДІСПЕНСОРА ВИДАЧИ КАВИ <i>BLK COFFEE DISPENSER BODY LID V3 SMR</i>
	17		421944017651	WHT COFFEE DISPENSER BODY SEALSMR <i>WHT COFFEE DISPENSER BODY SEAL SMR</i>
	18		17001849	BLK BREW UNIT COFFEE OUTLET CONNECT.SMR <i>BLK BREW UNIT COFFEE OUTLET CONNECT.SMR</i>
	19		17000955	TRANS.BREW UNIT COF.OUTLET CONN.TUBE SMR <i>TRANS.BREW UNIT COF.OUTLET CONN.TUBE SMR</i>
	19		421944065131	TRASP.SIL.COFFEE DISPENSER TUBE SMR <i>TUBO EROG.CAF.SMR SIL.TRASP.</i>
	20		17001022	BLACK COFFEE DISPENSER BODY SMR <i>BLACK COFFEE DISPENSER BODY SMR</i>
	20		421944065151	BLK COFFEE DISPENSER BODY V3 SMR <i>CORPO EROG.CAF.V3 SMR NER.</i>

Model Machine

MACSAE205

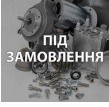









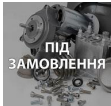



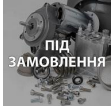



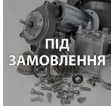



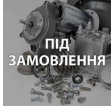

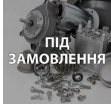

КАВОВАРКА OCS SAE LIRIKA PLUS SIL 230/50 SCH (10004477)1000052

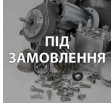
Web	Pos.	Foto	Item - Replace by	Description
				<i>Press - CTRL + CLICK go to item in a new window Натисніть - Ctrl + права кнопка миші щоб відкрити запчастину в новому вікні</i>
	1		421941301142	BLK STEAM TUBE INSERT V2 SMR/H BLK STEAM TUBE INSERT V2 SMR/H
	2	 ПІД ЗАМОВЛЕННЯ	421941301121	BLK CAPPUC.CASING COVER RING SMR/H BLK CAPPUC.CASING COVER RING SMR/H
	3		421941301131	BLK CAPPUC.CASING SEAL SMR/H BLK CAPPUC.CASING SEAL SMR/H
	4		147922350	BLACK CONNECTOR 90° FOR SPHERIC.CAPPUC. BLACK CONNECTOR 90° FOR SPHERIC.CAPPUC.
	5		9972.045	SILICONE TUBE 3,5X6 L=350 MM DS TUBO SILICONE 3,5X6 L.350 MM
	6	 ПІД ЗАМОВЛЕННЯ	421944023812	BLK CAPPUC.CASING COVER V5 SMR/H ASSY. AS.COP.CORPO CAPPUC.V5 SMR/H NER.
	7		NM01.028	O-RING 106 SILICONE OR 106 SILICONE
	8	 ПІД ЗАМОВЛЕННЯ	421944022461	BLK CAPPUC.CASING V3 SMR/H CORPO CAPPUC.V3 SMR/H NER.
	9		421944023801	ЧОРНИЙ КАПУЧИНАТОР V3 S/SCR.NPR/H (3 ТРУБКОЮ) AS.CAPPUC.V3 SMR/H NER.
	10		12000892	ЗАЖИМ D.9,5 16700004 OETIKER CLAMP D=9,5 16700004 (L250)
	11		11023153	SLIM TUB.BOILER 1300W 120V ASSY. SLIM TUB.BOILER 1300W 120V ASSY.
	11	 ПІД ЗАМОВЛЕННЯ	11024193	SLIM TUB.BOILER 1100W 100V ASSY. SLIM TUB.BOILER 1100W 100V ASSY.
	11		17000346	HP/SLIM TUB.BOILER 1900W 230V ASSY. AS.CALD.TUB.SLIM/HP 1900W 230V

Model Machine

MACSAE205























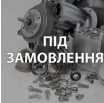

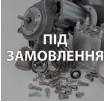
КАВОВАРКА OCS SAE LIRIKA PLUS SIL 230/50 SCH (10004477)10000052

	12		12001715	SCREW TCB TORX 20 M4X8 AUTOFORMING ZN-B <i>SCREW TCB TORX 20 M4X8 AUTOFORMING ZN-B</i>
	13		17800628	TEMPERATURE SENSOR NTC UL L=550MM <i>TEMPERATURE SENSOR NTC UL L=550MM</i>
	14		11001751	TUB.BOILER V3 UPPER THERM.FIXING SPRING <i>TUB.BOILER V3 UPPER THERM.FIXING SPRING</i>
	15		12001033	ТЕРМОСТАТ 190°С БОЙЛЕРА ДЛЯ КОФЕВАРОК PHILIPS SAECO 12001033 <i>THERMOSTAT ONE SHOT 190°</i>
	16		12001280	SCREW TSP TORX 10 5X20 PLAST.ZN-B <i>SCREW TSP TORX 10 5X20 PLAST.ZN-B</i>
	16		12001369	SCREW TSP TORX 10 5X35 PLAST.SS <i>SCREW TSP TORX 10 5X35 PLAST.SS</i>
	17		421944010421	SLIM TUB.BOILER SMR 1300W 120VASSY. <i>SLIM TUB.BOILER SMR 1300W 120VASSY.</i>
	17		421944024221	SLIM TUB.BOILER SMR 1100W 100VASSY. <i>SLIM TUB.BOILER SMR 1100W 100VASSY.</i>
	17		421944051651	HP/SLIM TUB.BOILER V2 SMR 1900W 230V AS. <i>HP/SLIM TUB.BOILER V2 SMR 1900W 230V AS.</i>
	18		421944040831	BLK SLIM TUB.BOILER SUPPORT V2SMR <i>BLK SLIM TUB.BOILER SUPPORT V2 SMR</i>
	19		12000450	SCREW TCB TORX 10 3,5X12 PLAST.ZN-N <i>SCREW TCB TORX 10 3,5X12 PLAST.ZN-N</i>
	20		16000380	5X8,9 SILICONE TUBE IN ROLL <i>5X8,9 SILICONE TUBE IN ROLL</i>
	21		11030926	ХРОМОВАНА ТРУБКА ДЛЯ ВОДИ/ПАРУ <i>TF/CHROM.STEAM TUBE SMR ASSY.</i>
	22		17001029	ОПОРА ТРУБКИ ПАРИ PHILIPS SAECO 996530073457 <i>STEAM TUBE SUPPORT SMR</i>

Model Machine

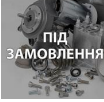
MACSAE205

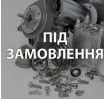
KABOBAPKA OCS SAE LIRIKA PLUS SIL 230/50 SCH (10004477)10000052

	23		17001028	BLACK BUSH FOR STEAM TUBE SMR <i>BLACK BUSH FOR STEAM TUBE SMR</i>
	24		140324461	OR ORM 0060-20 TERMOIL <i>OR ORM 0060-20 IN TERMOIL</i>
	25		421941300671	BLK/SIL.STEAM TUBE HANDGRIP G0053 <i>BLK/SIL.STEAM TUBE HANDGRIP G0053</i>
	26		11001620	BLACK PANNARELLO INNER TUBE P0049 <i>BLACK PANNARELLO INNER TUBE P0049</i>
	27		11001621	SS PANNARELLO COVER P0049 <i>STAINLESS STEEL PANNARELLO COVER P0049</i>
	28	 ПІД ЗАМОВЛЕННЯ	421941279742	BLK CONNECTOR FOR PIN BOILER V2 SMR <i>RAC.PERNO CALD.SMR NER.</i>
	29	 ПІД ЗАМОВЛЕННЯ	16000540	TRANSPAR.11X12,8 SILICONE TUBEIN ROLL <i>TRANSPAR.11X12,8 SILICONE TUBE IN ROLL</i>
	30	 ПІД ЗАМОВЛЕННЯ	11002149	BLACK PUMP OUTLET 90°CONNECTORP0049/A <i>BLACK PUMP OUTLET 90°CONNECTOR P0049/A</i>
	31		JS01.022	SILICONE TUBE 5X10 60SH IN ROLL <i>SILICONE TUBE 5X10 60SH IN ROLL</i>
	32		149205850	BLACK TYPE ULKA PUMP W/BEVEL SUPPORT <i>BLACK TYPE ULKA PUMP W/BEVEL SUPPORT</i>
	33	 ПІД ЗАМОВЛЕННЯ	12000130	ULKA PUMP EP5/S GW 100V-50/60HZ <i>ULKA PUMP EP5/S GW 100V-50/60HZ</i>
	33	 ПІД ЗАМОВЛЕННЯ	12000140	PUMP 230V-50HZ <i>ULKA PUMP EP5/S GW 230V-50HZ</i>
	33	 ПІД ЗАМОВЛЕННЯ	12000142	POMPE 120V-60HZ <i>ULKA PUMP EAP5/S 120V-60HZ</i>

Model Machine

MACSAE205

КАВОВАРКА OCS SAE LIRIKA PLUS SIL 230/50 SCH (10004477)10000052



33

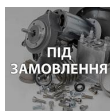

12000182

ULKA PUMP EP5/S GW 220V-60HZ

ULKA PUMP EP5/S GW 220V-60HZ



33

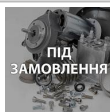

421944081531

ULKA PUMP EFP5/S 120V-60HZ

ULKA PUMP EFP5/S 120V-60HZ



34



11024863

L-F/BR.SAFETY VALVE 16-18 BAR ASSY.

AS.VALV.SIC.16-18 BAR OT/L-F



35



11024039

3WAY EV OT57 (31JN1XRV20-SXT+LBV05024CU)

3WAY EV OT57 (31JN1XRV20-SXT+LBV05024CU)



36



11024868

L-F/BRASS CONNECT.FOR ALUM.BOILER

L-F/BRASS CONNECT.FOR ALUM.BOILER



37



129823802

TCB SCREW M4X8 UNI 7687 ZNP

VITE TCB M4X8 UNI 7687 ZNP



38



11031400

L-F/BRASS 90°CONNECTOR V2 FOR FAUCET EV.

L-F/BRASS 90°CONNECTOR V2 FOR FAUCET EV.



39



17001269

L-F/BRASS 90°CONNECT.FOR FAUCET EV.NPR/T

L-F/BRASS 90°CONNECT.FOR FAUCET EV.NPR/T



40



11024038

BRASS 2WAY EV 21JN1RRV20-XT+LBV05024CU

BRASS 2WAY EV 21JN1RRV20-XT+LBV05024CU



41

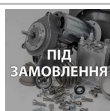

0701.081

SPRING FOR TUBE PRODUCT 1

SPRING FOR TUBE PRODUCT 1



42



17800686

3POLES CONNECTOR FLOWMETER SMRUL

AS.CONN.3P.TURBINA SMR UL



43



NV99.099

TURBINE D=1,2 ASSY.

TURBINA DIGMESA FHKSC 1,2 ARNITE OC



44

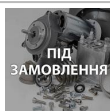

17001060

BLACK WATER DRAINAGE CONNECTORS MR/B-T

BLACK WATER DRAINAGE CONNECTOR SMR/B-T

Model Machine

MACSAE205

KABOBAPKA OCS SAE LIRIKA PLUS SIL 230/50 SCH (1000477)1000052

MACSAE205.T.0004



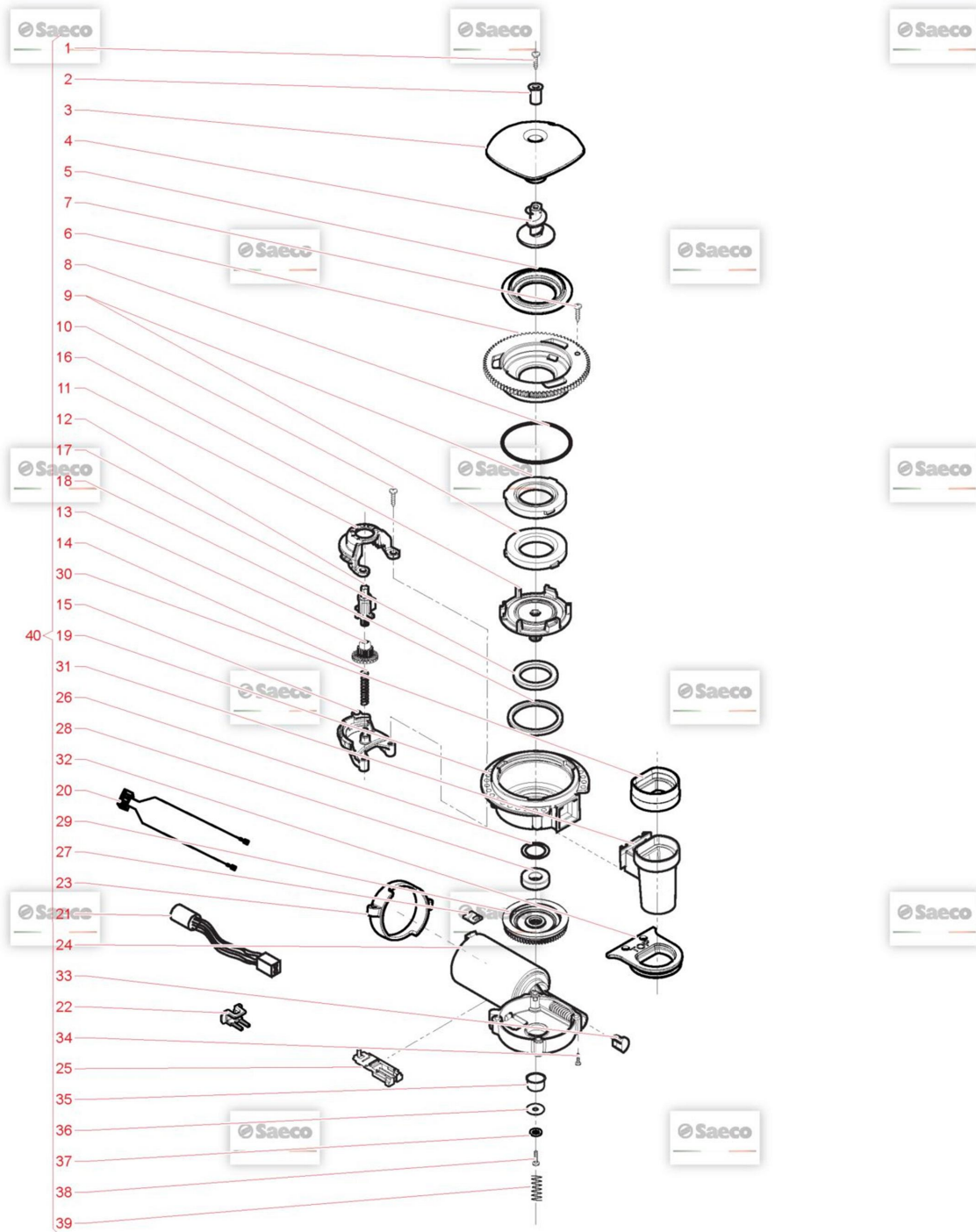























TAVOLA NR. 4 - ARTICOLO KABOBAPKA OCS SAE LIRIKA PLUS SIL 230/50 SCH (1000477) 1000052

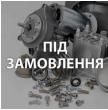

Model Machine

MACSAE205























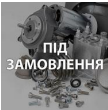



КАВОВАРКА OCS SAE LIRIKA PLUS SIL 230/50 SCH (10004477)10000052

Web	Pos.	Foto	Item - Replace by	Description
				<i>Press - CTRL + CLICK go to item in a new window Натисніть - Ctrl + права кнопка миші щоб відкрити запчастину в новому вікні</i>
	1		U043.004	ZN-B TCB TORX 20 M4X16 ZN-B VITE TCBC M4,0X16 UNI 7687 ZNP
	2		11012466	ЛАТУННА ВТУЛКА БУНКЕРУ P0057 BRASS BUSH BEAN CONT.FINGER PROTEC.P0057
	3		17001008	TRANS.BEAN CONTAIN.FINGER PROTECT.SMR UL TRANS.BEAN CONTAIN.FINGER PROTECT.SMR UL
	4		11010031	ЗМІЄВИДНИЙ ГВИНТ ДЛЯ КОВОМОЛКИ TEA/ZAMA INCREASE SCREW GRINDER
	5		421941085872	УПЛОТНИТЕЛЬ ДЛЯ КОФЕВАРКИ (КОФЕМАШИНЫ) SAECO PHILIPS P119... COFFEE GRINDER SEAL P119 GRY 7035
	6		421944053581	BLK COF.GRINDER UPPER GRINDERSUPPORT V3 BLK COF.GRINDER UPPER GRINDERSUPPORT V3
	7		12001622	SCREW TCB TORX B 3,5X9,5 SCHEET NIK SCREW TCB TORX B 3,5X9,5 SCHEET NIK
	8		140328960	OR ORM 0530-15 NBR FDA OR ORM 0530-15 NBR FDA
	9		146520100	BAKED CLAY GRINDER 48X28 BAKED CLAY GRINDER 48X28
	10		129914002	SCREW TCB TORX 10 3,5X16 PLAST.ZN-B SCREW TCB TORX 10 3,5X16 PLAST.ZN-B
	11		11002508	UPPER COFFEEGRINDER GEAR SUPPORT P124 UPPER COFFEEGRINDER GEAR SUPPORT P124
	12		421944025161	ЧОРНИЙ ПЛАСТИКОВИЙ РЕГУЛЯТОР КАВОВОЛКИ SAECO 11003446 YLW BEAN COFFEE GRINDER INSERT SMR
	13		11003784	COFFEE GRINDING ADJUSTMENT GEAR P0049 COFFEE GRINDING ADJUSTMENT GEAR P0049

Model Machine















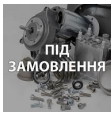







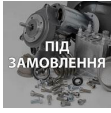

MACSAE205

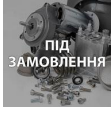
KABOBAPKA OCS SAE LIRIKA PLUS SIL 230/50 SCH (10004477)10000052

	14		11002572	COFFEEGRINDER REGULATION SPRING P124 <i>COFFEEGRINDER REGULATION SPRING P124</i>
	15		11002613	LOWER COFFEEGRINDER GEAR SUPPORT P124 <i>LOWER COFFEEGRINDER GEAR SUPPORT P124</i>
	16		149198350	BLK LOWER COFFEEGRINDER GRINDER SUPPORT <i>LOWER GRINDER SUPPORT COFFEEGRINDER</i>
	17		123030300	AXIAL BEARING EKKO 342.35252 <i>AXIAL BEARING EKKO 342.35252</i>
	18		140360500	FELT RING 45,4X39,4X4 <i>FELT RING 45,4X39,4X4</i>
	19		142905450	ЗОВНІШНЯ ПЛАСТИКОВА ЧАСТИНА ДВИГУНА ГОРИЗОНТАЛЬНОЇ КАВО... <i>BLK UPPER BODY WITH COFFEE GROUND OUTLET</i>
	20		421946000941	2P.CONN.COF.GRIND.MOTOR FUSE1.0A SMRO UL <i>2P.CONN.COF.GRIND.MOTOR FUSE1.0A SMRO UL</i>
	20		421946004841	2P.CONN.COF.GRIND.MOTOR FUSE1.6A SMRO UL <i>AS.CONN.2P.MOTORE MC FUS.1.6A SMRO UL</i>
	20		421946010741	2P.CONN.COF.GRIND.MOTOR FUSE 2A SMRO UL <i>2P.CONN.COF.GRIND.MOTOR FUSE 2A SMRO UL</i>
	21		17800687	ПРОВОД С РАЗЪЕМАМИ ДЛЯ ДАТЧИКА ХОЛА ГОРИЗОНТАЛЬНОЙ КОФЕ... <i>3POLES CONNECTOR MC SENSOR SMR UL</i>
	22		17001921	BLK WIRING FIX INSERT FOR GRINDER BOARD <i>BLK WIRING FIX INSERT FOR GRINDER BOARD</i>
	23		11000194	BLACK COFFEEGRINDER MOTOR SUPPORT P124 <i>BLACK COFFEEGRINDER MOTOR SUPPORT P124</i>
	24		11000511	MOTOR COFFEEGRINDER V3.1 120VASSY. <i>AS.MOTORE MC V3.1 MOD=1.25 SX 120V</i>
	24		11000512	MOTOR COFFEEGRINDER V3.1 100VASSY. <i>MOTOR COFFEEGRINDER V3.1 100VASSY.</i>

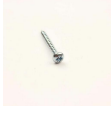
Model Machine











MACSAE205 KABOBAPKA OCS SAE LIRIKA PLUS SIL 230/50 SCH (10004477)1000052

	24		11000513	MOTOR COFFEEGRINDER V3.1 230VASSY. <i>MOTOR COFFEEGRINDER/V3.1 230V ASSY NUOVO PREZZO 14,3</i>
	25		149199050	BLK SENSOR SUPPORT FOR COF.GRINDER MOTOR <i>SUPP.SENS.TERMICO MOTORE MC NER.</i>
	26		128381800	STEEL CRINKLE WASHER 21,8X14X0,25 <i>STEEL CRINKLE WASHER 21,8X14X0,25</i>
	27		181540900	ELECTR.BOARD WITH SENSOR HAL506 SF-K <i>ELECTRONIC BOARD WITH SENSOR HAL506</i>
	28		123030200	RADIAL BEARING 61900.2RS1 <i>RADIAL BEARING 61900.2RS1</i>
	29		226000300	GEAR SX Z=38 FOR GRINDER MOTION ASSY. <i>GEAR SX Z=38 FOR GRINDER MOTION ASSY.</i>
	30		145854360	BLK GROUND COFFEE CONT.UPPER SEAL SMART1 <i>BLK GROUND COFFEE CONT.UPPER SEAL SMART1</i>
	31		11026355	BLK GROUND COFF.OUTLET CONVEYOR V4 ASSY. <i>AS.CONVOGL. USCITA CAF.MAC.V4 SMART1 NER.</i>
	32		421944060561	GRY GROUND COF.CONT.LOWER SEALV2 SMART1 <i>GUARN.INF.CONT.CAF.MAC.V2 SMART1 GRI.</i>
	33		149214800	MC V3 MOD=1,25 WORM SCREW CENTRING CAP <i>MC V3 MOD=1,25 WORM SCREW CENTRING CAP</i>
	34		129661702	SCREW TCB TORX 3,5X30 PLAST.ZN-B <i>SCREW TCB TORX 3,5X30 PLAST.ZN-B</i>
	35		11002873	INSULATOR BUSH FOR GRINDER MOTOR P124 <i>INSULATOR BUSH FOR GRINDER MOTOR P124</i>
	36		128381902	STEEL FLAT WASHER DI=4,3 DE=14SP=1,5 <i>STEEL FLAT WASHER DI=4,3 DE=14 SP=1,5</i>

Model Machine

MACSAE205

КАВОВАРКА OCS SAE LIRIKA PLUS SIL 230/50 SCH (10004477)10000052

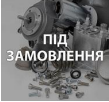
	37		128310402	GALV.WASHER UNI 8842 A4 GALV.WASHER UNI 8842 A4
	38		129574802	SCREW TCB TORX 20 M4X30 ZN-B SCREW TCB TORX 20 M4X30 ZN-B
	39		11000597	STEEL COF.GRINDER SUPPORT SPRING P124 COFFEE GRINDER SUPPORT SPRING P124
	40		421944054591	GEN.MOTOR COF.GRINDER V2 SMRO120V ASSY GEN.MOTOR COF.GRINDER V2 SMRO120V ASSY
	40		421944054611	GEN.MOTOR COF.GRINDER V2 SMRO230V ASSY GEN.MOTOR COF.GRINDER V2 SMRO 230V ASSY
	40		421944054641	GEN.MOTOR COF.GRINDER V2 SMRO100V ASSY GEN.MOTOR COF.GRINDER V2 SMRO100V ASSY

Model Machine

MACSAE205

KABOBAPKA OCS SAE LIRIKA PLUS SIL 230/50 SCH (1000477)1000052

MACSAE205.T.0005



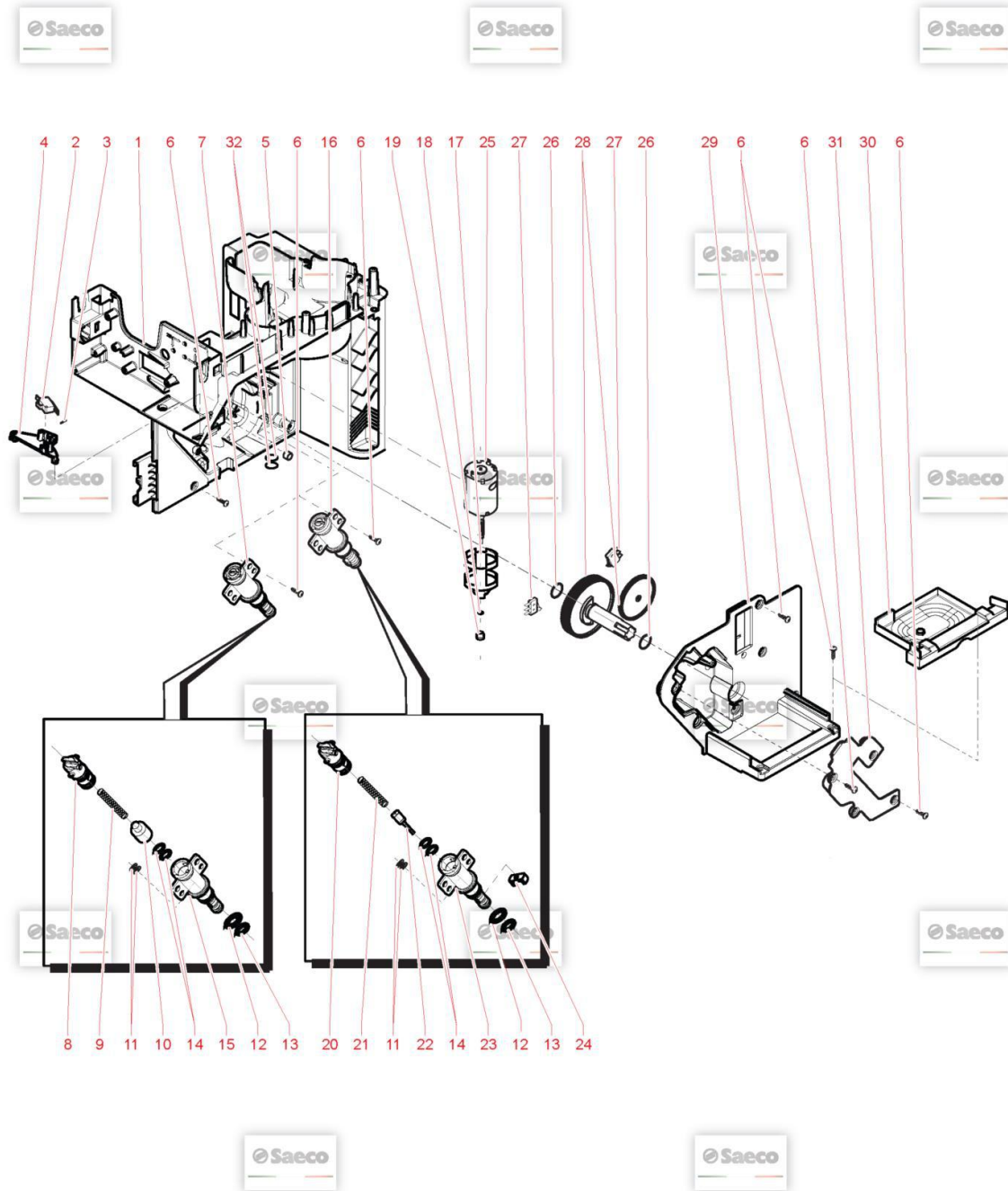













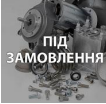

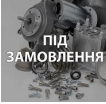





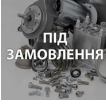

TAVOLA NR. 5 - ARTICOLO KABOBAPKA OCS SAE LIRIKA PLUS SIL 230/50 SCH (1000477)
1000052

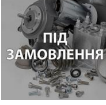

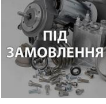
Model Machine

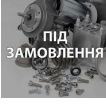
MACSAE205













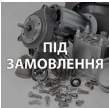













КАВОВАРКА OCS SAE LIRIKA PLUS SIL 230/50 SCH (10004477)10000052

Web	Pos.	Foto	Item - Replace by	Description
				<i>Press - CTRL + CLICK go to item in a new window Натисніть - Ctrl + права кнопка миші щоб відкрити запчастину в новому вікні</i>
	1		421944043602	BLK RATIOMOTOR MOUNTING PLATEV2 SMRG AS <i>BLK RATIOMOTOR MOUNTING PLATE V2 SMRG AS</i>
	2		12001890	MICROSWITCH XG/V3D <i>MICROSWITCH XG/V3D</i>
	3		421944006861	STEEL SPRING FOR MICRO COMPENSATOR SMR <i>STEEL SPRING FOR MICRO COMPENSATOR SMR</i>
	4		17001508	BLACK MICRO COMPENSATOR SMR <i>BLACK MICRO COMPENSATOR SMR</i>
	5		9161.111	MAGNET FOR FLOAT SUPERAUT. <i>MAGNET FOR FLOAT SUPERAUT.</i>
	6		12001728	SCREW TCBR TORX 10 3,5X12 PLAST.SS <i>SCREW TCBR TORX 10 3,5X12 PLAST.SS</i>
	7		421946011491	BLK PIN FOR BOILER VALVE 4BARASSY. <i>AS.PERNO CALD.VALV.4BAR NER.</i>
	8		421944027691	BLK CAP FOR PIN BOILER VALVE 4BAR <i>BLK CAP FOR PIN BOILER VALVE 4BAR</i>
	9		421944036701	SPRING FOR PIN BOILER VALVE 4BAR <i>SPRING FOR PIN BOILER VALVE 4BAR</i>
	10		421944038251	MUSHROOM VALVE FOR FLOW SELECT.V2 P0057 <i>MUSHROOM VALVE FOR FLOW SELECT.V2 P0057</i>
	11		140328059	OR 2015 SILICONE PTFE/FDA <i>OR 2015 SILICONE PTFE/FDA</i>
	12		NM01.035	OR ORM 0090-20 SILICONE <i>OR ORM 0090-20 SILICONE</i>
	13		NM01.057	OR ORM 0050-20 IN SILICONE <i>OR ORM 0050-20 IN SILICONE</i>

Model Machine

MACSAE205

KABOBAPKA OCS SAE LIRIKA PLUS SIL 230/50 SCH (10004477)10000052

	14		140324459	OR ORM 0060-20 SILICONE PTFE/FDA OR ORM 0060-20 IN SILICONE PTFE/FDA
	15	 ПІД ЗАМОВЛЕННЯ	421944027711	BLK PIN FOR BOILER VALVE 4BAR BLK PIN FOR BOILER VALVE 4BAR
	16		11005060	PIN V2 FOR BOILER ASSY. PIN V2 FOR BOILER P119 ASSY. NUOVO PREZZO 8,37
	17		9121.044	ANTIVIBRATION FOR MOTOR ANTIVIBRANTE X MOTORE
	18		148380200	BAKELIZZATE WASHER D=5,5 BAKELIZZATE WASHER D=5,5
	19		9121.046	BRONZE SINTERED BUSH FOR MOTOR RATIO MOT. BRONZE SINTERED BUSH FOR MOTOR RATIO MOT.
	20		11003820	BLACK CAP V2 FOR PIN BOILER P119 BLACK CAP V2 FOR PIN BOILER P119
	21		9011.132	SS SPRING FOR PIN MOLLA X SPILLO
	22	 ПІД ЗАМОВЛЕННЯ	421944028601	L-F/BR.PISTON L=20,9 ASSY. L-F/BR.PISTON L=20,9 ASSY.
	23		11003801	NAT.PIN V2 FOR BOILER P119 NATURAL PIN V2 FOR BOILER P119
	24		11005099	NATURAL CURSOR V2 FOR BOILER P119 NATURAL CURSOR V2 FOR BOILER P119
	25		11005214	MOTOR FOR RATIO MOTOR ASSY. MOTOR FOR RATIO MOTOR P124 ASSY
	26		9161.132	MYLAR WASHER FOR RATIO MOTOR MYLAR WASHER FOR RATIO MOTOR
	27		421946025541	MICROSWITCH XC/SM1 V2 MICROSWITCH XC/SM1 V2

Model Machine

MACSAE205

КАВОВАРКА OCS SAE LIRIKA PLUS SIL 230/50 SCH (10004477)10000052

	28		20000900	SPARES KIT GEARS FOR RATIOMOTOR V2 <i>SPARES KIT GEARS FOR RATIOMOTOR V2</i>
	29	 ПІД ЗАМОВЛЕННЯ	421941287512	BLK RATIOMOT.MOUNTING PLATE COVER V2 SMR <i>BLK RATIOMOT.MOUNTING PLATE COVER V2 SMR</i>
	30		421944062701	BLK BREW UNIT DRAWER COFFEE V2SMR <i>BLK BREW UNIT DRAWER COFFEE V2 SMR</i>
	31	 ПІД ЗАМОВЛЕННЯ	17000730	BLACK BOILER SEAT PIN COVER SMR <i>BLACK BOILER SEAT PIN COVER SMR</i>
	32	 ПІД ЗАМОВЛЕННЯ	DM0041/081	O-RING 112 IN EPDM 70 SH <i>O-RING 112 IN EPDM 70 SH</i>

Model Machine

MACSAE205

KABOBAPKA OCS SAE LIRIKA PLUS SIL 230/50 SCH (1000477)1000052

MACSAE205.T.0006



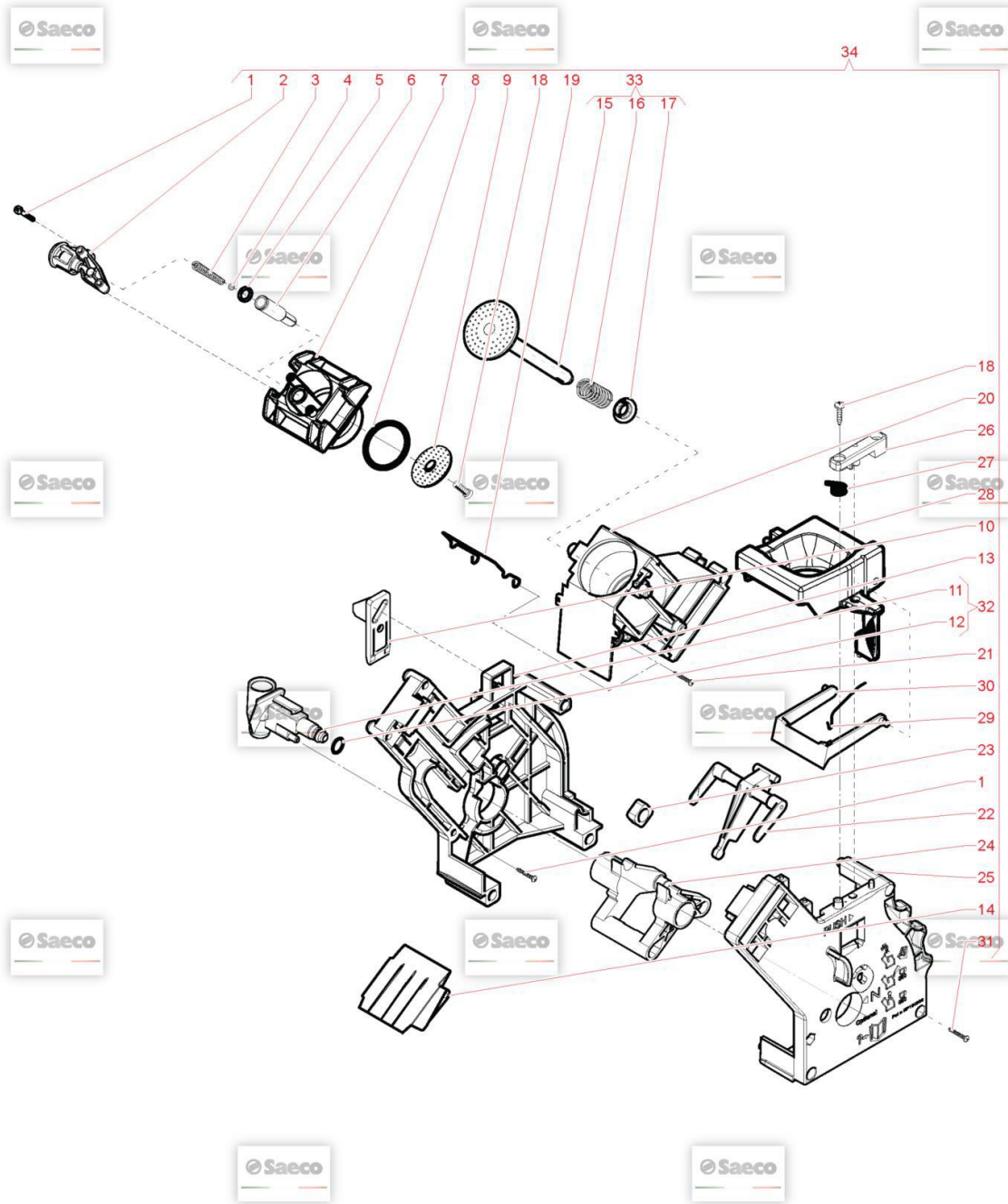























TAVOLA NR. 6 - ARTICOLO KABOBAPKA OCS SAE LIRIKA PLUS SIL 230/50 SCH (1000477)
1000052



Model Machine

MACSAE205











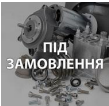















КАВОВАРКА OCS SAE LIRIKA PLUS SIL 230/50 SCH (10004477)10000052

Web	Pos.	Foto	Item - Replace by	Description
				<i>Press - CTRL + CLICK go to item in a new window Натисніть - Ctrl + права кнопка миші щоб відкрити запчастину в новому вікні</i>
	1		12000550	CAMOPI3 TCB TORX 10 3X25 PLAST.SS SCREW TCB TORX 10 3X25 PLAST.SS
	2		421944065221	BLK BREW UNIT COF.OUTLET SLEEVE SMR ASSY BLK BREW UNIT COF.OUTLET SLEEVE SMR ASSY
	3		11012095	ПРУЖИНА КОНТРПОРШНЯ РОБОЧОГО БЛОКУ SAECO 421944082361 SS COFFEE UNIT CONTERPISTON SPRING S0053
	3		9161.222	SS.CONICAL SPRING MOLLA CONICA
	4	 ПІД ЗАМОВЛЕННЯ	421944034451	BOROSILICATE SPHERE D.5 MM BOROSILICATE SPHERE D.5
	5	 LIBERTY UKRAINE	140328761	OR ORM 0060-15 TERMOIL OR ORM 0060-15 TERMOIL
	6	 ПІД ЗАМОВЛЕННЯ	11009276	BLK COUNTER PISTON TUBE BREW UNIT S0053 BLK COUNTER PISTON TUBE BREW UNIT S0053
	7		11001840	BLACK COUNTER PISTON BREW UNIT8GR.P124 CONTROPIST.GRUP.8GR.P124 NER.
	8		NM01.044	OR ORM 0320-40 SILICONE PTFE/FDA OR ORM 0320-40 SILICONE PTFE
	9		9161.268	PERCOLATOR DE=35,8 ELFO PERCOLATOR DE=35,8 ELFO
	10	 ПІД ЗАМОВЛЕННЯ	421944046931	YLW BREW UNIT COUPLING PLATE V2 SMART YLW BREW UNIT COUPLING PLATE V2 SMART
	11		9161.064.050	BLACK WATER INLET SLEEVE BREWUNIT ROYAL BLACK WATER INLET SLEEVE BREW UNIT ROYAL
	12		NM02.007	OR 2025 IN TERMOIL OR 2025 TERMOIL

Model Machine

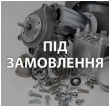
MACSAE205

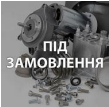











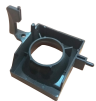

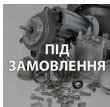

КАВОВАРКА OCS SAE LIRIKA PLUS SIL 230/50 SCH (10004477)10000052

	13		9161.375.050	BLACK BREW UNIT REAR PLATE SMART <i>BLACK BREW UNIT REAR PLATE SMART</i>
	14		17000737	ЧОРНА НАКЛАДКА РОБ. ГР. ДЛЯ ВИДАЛЕННЯ ЖМИХУ L=56,3 <i>BLACK BREW UNIT CONVEYOR SLIDE L=56,3</i>
	15		421944065791	GRY BREW UNIT INTEGR.PISTON 8GR.V3 ASSY <i>GRY BREW UNIT INTEGR.PISTON 8GR.V3 ASSY</i>
	16		9161.198	SS.8GR.BREW UNIT PISTON SPRING <i>SS.8GR.BREW UNIT PISTON SPRING</i>
	17		9161.191	WHITE 8GR.-12GR.BREW UNIT PISTON BUSH <i>BOCCOLA X PISTONE NEUTRO</i>
	18		12000895	SCREW TSP TORX 10 3X10 PLAST.SS <i>SCREW TSP TORX 10 3X10 PLAST.SS</i>
	19		11001556	SS BREW UNIT SPRING H=49 SMART <i>SS BREW UNIT SPRING H=49 SMART</i>
	20		421944014611	BLK COF.CONTAIN.BREW UNIT V2 M5000 ASSY. <i>BLK COF.CONTAIN.BREW UNIT V2 M5000 ASSY.</i>
	21		129912521	SCREW TCBR TORX 10 3,5X14 PLAST.SS <i>SCREW TCBR TORX 10 3,5X14 PLAST.SS</i>
	22		11003078	BLACK CONNECTING ROD BREW UNIT8GR. <i>BLACK CONNECTING ROD BREW UNIT 8GR.</i>
	23		9161.094.050	BLACK BREW UNIT DRILLED BLOCK <i>BLACK BREW UNIT DRILLED BLOCK</i>
	24		421944051231	YLW BREW UNIT ELBOW SHAFT M5000 <i>YLW BREW UNIT ELBOW SHAFT M5000</i>
	25		11005920	BLACK BREW UNIT FRONT PLATE S/SCR.SMART <i>PIAS.ANT.GRUP.S/F.SMART NER.SER.NEW</i>
	26		421944050711	YLW BREWUNIT HOPPER BLOCKING PLATE SMART <i>YLW BREWUNIT HOPPER BLOCKING PLATE SMART</i>

Model Machine

MACSAE205

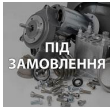
КАВОВАРКА OCS SAE LIRIKA PLUS SIL 230/50 SCH (10004477)10000052

	27		9161.378	SS HOPPER SPRING FOR BREW UNITSMART <i>SS HOPPER SPRING FOR BREW UNIT SMART</i>
	28		149261350	BLACK HOPPER DOSER BREW UNIT SMART1 <i>BLACK HOPPER DOSER BREW UNIT SMART1</i>
	29		9161.046	ПРУЖИНА ВОРОНКИ ЗАВАРОЧНОГО БЛОКА ДЛЯ КОФЕМАШИН PHILIPS ... <i>MOLLA X RASATORE GRUPPO</i>
	30		11004161	BLACK SCRAPER FOR BREW UNIT M5000 <i>BLACK SCRAPER FOR BREW UNIT M5000</i>
	31		12000897	SCREW TCB TORX 10 3,5X20 PLAST.SS <i>SCREW TCB TORX 10 3,5X20 PLAST.SS</i>
	32		20000440	BLACK WATER INLET SLEEVE BREWUNIT ASSY. <i>BLACK WATER INLET SLEEVE BREW UNIT ASSY.</i>
	33		421944065811	НИЖНІЙ ПОРШЕНЬ РОБОЧОГО БЛОКУ 8GR. V3 ВЗБОРІ <i>AS.GEN.PIST.INTEGR.GRUP.CAF.8GR.V3 GRI.</i>
	34		421944052401	BLK/YLW BREW UNIT 8GR.5BAR SMR <i>BLK/YLW BREW UNIT 8GR.5BAR SMR</i>
	34		421944052461	BLK/YLW BREW UNIT 8GR.8BAR V3SMR <i>BLK/YLW BREW UNIT 8GR.8BAR V3 SMR</i>