

# Model Machine

MACSAE168

KABOBAPKA OCS SAE LIRIKA OTC SIL 230/50 SCH(10004768 )

MACSAE168.T.0001



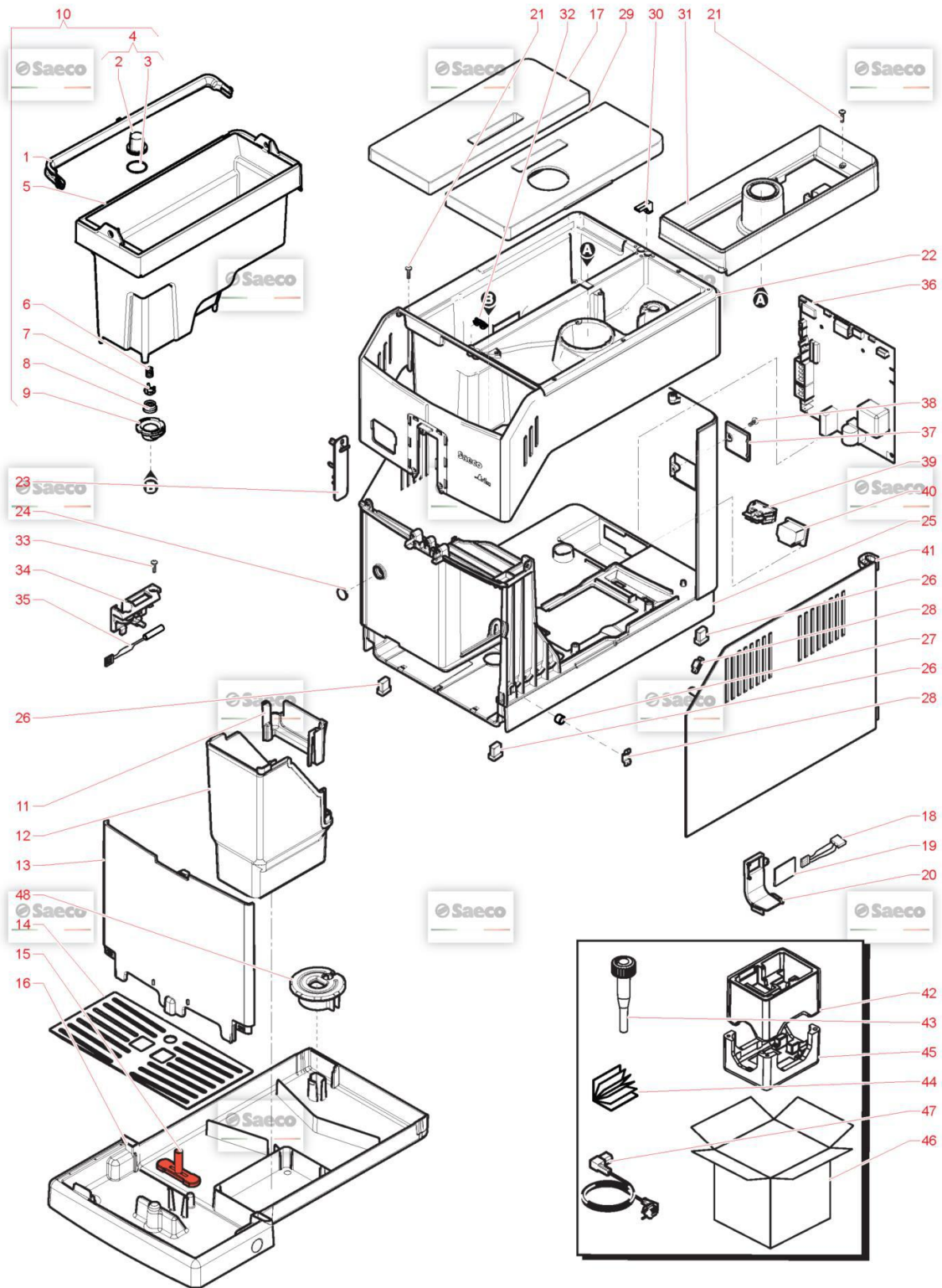











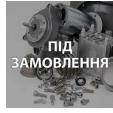





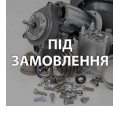



TAVOLA NR. 1 - ARTICOLO KABOBAPKA OCS SAE LIRIKA OTC SIL 230/50 SCH( 10004768 )



## Model Machine

MACSAE168

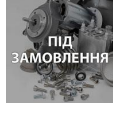









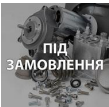



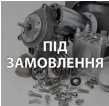











КАВОВАРКА OCS SAE LIRIKA OTC SIL 230/50 SCH(10004768 )

Web	Pos.	Foto	Item - Replace by	Description
				<i>Press - CTRL + CLICK go to item in a new window Натисніть - Ctrl + права кнопка миші щоб відкрити запчастину в новому вікні</i>
	1		11023155	BLACK WATER CONTAINER HANDLE MDS BLACK WATER CONTAINER HANDLE MDS
	2	 ПІД ЗАМОВЛЕННЯ	144650800	WHITE WATER CONTAINER EXT.FILTER WHITE WATER CONTAINER EXT.FILTER
	3		140328461	ПРОКЛАДКА O-RING 0190-10 ДЛЯ КОФЕМАШИНЫ PHILIPS SAECO 99653... OR METRICO 0190-10 IN EPDM NUOVO PREZZO 0,13
	4		224640200	БІЛИЙ ПЛАСТИКОВИЙ ФІЛЬТР У КОНТЕЙНЕР ВОДИ SAECO 996530029115 EXTERNAL FILTER FOR WATER CONTAINER ASSY
	5	 ПІД ЗАМОВЛЕННЯ	421944059661	TRANSP/GRY WATER CONTAINER V2SMRO TRANSP/GRY WATER CONTAINER V2SMRO
	6		11003672	SS SPRING FOR WATER CONTAIN.VALVE P0049 SPRING FOR WATER CONTAINER VALVE P0049
	7		421941157852	GRY WATER CONTAINER VALVE INSERT P0049 GRY WATER CONTAINER VALVE INSERT P0049
	8		11003671	РЕЗИНКА КЛАПАНУ БАКА ВОДИ P0049 SAECO GAGGIA PHILIPS 9965300... TRANSP.VALVE FOR WATER CONTAINER P0049
	9		17001366	BLACK LID FOR DUCKBILL VALVE SMR BLACK LID FOR DUCKBILL VALVE SMR
	10		421944060271	КОНТЕЙНЕР ВОДИ SAECO LIRIKA 421944059661 TRANSP/GRY WATER CONTAINER V2 SMRO ASSY
	11	 ПІД ЗАМОВЛЕННЯ	421944063131	BLK DUMP BOX INSERT V2 NPR BLK DUMP BOX INSERT V2 NPR
	12		421944060591	BLK DUMP BOX V2 SMR CAS.FONDI V2 SMR NER.

## Model Machine

MACSAE168

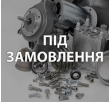

















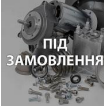

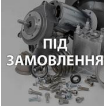

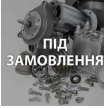

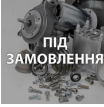

КАВОВАРКА OCS SAE LIRIKA OTC SIL 230/50 SCH(10004768 )

	13	 ПІД ЗАМОВЛЕННЯ	421944052971	G/ANM DRIP TRAY INSERT V2 SMRO/PT <i>G/ANM DRIP TRAY INSERT V2 SMRO/PT</i>
	14		421944031791	BA/SS GRATE FOR DRIP TRAY SMR/B-H-P <i>GRIGLIA VASCA REC.ACQ.SMR/B-H-P INOX/BA</i>
	14	 ПІД ЗАМОВЛЕННЯ	421944034471	BA/SS GRATE FOR DRIP TRAY SMR/T <i>BA/SS GRATE FOR DRIP TRAY SMR/T</i>
	15		421941304791	RED/3003 FLOAT FOR DRIP TRAY XSM <i>RED/3003 FLOAT FOR DRIP TRAY XSM</i>
	16		421944063571	G/ANM DRIP TRAY SMRO/PT <i>G/ANM DRIP TRAY SMRO/PT</i>
	17		421944042421	КРИШКА БУНКЕРУ ВОДИ СІРА (АНТРАЦИТ) <i>G/ANM WATER CONTAINER LID SMRG/TE</i>
	18	 ПІД ЗАМОВЛЕННЯ	421946035161	3P.CONN.WATER LEVEL V2 SMR ULASSY <i>AS.CONN.3P.LIVELLO ACQ.V2 SMR UL</i>
	19		11003232	AS.CPU+SW WATER LEVEL SENSOR V2 <i>AS.CPU+SW WATER LEVEL SENSOR V2</i>
	20		17001474	BLACK WATER LEVEL SENSOR SUPPORT SMR <i>BLACK WATER LEVEL SENSOR SUPPORT SMR</i>
	21		12001728	SCREW TCBR TORX 10 3,5X12 PLAST.SS <i>SCREW TCBR TORX 10 3,5X12 PLAST.SS</i>
	22	 ПІД ЗАМОВЛЕННЯ	421944052961	G/ANM UP.CASING COVER V3 S/SCR.SMRO/PT <i>COP.SUP.CARC.V3 SMRO/PT ANM/L SER.</i>
	22	 ПІД ЗАМОВЛЕННЯ	421946037431	G/ANT UPP.CAS.COVER HOL.S/SCR.SMRO 120V <i>G/ANT UPP.CAS.COVER HOL.S/SCR.SMRO 120V</i>
	23	 ПІД ЗАМОВЛЕННЯ	421944051401	BLK MILK INTAKE TUBE SUPPORT SMRO/PC <i>BLK MILK INTAKE TUBE SUPPORT SMRO/PC</i>
	24	 ПІД ЗАМОВЛЕННЯ	11031523	BLACK INFRAREDS PLATE RYL <i>BLACK INFRAREDS PLATE RYL</i>

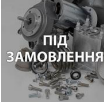
## Model Machine

MACSAE168















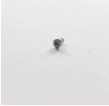

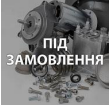





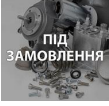

KABOBAPKA OCS SAE LIRIKA OTC SIL 230/50 SCH(10004768 )

	25		<b>421944063611</b>	M/BLK CASING V3 SMR ASSY AS.CARC.V3 SMR NER/OP.
	26		<b>17001556</b>	TRANSP.SILICONE FOOT SMR TRANSP.SILICONE FOOT SMR
	27		<b>9161.111</b>	MAGNET FOR FLOAT SUPERAUT. MAGNET FOR FLOAT SUPERAUT.
	28		<b>11013220</b>	STEEL PLATE FOR DOOR MAGNET XSM STEEL PLATE FOR DOOR MAGNET XSM
	29	 ПІД ЗАМОВЛЕННЯ	<b>421944042951</b>	G/ANM BEAN COF.CONT.LID SMRG/TE G/ANM BEAN COF.CONT.LID SMRG/TE
	29	 ПІД ЗАМОВЛЕННЯ	<b>421944061901</b>	ANM/L BEAN COF.CONT.LID SMRO ASSY. ANM/L BEAN COF.CONT.LID SMRO ASSY.
	30	 ПІД ЗАМОВЛЕННЯ	<b>421944032481</b>	BACK PLUG UPPER COVER CASING SMRO BACK PLUG UPPER COVER CASING SMRO
	31		<b>421944059671</b>	TRANSP/GRY BEAN COF.CONTAINERV3 SMRO TRANSP/GRY BEAN COF.CONTAINER V3 SMRO
	32	 ПІД ЗАМОВЛЕННЯ	<b>421944032361</b>	FRONT PLUG UPPER COVER CASINGSMRO FRONT PLUG UPPER COVER CASING SMRO
	33		<b>12000895</b>	SCREW TSP TORX 10 3X10 PLAST.SS SCREW TSP TORX 10 3X10 PLAST.SS
	34	 ПІД ЗАМОВЛЕННЯ	<b>421944009421</b>	BLK REED SUPPORT SMRO BLK REED SUPPORT SMRO
	35		<b>17800442</b>	2POLES CONNECT.SENSOR REED DUMP BOX CST 2POLES CONNECT.SENSOR REED DUMP BOX CST
	36		<b>421941308901</b>	CPU+SW SMRO/T 230V ASSY. AS. CPU+SW SMRO/T 230V
	36	 ПІД ЗАМОВЛЕННЯ	<b>421941310581</b>	CPU PWR + SW LIRIKA OTC 120V ASSY AS.CPU PWR + SW LIRIKA OTC 120V

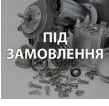
## Model Machine

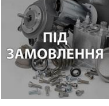
MACSAE168











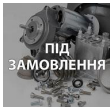

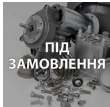

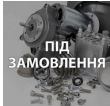

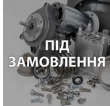

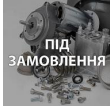

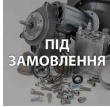

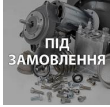

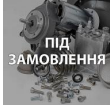

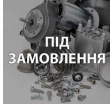
КАВОВАРКА OCS SAE LIRIKA OTC SIL 230/50 SCH(10004768 )

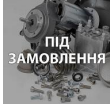
	36		<b>421944080441</b>	AS. CPU+SW SMRO/T V2 230V AS. CPU+SW SMRO/T V2 230V
	37		<b>17001484</b>	MATT/BLK REAR CASING PROGRAM.INSERT NPR MATT/BLK REAR CASING PROGRAM.INSERT NPR
	38		<b>129913202</b>	SCREW TCB TORX 10 3X8 PLAST.ZN-B SCREW TCB TORX 10 3X8 PLAST.ZN-B
	39		<b>242212625104</b>	SWI POW 2P 12A 250V FASTON GP12H B SWI POW 2P 12A 250V FASTON GP12H B
	39		<b>242212625106</b>	SWI POW 2P 10A 250V FASTON 8500 B SWI POW 2P 10A 250V FASTON 8500 B
	40		<b>12000280</b>	CUP SOCKET EN 60320 C 13 CUP SOCKET EN 60320 C 13
	41		<b>17001065</b>	MATT/BLACK RIGHT SIDE DOOR SMR MATT/BLACK RIGHT SIDE DOOR SMR
	42		<b>421944055261</b>	PS-E UPPER INSERT FOR BOX SMRG/TE PS-E UPPER INSERT FOR BOX SMRG/TE
	43		<b>11003785</b>	BLACK GRINDER ADJUSTMENT KEY P0049 CHIAVE REG.MACIN.CAF.P0049 NER 0049 BLACK GRINDER ADJUSTMEN...
	44		<b>421944067542</b>	MANUAL V2 SAE RI9851 SMRO/PT KOR MANUAL V2 SAE RI9851 SMRO/PT KOR
	44		<b>421944074111</b>	MANUAL V2 SAE RI9851 SMRO/PT CHN MANUAL V2 SAE RI9851 SMRO/PT CHN
	44		<b>421944076421</b>	MANUAL SAE SUP041EU SMRO/P TWN MANUAL SAE SUP041EU SMRO/P TWN
	44		<b>421946032122</b>	MANUAL SAE RI9851 V2 SMRO/PT IT MANUAL SAE RI9851 V2 SMRO/PT IT

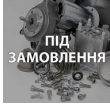
## Model Machine

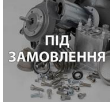
MACSAE168

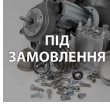















KABOBAPKA OCS SAE LIRIKA OTC SIL 230/50 SCH(10004768 )

	44		<b>421946032132</b>	MANUAL V2 SAE RI9851 SMRO/PT GB <i>MANUAL V2 SAE RI9851 SMRO/PT GB</i>
	44		<b>421946032142</b>	MANUAL SAE RI9851 V2 SMRO/PT DE <i>MANUAL SAE RI9851 V2 SMRO/PT DE</i>
	44		<b>421946032152</b>	MANUAL SAE RI9851 V2 SMRO/PT FR <i>MANUAL SAE RI9851 V2 SMRO/PT FR</i>
	44		<b>421946032162</b>	MANUAL SAE RI9851 V2 SMRO/PT ES <i>MANUAL SAE RI9851 V2 SMRO/PT ES</i>
	44		<b>421946032172</b>	MANUAL SAE RI9851 V2 SMRO/PT PT <i>MANUAL SAE RI9851 V2 SMRO/PT PT</i>
	44		<b>421946032182</b>	MANUAL SAE RI9851 V2 SMRO/PT NL <i>MANUAL SAE RI9851 V2 SMRO/PT NL</i>
	44		<b>421946032192</b>	MANUAL SAE RI9851 V2 SMRO/PT SV <i>MANUAL SAE RI9851 V2 SMRO/PT SV</i>
	44		<b>421946032212</b>	MANUAL SAE RI9851 V2 SMRO/PT PL <i>MANUAL SAE RI9851 V2 SMRO/PT PL</i>
	44		<b>421946032222</b>	MANUAL SAE RI9851 V2 SMRO/PT RU <i>MANUAL SAE RI9851 V2 SMRO/PT RU</i>
	44		<b>421946032232</b>	MANUAL SAE RI9851 V2 SMRO/PT HU <i>MANUAL SAE RI9851 V2 SMRO/PT HU</i>
	44		<b>421946032242</b>	MANUAL SAE RI9851 V2 SMRO/PT CS <i>MANUAL SAE RI9851 V2 SMRO/PT CS</i>
	44		<b>421946032252</b>	MANUAL SAE RI9851 V2 SMRO/PT SK <i>MANUAL SAE RI9851 V2 SMRO/PT SK</i>
	44		<b>421946032262</b>	MANUAL SAE RI9851 V2 SMRO/PT RO <i>MANUAL SAE RI9851 V2 SMRO/PT RO</i>
	44		<b>421946032272</b>	MANUAL SAE RI9851 V2 SMRO/PT BG <i>MANUAL SAE RI9851 V2 SMRO/PT BG</i>

## Model Machine

MACSAE168

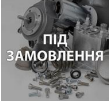
КАВОВАРКА OCS SAE LIRIKA OTC SIL 230/50 SCH(10004768 )

	45		<b>13001671</b>	PS-E LOWER INSERT FOR BOX SMR <i>INS.INF.SCAT.SMR PS-E</i>
	46		<b>421940312311</b>	WHT EXTERNAL BOX SMRO SAE LIRIKA <i>WHT EXTERNAL BOX SMRO SAE LIRIKA</i>
	47		<b>11001985</b>	BLACK POWER CABLE KOREA L=1200 <i>BLACK POWER CABLE KOREA L=1200</i>
	47		<b>11004247</b>	BLACK POWER CABLE RVV 3X1 CHINA L=1200 <i>BLACK POWER CABLE RVV 3X1 CHINA L=1200</i>
	47		<b>183911050</b>	ЧОРНИЙ КАБЕЛЬ SCHUKO L=1200 SAECO <i>BLACK POWER CABLE SCHUKO L=1200</i>
	47		<b>183921950</b>	POWER CABLE SJT3 USA BLACK ULL=1200 <i>POWER CABLE SJT3 USA BLACK UL L=1200</i>
	47		<b>421946041821</b>	BLK POWER CABLE TAIWAN V2 HVCTF L=1200 <i>BLK POWER CABLE TAIWAN V2 HVCTF L=1200</i>
	47		<b>NE01.093</b>	CABLE ARGENTINA + PLUG EN60320C13 <i>CABLE ARGENTINA + PLUG EN60320 C13</i>
	48		<b>17000674</b>	BLACK WATER DRAINAGE CONVEYORSMR/B-T <i>BLACK WATER DRAINAGE CONVEYOR SMR/B-T</i>

# Model Machine

MACSAE168

KABOBAPKA OCS SAE LIRIKA OTC SIL 230/50 SCH(10004768 )

MACSAE168.T.0002

TAVOLA NR. 2 - ARTICOLO KABOBAPKA OCS SAE LIRIKA OTC SIL 230/50 SCH( 10004768 )

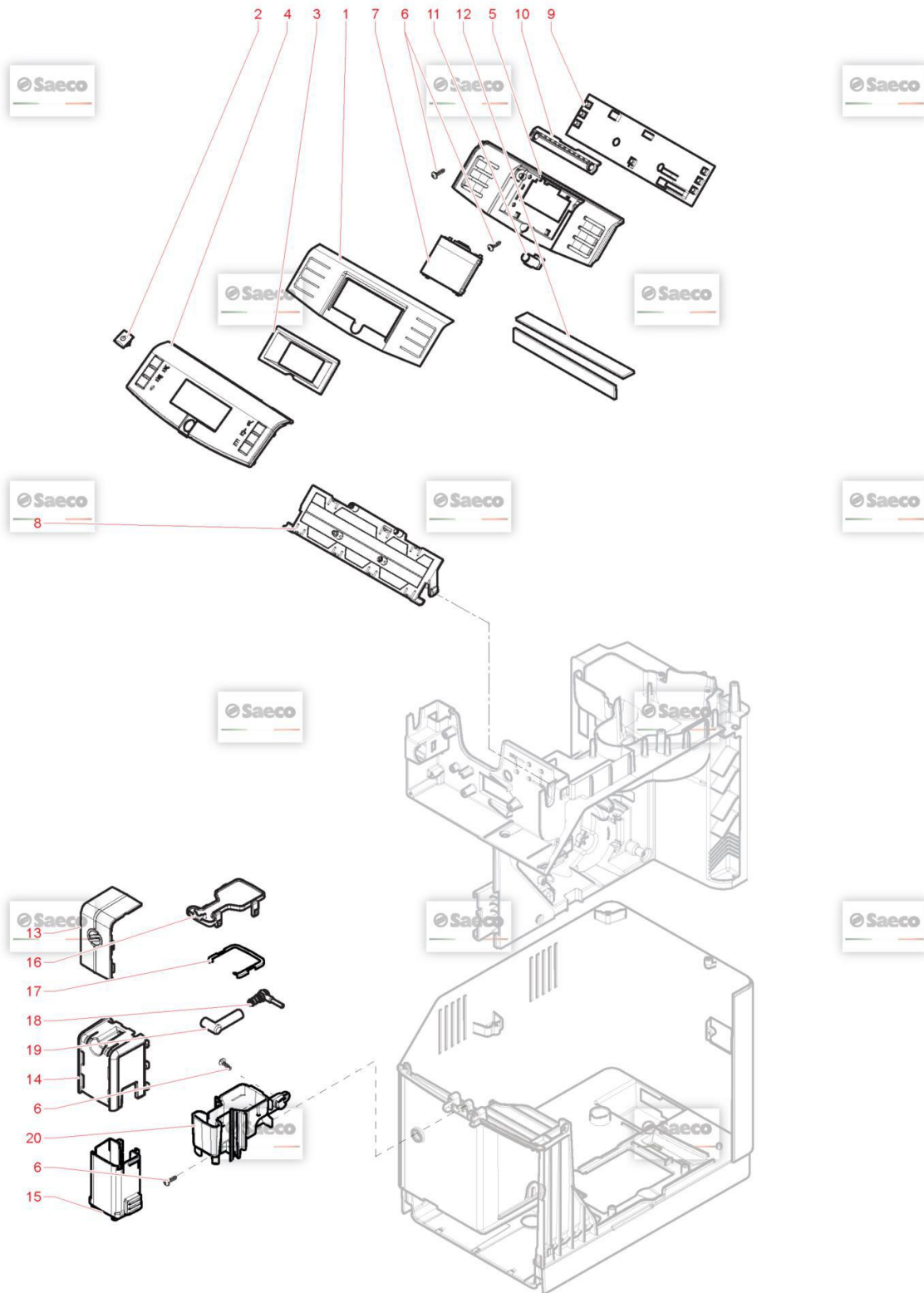















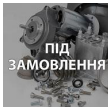









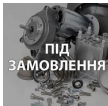

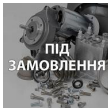

## Model Machine

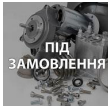
MACSAE168











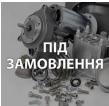









КАВОВАРКА OCS SAE LIRIKA OTC SIL 230/50 SCH(10004768 )

Web	Pos.	Foto	Item - Replace by	Description
				<i>Press - CTRL + CLICK go to item in a new window Натисніть - Ctrl + права кнопка миші щоб відкрити запчастину в новому вікні</i>
	1		421944025241	BLK FRONT PANEL MEMBRANE V3 SMR/H-P-T <i>BLK FRONT PANEL MEMBRANE V3 SMR/H-P-T</i>
	2		421944009351	TRANSP.STAND-BY BUTTON S/SCR.SMRO <i>TASTO STAND-BY SMRO TRASP.SER.</i>
	3		17001270	BLACK DISPLAY FRAME SMR <i>BLACK DISPLAY FRAME SMR</i>
	4		421944057791	SS DISPLAY FRONT PAN.S/SCR.SMRO/PT ASSY <i>AS.FRONT.DISPLAY SMRO/PT INOXSER.</i>
	5		421944017321	BLK DISPLAY SUPPORT V2 SMR/H-P-T ASSY. <i>BLK DISPLAY SUPPORT V2 SMR/H-P-T ASSY.</i>
	6		12000450	SCREW TCBR TORX 10 3,5X12 PLAST.ZN-N <i>SCREW TCBR TORX 10 3,5X12 PLAST.ZN-N</i>
	7		421941307861	DISPLAY HIGO FL <i>DISPLAY HIGO FL INTELIA MINUTO INTELIA DELUX INTELIA EVO</i>
	8		17000704	BLACK DISPLAY KEYBOARD SUPPORTSMR <i>BLACK DISPLAY KEYBOARD SUPPORT SMR</i>
	9		421941303001	KYB - DISPLAY SMR/H 230V <i>KYB - DISPLAY SMR/H 230V</i>
	9		421941303571	KYB - DISPLAY SMR/H 120V <i>KYB - DISPLAY SMR/H 120V</i>
	10		17001253	BLK FRONT.PANEL MEMBRANE SUPP.SMR/H-P-T <i>BLK FRONT.PANEL MEMBRANE SUPP.SMR/H-P-T</i>
	11		17002075	WHITE STAND-BY BUTTON LIGHT GUIDE SMR <i>WHITE STAND-BY BUTTON LIGHT GUIDE SMR</i>
	12		421944008251	BLK ADH.AERSTOP SMR <i>BLK ADH.AERSTOP SMR</i>

## Model Machine

MACSAE168

КАВОВАРКА OCS SAE LIRIKA OTC SIL 230/50 SCH(10004768 )

	13		421944031761	BA SS COF.DISPENS.FRONT PLATECOVER SMR <i>BA SS COF.DISPENS.FRONT PLATECOVER SMR</i>
	14		17002059	ВЕРХНЯ ЧАСТИНА ЛІЙКИ ВИДАЧИ КАВИ <i>OP.EROG.CAF.SMR NER/OP.</i>
	15		421944008261	M/BLK COF.DISPEN.MOBILE PART SMR ASSY. <i>M/BLK COF.DISPEN.MOBILE PART SMR ASSY.</i>
	15		421944065141	M/BLK COF.DISPEN.MOBILE PART V2 SMR <i>M/BLK COF.DISPEN.MOBILE PART V2 SMR</i>
	16		421944017631	ВЕРХНЯ ЧОРНА КРИШКА ДІСПЕНСОРА ВИДАЧИ КАВИ <i>BLK COFFEE DISPENSER BODY LID V3 SMR</i>
	17		421944017651	WHT COFFEE DISPENSER BODY SEALSMR <i>WHT COFFEE DISPENSER BODY SEAL SMR</i>
	18		17001849	BLK BREW UNIT COFFEE OUTLET CONNECT.SMR <i>BLK BREW UNIT COFFEE OUTLET CONNECT.SMR</i>
	19		17000955	TRANS.BREW UNIT COF.OUTLET CONN.TUBE SMR <i>TRANS.BREW UNIT COF.OUTLET CONN.TUBE SMR</i>
	19		421944065131	TRASP.SIL.COFFEE DISPENSER TUBE SMR <i>TUBO EROG.CAF.SMR SIL.TRASP.</i>
	20		17001022	BLACK COFFEE DISPENSER BODY SMR <i>BLACK COFFEE DISPENSER BODY SMR</i>
	20		421944065151	BLK COFFEE DISPENSER BODY V3 SMR <i>CORPO EROG.CAF.V3 SMR NER.</i>

# Model Machine

MACSAE168

KABOBAPKA OCS SAE LIRIKA OTC SIL 230/50 SCH(10004768 )

MACSAE168.T.0003



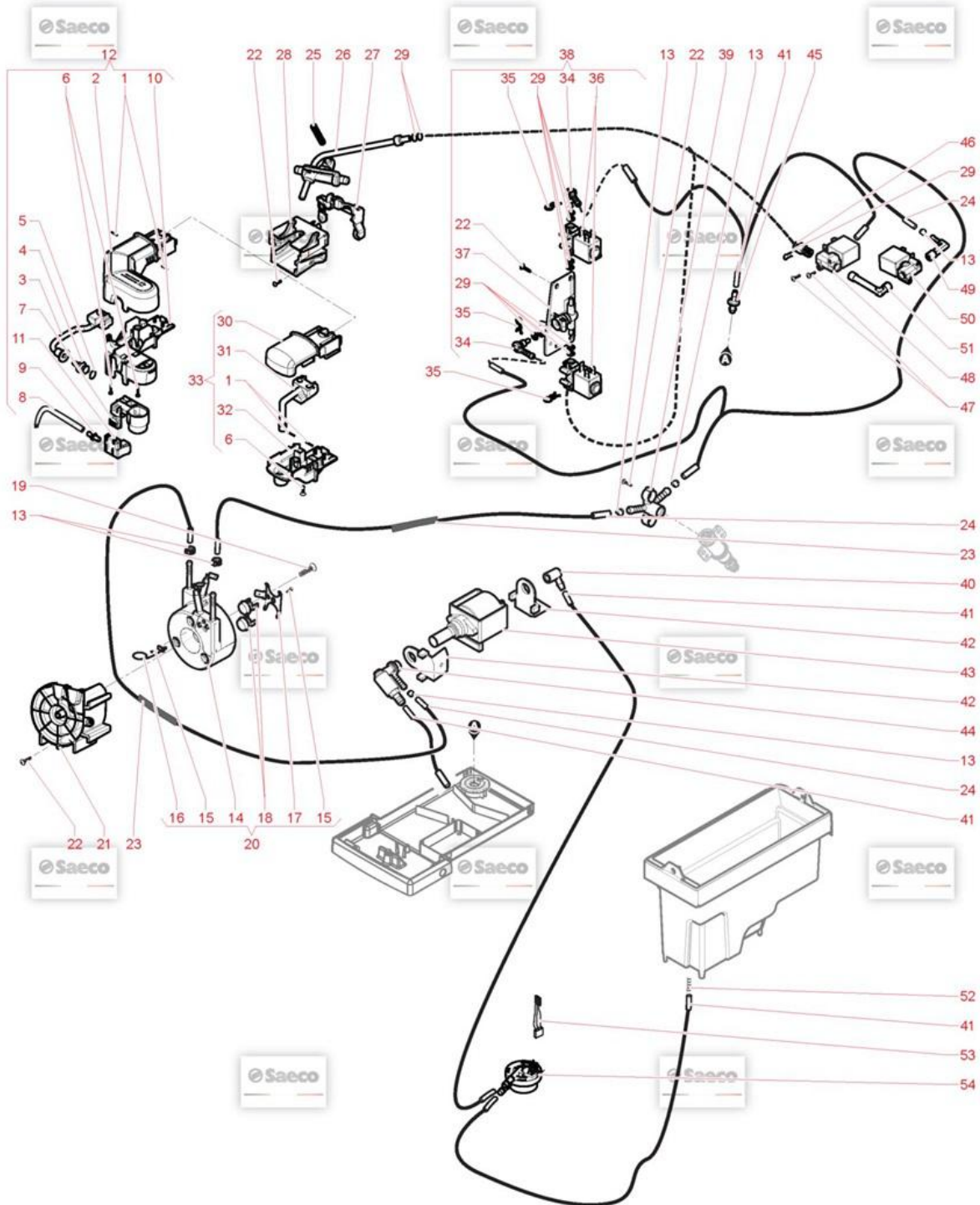



















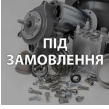

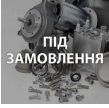

TAVOLA NR. 3 - ARTICOLO KABOBAPKA OCS SAE LIRIKA OTC SIL 230/50 SCH( 10004768 )



## Model Machine

MACSAE168











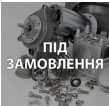

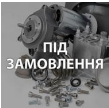













КАВОВАРКА OCS SAE LIRIKA OTC SIL 230/50 SCH(10004768 )

Web	Pos.	Foto	Item - Replace by	Description
				<i>Press - CTRL + CLICK go to item in a new window Натисніть - Ctrl + права кнопка миші щоб відкрити запчастину в новому вікні</i>
	1		11005395	STEEL MILK CONTAINER SUPPORT SPRING P124 <i>STEEL MILK CONTAINER SUPPORT SPRING P124</i>
	2		421944061611	M/BLK CAPPUCCINATORE COVER SMRO/PT ASSY <i>AS.COP.CAPPUCCINAT. SMRO/PT NER/OP.</i>
	3		421944048342	BLK CAPP.MILK DISPENSER TUBE V2 SMRO/PT <i>TUBO EROG.LATTE CAPP.V2 SMRO/PT NER.</i>
	4		421944008151	BLK VENTURI TUBE FOR CARAFE TRX5 <i>BLK VENTURI TUBE FOR CARAFE TRX5</i>
	5		NM01.028	O-RING 106 SILICONE <i>OR 106 SILICONE</i>
	6		12001431	SCREW TCB TORX 10 3X12 PLAST.SS <i>SCREW TCB TORX 10 3X12 PLAST.SS</i>
	7		421944057121	BLK/BRASS CARAFE CAPPUC.SMRC ASSY <i>BLK/BRASS CARAFE CAPPUC.SMRC ASSY</i>
	8		421944063591	SILICONE TUBE 3,5X6 L=340 MM <i>TUBO SILICONE 3.5X6 L=340MM TAGLIO V</i>
	9		17001362	BLK MILK INTAKE TUBE CONNECT.INS.V2 RYL <i>BLK MILK INTAKE TUBE CONNECT.INS.V2 RYL</i>
	10		421944048362	M/BLK LOW.CAPP.COVER V2 SMRO/PT <i>M/BLK LOW.CAPP.COVER V2 SMRO/PT</i>
	11		421944048351	BLK INLET CAPP.MILK BODY SMRO/PT <i>CORPO ENTRATA LATTE CAPP.SMRO/PT NER.</i>
	12		421944051123	BLK CAPPUCCINATORE S/SCR.V3 SMRO/PT ASSY <i>AS.CAPPUCCINATORE V3 SMRO/PT NER.SER.</i>
	13		12000892	ЗАЖИМ D.9,5 16700004 <i>OETIKER CLAMP D=9,5 16700004 ( L250 )</i>

## Model Machine

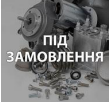
MACSAE168



























КАВОВАРКА OCS SAE LIRIKA OTC SIL 230/50 SCH(10004768 )

	14		<b>421944028841</b>	TUB.BOILER XS4 1900W 230V ASSY. <i>TUB.BOILER XS4 1900W 230V ASSY.</i>
	14		<b>421944046121</b>	TUB.BOILER XS4 1300W 120V ASSY. <i>AS.CALD.TUB.XS4 1300W 120V</i>
	15		<b>12001715</b>	SCREW TCB TORX 20 M4X8 AUTOFORMING ZN-B <i>SCREW TCB TORX 20 M4X8 AUTOFORMING ZN-B</i>
	16		<b>17800628</b>	TEMPERATURE SENSOR NTC UL L=550MM <i>TEMPERATURE SENSOR NTC UL L=550MM</i>
	17		<b>11001751</b>	TUB.BOILER V3 UPPER THERM.FIXING SPRING <i>TUB.BOILER V3 UPPER THERM.FIXING SPRING</i>
	18		<b>12001033</b>	ТЕРМОСТАТ 190°С БОЙЛЕРА ДЛЯ КОФЕВАРОК PHILIPS SAECO 12001033 <i>THERMOSTAT ONE SHOT 190°</i>
	19		<b>12001280</b>	SCREW TSP TORX 10 5X20 PLAST.ZN-B <i>SCREW TSP TORX 10 5X20 PLAST.ZN-B</i>
	20		<b>421944046301</b>	GEN.TUB.BOILER XS4 1900W 230V ASSY. <i>AS.GEN.CALD.TUB.XS4 1900W 230V</i>
	20		<b>421944055941</b>	GEN.TUB.BOILER XS4 GAG 1300W 120V ASSY <i>GEN.TUB.BOILER XS4 GAG 1300W 120V ASSY</i>
	21		<b>421944040831</b>	BLK SLIM TUB.BOILER SUPPORT V2SMR <i>BLK SLIM TUB.BOILER SUPPORT V2 SMR</i>
	22		<b>12000450</b>	SCREW TCB TORX 10 3,5X12 PLAST.ZN-N <i>SCREW TCB TORX 10 3,5X12 PLAST.ZN-N</i>
	23		<b>16000540</b>	TRANSPAR.11X12,8 SILICONE TUBE IN ROLL <i>TRANSPAR.11X12,8 SILICONE TUBE IN ROLL</i>
	24		<b>16000380</b>	5X8,9 SILICONE TUBE IN ROLL <i>5X8,9 SILICONE TUBE IN ROLL</i>
	25		<b>17000006</b>	TWO WAY TEFLON TUBES SUPPORT SPRING MYB9 <i>TWO WAY TEFLON TUBES SUPPORT SPRING MYB9</i>

## Model Machine

MACSAE168











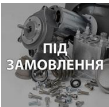

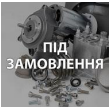













КАВОВАРКА OCS SAE LIRIKA OTC SIL 230/50 SCH(10004768 )

	26		421944029721	БІЛА ТЕФЛОНОВА ТРУБКА SUP.14 AS.SUPP.TUBO TEFL.PREF.145MM SMR/T BIA.
	27		421944008851	BLK CARAFE GRAFT BODY INSERT SMR/T INS.CORPO INNES.CARAF.SMR/T NER.
	28		421944008431	BLK CARAFE INSERT BODY SMR/T BLK CARAFE INSERT BODY SMR/T
	29	 ПІД ЗАМОВЛЕННЯ	140328059	OR 2015 SILICONE PTFE/FDA OR 2015 SILICONE PTFE/FDA
	30	 ПІД ЗАМОВЛЕННЯ	421944009041	M/BLK UPPER BODY HOT WATER DISP.SMR/T CORPO SUP.EROG.ACQ.CALDA SMR/T NER/OP.
	31	 ПІД ЗАМОВЛЕННЯ	17001215	BLACK HOT WATER DISPENSER TUBENPR/T BLACK HOT WATER DISPENSER TUBE NPR/T
	32	 ПІД ЗАМОВЛЕННЯ	421944009011	BLK LOWER BODY HOT WATER DISPENS.SMR/T BLK LOWER BODY HOT WATER DISPENS.SMR/T
	33		421941306191	НАСАДКА ВИДАЧИ ГОР ВОДЫ MINUTO SAECO 421941308711 BLK HOT WATER DISPENSER SMR/T ASSY.
	34	 ПІД ЗАМОВЛЕННЯ	421944059391	WHT CONNECT.FAST LOCK 90 SILIC.TUBE PPS RAC.FAST LOCK PPS 90°TUBO SIL.RETIN.BIA
	35		9011.144	SS FORK FOR TUBE D=4 FORCELLA X TUBO D.4
	36	 ПІД ЗАМОВЛЕННЯ	421946041361	2WAY SOLENOID PLASTIC VALVE D.2 24V 2WAY SOLENOID PLASTIC VALVE D.2 24V
	37	 ПІД ЗАМОВЛЕННЯ	421944074971	ELECTROV.SUPPORT W/CONNECT.LIRIKA OTC ELECTROV.SUPPORT W/CONNECT.LIRIKA OTC
	38	 ПІД ЗАМОВЛЕННЯ	421944074991	SOLE.N.VALVE LIRIKA OTC ASSY AS.ELETTROV.LIRIKA OTC

## Model Machine

MACSAE168











KABOBAPKA OCS SAE LIRIKA OTC SIL 230/50 SCH(10004768 )

	39	 ПІД ЗАМОВЛЕННЯ	421941279742	BLK CONNECTOR FOR PIN BOILER V2 SMR <i>RAC.PERNO CALD.SMR NER.</i>
	40	 ПІД ЗАМОВЛЕННЯ	11002149	BLACK PUMP OUTLET 90°CONNECTORP0049/A <i>BLACK PUMP OUTLET 90°CONNECTOR P0049/A</i>
	41		JS01.022	SILICONE TUBE 5X10 60SH IN ROLL <i>SILICONE TUBE 5X10 60SH IN ROLL</i>
	42		149205850	BLACK TYPE ULKA PUMP W/BEVEL SUPPORT <i>BLACK TYPE ULKA PUMP W/BEVEL SUPPORT</i>
	43	 ПІД ЗАМОВЛЕННЯ	12000140	PUMP 230V-50HZ <i>ULKA PUMP EP5/S GW 230V-50HZ</i>
	43	 ПІД ЗАМОВЛЕННЯ	12000142	POMPE 120V-60HZ <i>ULKA PUMP EAP5/S 120V-60HZ</i>
	43	 ПІД ЗАМОВЛЕННЯ	12000182	ULKA PUMP EP5/S GW 220V-60HZ <i>ULKA PUMP EP5/S GW 220V-60HZ</i>
	43	 ПІД ЗАМОВЛЕННЯ	421944081531	ULKA PUMP EFP5/S 120V-60HZ <i>ULKA PUMP EFP5/S 120V-60HZ</i>
	44		11024863	L-F/BR.SAFETY VALVE 16-18 BARASSY. <i>AS.VALV.SIC.16-18 BAR OT/L-F</i>
	45	 ПІД ЗАМОВЛЕННЯ	17001060	BLACK WATER DRAINAGE CONNECTORSMR/B-T <i>BLACK WATER DRAINAGE CONNECTOR SMR/B-T</i>
	46		11027572	L-F/BRASS CONNECTOR 1/8" FOR TUBE D=4 <i>RAC.1/8" CONICO X TUBO D=4 OT/L-F</i>
	47		129823802	TCB SCREW M4X8 UNI 7687 ZNP <i>VITE TCB M4X8 UNI 7687 ZNP</i>
	48		11024039	3WAY EV OT57 (31JN1XRV20-SXT+LBV05024CU) <i>3WAY EV OT57 (31JN1XRV20-SXT+LBV05024CU)</i>
	49		17001269	L-F/BRASS 90°CONNECT.FOR FAUCET EV.NPR/T <i>L-F/BRASS 90°CONNECT.FOR FAUCET EV.NPR/T</i>

## Model Machine

MACSAE168

КАБОБАРКА OCS SAE LIRIKA OTC SIL 230/50 SCH(10004768 )

	50		11024038	BRASS 2WAY EV 21JN1RRV20-XT+LBV05024CU <i>BRASS 2WAY EV 21JN1RRV20-XT+LBV05024CU</i>
	51		11031400	L-F/BRASS 90°CONNECTOR V2 FORFAUCET EV. <i>L-F/BRASS 90°CONNECTOR V2 FOR FAUCET EV.</i>
	52	 ПІД ЗАМОВЛЕННЯ	0701.081	SPRING FOR TUBE PRODUCT 1 <i>SPRING FOR TUBE PRODUCT 1</i>
	53	 LIBERTY UKRAINE	17800686	3POLES CONNECTOR FLOWMETER SMRUL <i>AS.CONN.3P.TURBINA SMR UL</i>
	54		NV99.099	TURBINE D=1,2 ASSY. <i>TURBINA DIGMESA FHKSC 1,2 ARNITE OC</i>



# Model Machine

MACSAE168

KABOBAPKA OCS SAE LIRIKA OTC SIL 230/50 SCH(10004768 )

MACSAE168.T.0004



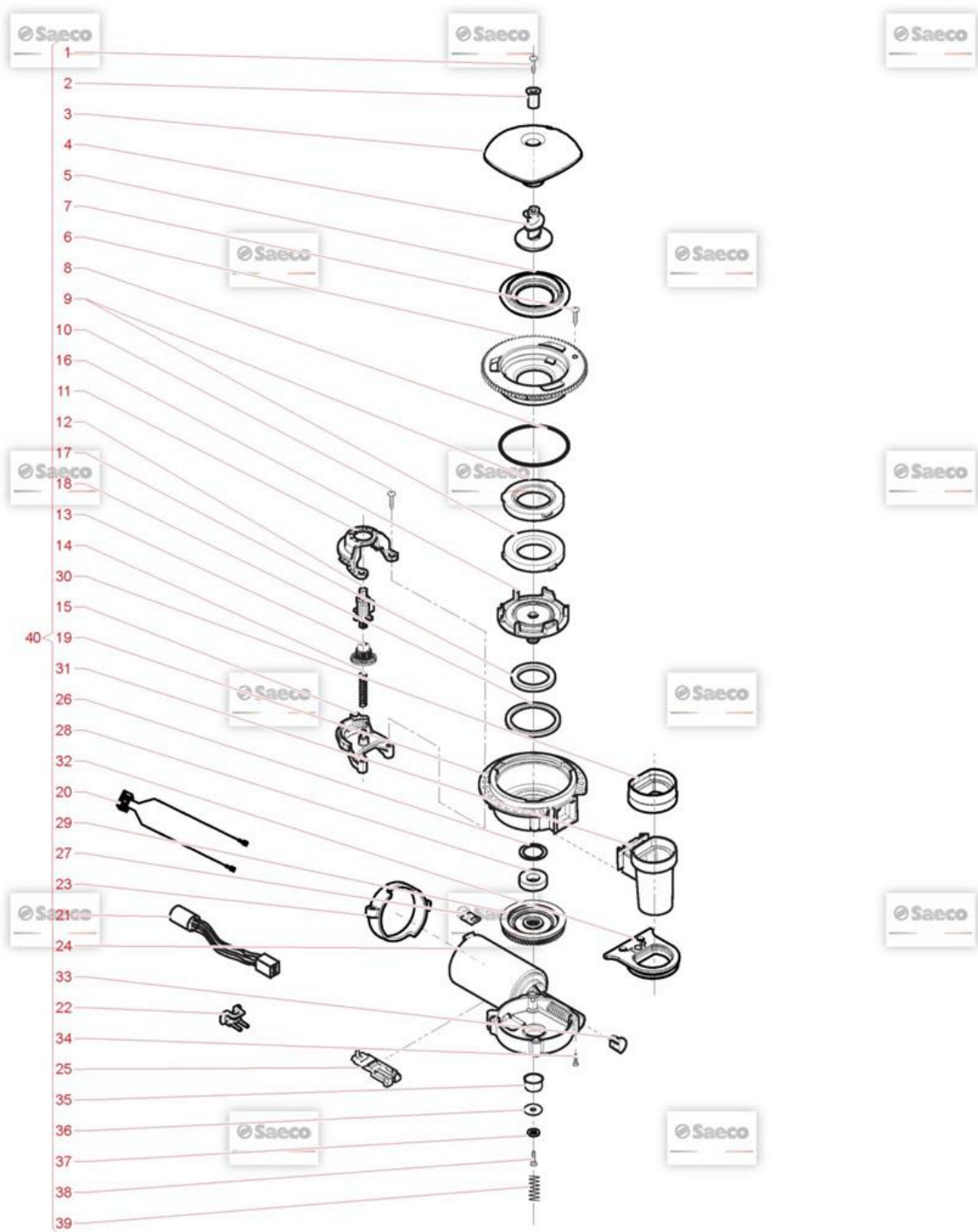























TAVOLA NR. 4 - ARTICOLO KABOBAPKA OCS SAE LIRIKA OTC SIL 230/50 SCH( 10004768 )



## Model Machine

MACSAE168



























КАВОВАРКА OCS SAE LIRIKA OTC SIL 230/50 SCH(10004768 )

Web	Pos.	Foto	Item - Replace by	Description
				<i>Press - CTRL + CLICK go to item in a new window Натисніть - Ctrl + права кнопка миші щоб відкрити запчастину в новому вікні</i>
	1		U043.004	ZN-B TCB TORX 20 M4X16 ZN-B VITE TCBC M4,0X16 UNI 7687 ZNP
	2		11012466	ЛАТУННА ВТУЛКА БУНКЕРУ P0057 BRASS BUSH BEAN CONT.FINGER PROTEC.P0057
	3		17001008	TRANS.BEAN CONTAIN.FINGER PROTECT.SMR UL TRANS.BEAN CONTAIN.FINGER PROTECT.SMR UL
	4		11010031	ЗМІЄВИДНИЙ ГВИНТ ДЛЯ КОВОМОЛКИ TEA/ZAMA INCREASE SCREW GRINDER
	5		421941085872	УПЛОТНИТЕЛЬ ДЛЯ КОФЕВАРКИ (КОФЕМАШИНЫ) SAECO PHILIPS P119... COFFEE GRINDER SEAL P119 GRY 7035
	6		421944053581	BLK COF.GRINDER UPPER GRINDERSUPPORT V3 BLK COF.GRINDER UPPER GRINDERSUPPORT V3
	7		12001622	SCREW TCB TORX B 3,5X9,5 SCHEET NIK SCREW TCB TORX B 3,5X9,5 SCHEET NIK
	8		140328960	OR ORM 0530-15 NBR FDA OR ORM 0530-15 NBR FDA
	9		146520100	BAKED CLAY GRINDER 48X28 BAKED CLAY GRINDER 48X28
	10		129914002	SCREW TCB TORX 10 3,5X16 PLAST.ZN-B SCREW TCB TORX 10 3,5X16 PLAST.ZN-B
	11		11002508	UPPER COFFEEGRINDER GEAR SUPPORT P124 UPPER COFFEEGRINDER GEAR SUPPORT P124
	12		421944025161	ЧОРНИЙ ПЛАСТИКОВИЙ РЕГУЛЯТОР КАВОВОЛКИ SAECO 11003446 YLW BEAN COFFEE GRINDER INSERT SMR
	13		11003784	COFFEE GRINDING ADJUSTMENT GEAR P0049 COFFEE GRINDING ADJUSTMENT GEAR P0049

## Model Machine

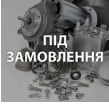
MACSAE168





















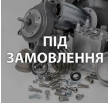

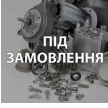

KABOBAPKA OCS SAE LIRIKA OTC SIL 230/50 SCH(10004768 )

	14		11002572	COFFEEGRINDER REGULATION SPRING P124 COFFEEGRINDER REGULATION SPRING P124
	15		11002613	LOWER COFFEEGRINDER GEAR SUPPORT P124 LOWER COFFEEGRINDER GEAR SUPPORT P124
	16		149198350	BLK LOWER COFFEEGRINDER GRINDER SUPPORT LOWER GRINDER SUPPORT COFFEEGRINDER
	17		123030300	AXIAL BEARING EKKO 342.35252 AXIAL BEARING EKKO 342.35252
	18		140360500	FELT RING 45,4X39,4X4 FELT RING 45,4X39,4X4
	19		142905450	ЗОВНІШНЯ ПЛАСТИКОВА ЧАСТИНА ДВИГУНА ГОРИЗОНТАЛЬНОЇ КАВО... BLK UPPER BODY WITH COFFEE GROUND OUTLET
	20	 ПІД ЗАМОВЛЕННЯ	421946000941	2P.CONN.COF.GRIND.MOTOR FUSE1.0A SMRO UL 2P.CONN.COF.GRIND.MOTOR FUSE1.0A SMRO UL
	20		421946004841	2P.CONN.COF.GRIND.MOTOR FUSE1.6A SMRO UL AS.CONN.2P.MOTORE MC FUS.1.6A SMRO UL
	21		17800687	ПРОВОД С РАЗЪЕМАМИ ДЛЯ ДАТЧИКА ХОЛА ГОРИЗОНТАЛЬНОЙ КОФЕ... 3POLES CONNECTOR MC SENSOR SMR UL
	22		17001921	BLK WIRING FIX INSERT FOR GRINDER BOARD BLK WIRING FIX INSERT FOR GRINDER BOARD
	23		11000194	BLACK COFFEEGRINDER MOTOR SUPPORT P124 BLACK COFFEEGRINDER MOTOR SUPPORT P124
	24	 ПІД ЗАМОВЛЕННЯ	11000511	MOTOR COFFEEGRINDER V3.1 120VASSY. AS.MOTORE MC V3.1 MOD=1.25 SX 120V
	24		11000513	MOTOR COFFEEGRINDER V3.1 230VASSY. MOTOR COFFEEGRINDER/V3.1 230V ASSY NUOVO PREZZO 14,3
	25		149199050	BLK SENSOR SUPPORT FOR COF.GRINDER MOTOR SUPP.SENS.TERMICO MOTORE MC NER.

## Model Machine

MACSAE168

KABOBAPKA OCS SAE LIRIKA OTC SIL 230/50 SCH(10004768 )

	26		128381800	STEEL CRINKLE WASHER 21,8X14X0,25 <i>STEEL CRINKLE WASHER 21,8X14X0,25</i>
	27		181540900	ELECTR.BOARD WITH SENSOR HAL506 SF-K <i>ELECTRONIC BOARD WITH SENSOR HAL506</i>
	28		123030200	RADIAL BEARING 61900.2RS1 <i>RADIAL BEARING 61900.2RS1</i>
	29		226000300	GEAR SX Z=38 FOR GRINDER MOTION ASSY. <i>GEAR SX Z=38 FOR GRINDER MOTION ASSY.</i>
	30		145854360	BLK GROUND COFFEE CONT.UPPER SEAL SMART1 <i>BLK GROUND COFFEE CONT.UPPER SEAL SMART1</i>
	31		11026355	BLK GROUND COFF.Outlet CONVEYOR V4 ASSY. <i>AS.CONVOGL. USCITA CAF.MAC.V4 SMART1 NER.</i>
	32		421944060561	GRY GROUND COF.CONT.LOWER SEALV2 SMART1 <i>GUARN.INF.CONT.CAF.MAC.V2 SMART1 GRI.</i>
	33		149214800	MC V3 MOD=1,25 WORM SCREW CENTRING CAP <i>MC V3 MOD=1,25 WORM SCREW CENTRING CAP</i>
	34		129661702	SCREW TCB TORX 3,5X30 PLAST.ZN-B <i>SCREW TCB TORX 3,5X30 PLAST.ZN-B</i>
	35		11002873	INSULATOR BUSH FOR GRINDER MOTOR P124 <i>INSULATOR BUSH FOR GRINDER MOTOR P124</i>
	36		128381902	STEEL FLAT WASHER DI=4,3 DE=14SP=1,5 <i>STEEL FLAT WASHER DI=4,3 DE=14 SP=1,5</i>
	37		128310402	GALV.WASHER UNI 8842 A4 <i>GALV.WASHER UNI 8842 A4</i>
	38		129574802	SCREW TCB TORX 20 M4X30 ZN-B <i>SCREW TCB TORX 20 M4X30 ZN-B</i>

## Model Machine

MACSAE168

КАВОВАРКА OCS SAE LIRIKA OTC SIL 230/50 SCH(10004768 )



39



11000597

STEEL COF.GRINDER SUPPORT SPRING P124  
*COFFEE GRINDER SUPPORT SPRING P124*



40

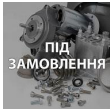

421944054591

GEN.MOTOR COF.GRINDER V2 SMRO120V ASSY  
*GEN.MOTOR COF.GRINDER V2 SMRO120V ASSY*



40

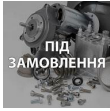

421944054611

GEN.MOTOR COF.GRINDER V2 SMRO230V ASSY  
*GEN.MOTOR COF.GRINDER V2 SMRO 230V ASSY*

# Model Machine

MACSAE168

KABOBAPKA OCS SAE LIRIKA OTC SIL 230/50 SCH(10004768 )

MACSAE168.T.0005

TAVOLA NR. 5 - ARTICOLO KABOBAPKA OCS SAE LIRIKA OTC SIL 230/50 SCH( 10004768 )

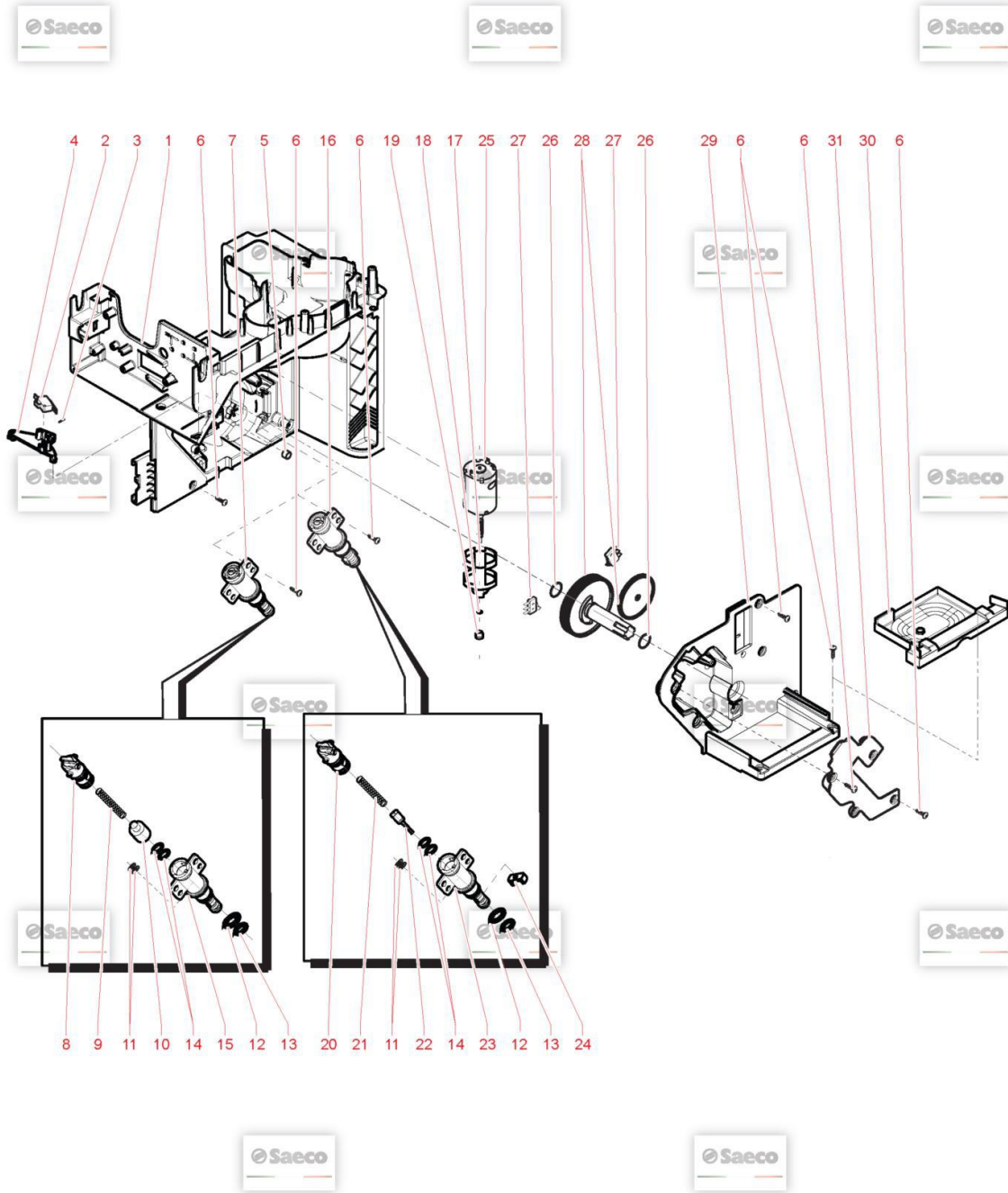

## Model Machine

MACSAE168

КАВОВАРКА OCS SAE LIRIKA OTC SIL 230/50 SCH(10004768 )

Web Pos. Foto Item - Replace by Description



Press - CTRL + CLICK go to item in a new window  
Натисніть - Ctrl + права кнопка миші щоб відкрити запчастину в новому вікні



1



421944043602

BLK RATIOMOTOR MOUNTING PLATEV2 SMRG AS  
BLK RATIOMOTOR MOUNTING PLATE V2 SMRG AS



2



12001890

MICROSWITCH XG/V3D  
MICROSWITCH XG/V3D



3

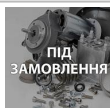

421944006861

STEEL SPRING FOR MICRO COMPENSATOR SMR  
STEEL SPRING FOR MICRO COMPENSATOR SMR



4

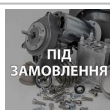

17001508

BLACK MICRO COMPENSATOR SMR  
BLACK MICRO COMPENSATOR SMR



5



9161.111

MAGNET FOR FLOAT SUPERAUT.  
MAGNET FOR FLOAT SUPERAUT.



6



12001728

SCREW TCBR TORX 10 3,5X12 PLAST.SS  
SCREW TCBR TORX 10 3,5X12 PLAST.SS



7



421946011491

BLK PIN FOR BOILER VALVE 4BARASSY.  
AS.PERNO CALD.VALV.4BAR NER.



8

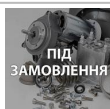

421944027691

BLK CAP FOR PIN BOILER VALVE 4BAR  
BLK CAP FOR PIN BOILER VALVE 4BAR



9

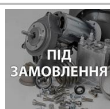

421944036701

SPRING FOR PIN BOILER VALVE 4BAR  
SPRING FOR PIN BOILER VALVE 4BAR



10

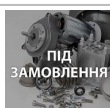

421944038251

MUSHROOM VALVE FOR FLOW SELECT.V2 P0057  
MUSHROOM VALVE FOR FLOW SELECT.V2 P0057



11

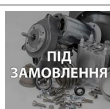

140328059

OR 2015 SILICONE PTFE/FDA  
OR 2015 SILICONE PTFE/FDA



12



NM01.035

OR ORM 0090-20 SILICONE  
OR ORM 0090-20 SILICONE



13

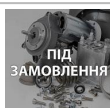













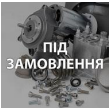













NM01.057

OR ORM 0050-20 IN SILICONE  
OR ORM 0050-20 IN SILICONE

## Model Machine

MACSAE168

KABOBAPKA OCS SAE LIRIKA OTC SIL 230/50 SCH(10004768 )







	14		140324459	OR ORM 0060-20 SILICONE PTFE/FDA <i>OR ORM 0060-20 IN SILICONE PTFE/FDA</i>
	15		421944027711	BLK PIN FOR BOILER VALVE 4BAR <i>BLK PIN FOR BOILER VALVE 4BAR</i>
	16		11005060	PIN V2 FOR BOILER ASSY. <i>PIN V2 FOR BOILER P119 ASSY. NUOVO PREZZO 8,37</i>
	17		9121.044	ANTIVIBRATION FOR MOTOR <i>ANTIVIBRANTE X MOTORE</i>
	18		148380200	BAKELIZZATE WASHER D=5,5 <i>BAKELIZZATE WASHER D=5,5</i>
	19		9121.046	BRONZE SINTERED BUSH FOR MOTORRATIOMOT. <i>BRONZE SINTERED BUSH FOR MOTOR RATIOMOT.</i>
	20		11003820	BLACK CAP V2 FOR PIN BOILER P119 <i>BLACK CAP V2 FOR PIN BOILER P119</i>
	21		9011.132	SS SPRING FOR PIN <i>MOLLA X SPILLO</i>
	22		421944028601	L-F/BR.PISTON L=20,9 ASSY. <i>L-F/BR.PISTON L=20,9 ASSY.</i>
	23		11003801	NAT.PIN V2 FOR BOILER P119 <i>NATURAL PIN V2 FOR BOILER P119</i>
	24		11005099	NATURAL CURSOR V2 FOR BOILER P119 <i>NATURAL CURSOR V2 FOR BOILER P119</i>
	25		11005214	MOTOR FOR RATIOMOTOR ASSY. <i>MOTOR FOR RATIOMOTOR P124 ASSY</i>
	26		9161.132	MYLAR WASHER FOR RATIOMOTOR <i>MYLAR WASHER FOR RATIOMOTOR</i>
	27		421946025541	MICROSWITCH XC/SM1 V2 <i>MICROSWITCH XC/SM1 V2</i>

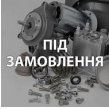

## Model Machine

MACSAE168

КАВОВАРКА OCS SAE LIRIKA OTC SIL 230/50 SCH(10004768 )

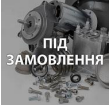
	28		20000900	SPARES KIT GEARS FOR RATIOMOTOR V2 <i>SPARES KIT GEARS FOR RATIOMOTOR V2</i>
	29	 ПІД ЗАМОВЛЕННЯ	421941287512	BLK RATIOMOT.MOUNTING PLATE COVER V2 SMR <i>BLK RATIOMOT.MOUNTING PLATE COVER V2 SMR</i>
	30		421944062701	BLK BREW UNIT DRAWER COFFEE V2SMR <i>BLK BREW UNIT DRAWER COFFEE V2 SMR</i>
	31	 ПІД ЗАМОВЛЕННЯ	17000730	BLACK BOILER SEAT PIN COVER SMR <i>BLACK BOILER SEAT PIN COVER SMR</i>

# Model Machine

MACSAE168

KABOBAPKA OCS SAE LIRIKA OTC SIL 230/50 SCH(10004768 )

MACSAE168.T.0006



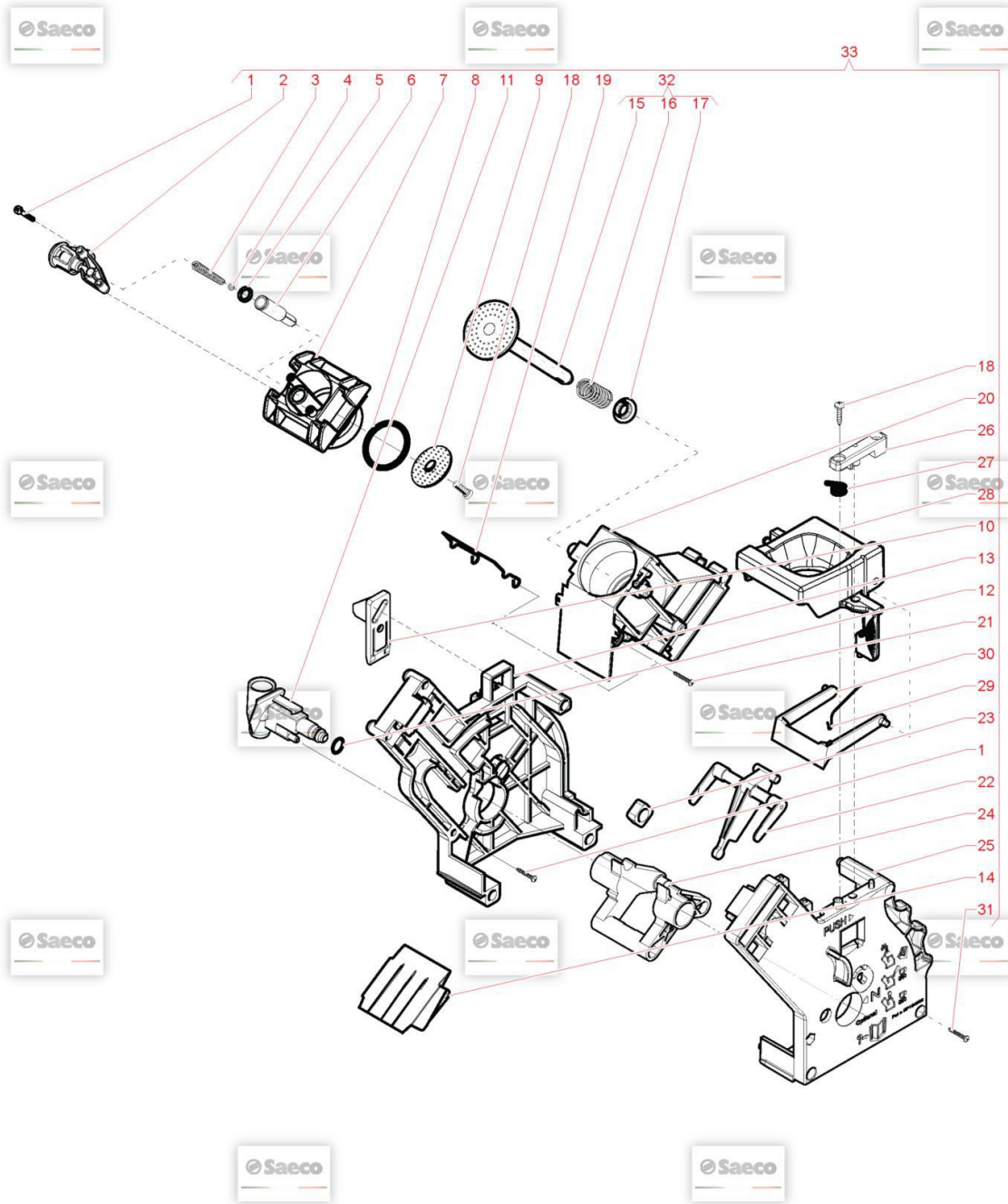























TAVOLA NR. 6 - ARTICOLO KABOBAPKA OCS SAE LIRIKA OTC SIL 230/50 SCH( 10004768 )



## Model Machine

MACSAE168



























КАВОВАРКА OCS SAE LIRIKA OTC SIL 230/50 SCH(10004768 )

Web	Pos.	Foto	Item - Replace by	Description
				<i>Press - CTRL + CLICK go to item in a new window Натисніть - Ctrl + права кнопка миші щоб відкрити запчастину в новому вікні</i>
	1		12000550	CAMOPI3 TCB TORX 10 3X25 PLAST.SS SCREW TCB TORX 10 3X25 PLAST.SS
	2		421944065221	BLK BREW UNIT COF.OUTLET SLEEVE SMR ASSY BLK BREW UNIT COF.OUTLET SLEEVE SMR ASSY
	3		11012095	ПРУЖИНА КОНТРПОРШНЯ РОБОЧОГО БЛОКУ SAECO 421944082361 SS COFFEE UNIT CONTERPISTON SPRING S0053
	3		9161.222	SS.CONICAL SPRING MOLLA CONICA
	4	 ПІД ЗАМОВЛЕННЯ	421944034451	BOROSILICATE SPHERE D.5 MM BOROSILICATE SPHERE D.5
	5	 LIBERTY UKRAINE	140328761	OR ORM 0060-15 TERMOIL OR ORM 0060-15 TERMOIL
	6	 ПІД ЗАМОВЛЕННЯ	11009276	BLK COUNTER PISTON TUBE BREW UNIT S0053 BLK COUNTER PISTON TUBE BREW UNIT S0053
	7		11001840	BLACK COUNTER PISTON BREW UNIT8GR.P124 CONTROPIST.GRUP.8GR.P124 NER.
	8		NM01.044	OR ORM 0320-40 SILICONE PTFE/FDA OR ORM 0320-40 SILICONE PTFE
	9		9161.268	PERCOLATOR DE=35,8 ELFO PERCOLATOR DE=35,8 ELFO
	10	 ПІД ЗАМОВЛЕННЯ	421944046931	YLW BREW UNIT COUPLING PLATE V2 SMART YLW BREW UNIT COUPLING PLATE V2 SMART
	11		9161.064.050	BLACK WATER INLET SLEEVE BREWUNIT ROYAL BLACK WATER INLET SLEEVE BREW UNIT ROYAL
	12		NM02.007	OR 2025 IN TERMOIL OR 2025 TERMOIL

## Model Machine

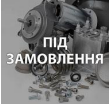
MACSAE168

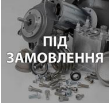











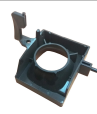

КАВОВАРКА OCS SAE LIRIKA OTC SIL 230/50 SCH(10004768 )

	13		9161.375.050	BLACK BREW UNIT REAR PLATE SMART <i>BLACK BREW UNIT REAR PLATE SMART</i>
	14		17000737	ЧОРНА НАКЛАДКА РОБ. ГР. ДЛЯ ВИДАЛЕННЯ ЖМИХУ L=56,3 <i>BLACK BREW UNIT CONVEYOR SLIDE L=56,3</i>
	15		421944065791	GRY BREW UNIT INTEGR.PISTON 8GR.V3 ASSY <i>GRY BREW UNIT INTEGR.PISTON 8GR.V3 ASSY</i>
	16		9161.198	SS.8GR.BREW UNIT PISTON SPRING <i>SS.8GR.BREW UNIT PISTON SPRING</i>
	17		9161.191	WHITE 8GR.-12GR.BREW UNIT PISTON BUSH <i>BOCCOLA X PISTONE NEUTRO</i>
	18		12000895	SCREW TSP TORX 10 3X10 PLAST.SS <i>SCREW TSP TORX 10 3X10 PLAST.SS</i>
	19		11001556	SS BREW UNIT SPRING H=49 SMART <i>SS BREW UNIT SPRING H=49 SMART</i>
	20		421944014611	BLK COF.CONTAIN.BREW UNIT V2 M5000 ASSY. <i>BLK COF.CONTAIN.BREW UNIT V2 M5000 ASSY.</i>
	21		129912521	SCREW TCBR TORX 10 3,5X14 PLAST.SS <i>SCREW TCBR TORX 10 3,5X14 PLAST.SS</i>
	22		11003078	BLACK CONNECTING ROD BREW UNIT8GR. <i>BLACK CONNECTING ROD BREW UNIT 8GR.</i>
	23		9161.094.050	BLACK BREW UNIT DRILLED BLOCK <i>BLACK BREW UNIT DRILLED BLOCK</i>
	24		421944051231	YLW BREW UNIT ELBOW SHAFT M5000 <i>YLW BREW UNIT ELBOW SHAFT M5000</i>
	25		11005920	BLACK BREW UNIT FRONT PLATE S/SCR.SMART <i>PIAS.ANT.GRUP.S/F.SMART NER.SER.NEW</i>
	26		421944050711	YLW BREWUNIT HOPPER BLOCKING PLATE SMART <i>YLW BREWUNIT HOPPER BLOCKING PLATE SMART</i>

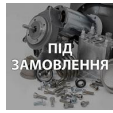
## Model Machine

MACSAE168

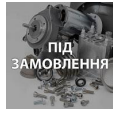
КАВОВАРКА OCS SAE LIRIKA OTC SIL 230/50 SCH(10004768 )

	27		9161.378	SS HOPPER SPRING FOR BREW UNITSMART <i>SS HOPPER SPRING FOR BREW UNIT SMART</i>
	28		149261350	BLACK HOPPER DOSER BREW UNIT SMART1 <i>BLACK HOPPER DOSER BREW UNIT SMART1</i>
	29		9161.046	ПРУЖИНА ВОРОНКИ ЗАВАРОЧНОГО БЛОКА ДЛЯ КОФЕМАШИН PHILIPS ... <i>MOLLA X RASATORE GRUPPO</i>
	30		11004161	BLACK SCRAPER FOR BREW UNIT M5000 <i>BLACK SCRAPER FOR BREW UNIT M5000</i>
	31		12000897	SCREW TCB TORX 10 3,5X20 PLAST.SS <i>SCREW TCB TORX 10 3,5X20 PLAST.SS</i>
	32		421944065811	НИЖНІЙ ПОРШЕНЬ РОБОЧОГО БЛОКУ 8GR. V3 ВЗБОРІ <i>AS.GEN.PIST.INTEGR.GRUP.CAF.8GR.V3 GRI.</i>
	33		421944052401	BLK/YLW BREW UNIT 8GR.5BAR SMR <i>BLK/YLW BREW UNIT 8GR.5BAR SMR</i>
	33		421944052461	BLK/YLW BREW UNIT 8GR.8BAR V3SMR <i>BLK/YLW BREW UNIT 8GR.8BAR V3 SMR</i>