

# Model Machine

MACSAE341

ВЕНДІНГ DIAMANTE RST BLK(10004840 )

MACSAE341.T.0001



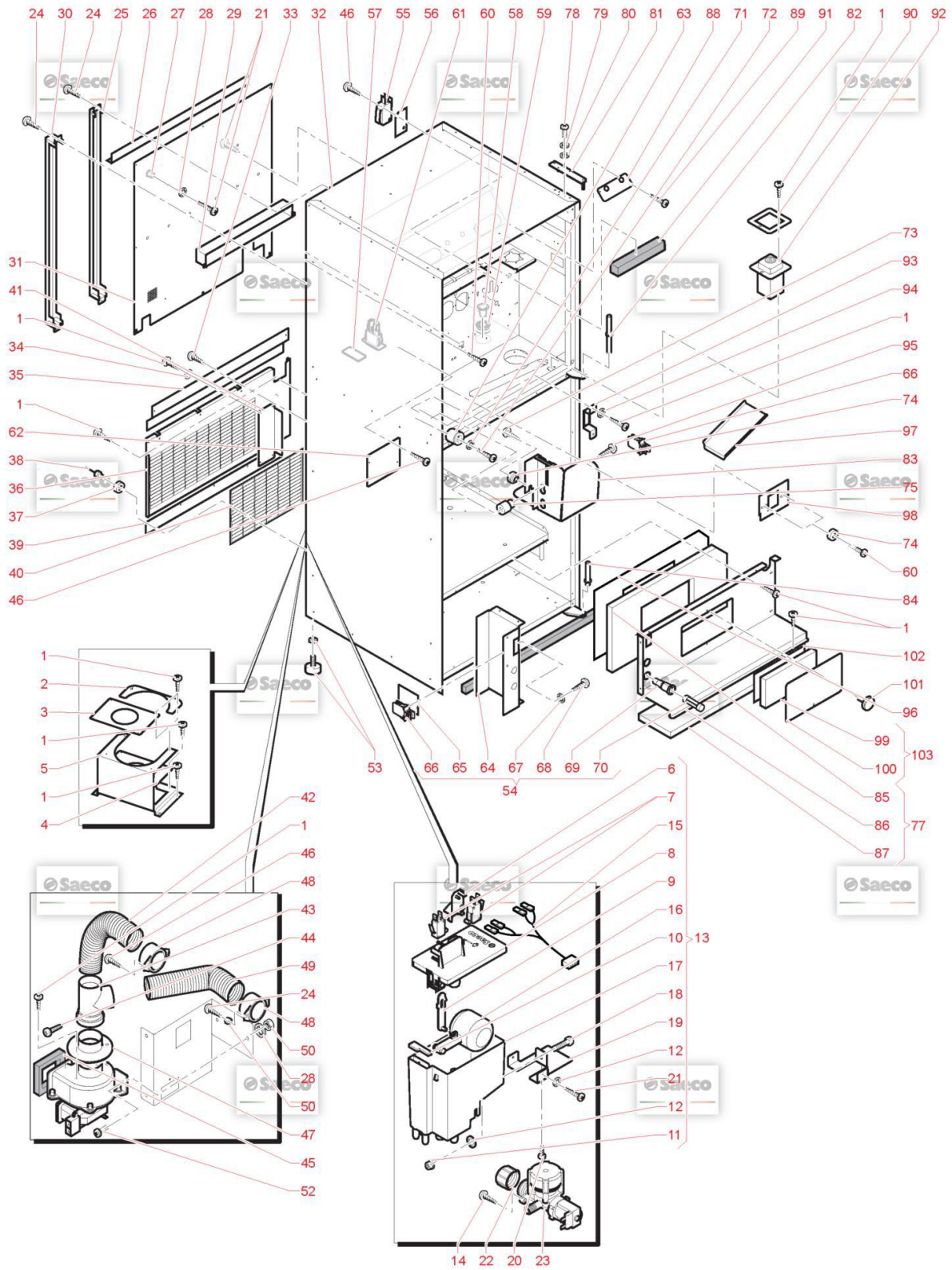





















TAVOLA NR. 1 - ARTICOLO ВЕНДІНГ DIAMANTE RST BLK( 10004840 )

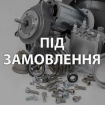

## Model Machine

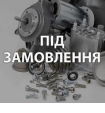
MACSAE341











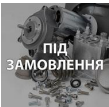

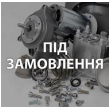













ВЕНДІНГ DIAMANTE RST BLK(10004840 )

Web	Pos.	Foto	Item - Replace by	Description
				<i>Press - CTRL + CLICK go to item in a new window Натисніть - Ctrl + права кнопка миші щоб відкрити запчастину в новому вікні</i>
	1		9161.207.150	GREY FAUCET MICRO SUPPORT M5000 <i>SUPPORTO X MICRO RUBINETTO</i>
	2		NE05.062	MICROSWITCH + WHEEL <i>MICROINTERRUTTORE C/ROTELLA</i>
	3		9111.623	LID TANK AIR BREAK <i>COPERCHIO X SERBATOIO AIR BREAK</i>
	4		9111.621	CONNECTING ROD TANK WATER <i>CONNECTING ROD TANK WATER</i>
	5	 ПІД ЗАМОВЛЕННЯ	9111.632	RUBBER FOR AIR BREAK <i>RUBBER FOR AIR BREAK</i>
	6	 ПІД ЗАМОВЛЕННЯ	U207.009	PLAIN WASHER 5,5X15 UNI 6593 GA <i>PLAIN WASHER 5,5X15 UNI 6593 GA</i>
	7	 ПІД ЗАМОВЛЕННЯ	U324.003	NUT M5 FLANGED INDENTED BASE <i>NUT M5 FLANGED INDENTED BASE</i>
	8	 ПІД ЗАМОВЛЕННЯ	11006703	ASSEMBLY AIR BREAK CRISTALLO400 <i>ASSEMBLY AIR BREAK CRISTALLO400</i>
	9		U143.022	SCREW T.M.T. K.F.R. 3,5X9,5 ZNP <i>VITE T.M.T. K.F.R. 3,5X9,5 ZNP</i>
	10	 ПІД ЗАМОВЛЕННЯ	11011054	PIN FOR BOSS D.8 <i>PIN FOR BOSS D.8</i>
	11		U110.005	SCREW AUT.TCB 3,9X9,5 DIN 7981F <i>VITE AUT.TCB 3,9X9,5 DIN 798</i>
	12		NV03.002	КРИШКА КЛАПАНА ПОДАЧІ ВОДИ 3/4 <i>"CAP 3/4 "KAPSTO 800R 3/4""</i>

## Model Machine

MACSAE341

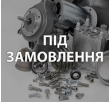











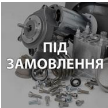



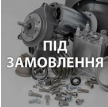







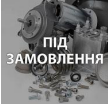

ВЕНДІНГ DIAMANTE RST BLK(10004840 )

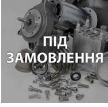
	13	 ПІД ЗАМОВЛЕННЯ	<b>U110.002</b>	SCREW AUT.TCB 3,5X13 DIN 7981F <i>SCREW AUT.TCB 3,5X13 DIN 7981 F</i>
	14	 ПІД ЗАМОВЛЕННЯ	<b>11033893</b>	HARNESS MICRO AIR BREAK CRS600EVO <i>HARNESS MICRO AIR BREAK CRS600EVO</i>
	15		<b>9111.508</b>	FLOAT FOR AIR BREAK BOWL <i>FLOAT FOR AIR BREAK BOWL</i>
	16	 ПІД ЗАМОВЛЕННЯ	<b>9111.641</b>	TANK AIR BREAK <i>SERBATOIO AIR BREAK C/FORO</i>
	17		<b>U043.015</b>	SCREW TCBC M5,0X12 UNI 7687 GALV. <i>SCREW TCBC M5,0X12 UNI 7687 GALV.</i>
	18		<b>1863.015</b>	AIR BREAK SUPPORT <i>AIR BREAK SUPPORT</i>
	19	 ПІД ЗАМОВЛЕННЯ	<b>1863.019.A20</b>	LOWER GUIDE RIGHT PLATE <i>LOWER GUIDE RIGHT PLATE</i>
	20		<b>9121.057.00P</b>	SAFETY ELECTROVALVE 24V DC <i>SAFETY ELECTROVALVE 24V DC</i>
	21	 ПІД ЗАМОВЛЕННЯ	<b>11034045</b>	BACK PANEL INSPECTION CRS EVO <i>BACK PANEL INSPECTION CRS EVO</i>
	22	 ПІД ЗАМОВЛЕННЯ	<b>11010659</b>	SPACER FOR DEFLECTOR <i>SPACER FOR DEFLECTOR</i>
	23		<b>129516803</b>	SCREW TCB3,5X19 DIN 7981 NICK <i>SCREW TCB3,5X19 DIN 7981 NICK</i>
	24	 ПІД ЗАМОВЛЕННЯ	<b>11010658</b>	AIR DEFLECTOR PLATE <i>AIR DEFLECTOR PLATE</i>
	25	 ПІД ЗАМОВЛЕННЯ	<b>11033150</b>	FS6N CHASSIS <i>FS6N CHASSIS</i>
	26		<b>NV01.002</b>	FOOT D.34 H.35 WITH NUT M10 <i>PIEDINO D.34 H.35 CON DADO M</i>

## Model Machine

MACSAE341

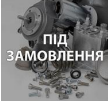













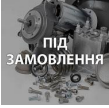





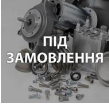

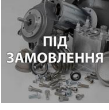

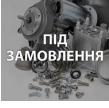
ВЕНДІНГ DIAMANTE RST BLK(10004840 )

	27		129824002	TCB SCREW M4X10 UNI 7687 ZNP <i>VITE TCB M4X10 UNI 7687 ZNP</i>
	28		11027979	ROD LOCK HOOKUP SEAGA <i>AGGANCIO ASTA X SERRATURA A 3 PUNTI</i>
	29		1863.073	DOOR SEAL FS400 <i>DOOR SEAL FS400</i>
	30		U043.014	SCREW TCBC M5,0X20 UNI 7687 GALV. <i>SCREW TCBC M5,0X20 UNI 7687 GALV.</i>
	31		9111.763.270	PIN <i>PIN</i>
	32		NV01.013	FOOT BUFFER D.20 X H10 <i>FOOT BUFFER D.20 X H10</i>
	33		U203.001	ШАЙБА 4,3X8 UNI 1749 GA <i>PLAIN WASHER 4,3X8 UNI 1749 GAL</i>
	34		12000780	SCREW TSPC M4,0X20 UNI 7688 GALV. <i>SCREW TSPC M4,0X20 UNI 7688 GALV.</i>
	35		11006477	FS400 DOOR PIVOT FOR WHEEL <i>FS400 DOOR PIVOT FOR WHEEL</i>
	36		11003474	FS400 DOOR WHEEL <i>FS400 DOOR WHEEL</i>
	37		NV01.014	RUBBER BUFFER FOR DOOR <i>GOMMINO PARACOLPI X PORTA</i>
	38		12002042	BUCKET UTILPLASTIC 328X250X300BLACK <i>BUCKET UTILPLASTIC 328X250X300 BLACK</i>
	39		11032654	BOTTOM TUB <i>BOTTOM TUB</i>
	40		11033011	BASEBOARD ASSEMBLY <i>BASEBOARD ASSEMBLY</i>

## Model Machine

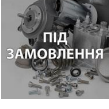
MACSAE341

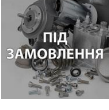
ВЕНДІНГ DIAMANTE RST BLK(10004840 )

	41		12002052	ZN-B TCB SCREW M4X16 <i>ZN-B TCB SCREW M4X16</i>
	42		NE16.002	GROMMET D.11X20,5XH.7 <i>GROMMET D.11X20,5XH.7</i>
	43	 ПІД ЗАМОВЛЕННЯ	1863.034	CHANNEL FOR DOOR CABLES <i>CHANNEL FOR DOOR CABLES</i>
	44	 Liberty	1863.035.A20	SUPPORT FOR MICRO DOOR <i>SUPPORTO MICRO PORTA</i>
	45		NE05.039	BIPOLAR MICROSWITCH <i>MICROINTERRUTTORE BIPOLARE</i>
	45	 ПІД ЗАМОВЛЕННЯ	NE05.061	MICROSWITCH CHERRY D413 .V3LD <i>MICROINT.BIPOLARE XTD 22AZ1</i>
	46	 ПІД ЗАМОВЛЕННЯ	11032297	MICRO ROOF <i>MICRO ROOF</i>
	46	 ПІД ЗАМОВЛЕННЯ	11032298	MICRO ROOF <i>MICRO ROOF</i>
	47		U116.006	SCREW AUT.PT TCB 3,5X12 WN 1441 ZNP <i>VITE AUT.PT TCB 3,5X12 WN 1441 ZNP</i>
	48		NE05.040	KEY FOR MICRO <i>CHIAVE X MICRO</i>
	49	 ПІД ЗАМОВЛЕННЯ	1863.016.A20	UPPER GUIDE LEFT PLATE <i>UPPER GUIDE LEFT PLATE</i>
	50	 ПІД ЗАМОВЛЕННЯ	1863.017.A20	LOWER GUIDE LEFT PLATE <i>LOWER GUIDE LEFT PLATE</i>
	51	 ПІД ЗАМОВЛЕННЯ	1863.018.A20	UPPER GUIDE RIGHT PLATE <i>UPPER GUIDE RIGHT PLATE</i>

# Model Machine

MACSAE341

ВЕНДІНГ DIAMANTE RST BLK(10004840 )

MACSAE341.T.0002

TAVOLA NR. 2 - ARTICOLO ВЕНДІНГ DIAMANTE RST BLK( 10004840 )

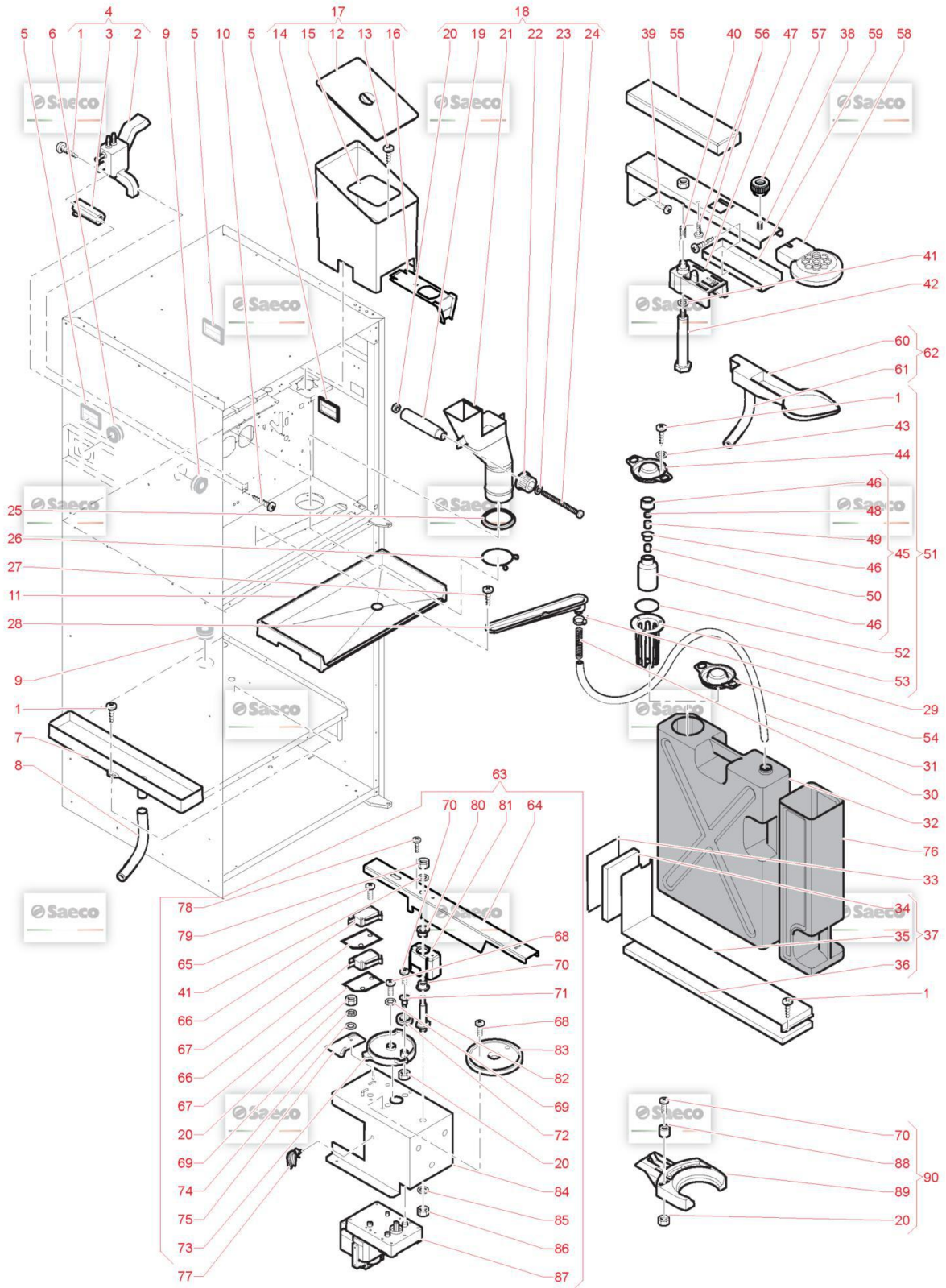

## Model Machine

MACSAE341

ВЕНДІНГ DIAMANTE RST BLK(10004840 )

Web Pos. Foto Item - Replace by Description



*Press - CTRL + CLICK go to item in a new window  
Натисніть - Ctrl + права кнопка миші щоб відкрити запчастину в новому вікні*



1



U315.001

NUT SQUARE M4 UNI 5596 GALV.  
NUT SQUARE M4 UNI 5596 GALV.



2



11030483

SYPHON  
SIFONE FORATO



3



U207.002

PLAIN WASHER 4,3X9 UNI 6592 GAL  
ROSETTA PIANA 4,3X9 UNI 6592 ZNP



4

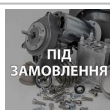

129825002

TCB SCREW M4X20 UNI 7687 ZNP  
TCB SCREW M4X20 UNI 7687 ZNP



5



11003905

ВЕНТИЛЯТОР 120 VL  
CENTRIFUGAL FAN 120V UL



5



9121.198.00A

ВЕНТИЛЯТОР ВИТЯЖКИ 07 120X100X100 SAECO 9121.198.00A  
VENTILATORE CENTRIFUGO CAP 07



6



U109.005

SCREW AUT.TCB 3,5X16 DIN 7981C  
VITE AUT.TCB 3,5X16 DIN 798



7

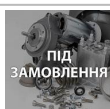

9111.708.A20

MAIN PLATE  
PIASTRA PRINCIPALE



8

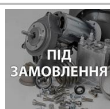

9111.766

CONNECTING PLATE  
CONNECTING PLATE



9

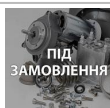

1883.004

SHEATH  
SHEATH



10



NE05.018

MICROSWITCH  
MICROINTERRUPTORE SAECO XCG5-81-P5



11

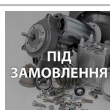

0862.014

ASPIRATOR TUBE L=290  
ASPIRATOR TUBE L=290



12















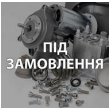













9111.640.060

TUBE CONNECTOR  
TUBE CONNECTOR

## Model Machine

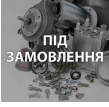
MACSAE341

БЕНДІНГ DIAMANTE RST BLK(10004840 )

















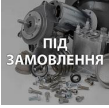







	13		<b>U116.006</b>	SCREW AUT.PT TCB 3,5X12 WN 1441 ZNP <i>VITE AUT.PT TCB 3,5X12 WN 1441 ZNP</i>
	14		<b>9111.732.A20</b>	SUPPORT <i>SUPPORT</i>
	15		<b>0862.145</b>	SPIRAL TUBE L.210MM <i>SPIRAL TUBE L.210MM</i>
	16		<b>9110.139</b>	COFFEE CONT. ASS. <i>ASS.CONTENITORE CAFFE'</i>
	17		<b>9111.728</b>	COVER FOR COFFEE CONTAINER <i>COPERCHIO CONTENITORE CAFFE'</i>
	18		<b>9111.724</b>	CONTAINER FOR COFFEE BEAN <i>CONTENITORE CAFFE' IN GRANI</i>
	19		<b>11000887</b>	WIRES SAFE PLATE <i>WIRES SAFE PLATE</i>
	20		<b>11000793</b>	MIXER ASPIRATION PLATE <i>MIXER ASPIRATION PLATE</i>
	21		<b>U023.009</b>	SCREW TCEI M5,0X30 UNI 5931 8.8 B <i>SCREW TCEI M5,0X30 UNI 5931 8.8 B</i>
	22		<b>11010736</b>	ASS.GUILLOTINE COFFEE (1813.027) <i>ASS.GUILLOTINE COFFEE</i>
	23		<b>9111.711</b>	INOX. PLATE <i>INOX. PLATE</i>
	24		<b>9111.717.270</b>	KNOB FIXING PLATE <i>KNOB FIXING PLATE</i>
	25		<b>U207.001</b>	PLAIN WASHER 5,3X10 UNI 6592 GAL <i>ROSETTA PIANA 5,3X10 UNI 6</i>
	26		<b>9111.481.060</b>	COLUMN CAP <i>COLUMN CAP</i>

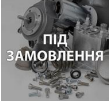

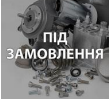
## Model Machine

MACSAE341











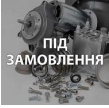

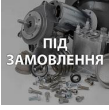





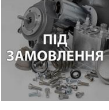

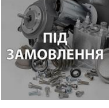

ВЕНДІНГ DIAMANTE RST BLK(10004840 )

	27		11011651	SOLUBLECONVEYOR TTT <i>SOLUBLECONVEYOR TTT</i>
	28		12002031	KNOB D.18 M5X15 <i>KNOB D.18 M5X15</i>
	29		9111.204	BUSH FOR SPRING COMPENSATE STIRRER <i>BOCCOLA X MOLLA BILANCERE PALETTE</i>
	30		11011713	CRISTALLO400 TTT CANISTER'L FIXING PLATE <i>CRISTALLO400 TTT CANISTER'L FIXING PLATE</i>
	30		9111.712	INOX. PLATE FOR MIXERS <i>INOX. PLATE FOR MIXERS</i>
	31		0862.112	GROUNDS SACK RING 8P <i>КОЛЬЦО ANELLO SACCO FONDI 8P</i>
	32		0862.111.050	GROUNDS DUCT <i>CONDOTTO X FONDI</i>
	33		9111.714.A20	TANK <i>TANK</i>
	34		11033202	NOZZLE ARM <i>NOZZLE ARM</i>
	34		11033203	UL ASSEMBLED NOZZLES ARM <i>UL ASSEMBLED NOZZLES ARM</i>
	35		11033186	SUPPORT NOZZLE ARM <i>SUPPORT NOZZLE ARM</i>
	36		9111.148	ELASTIC RING FOR FLOAT <i>ANELLO ELASTICO X GALLEGGIANTE</i>
	37		NE05.041	MICROSWITCH <i>MICROINTERRUTTORE</i>

## Model Machine

MACSAE341

ВЕНДІНГ DIAMANTE RST BLK(10004840 )

	38		9111.775	CHAIN CHAIN
	39		9111.130	FLOAT FOR DISCHARGE LEVEL FLOAT FOR DISCHARGE LEVEL
	40		9111.147	COUNTERWEIGHT FOR FLOAT CONTRAPPESO X GALLEGGIANTE
	41		9111.722	PLATE PIASTRA SUPPORTO BRACCIO
	42		140321560	O-RING 3187 NBR OR 3187 IN NBR
	43		9111.710.A20	NOZZLE ARM BRACCIO GIREVOLE
	44		129512903	SCREW TCB PH-AB 2,9X13 UNI 6954 NI SCREW TCB PH-AB 2,9X13 UNI 6954 NI
	45		9111.719	PLATE PLATE
	46		U109.003	SCREW TCB 3,5X9,5 DIN 7981 C NICK SCREW TCB 3,5X9,5 DIN 7981 C NICK
	47		0875.150	RUBBER FOR DISPENSING COMP. RUBBER FOR DISPENSING COMP.
	48		11001454	PVC TUBE 16X22 L.350 MM TUBO PVC 16X22 L.180MM
	49		NV01.009	RUBBER BUFFER GOMMINO PARACOLPI
	50		9111.723	PLATE PIASTRA X BRACCIO
	51		U116.002	SCREW AUT.PT TCB 3,5X16 WN 1441 SCREW AUT.PT TCB 3,5X16 WN 1441

## Model Machine

MACSAE341

ВЕНДІНГ DIAMANTE RST BLK(10004840 )



52



NE05.010

MICROSWITCH

*MICROINTERRUPTORE*



53



11033191

GEARMOTOR MECHTEX 25 RPM

*MOTORIDUTTORE MECHTEX 25 RPM*



54



9111.716.A20

CAM ARM

*CAMMA BRACCIO*



55



9111.715

CONNECTING ROD ARM

*BIELLA BRACCIO*



56

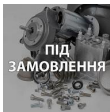

11033193

SPACER MOTOR ARM

*SPACER MOTOR ARM*

# Model Machine

MACSAE341

ВЕНДІНГ DIAMANTE RST BLK(10004840 )

MACSAE341.T.0003

TAVOLA NR. 3 - ARTICOLO ВЕНДІНГ DIAMANTE RST BLK( 10004840 )

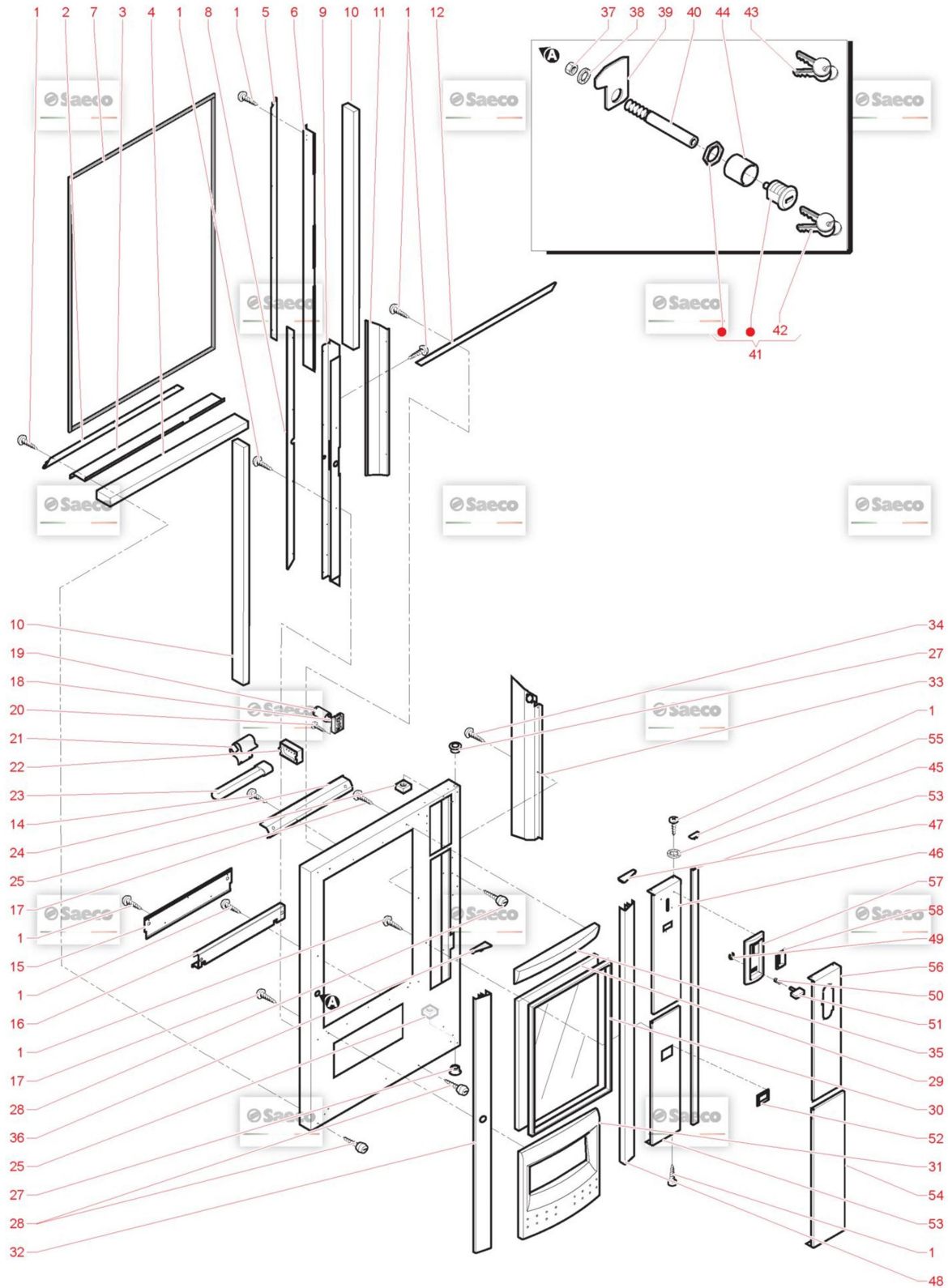

## Model Machine

MACSAE341

БЕНДІНГ DIAMANTE RST BLK(10004840 )

Web Pos. Foto Item - Replace by Description



Press - CTRL + CLICK go to item in a new window  
Натисніть - Ctrl + права кнопка миші щоб відкрити запчастину в новому вікні



1



U044.013

SCREW TSPC M4,0X12 UNI 7688 GALV.  
VITE TSPC M4,0X12 UNI 7688 ZNP



1

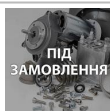

U110.002

SCREW AUT.TCB 3,5X13 DIN 7981F  
SCREW AUT.TCB 3,5X13 DIN 7981 F



2

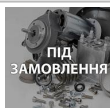

0875.365

SUP.COIN BOX  
SUP.COIN BOX



3



123160502

GALVANIZED NUT M5 HIGH UNI 5587-68  
GALVANIZED NUT M5 HIGH UNI 5587-68



4

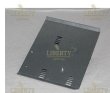

0875.357

ASS.FIXING PLATE COIN BOX  
ASS.FIXING PLATE COIN BOX



5

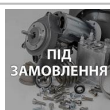

12002033

KNOB D.18 M5X25  
KNOB D.18 M5X25



6



9111.614

COIN BOX ANCHORING PIN  
COIN BOX ANCHORING PIN



7



U110.005

SCREW AUT.TCB 3,9X9,5 DIN 7981F  
VITE AUT.TCB 3,9X9,5 DIN 798



8



1602.147

BUSH FOR DOOR CONNECTING ROD  
BUSH FOR DOOR CONNECTING ROD



9

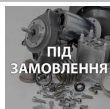

11032971

COIN BOX SUPPORT  
COIN BOX SUPPORT



10



123160302

NUT M3 HIGH UNI 5587 GALVANIZED  
NUT M3 HIGH UNI 5587 GALVANIZED



11

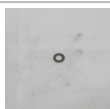

U207.003

PLAIN WASHER 3,2X7 UNI 6592 GALV.  
PLAIN WASHER 3,2X7 UNI 6592 GALV.



12

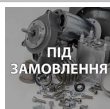











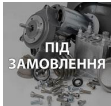



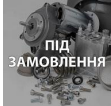



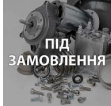

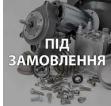

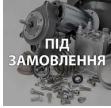

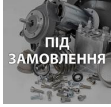

11032973

SUPPORT COIN BOX  
ASS.SUPP.GETTONIERA RENDIRESTO FS4N

## Model Machine

MACSAE341

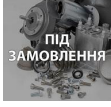





















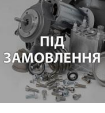

БЕНДІНГ DIAMANTE RST BLK(10004840 )

	13		<b>20007333</b>	KEY MERONI 337 <i>KEY MERONI 337</i>
	14		<b>12001902</b>	LOCK MERONI 337 <i>LOCK MERONI 337</i>
	15		<b>11031071</b>	LEVER FOR LOCK <i>LEVER FOR LOCK</i>
	16		<b>NF11.026</b>	EXPANSION RIVET D.3,9X8 ALU. <i>RIVETTO AD ESPANSIONE D.3,9X8 ALL.</i>
	17		<b>11011665</b>	COIN BOX HOPPER <i>COIN BOX HOPPER</i>
	18		<b>11032960</b>	COVER COIN BOX <i>COVER COIN BOX</i>
	19		<b>11032962</b>	COIN BOX CASE LID <i>COIN BOX CASE LID</i>
	20		<b>0875.271</b>	HANDLE FOR COIN CASE <i>HANDLE FOR COIN CASE</i>
	21		<b>11032967</b>	MONEY BOX ASSEMBLY <i>MONEY BOX ASSEMBLY</i>
	22		<b>1863.013</b>	LENS FOR COMPARTMENT DISPENSER <i>LENTE X VANO EROGAZIONE</i>
	23		<b>U019.005</b>	STEI SCREW M5,0X10 UNI 5923 GALV. <i>VITE STEI M5,0X10 UNI 5923 Z</i>
	24		<b>11032880</b>	FS4N GRILL <i>FS4N GRILL</i>
	25		<b>11032969</b>	DISPENSING COMPARTMENT FS4N <i>DISPENSING COMPARTMENT FS4N</i>
	25		<b>11034874</b>	DISPENSING COMPARTMENT CRS EVOD.80 <i>ASS.VANO EROGAZIONE CRS EVO D.80</i>

## Model Machine

MACSAE341























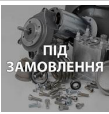

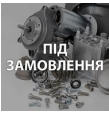

ВЕНДІНГ DIAMANTE RST BLK(10004840 )

	26		1863.024	STIRRUP FOR COMPARTMENT DISPENSER STAFFA X VANO EROGATORE
	27		U109.022	SCREW AUT.TCB 4,2X13 DIN 7981C SCREW AUT.TCB 4,2X13 DIN 7981 C
	28		9111.368.050	VARIABLE CUP SUPPORT BLACK SUPPORTO BICCHIERE VARIABILE
	29		11027365	COMPARTMENT DISPENSER MILLED COMPARTMENT DISPENSER MILLED
	29		1863.012.050	COMPARTMENT DISPENSER VANO EROGAZIONE
	30		1863.023.050	WATER DRIP TRAY VASCA X VANO EROGAZIONE
	31		U109.023	SCREW AUT.TCB 4,2X9,5 DIN 7981C SCREW AUT.TCB 4,2X9,5 DIN 7981 C
	32		U324.003	NUT M5 FLANGED INDENTED BASE NUT M5 FLANGED INDENTED BASE
	33		U043.007	SCREW TCBC M3,0X8 UNI 7687 GALV. SCREW TCBC M3,0X8 UNI 7687 GALV.
	34		12002039	SCREW TCBD TORX 20 M4X12 ZN-B VITE TCBD TORX 20 M4X12 ZN-B
	35		11011663	SLIDE COVER COIN SLIDE COVER COIN
	36		11011616	COIN CHUTE COIN CHUTE
	37		11011618	БЛОК ДЛЯ КОНВЕЄРА МОНЕТ BLOCCO X CONVOGLIATORE MONETE REGOLABILE

## Model Machine

MACSAE341

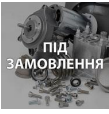
ВЕНДІНГ DIAMANTE RST BLK(10004840 )











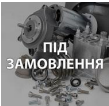















	38		11012131	COIN CONVEYOR ADJUSTABLE FS400/600 COIN CONVEYOR ADJUSTABLE FS400/600
	39		U302.003	МЕТАЛЕВА ГАЙКА M4 UNI 5588 ZNP DADO ESAGONALE M4 UNI 5588 ZNP
	40		U302.002	NUT HEXAGONAL M3 UNI 5588 NUT HEXAGONAL M3 UNI 5588
	41		U116.005	SCREW AUT.PT TCB 3,0X8 WN 1441 VITE AUT.PT TCB 3,0X8 WN 1441 ZNP
	42		U212.006	WASHER 3,2X11X0,5 ZNP WASHER 3,2X11X0,5 ZNP
	43		9111.397	SPRING FOR TRAY /LEVER COIN RECOVERE MOLLA X BACINELLA/LEVA RECUP
	44	 ПІД ЗАМОВЛЕННЯ	129825002	TCB SCREW M4X20 UNI 7687 ZNP TCB SCREW M4X20 UNI 7687 ZNP
	45		123453102	GALV.SELF LOCK NUT HIGH M4 DIN982 GALV.SELF LOCK NUT HIGH M4 DIN 982
	46	 ПІД ЗАМОВЛЕННЯ	U201.005	PLAIN WASHER 4,3X12 DIN 7349 GAL PLAIN WASHER 4,3X12 DIN 7349 GAL
	47		11011619	SUPPORT LEVER COIN RECOVERY SUPPORT LEVER COIN RECOVERY
	48		11011660	LEVER COIN RECOVERY LEVER COIN RECOVERY
	49		11011615	LEVER ASS. COIN RECOVERY LEVER ASS. COIN RECOVERY
	50	 ПІД ЗАМОВЛЕННЯ	11032968	ASSEMBLY COIN BOX ASSEMBLY COIN BOX
	51		11011662	ADJUSTABLE PLATE ADJUSTABLE PLATE

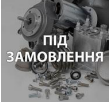

## Model Machine

MACSAE341

















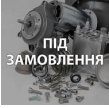





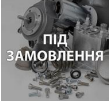

ВЕНДІНГ DIAMANTE RST BLK(10004840 )

	52		11032793	DUCT COIN RECOVERY FS4N <i>CONDOTTO RECUPERO MONETE FS4N</i>
	53		U324.004	NUT M6 FLANGED INDENTED BASE <i>DADO M6 FLANGIATO BASE DENTELLATA</i>
	54		11033002	COIN RECOVER BRACKET FS4N <i>COIN RECOVER BRACKET FS4N</i>
	55		U110.003	SCREW AUT.TCB 3,5X9,5 DIN 7981F <i>VITE AUT.TCB 3,5X9,5 DIN 798</i>
	56		U110.004	SCREW AUT.TCB 3,5X6,5 DIN 7981F <i>VITE AUT.TCB 3,5X6,5 DIN 7981 F NIK</i>
	57		11033723	COIN BOX BRACKET FS4N <i>PIASTRA PROTEZIONE GETTONIERA FS4N</i>
	58		11033000	COIN BOX BRACKET FS4N <i>PIASTRA SUPP.CASSA MONETE FS4N</i>
	59		11032996	BRACKET FOR BANKNOTE READER <i>BRACKET FOR BANKNOTE READER</i>
	60		U127.011	SCREW TAPT.TCB M5,0X8 DIN 7500C <i>SCREW TAPT.TCB M5,0X8 DIN 7500C</i>
	61		11011614	ASS.SCIVOLO MONETE CRISTALLO400 <i>ASS.SCIVOLO MONETE CRISTALLO400</i>
	62		U142.008	PANELVIT TSP 3,5X12 DIN 7505 AGAL <i>PANELVIT TSP 3,5X12 DIN 7505 A GAL</i>
	63		11032985	PLATE COIN RAMP FS4N <i>PLATE COIN RAMP FS4N</i>
	64		U701.003	SNAP RING 7 UNI 7434 <i>ANELLO ELASTICO 7 UNI 7434</i>
	65		129824002	TCB SCREW M4X10 UNI 7687 ZNP <i>VITE TCB M4X10 UNI 7687 ZNP</i>

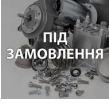
## Model Machine

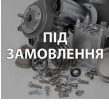
MACSAE341











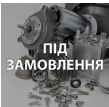















ВЕНДІНГ DIAMANTE RST BLK(10004840 )

	66		11034002	ASSEMBLY DAMPER+GEAR Z.21 <i>ASSEMBLY DAMPER+GEAR Z.21</i>
	67		11033871	SLOW DOWN BRACKET CRS EVO <i>SLOW DOWN BRACKET CRS EVO</i>
	68		11032946	СЕГМЕНТ БАНКНОТОПРИЙМАЧА FS4N <i>BANKNOTE READER CAP FS4N</i>
	69		11032756	РАМКА ДЛЯ ВСТАВЛЯННЯ МОНЕТ ТА ПІД СІРУ КНОПКУ FS4N <i>CORNICE INTRO.MONETE E TASTO GRY FS4N</i>
	70		U005.018	SCREW TE M5,0X16 UNI 5739 ZNP8.8 <i>VITE TE M5,0X16 UNI 5739 ZNP</i>
	71		11032783	КНОПКА ПОВЕРНЕННЯ МОНЕТ FS4N <i>PUSH BUTTON FS4N</i>
	72		9111.355	SPRING FOR CHANGE BUTTON <i>MOLLA X PULSANTE RENDIRESTO</i>
	73		11032782	BANKNOTE READER FRAME FS4N <i>BANKNOTE READER FRAME FS4N</i>
	74		11032785	CHANGE DOOR FS4N <i>SPORTELLLO RENDIRESTO FS4N</i>
	75		11032755	FRAME FOR COIN RECOVERY FS4N <i>FRAME FOR COIN RECOVERY FS4N</i>
	76		11032886	CARD PROTECTION CPU <i>PROTEZIONE SCHEDA CPU</i>
	77		12000962	MULTIGRIP RIVETS 4.8X11 <i>MULTIGRIP RIVETS 4.8X11</i>
	78		11033303	BRACKET TOUCH PANEL <i>BRACKET TOUCH PANEL</i>

## Model Machine

MACSAE341

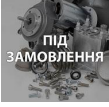

























ВЕНДІНГ DIAMANTE RST BLK(10004840 )

	79	 ПІД ЗАМОВЛЕННЯ	11034579	ROD FOR LOCK <i>ROD FOR LOCK</i>
	80		9111.372.050	DISP. COMPARTM. LOCKING LEVERBLAC <i>LEVA FERMO VANO EROGAZIONE NERO</i>
	81		9111.373	SPRING FOR DISP. COMP. RETAINING <i>MOLLA X FERMO VANO EROGAZ.</i>
	82	 ПІД ЗАМОВЛЕННЯ	U110.011	SCREW AUT.TCB 2,9X9,5 DIN 7981F <i>SCREW AUT.TCB 2,9X9,5 DIN 7981 F</i>
	83	 ПІД ЗАМОВЛЕННЯ	1863.649	REED FOR DOOR <i>REED FOR DOOR</i>
	84	 ПІД ЗАМОВЛЕННЯ	11032791	DISPENSER VAIN SUPPORT FS4N <i>DISPENSER VAIN SUPPORT FS4N</i>
	85	 ПІД ЗАМОВЛЕННЯ	11033004	COIN REVOVER ASSEMBLY <i>ASS.RECUPERO MONETE</i>
	86	 ПІД ЗАМОВЛЕННЯ	11033149	COVER GLASSES FRAME FS6N <i>COVER GLASSES FRAME FS6N</i>
	86	 ПІД ЗАМОВЛЕННЯ	11034084	COVER GLASSES D.83 FRAME CRS EVO <i>COVER GLASSES D.83 FRAME CRS EVO</i>
	87	 ПІД ЗАМОВЛЕННЯ	0894.185	BASKET STOP BRACKET <i>BASKET STOP BRACKET</i>
	88	 ПІД ЗАМОВЛЕННЯ	11007640	SPRING FOR UPPER DOOR MICROSWITCH <i>SPRING FOR UPPER DOOR MICROSWITCH</i>
	89		U207.002	PLAIN WASHER 4,3X9 UNI 6592 GAL <i>ROSETTA PIANA 4,3X9 UNI 6592 ZNP</i>
	90	 ПІД ЗАМОВЛЕННЯ	U043.006	SCREW TCBC M4,0X14 UNI 7687 GALV. <i>SCREW TCBC M4,0X14 UNI 7687 GALV.</i>
	91		1863.033.A20	CUP DISTR. SUPPORT <i>SUPPORTO DISTRIBUTORE BICCH.DX</i>

## Model Machine

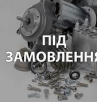
MACSAE341

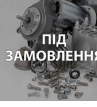













БЕНДІНГ DIAMANTE RST BLK(10004840 )

	92		1863.032.A20	CUP DISTR. SUPPORT <i>SUPPORTO DISTRIBUTORE BICCH.SX</i>
	93		U302.006	NUT HEXAGONAL M10 UNI 5588 <i>DADO ESAGONALE M10 UNI 5</i>
	94		U208.008	TOOTHED WASHER 10,5X18 UNI 3703 G <i>ROSETTA DENT. 10,5X18 UNI 3</i>
	95		11034580	LEVER LOCK <i>LEVER LOCK</i>
	96		U207.001	PLAIN WASHER 5,3X10 UNI 6592 GAL <i>ROSETTA PIANA 5,3X10 UNI 6</i>
	97		U043.015	SCREW TCBC M5,0X12 UNI 7687 GALV. <i>SCREW TCBC M5,0X12 UNI 7687 GALV.</i>
	98		11003448	MOVABLE PLATE FOR FS400 DOOR <i>MOVABLE PLATE FOR FS400 DOOR</i>
	99		11008644	LOCK PIN <i>LOCK PIN</i>
	10001		U046.001	SCREW TEFZ M5,0X16 UNI 6921 GALV. <i>SCREW TEFZ M5,0X16 UNI 6921 GALV.</i>
	1010		11000390	OUTDISTANCE FOR FS400 DOOR <i>OUTDISTANCE FOR FS400 DOOR</i>
	1020		11033154	ASSEMBLY FRONT DOOR FS6N <i>ASS.PORTA ANTERIORE RIVETTATA FS6N</i>
	1030		11032805	PIN HINGE FS4N <i>PERNO CERNIERA FS4N</i>
	1040		11033875	LOWER DOOR CRS EVO BLK <i>CERNIERA PORTA CRS EVO BLK</i>
	1050		U044.002	SCREW TSPC M4,0X10 UNI 7688 GALV. <i>SCREW TSPC M4,0X10 UNI 7688 GALV.</i>

## Model Machine

MACSAE341

ВЕНДІНГ DIAMANTE RST BLK(10004840 )

	1060	 ПІД ЗАМОВЛЕННЯ	11032998	BRACKET FOR LOCK <i>PIASTRA SUPP.SERRATURA FS4N</i>
	1070		NV02.243	KEY RIELDA AJ306A <i>KEY RIELDA AJ306A</i>
	1080		NV02.229	LOCK RIELDA MOD.512 + KEY <i>LOCK RIELDA MOD.512 + KEY</i>
	1090	 ПІД ЗАМОВЛЕННЯ	11033747	CUP STATION'S DOOR <i>CUP STATION'S DOOR</i>
	1100		9991.093	MAGNET D=9,5 X H=1,5 <i>MAGNETE D.9,5 X 1,5</i>
	1110	 ПІД ЗАМОВЛЕННЯ	11014166	LOCK BUSH <i>LOCK BUSH</i>
	1120		11027722	CUP SUPPORT D.83 <i>CUP SUPPORT D.83</i>

# Model Machine

MACSAE341

ВЕЃДИЃ DIAMANTE RST BLK(10004840 )

MACSAE341.T.0004

TAVOLA NR. 4 - ARTICOLO VEЃДИЃ DIAMANTE RST BLK( 10004840 )

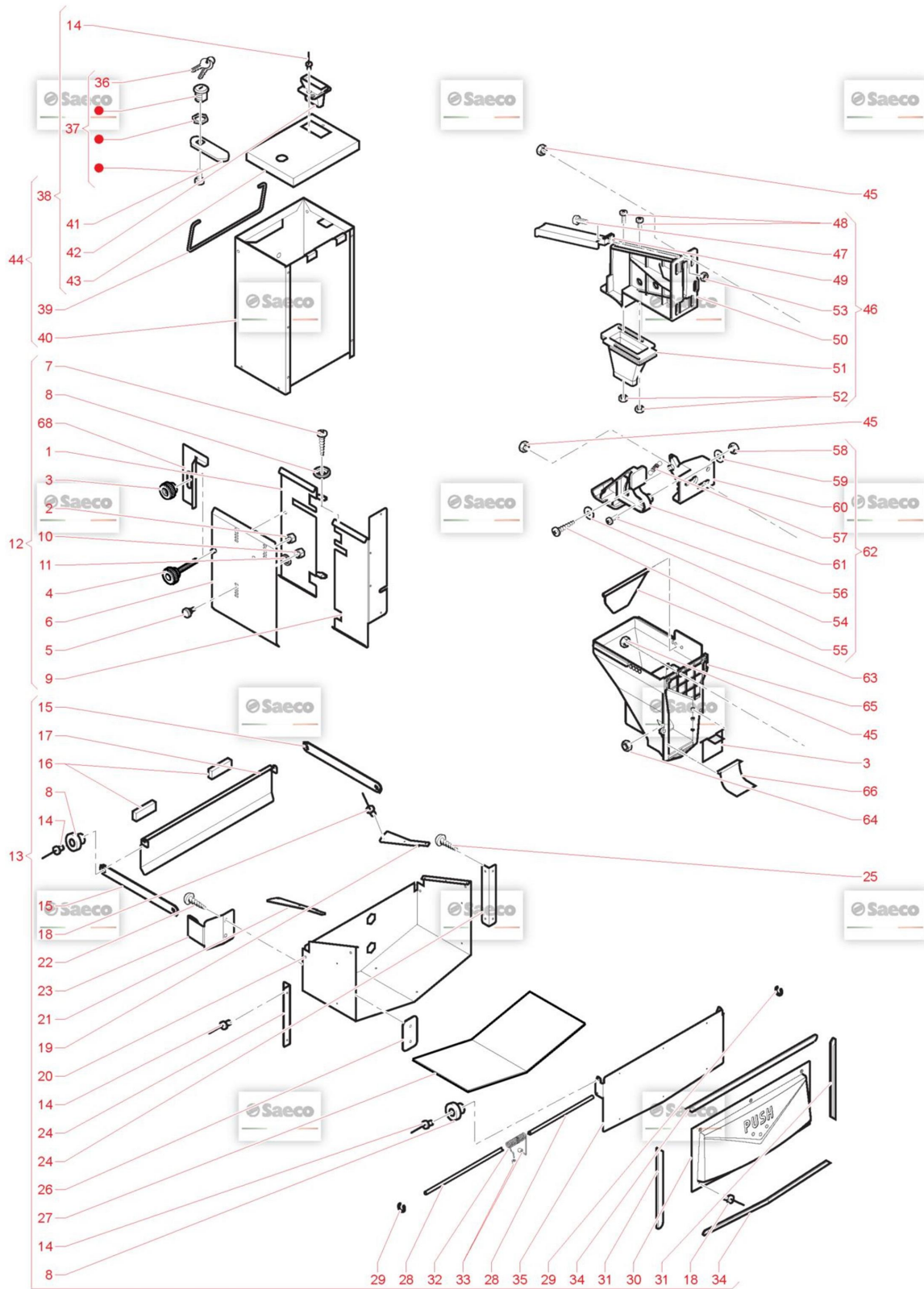

## Model Machine

MACSAE341

БЕНДІНГ DIAMANTE RST BLK(10004840 )

Web Pos. Foto Item - Replace by Description



Press - CTRL + CLICK go to item in a new window

Натисніть - Ctrl + права кнопка миші щоб відкрити запчастину в новому вікні



2

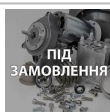

11033143

LEFT OUTLINE SIDE FS6N  
PROFILO LATERALE SX ALLUMINIO FS6N



2



11034111

PROFILE SIDE LX CRS600 EVO SILVER  
PROFILE SIDE LX CRS600 EVO SILVER



3



12002034

KNOB WITH BUSH M5  
KNOB WITH BUSH M5



4

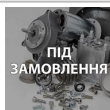

U110.003

SCREW AUT.TCB 3,5X9,5 DIN 7981F  
VITE AUT.TCB 3,5X9,5 DIN 798



5



11032978

LEFT TRACK FOR LEXAN FS4N  
LEFT TRACK FOR LEXAN FS4N



6

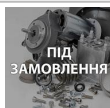

11032976

RIGHT TRACK FOR LEXAN FS4N  
RIGHT TRACK FOR LEXAN FS4N



7

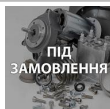

11033142

RIGHT OUTLINE SIDE FS6N  
PROFILO LATERALE DX ALLUMINIO FS6N



7

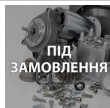

11034109

PROFILE SIDE RX CRS600 EVO  
PROFILE SIDE RX CRS600 EVO



8

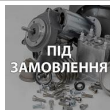

11032788

UPPER/LOWER OUTLINE FSN4  
UPPER/LOWER OUTLINE FSN4



9



11033818

UPPER LEXAN CRS400 EVO  
LEXAN SUPERIORE OPALINO CRS400 EVO



9

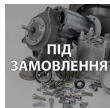

11033819

UPPER LEXAN CRS600 EVO  
UPPER LEXAN CRS600 EVO



10



11033140

ВЕРХНЯ КАРТИНКИ CRISTALLO600 EVO  
UPPER IMAGE CRISTALLO600 EVO



10













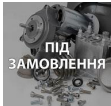

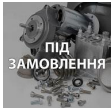

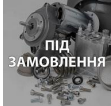



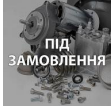

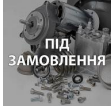

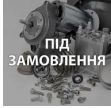

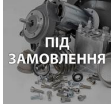

11033371

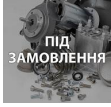
UPPER ADVERTISING CRISTALLO600EVO CAPS  
UPPER ADVERTISING CRISTALLO600EVO CAPS

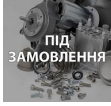
## Model Machine

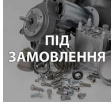
MACSAE341

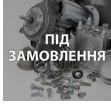
БЕНДІНГ DIAMANTE RST BLK(10004840 )

















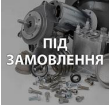





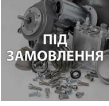

	10		<b>11034502</b>	UPPER IMAGE CRS400 EVO WHITE <i>UPPER IMAGE CRS400 EVO WHITE</i>
	10		<b>11034507</b>	UPPER IMAGE CRS600 EVO CAPS COVIM <i>UPPER IMAGE CRS600 EVO CAPS COVIM</i>
	10		<b>20007552</b>	LEXAN UPPER CRS 600 EVO PROXIPAUSE <i>LEXAN UPPER CRS 600 EVO PROXIPAUSE</i>
	11		<b>11032795</b>	ПЕРЕДНЯ ПАНЕЛЬ ПРОЗОРА FS4N <i>LEXAN SUPERIORE FS4N</i>
	12		<b>11032787</b>	CENTRAL OUTLINE FS4N <i>CENTRAL OUTLINE FS4N</i>
	13		<b>11032797</b>	LEFT SIDE LEXAN FS4N <i>LEXAN LATERALE SX FS4N</i>
	14		<b>11033817</b>	LOWER LEXAN CRS EVO <i>LOWER LEXAN CRS EVO</i>
	15		<b>11033369</b>	LOWER ADVERTISING PLATE CRISTALLO EVO <i>TARGA INFERIORE CRISTALLO EVO CAPS</i>
	15		<b>11033784</b>	LOWER IMAGE CRS H.342 <i>LOWER IMAGE CRS H.342</i>
	15		<b>11034329</b>	LOWER IMAGE CRS EVO CAPS COVIMITA <i>LOWER IMAGE CRS EVO CAPS COVIM ITA</i>
	15		<b>11034335</b>	LOWER IMAGE CRS EVO CAPS CAFFITALY <i>LOWER IMAGE CRS EVO CAPS CAFFITALY</i>
	15		<b>11034503</b>	LOWER IMAGE CRS EVO WHITE <i>LOWER IMAGE CRS EVO WHITE</i>
	15		<b>11034506</b>	LOWER IMAGE CRS EVO CAPS COVIMFRA <i>LOWER IMAGE CRS EVO CAPS COVIMFRA</i>
	15		<b>20007550</b>	LEXAN LOWER CRS EVO PROXI PAUSE <i>LEXAN LOWER CRS EVO PROXI PAUSE</i>

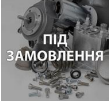

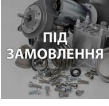
## Model Machine

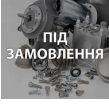
MACSAE341











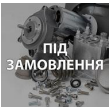

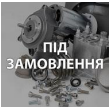

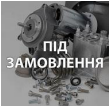











БЕНДІНГ DIAMANTE RST BLK(10004840 )

	16		<b>11032796</b>	LOWER LEXAN CRS EVO <i>LEXAN INFERIORE CRS EVO</i>
	17		<b>11033293</b>	STICKY FILLET 291,1 X 9,5 X 0,8 <i>STICKY FILLET 291,1 X 9,5 X 0,8</i>
	18		<b>11033295</b>	STICKY FILLET 506,8 X 9,5 X 0,8 <i>STICKY FILLET 506,8 X 9,5 X 0,8</i>
	19		<b>11033294</b>	STICKY FILLET 354,3 X 9,5 X 0,8 <i>STICKY FILLET 354,3 X 9,5 X 0,8</i>
	20		<b>11032790</b>	DISPENSER FRAME VAIN FS4N <i>CORNICE VANO EROGAZIONE FS4N</i>
	21		<b>11033810</b>	RIGHT SIDE LEXAN CRS400 EVO <i>LEXAN LATERALE DX CRS400 EVO</i>
	22		<b>15004381</b>	ТАБЛИЧКА З НАЗВАМИ НАПОЇВ ІТА <i>FOGLIO ETICH.PROD.TAST.CAPACITIVA ITA</i>
	22		<b>15004382</b>	PRODUCTS LABEL'S SHEET CRISTALLO EVO ENG <i>PRODUCTS LABEL'S SHEET CRISTALLO EVO ENG</i>
	22		<b>15004383</b>	PRODUCTS LABEL'S SHEET CRISTALLO EVO FRA <i>PRODUCTS LABEL'S SHEET CRISTALLO EVO FRA</i>
	22		<b>15004384</b>	PRODUCTS LABEL'S SHEET CRISTALLO EVO DE <i>PRODUCTS LABEL'S SHEET CRISTALLO EVO DE</i>
	22		<b>15004385</b>	PRODUCTS LABEL'S SHEET CRISTALLO EVO SPA <i>PRODUCTS LABEL'S SHEET CRISTALLO EVO SPA</i>
	22		<b>15004386</b>	PRODUCTS LABEL'S SHEET CRISTALLO EVO POR <i>FOGLIO ETICH.PROD.TAST.CAPACITIVA POR</i>
	22		<b>15004387</b>	PRODUCTS LABEL'S SHEET CRISTALLO EVO NL <i>PRODUCTS LABEL'S SHEET CRISTALLO EVO NL</i>

## Model Machine

MACSAE341

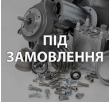
БЕНДІНГ DIAMANTE RST BLK(10004840 )

	22		<b>15004540</b>	PRODUCTS LABEL'S SHEET CRS EVOITA <i>PRODUCTS LABEL'S SHEET CRS EVOITA</i>
	22		<b>15004611</b>	PRODUCTS LABEL'S SHEET CRS EVOCOVIM FRA <i>PRODUCTS LABEL'S SHEET CRS EVO COVIM FRA</i>
	22		<b>15004612</b>	PRODUCTS LABEL'S SHEET CRS EVOCOVIM SPA <i>PRODUCTS LABEL'S SHEET CRS EVOCOVIM SPA</i>
	22		<b>15004613</b>	PRODUCTS LABEL'S SHEET CRS EVOCOVIM POR <i>PRODUCTS LABEL'S SHEET CRS EVOCOVIM POR</i>
	22		<b>15004670</b>	ADD.LABEL'S SHEET CAPACITIVE KEYBOARD <i>ADD.LABEL'S SHEET CAPACITIVE KEYBOARD</i>
	22		<b>21002400</b>	PRODUCTS LABEL'S SHEET CRS EVOPP FRA <i>PRODUCTS LABEL'S SHEET CRS EVOPP FRA</i>
	23		<b>15004037</b>	INSTRUCTION LABEL CRISTALLO C.B ITA <i>INSTRUCTION LABEL CRISTALLO C.B ITA</i>
	23		<b>15004038</b>	INSTRUCTION LABEL CRISTALLO C.B FRA <i>INSTRUCTION LABEL CRISTALLO C.B FRA</i>
	23		<b>15004039</b>	INSTRUCTION LABEL CRISTALLO C.B DE <i>INSTRUCTION LABEL CRISTALLO C.B DE</i>
	23		<b>15004040</b>	INSTRUCTION LABEL CRISTALLO C.B POR <i>INSTRUCTION LABEL CRISTALLO C.B POR</i>
	23		<b>15004041</b>	INSTRUCTION LABEL CRISTALLO C.B ESP <i>INSTRUCTION LABEL CRISTALLO C.B ESP</i>
	23		<b>15004042</b>	INSTRUCTION LABEL CRISTALLO C.B NL <i>INSTRUCTION LABEL CRISTALLO C.B NL</i>
	23		<b>15004043</b>	INSTRUCTION LABEL CRISTALLO C.B ENG <i>INSTRUCTION LABEL CRISTALLO C.B ENG</i>
	24		<b>0775.989</b>	PRICE LABELS WHITE EURO <i>PRICE LABELS WHITE EURO</i>

## Model Machine

MACSAE341

БЕНДІНГ DIAMANTE RST BLK(10004840 )

	25		<b>11032874</b>	CAPACITIVE INTERFACE <i>CAPACITIVE INTERFACE</i>
	26		<b>11032866</b>	UPPER ANGULAR FRAME <i>UPPER ANGULAR FRAME</i>
	27		<b>11032862</b>	LEFT ANGULAR FRAME <i>LEFT ANGULAR FRAME</i>
	28		<b>12002160</b>	SCREW TMTPH2 3,5X9,5 F ZNP ISO4759/1 <i>SCREW TMTPH2 3,5X9,5 F ZNP ISO4759/1</i>
	29		<b>11032867</b>	CAPACITIVE KEYBOARD <i>CAPACITIVE KEYBOARD</i>
	30		<b>11032789</b>	INTERFACE FRAME FS4N <i>INTERFACE FRAME FS4N</i>
	31		<b>11032861</b>	RIGHT ANGULAR FRAME <i>RIGHT ANGULAR FRAME</i>
	32		<b>11032863</b>	LOWER ANGULAR FRAME <i>LOWER ANGULAR FRAME</i>
	33		<b>11031810</b>	400MM LED BOARD <i>400 MM LED BOARD</i>
	34		<b>U110.011</b>	SCREW AUT.TCB 2,9X9,5 DIN 7981F <i>SCREW AUT.TCB 2,9X9,5 DIN 7981 F</i>
	35		<b>15002044</b>	LABEL TWIN TASTE TECH GREY <i>LABEL TWIN TASTE TECH GREY</i>

# Model Machine

MACSAE341

ВЕНДІНГ DIAMANTE RST BLK(10004840 )

MACSAE341.T.0005



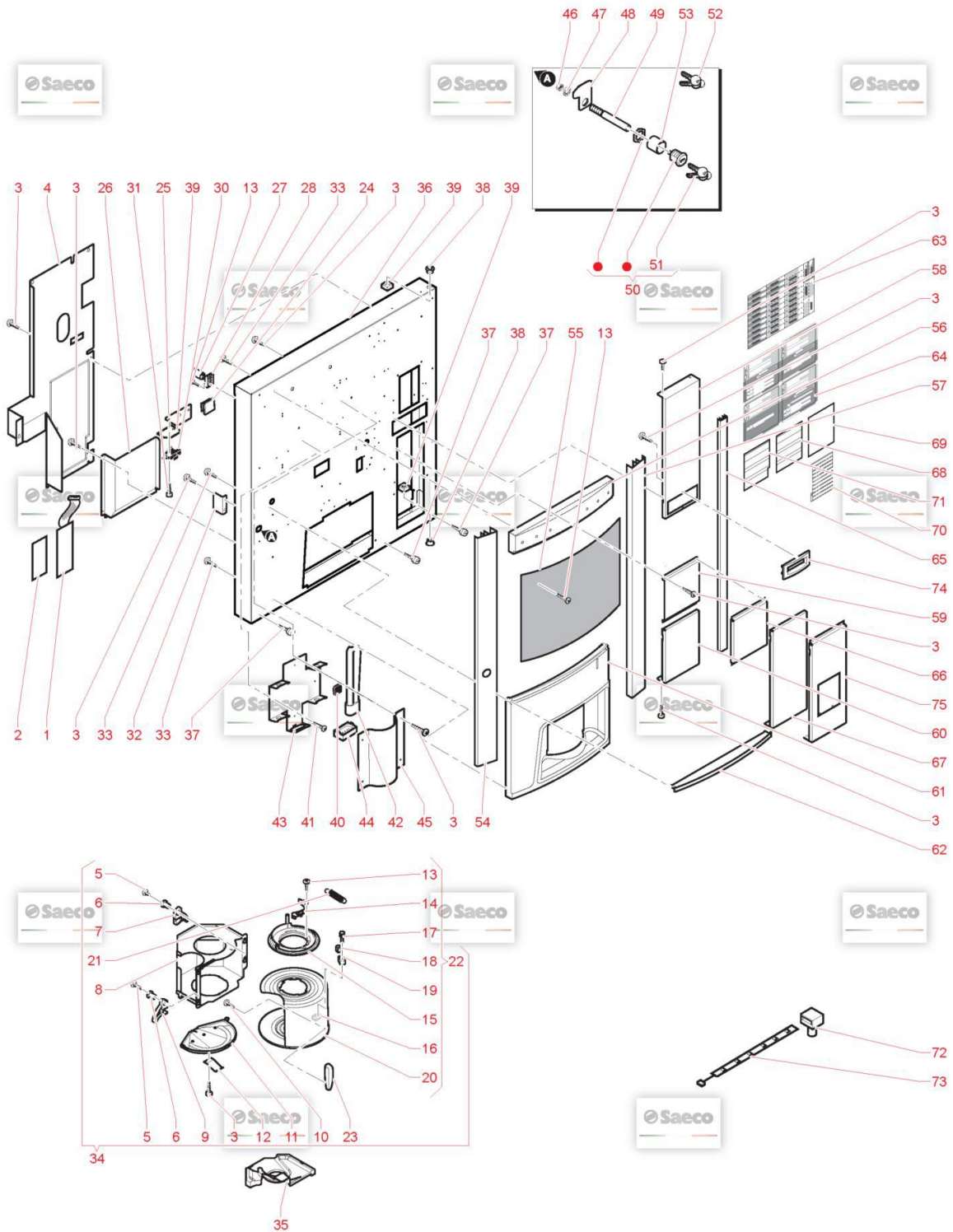























TAVOLA NR. 5 - ARTICOLO ВЕНДІНГ DIAMANTE RST BLK( 10004840 )

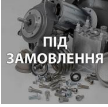

## Model Machine

MACSAE341











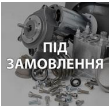















ВЕНДІНГ DIAMANTE RST BLK(10004840 )

Web	Pos.	Foto	Item - Replace by	Description
				<i>Press - CTRL + CLICK go to item in a new window Натисніть - Ctrl + права кнопка миші щоб відкрити запчастину в новому вікні</i>
	1		11025295	TEFLON TUBE 3X6 L.170 1/8"-1/8 TEFLON TUBE 3X6 L.170 1/8-1/8
	2	 ПІД ЗАМОВЛЕННЯ	9972.246	СИЛІКОНОВА ТРУБКА 5X10 SAECO 265918 (2 МЕТРИ) TUBO SILICONE 5X10 L.2000 MM
	3		11032038	FILTER INTAKE IN LUNG WATER SUPPLY FILTRO POLMONE IN ASPIRAZ.RETE IDRICA
	4		9972.055	ТРУБКА СИЛІКОНОВА 8X12 2 МЕТРИ SILICONE TUBE 8X12 L.2000MM
	5		NV99.004	CONNECTOR T MORONI 8026047 D=8 CONNECTOR T MORONI 8026047 D=8
	6		149185850	ТРИМАЧ (ГУМОВИЙ)ПОМПИ ДЛЯ КАВОМАШИН SAECO MAGIC 4002012 (...) SUPPORTO POMPA EATON MAGIC 4
	7		9972.057	КОРИЧНЕВА ГУМОВА ТРУБКА 5X8 2 МЕТРИ TUBO SILICONE MARRON 5X8 L.2000 MM
	8		NV99.099	TURBINE D=1,2 ASSY. TURBINA DIGMESA FHKSC 1,2 ARNITE OC
	9	 ПІД ЗАМОВЛЕННЯ	144320200	SELF LOCK STRIP W=2.6 L=200 SELF LOCK STRIP W=2.6 L=200
	10		11005590	SAFETY VALVE/NON RETURN ASS. NEW ASS.VALVOLA SICUREZZA/NON RI
	11		11032615	FITTING ADAPTER VALVE FITTING ADAPTER VALVE
	12		20007360	ОБХІДНИЙ КЛАПАН FLUID-O-TECH B7E BYPASS VALVE FLUID-O-TECH B7E
	13	 ПІД ЗАМОВЛЕННЯ	9070.034.00A	POMPE ULKA EP7 POMPA ULKA EP7 230V

## Model Machine

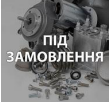
MACSAE341















ВЕНДІНГ DIAMANTE RST BLK(10004840 )

	13		<b>9070.034.00F</b>	ULKA PUMP EP7 120V <i>ULKA PUMP EP7 120V</i>
	13		<b>9070.042.00A</b>	ULKA НАСОС (ПОМПА) EX5GW 230/240V 50HZ SD1 БЪЯНКО 15 BAR <i>ULKA PUMP EX5 SD1</i>
	14		<b>11033578</b>	ASSMEBLY PUMP EX5 SD1 230V <i>ASSMEBLY PUMP EX5 SD1 230V</i>
	15		<b>11024178</b>	WATER FILTER PHEDRA <i>WATER FILTER PHEDRA</i>
	16		<b>147920150</b>	90° INLET PUMP CONNECTOR <i>RACCORDO A 90° IN SANTOPRENE</i>
	17		<b>147920800</b>	Y CONNECTOR D=8 ART.80.26.048KA.466 <i>RACCORDO Y D=8 ART.80.26.048 KA.466</i>
	18		<b>11025292</b>	TEFLON TUBE 3X6 L.230 1/8"-1/8 <i>TEFLON TUBE 3X6 L.230 1/8"-1/8</i>
	18		<b>11025297</b>	TEFLON TUBE 3X6 L.310 1/8"-1/8 <i>TEFLON TUBE 3X6 L.310 1/8"-1/8</i>
	19		<b>140321961</b>	ПРОКЛАДКА O-RING ДЛЯ КАВОМАШИНИ SAECO 2031 TERMOIL <i>OR 2031 IN TERMOIL</i>
	20		<b>9071.098</b>	REINFORCEMENT FOR ULKA PUMP <i>REINFORCEMENT FOR ULKA PUMP</i>
	21		<b>NV99.077</b>	ЗАЖИМНА СТЯЖКА D=9,8/10,6 1 .6 PHILIPS SAECO 996530069882 <i>FASCETTA STRINGITUBO D=9,8/10,6</i>
	22		<b>11012024</b>	ULKA PUMP ASS. EP7 120/60 CR600TTT UL <i>ULKA PUMP ASS. EP7 120/60 CR600TTT UL</i>
	22		<b>11012179</b>	ULKA PUMP ASS. EP7 230/50 CR600TTT <i>ULKA PUMP ASS. EP7 230/50 CR600TTT</i>
	22		<b>9070.043.00A</b>	ULKA PUMP+NON RETURN <i>ULKA PUMP EX5 SD1 +NON RETURN</i>

## Model Machine

MACSAE341

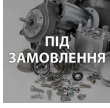
ВЕНДІНГ DIAMANTE RST BLK(10004840 )

	23		NV03.006	CAP KAPSTO LPN 615/010 TAPPO KAPSTO LPN 615/010
	24		9161.262.060	DRIP CHANNEL COVER COPERTURA CANALINO RACCOGLIGOCCE
	25		9111.597.050	COFFEE DISCHARGE CHANNEL SHORT CANALINO SCARICO CAFFE' CORTO
	26		NV99.072	HOSE CLAMP D. 11.6/12.3 HOSE CLAMP D. 11.6/12.3
	27		144650300	ФІЛЬТР ОЧИСТКИ ВОДИ ДЛЯ КАВОМАШИНИ SAECO NEW (NV99.001) (88... ASPIRATION FILTER GAUZE NET 500 (NEW)
	28		NV99.050	HOSECLAMP D. 13.3/14.1 HOSECLAMP D. 13.3/14.1
	28		NV99.087	BAND D=11/11,6 BAND D=11/11,6
	29		9111.141	DISCHARGE TUBE CLOSURE SPRING DISCHARGE TUBE CLOSURE SPRING

# Model Machine

MACSAE341

ВЕНДИНГ DIAMANTE RST BLK(10004840 )

MACSAE341.T.0006

TAVOLA NR. 6 - ARTICOLO ВЕНДИНГ DIAMANTE RST BLK( 10004840 )

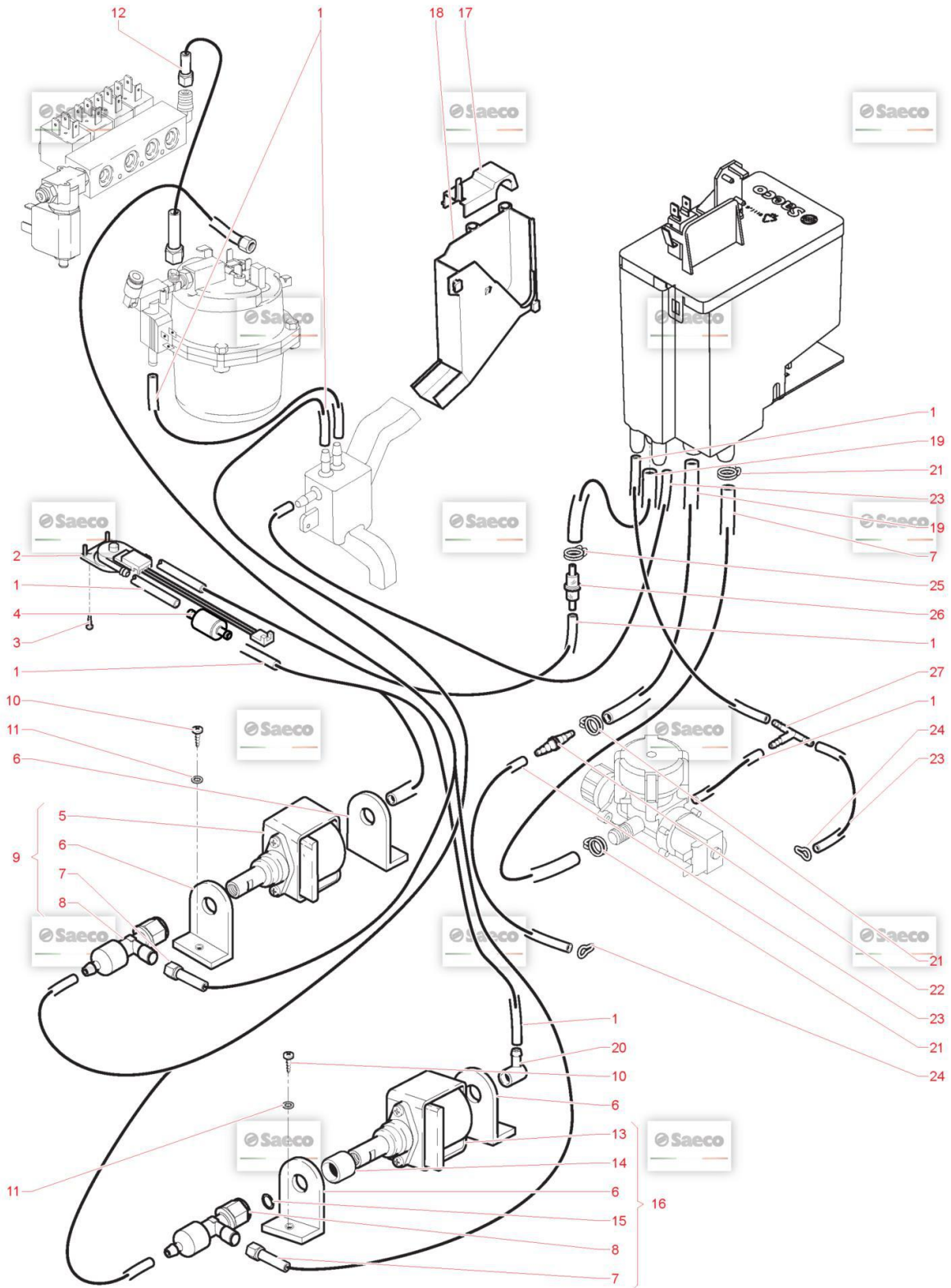





























## Model Machine

MACSAE341

























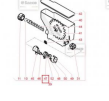

ВЕНДІНГ DIAMANTE RST BLK(10004840 )

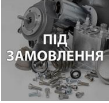
Web	Pos.	Foto	Item - Replace by	Description
				<i>Press - CTRL + CLICK go to item in a new window Натисніть - Ctrl + права кнопка миші щоб відкрити запчастину в новому вікні</i>
	1		11001578	COVER CONTAINER SINGLE SOLUBLE COPERCHIO CONTENITORE SOLUBILE SINGOLO
	2		11001577	EXTENSION CONTAINER SINGLE SOLUBLE PROLUNGA CONTENITORE SOLUBILE SINGOLO
	3		11001576	BASE CONTAINER SINGLE SOLUBLE BASE CONTENITORE SOLUBILE SINGOLO
	4		11001658	SCROLL SCREW COCLEA PER DEVIATORE
	5		NM03.013	OR 2,3X15 NBR OR 2,3X15 NBR
	6		11012130	BACK BUSH REINFORCE BACK BUSH REINFORCE
	7		NM03.022	OR ORM 0060-10 NBR OR ORM 0060-10 NBR
	8		U701.003	SNAP RING 7 UNI 7434 ANELLO ELASTICO 7 UNI 7434
	9		11001580	PIN WHEEL CONTAINER SINGLE SOLUBLE PERNO RUOTA DENTATA CONT.SOLUB.SINGOLO
	10		11032945	SPACE FOR GEAR BPA FREE SPACE FOR GEAR BPA FREE
	11		9111.702	WHEEL DOUBLE CONTAINER RUOTA CONTENITORE DOPPIO
	12		11001654	BUSH CONTAINER BOCCOLA CONTENITORE
	13		9111.425.060	POWDER DUCT CONDOTTO POLVERE ORIENTABILE

## Model Machine

MACSAE341



















ВЕНДІНГ DIAMANTE RST BLK(10004840 )

	14		9111.457.060	BUSH FOR LEFT/RIGHT DUCT COSMEC <i>BOCCOLA X CONDOTTO DX-SX COSMEC</i>
	15		9111.428.060	PLUG FOR LEFT-RIGHT DUCT <i>TAPPO X CONDOTTO DX-SX</i>
	16		11004505	ASSEMBLY SINGLE CONTAINER W/SWITCH <i>ASS.MONTATO CONT.SINGOLO C/DEVIATORE</i>
	17		11031883	ASSEMBLY SINGLE CONTAINER <i>ASSEMBLY SINGL CONTAINER</i>
	18		11005180	SCROLL SCREW FOR NEW DISPENSER APERTURE <i>COCLEA X BOCCHETTA EROGAZIONE APERTURE SCROLL SCREW FOR ...</i>
	19		11028378	FRONT BUSH <i>FRONT BUSH</i>
	20		11031678	EASY DRY DISPENSER APERTURE <i>EASY DRY DISPENSER APERTURE</i>
	21		11031679	DISPENSER FAN EASY DRY <i>DISPENSER FAN EASY DRY</i>
	22		11031691	CARTER FOR GEAR EASY DRY <i>CARTER FOR GEAR EASY DRY</i>
	23		11031692	FELT RING DE=47,4 DI=41,4H=4 <i>FELT RING DE=47,4 DI=41,4H=4</i>
	24		11031690	WHEEL Z=18 EASY DRY <i>WHEEL Z=18 EASY DRY</i>
	25		11005182	WHEEL Z=9 <i>WHEEL Z=9</i>
	26		11005168	LID CARTER GEAR <i>LID CARTER GEAR</i>
	27		21001290	KIT NEW POWDER DISPENSING SYSTEM <i>KIT NEW POWDER DISPENSING SYSTEM</i>

## Model Machine

MACSAE341

ВЕНДІНГ DIAMANTE RST BLK(10004840 )

	28		11031886	ASSEMBLY SINGLE CONTAINER <i>ASSEMBLY SINGLE CONTAINER</i>
	29		11006124	WIRE AGITATOR UNIFIED <i>FILO AGITATORE UNIFICATO WIRE AGITATOR UNIFIED</i>
	30		9111.731	SPRING <i>MOLLA AGITATORE</i>
	31		11007155	ПЛАСТИКОВИЙ ТРИМАЧ ВЗБИВАЛКИ SAECO 9111.735 <i>AGITATOR SUPPORT</i>
	32		9121.155	HOOD FOR RATIOMOTOR <i>CUFFIA X MOTORIDUTTORE</i>
	33		9121.106.00P	SUGAR RATIOMOTOR 24V DC <i>MOTORIDUTTORE ZUCCHERO 24V D.C.</i>
	34		9111.131	COUPLING FOR SOLUBLES MOTOR <i>GIUNTO X MOTORE SOLUBILI</i>
	35		U116.003	SCREW AUT.PT TCB 3,0X12 WN 1441 <i>VITE AUT.PT TCB 3,0X12 WN 1441 ZNP</i>
	35		U116.005	SCREW AUT.PT TCB 3,0X8 WN 1441 <i>VITE AUT.PT TCB 3,0X8 WN 1441 ZNP</i>

# Model Machine

MACSAE341

ВЕНДІНГ DIAMANTE RST BLK(10004840 )

MACSAE341.T.0007

TAVOLA NR. 7 - ARTICOLO ВЕНДІНГ DIAMANTE RST BLK( 10004840 )

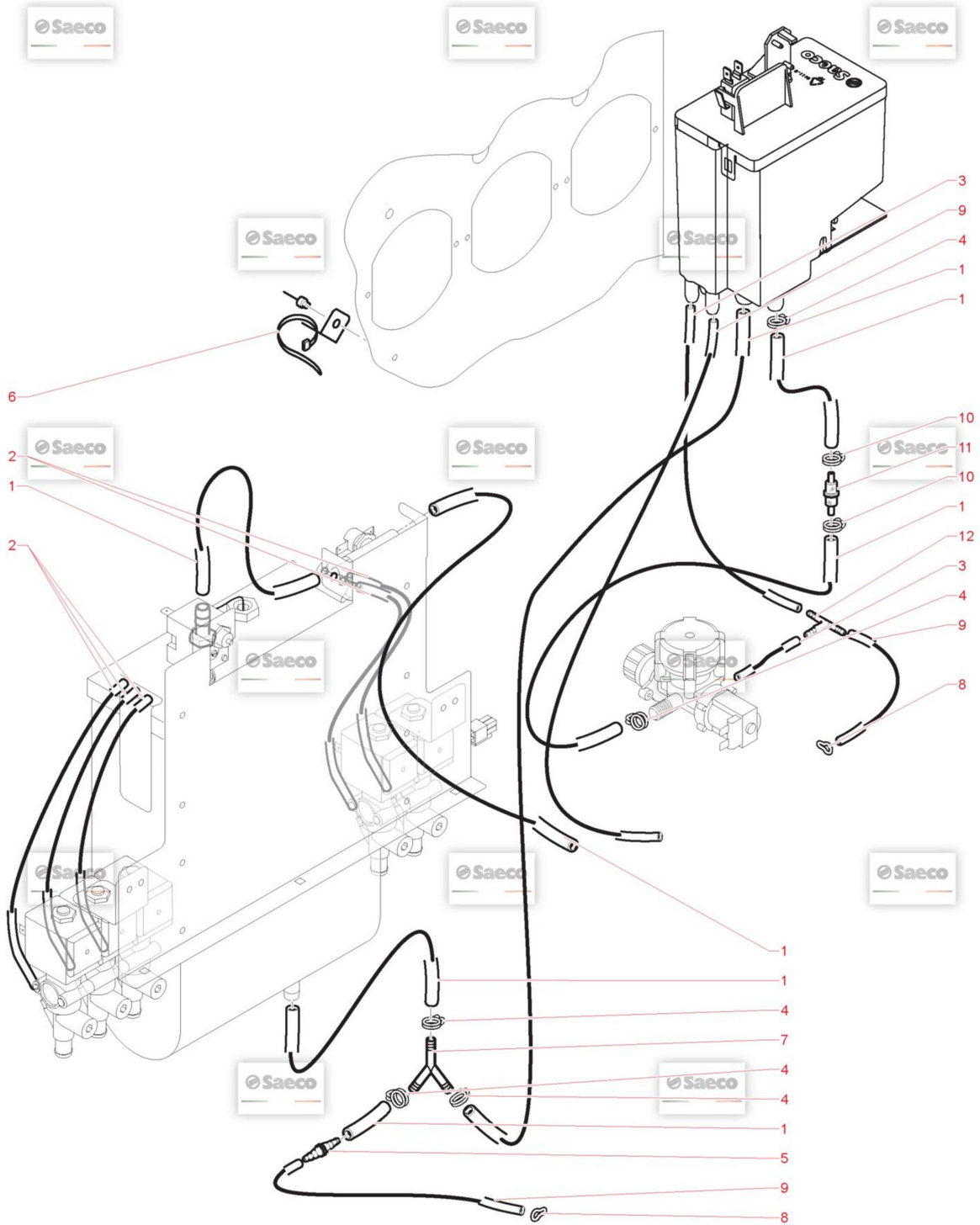

## Model Machine

MACSAE341

ВЕНДІНГ DIAMANTE RST BLK(10004840 )

Web Pos. Foto Item - Replace by Description



*Press - CTRL + CLICK go to item in a new window  
Натисніть - Ctrl + права кнопка миші щоб відкрити запчастину в новому вікні*



1



11001578

COVER CONTAINER SINGLE SOLUBLE  
COPERCHIO CONTENITORE SOLUBILE SINGOLO



2



11001577

EXTENSION CONTAINER SINGLE SOLUBLE  
PROLUNGA CONTENITORE SOLUBILE SINGOLO



3



11001576

BASE CONTAINER SINGLE SOLUBLE  
BASE CONTENITORE SOLUBILE SINGOLO



4



9111.701

SCROLL SCREW DOUBLE CONTAINER  
COCLEA CONTENITORE DOPPIO



5



NM03.013

OR 2,3X15 NBR  
OR 2,3X15 NBR



6



11012130

BACK BUSH REINFORCE  
BACK BUSH REINFORCE



7



NM03.022

OR ORM 0060-10 NBR  
OR ORM 0060-10 NBR



8



U701.003

SNAP RING 7 UNI 7434  
ANELLO ELASTICO 7 UNI 7434



9



9111.702

WHEEL DOUBLE CONTAINER  
RUOTA CONTENITORE DOPPIO



10

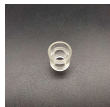

11032945

SPACE FOR GEAR BPA FREE  
SPACE FOR GEAR BPA FREE



11



11001580

PIN WHEEL CONTAINER SINGLE SOLUBLE  
PERNO RUOTA DENTATA CONT.SOLUB.SINGOLO



12



9111.630.060

BUSH FOR POWDERS TANK  
BOCCOLA X SERBAT.POLVERI C/AGGANCI



13























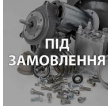

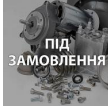

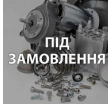

9111.629.060

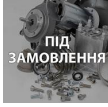
APERTURE FOR SOLUBLES HOPPER  
APERTURE FOR SOLUBLES HOPPER

## Model Machine

MACSAE341

ВЕНДІНГ DIAMANTE RST BLK(10004840 )

	14		9111.338.270	BULKHEAD FOR APERT. CLOSURE ORANGE <i>PARATIA CHIUSURA BOCCHETTA ARANCIO</i>
	15		11026696	ASSEMBLY SINGLE CONTAINER <i>ASS.MONT.CONTENITORE SINGOLO</i>
	16		11006124	WIRE AGITATOR UNIFIED <i>FILO AGITATORE UNIFICATO WIRE AGITATOR UNIFIED</i>
	17		9111.731	SPRING <i>MOLLA AGITATORE</i>
	18		11007155	ПЛАСТИКОВИЙ ТРИМАЧ ВЗБИВАЛКИ SAECO 9111.735 <i>AGITATOR SUPPORT</i>
	19		11006123	ASSEMBLY SINGLE CONTAINER WITHAGITATOR <i>ASS.MONT.CONTENITORE SINGOLO C/AGITATORE</i>
	19		11031640	ASSEMBLY SINGLE CONTAINER WITHAGITATOR <i>ASSEMBLY SINGLE CONTAINER WITH AGITATOR</i>
	20		11032718	ASSEMBLY SINGLE CONTAINER H.350 <i>ASSEMBLY SINGLE CONTAINER H.350</i>
	21		11001658	SCROLL SCREW <i>COCLEA PER DEVIATORE</i>
	22		11032119	ADAPTER FOR EXTENSION CONTAINER SOLUBLE <i>ADAPTER FOR EXTENSION CONTAINER SOLUBLE</i>
	23		11001654	BUSH CONTAINER <i>BOCCOLA CONTENITORE</i>
	24		9111.425.060	POWDER DUCT <i>CONDOTTO POLVERE ORIENTABILE</i>
	25		9111.457.060	BUSH FOR LEFT/RIGHT DUCT COSMEC <i>BOCCOLA X CONDOTTO DX-SX COSMEC</i>
	26		9111.428.060	PLUG FOR LEFT-RIGHT DUCT <i>TAPPO X CONDOTTO DX-SX</i>



# Model Machine

MACSAE341

ВЕНДІНГ DIAMANTE RST BLK(10004840 )

MACSAE341.T.0008

TAVOLA NR. 8 - ARTICOLO ВЕНДІНГ DIAMANTE RST BLK( 10004840 )

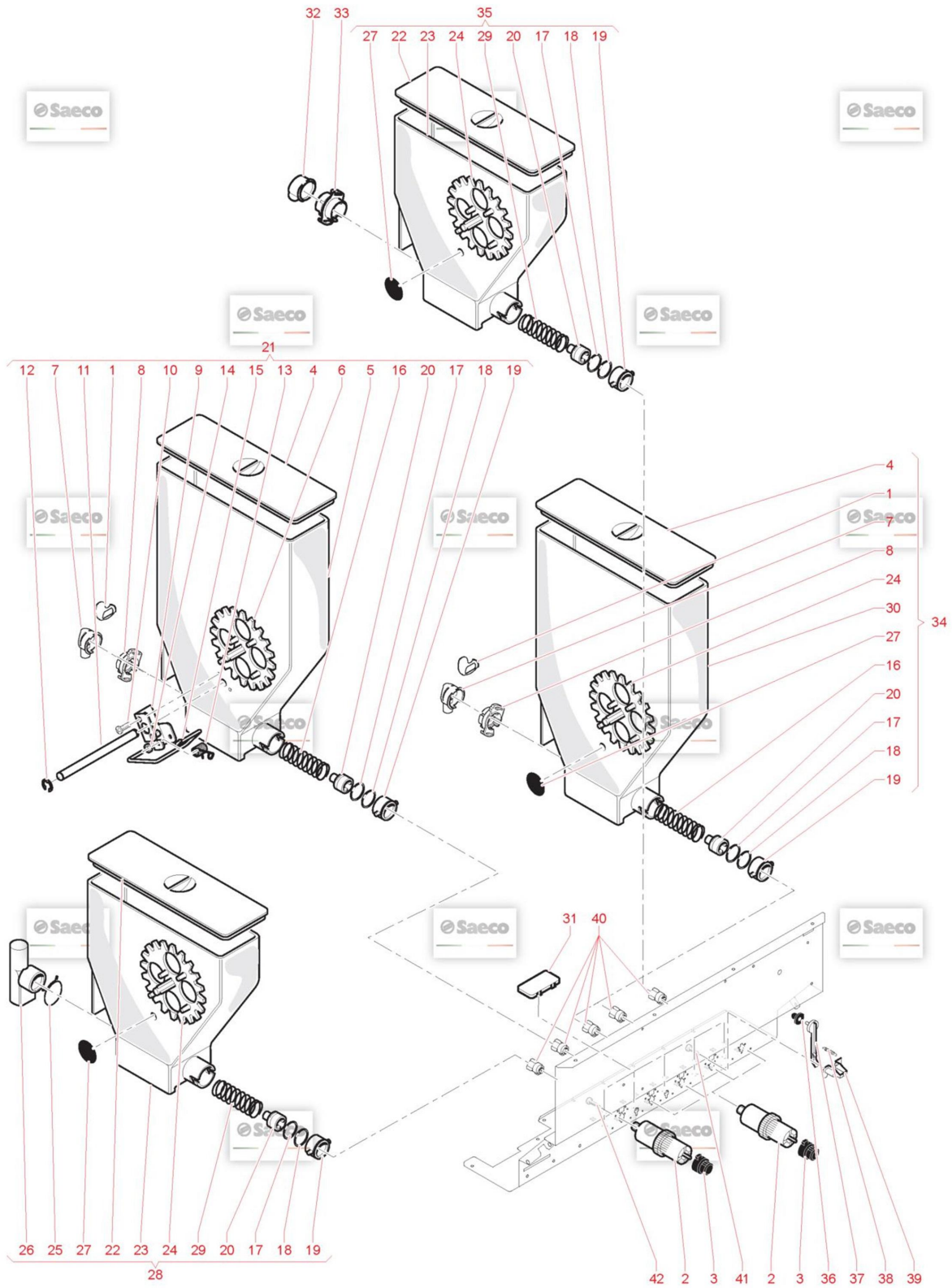



## Model Machine

MACSAE341

ВЕНДІНГ DIAMANTE RST BLK(10004840 )

Web Pos. Foto Item - Replace by Description



Press - CTRL + CLICK go to item in a new window

Натисніть - Ctrl + права кнопка миші щоб відкрити запчастину в новому вікні



1

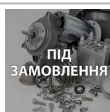

11025292

TEFLON TUBE 3X6 L.230 1/8"-1/8  
TEFLON TUBE 3X6 L.230 1/8"-1/8



1



11025295

TEFLON TUBE 3X6 L.170 1/8"-1/8  
TEFLON TUBE 3X6 L.170 1/8"-1/8



1

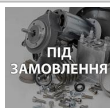

11025297

TEFLON TUBE 3X6 L.310 1/8"-1/8  
TEFLON TUBE 3X6 L.310 1/8"-1/8



1



9979.A27

TEFLON TUBE ASS. 4X6 L.310 1/8"  
TEFLON TUBE ASS. 4X6 L.310 1/8



2



129516803

SCREW TCB3,5X19 DIN 7981 NICK  
SCREW TCB3,5X19 DIN 7981 NICK



2



129824002

TCB SCREW M4X10 UNI 7687 ZNP  
VITE TCB M4X10 UNI 7687 ZNP



2



U109.021

SCREW AUT.TCB 3,5X22 DIN 7981C  
SCREW AUT.TCB 3,5X22 DIN 7981 C



3



20005373

SOLENOID X HS1 11023762  
SOLENOID X OLAB 24V DC 6000BH/BODN



4

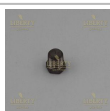

12001169

ЛАТУННА ЗАГЛУШКА BRASS CAP 1/8 GAS CONICAL TEA  
BRASS CAP 1/8 GAS CONICAL TEA



5



11011470

BLOCK 4 ELECTROVALVE DC OLAB TEA  
BLOCK 4 ELECTROVALVE DC OLAB TEA



6



NM01.004

OR 2025 SILICONE  
OR 2025 SILICONE



7



11011453

RUBBER HOLDER CONNECTOR TEA  
RUBBER HOLDER CONNECTOR TEA



8













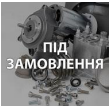















9972.057

КОРИЧНЕВА ГУМОВА ТРУБКА 5X8 2 МЕТРИ  
TUBO SILICONE MARRON 5X8 L.2000 MM

## Model Machine

MACSAE341



























ВЕНДІНГ DIAMANTE RST BLK(10004840 )

	9	 ПІД ЗАМОВЛЕННЯ	9111.405.060	MIXER HOLE CAP BROWN <i>MIXER HOLE CAP BROWN</i>
	10		U116.006	SCREW AUT.PT TCB 3,5X12 WN 1441 ZNP <i>VITE AUT.PT TCB 3,5X12 WN 1441 ZNP</i>
	11		11025082	1/8"G M/CONICAL ORIENT. NUT/OGV <i>1/8G M/CONICAL ORIENT. NUT/OGV</i>
	11		NR10.014	МЕТАЛЕВИЙ ПЕРЕХІДНИК 1/8" D.6 <i>RACCORDO 1/8" D.6 ORIENTABILE COD. OLAB</i>
	12		20005374	ASS.NUCLEO FIS+MOB.X 11009225 <i>ASS.NUCLEUS 6000BH/BODN X 11009225</i>
	13	 ПІД ЗАМОВЛЕННЯ	9111.713	PLATE <i>PIASTRA ELETTROVALVOLE</i>
	14	 ПІД ЗАМОВЛЕННЯ	9972.246	СИЛІКОНОВА ТРУБКА 5X10 SAECO 265918 (2 МЕТРИ) <i>TUBO SILICONE 5X10 L.2000 MM</i>
	15		U116.005	SCREW AUT.PT TCB 3,0X8 WN 1441 <i>VITE AUT.PT TCB 3,0X8 WN 1441 ZNP</i>
	16		U207.004	PLAIN WASHER 4,3X16 UNI 6592 GAL <i>PLAIN WASHER 4,3X16 UNI 6592 GAL</i>
	17		9111.209.060	CURSOR FOR SPIRAL MIXER FIXING <i>CURSOR FOR SPIRAL MIXER FIXING</i>
	18		9111.211	SPRING FOR MIXER CURSOR <i>MOLLA X CURSORE MISCELATORE</i>
	19		9111.643.060	RAPID FIXING MIXER <i>RAPID FIXING MIXER</i>
	20		9111.010.060	LID FOR FUNNEL BROWN <i>COPERCHIO X IMBUTO MARRON</i>
	21		9111.011.060	SEAL FOR FUNNEL BROWN <i>GUARNIZIONE X IMBUTO MARRON</i>

## Model Machine

MACSAE341





















ВЕНДИНГ DIAMANTE RST BLK(10004840 )

	22		9111.009.060	FUNNEL FOR POWDERS BROWN <i>IMBUTO X POLVERI MARRON</i>
	23		1863.A07	ESPRESSO NOZZLE <i>ASS.UGELLO ESPRESSO</i>
	24		9111.771.270	MOTOR COUPLING ORANGE RAL <i>MOTOR COUPLING ORANGE RAL</i>
	25		9121.248.00P	MOTOP MIKCEPA '05 24V DC - M.B.T. COD. 912124800 SAECO 9121.248.00 <i>MOTORE MIXER '05 24V DC - M.B.T.</i>
	26		9111.773.060	MOTOR PROTECTION RING <i>ANELLO PROTEZIONE MOTORE MIXER '05</i>
	27		9972.055	ТРУБКА СИЛІКОНОВА 8X12 2 МЕТРИ <i>SILICONE TUBE 8X12 L.2000MM</i>
	28		NV99.072	HOSE CLAMP D. 11.6/12.3 <i>HOSE CLAMP D. 11.6/12.3</i>
	29		9111.349	ELBOW DISPENSING NOZZLE <i>UGELLO EROGAZIONE GOMITO</i>
	30		9111.769.150	MIXER FLANGE <i>MIXER FLANGE</i>
	31		9111.770.060	COVER MIXER FLANGE <i>COVER MIXER FLANGE</i>
	32		NM03.012	OR ORM 0320-25 NBR <i>OR ORM 0320-25 NBR</i>
	33		9111.772.060	DISK FAN <i>VENTOLINA A DISCO MIXER '05</i>
	34		NM05.015	ПРОКЛАДКА V-RING 405 МІКСЕРА ДЛЯ КАВОМАШИН SAECO <i>V-RING MIXER '05</i>

## Model Machine

MACSAE341

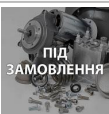
ВЕНДІНГ DIAMANTE RST BLK(10004840 )

	35		9110.160.06P	ДВИГУН МІКСЕРА ДЛЯ КАВОМАШИНИ SAECO 05 24V DC SAECO 9110.1... ASS.MIXER '05 24V DC GROUP 500 SAECO
	36		9111.230.270	MIXER LOCKING RING NUT ORANGERAL GHIERA BLOCCAGGIO MIXER ARANCIO RAL
	37		1863.A10	ASS.MIXER FS400 ASS.MIXER A SPIRALE FS400
	38		9111.227.060	MIXER CASING CORPO MIXER
	39		9110.027.060	MIX CASING ASS. ASS.CORPO MIX SAECO CRISTALLO,ATLANTE,QUARZO,RUBINO
	40		9111.232.060	STD TUBE HOLDER SLEEVE MANICOTTO PORTATUBO STANDARD
	40		9111.233.060	DECAFF.TUBE HOLDER SLEEVE MANICOTTO PORTATUBO DECAFFEINATO
	41		20007305	ЧАСТИНА ЕЛЕКТРОМАГНІТНОГО КЛАПАНА З ПОДВИЖНИМ СЕРДЕЧНИК... SPARE EV MOBILE CORE 11023762
	42		11027286	ELETTROVALVE 24V DC TEA ELETTROVALVE 24V DC TEA
	43	 ПІД ЗАМОВЛЕННЯ	NV99.036	HOSECLAMP D=8,5 09993.41.00 HOSECLAMP D=8,5 09993.41.00
	44		9991.035	NUT 1/8 H 4.5 DADO 1/8 H.4,5

# Model Machine

MACSAE341

ВЕНДІНГ DIAMANTE RST BLK(10004840 )

MACSAE341.T.0009



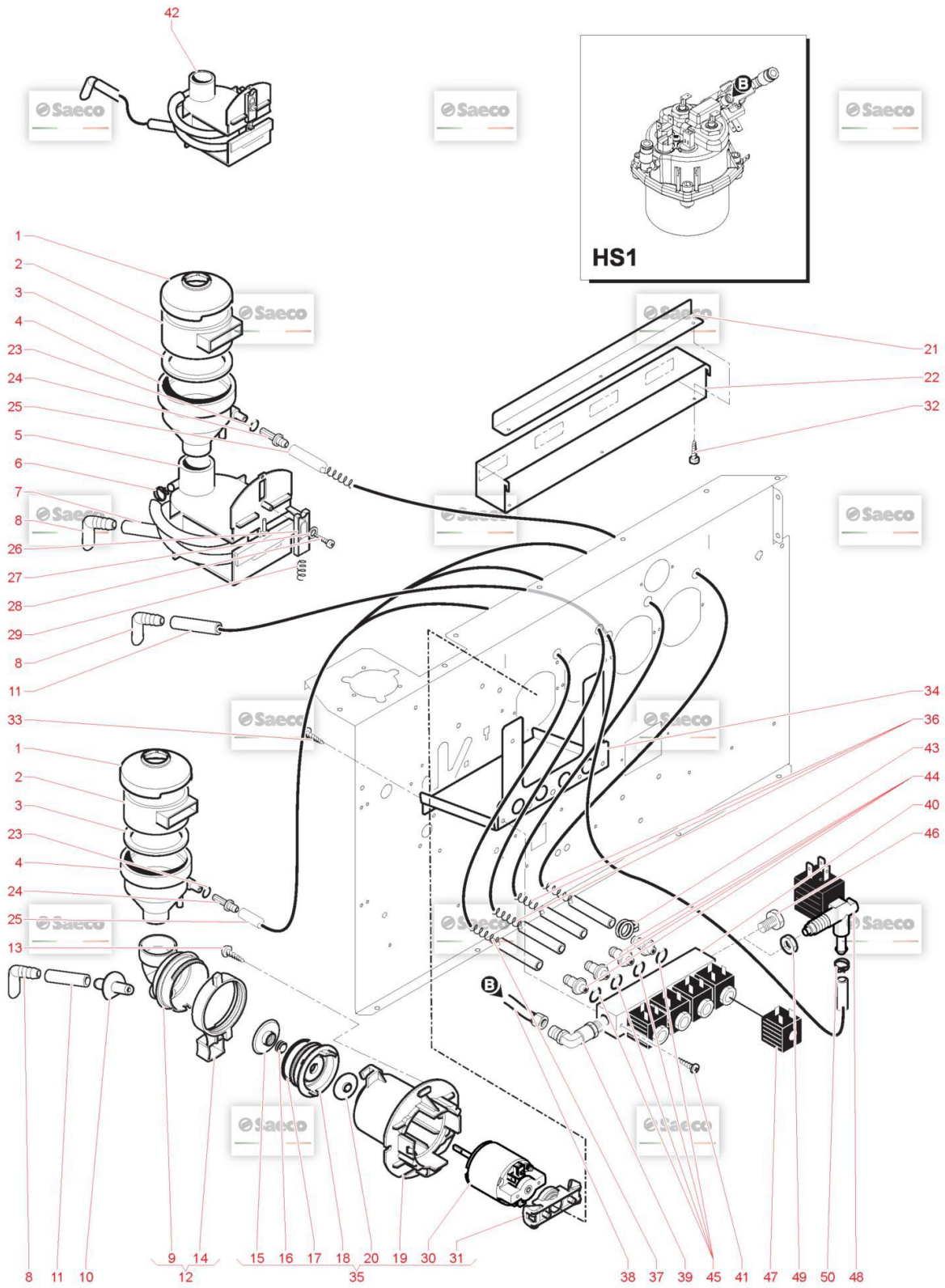









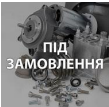













TAVOLA NR. 9 - ARTICOLO ВЕНДІНГ DIAMANTE RST BLK( 10004840 )



## Model Machine

MACSAE341





























БЕНДІНГ DIAMANTE RST BLK(10004840 )

Web	Pos.	Foto	Item - Replace by	Description
				<i>Press - CTRL + CLICK go to item in a new window Натисніть - Ctrl + права кнопка миші щоб відкрити запчастину в новому вікні</i>
	1		11032592	TUBE TEFLON 4X2 L.320 <i>TUBE TEFLON 4X2 L.320</i>
	2		9011.144	SS FORK FOR TUBE D=4 <i>FORCELLA X TUBO D.4</i>
	3		140328059	OR 2015 SILICONE PTFE/FDA <i>OR 2015 SILICONE PTFE/FDA</i>
	4		9181.348	TEA/BRASS CONNECTOR 1/8" CONICAL AT 90° <i>TEA/BRASS CONNECTOR 1/8 CONICAL AT 90°</i>
	5		11032408	ЕЛЕКТРОМАГНІТНИЙ КЛАПАН 3 WAYS 24V <i>ELECTROVALVE ODE 3 WAYS 24V DC</i>
	6		9972.057	КОРИЧНЕВА ГУМОВА ТРУБКА 5X8 2 МЕТРИ <i>TUBO SILICONE MARRON 5X8 L.2000 MM</i>
	7		20007361	SOLENOID EVT ODE <i>SOLENOID EVT ODE</i>
	8		20007364	SPARE EVT 11032408 <i>SPARE EVT 11032408</i>
	9		20007363	SPARE EVT ODE <i>SPARE EVT ODE</i>
	10		20007362	SPARE CORE EV ODE <i>RIC. NUCLEO EVT ODE</i>
	11		11011454	"T" CONNECTOR FOR BOILER TEAT"" CONNECTOR FOR BOILER TEA <i>RACCORDO A T X CALDAIA TEA</i>
	12		9991.029	NUT FOR RESISTOR <i>DADO X RESISTENZA</i>
	13		9991.085	THERMOSTAT FIXING WASHER <i>RONDELLA FERMATERMOSTATI</i>

## Model Machine

MACSAE341













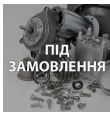

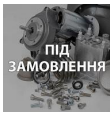







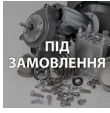

ВЕНДІНГ DIAMANTE RST BLK(10004840 )

	14		NE09.021	THERMOSTAT 150°NC FASTON 90° <i>TERMOSTATO 150°NC FASTON 90°</i>
	15		189428700	THERMOSTAT 175° 1NT-15L-5126 <i>THERMOSTAT 175° 1NT-15L-5126</i>
	16		11033527	BOILER 300CC EVO 1EV+SOLUBLES230 1,4KW <i>BOILER 300CC EVO 1EV+SOLUBLES 230 1,4KW</i>
	17		11007591	RES CALD. V230 W1400 INC.800 <i>RESISTENZA 230V 1400W INC.800</i>
	18		NM04.010	OR ORM 0730-40 FPM 70+-5 IRHDBLACK <i>OR ORM 0730-40 FPM 70 +-5 IRHD NERO</i>
	19		11033133	LOWER CASING BOILER 300CC TEA <i>CORPO INFERIORE CALDAIA 300CC TEA</i>
	20		9111.501	INSULATION WASHER <i>INSULATION WASHER</i>
	21		11033252	PLATE BOILER <i>SUPPORTO CALDAIA UNIFICATO</i>
	22		U005.011	SCREW TE M4,0X10 UNI 5739 GALV. <i>SCREW TE M4,0X10 UNI 5739 GALV.</i>
	22		U046.005	SCREW TE M5,0X10 WITH WASHER <i>SCREW TE M5,0X10 WITH WASHER</i>
	23		NF11.115	BLIND RIVETS <i>BLIND RIVETS</i>
	24		12001052	SCREW TCEI M4,0X6 DIN 912 ZIN <i>SCREW TCEI M4,0X6 DIN 912 ZIN</i>
	25		226830200	RETAIN.SPRING 3 THERM. +THERMAL FUSE <i>RETAIN.SPRING 3 THERM. +THERMAL FUSE</i>
	26		12001810	OR 275 DE.8,04 SILICONE PERNOMANICOTTO <i>OR 275 DE.8,04 SILICONE PERNO MANICOTTO</i>

## Model Machine

MACSAE341

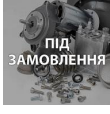
ВЕНДІНГ DIAMANTE RST BLK(10004840 )



















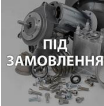

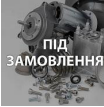



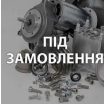

	27		U302.003	МЕТАЛЕВА ГАЙКА M4 UNI 5588 ZNP <i>DADO ESAGONALE M4 UNI 5588 ZNP</i>
	28		11013174	OR ORM 0050-20 FKM 80 FD GREENPEROXIDA <i>OR ORM 0050-20 FKM 80 FD GREEN PEROXIDA</i>
	28		NM01.057	OR ORM 0050-20 IN SILICONE <i>OR ORM 0050-20 IN SILICONE</i>
	29		11033134	ПОГРУЖНИЙ ЗОНД ТЕМПЕРАТУРИ SAECO <i>ASS. SONDA TEMPERATURA AD IMMERSIONE</i>
	30		U023.020	SCREW TCEI M6X20 UNI 5931 ZIN <i>VITE TCEI M6X20 UNI 5931 8.8</i>
	31		NE15.031	MALE TONGUE PLAIN 6,3 D.6,3 <i>MALE TONGUE PLAIN 6,3 D.6,3</i>
	32		11030777	COFFEE BOILER 600CC UPPER ISOLATOR <i>COFFEE BOILER 600CC UPPER ISOLATOR</i>
	33		11000972	OR 3050 FKM 80 FD PEROXIDICA <i>OR 3050 FKM 80 FD PEROXIDICA</i>
	34		11033131	UPPER CASING BOILER 300CC TEA <i>CORPO SURIORE CALDAIA 300CC TEA NUOVO PREZZO 32.64</i>
	35		11030779	ІЗОЛЯЦІЯ НИЖНЬОЇ ЧАСТИНИ БОЙЛЕРА 600CC <i>COFFEE BOILER 600CC UPPER ISOLATOR</i>
	36		9991.059	STRAIGHT BICONE CONNECTOR M 1/8X06 <i>STRAIGHT BICONE CONNECTOR M 1/8X06</i>
	37		9972.236	BLACK SILICONE TUBE 7,5X9,3 L=200 MM <i>BLACK SILICONE TUBE 7,5X9,3 L=200 MM</i>
	38		11029574	ГАЙКА ДЛЯ РУЧНОГО ЗАЖИМУ M14 ДЛЯ ТРУБКИ 4X2 <i>GODRONE FEMMINA M14 X TUBO 4X2</i>

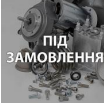

## Model Machine

MACSAE341











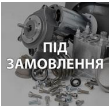

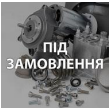













ВЕНДІНГ DIAMANTE RST BLK(10004840 )

	39		11005741	CONNECTOR D.6 BOCCOLA ESTERNA D.6
	40		U109.037	SCREW AUT.TCB 4,8X13 DIN 7981C VITE AUT.TCB 4,8X13 DIN 7981 C NIK
	41		140321462	O-RING 2018 SILICONE OR 2018 IN SILICONE
	42		11005370	PIN FOR MUFF PERNO X MANICOTTO PIN FOR MUFF
	42		11032673	PIN FOR MUFF PERNO X MANICOTTO CAPS
	43		11013173	OR ORM 0090-20 FKM 80 FD GREENPEROXIDA OR ORM 0090-20 FKM 80 FD GREEN PEROXIDA
	43		NM01.035	OR ORM 0090-20 SILICONE OR ORM 0090-20 SILICONE
	44		U302.001	NUT HEXAGONAL M5 UNI 5588 DADO ESAGONALE M5 UNI 5
	45		11006046	PEG FOR BOILER PEG FOR BOILER
	46		U044.013	SCREW TSPC M4,0X12 UNI 7688 GALV. VITE TSPC M4,0X12 UNI 7688 ZNP
	47		20007420	MOTOR BRUSH MOTOR BRUSH
	48		11025696	BEARING RTP 608-2Z BEARING RTP 608-2Z
	49		12002039	SCREW TCBD TORX 20 M4X12 ZN-B VITE TCBD TORX 20 M4X12 ZN-B
	50		11025690	PULLEY D.15 "GRIND 48" PULLEY D.15 "GRIND 48"

## Model Machine

MACSAE341



























ВЕНДІНГ DIAMANTE RST BLK(10004840 )

	51		11027163	MOTOR SUPPORT GRINDERS D.48 <i>MOTOR SUPPORT GRINDERS D.48</i>
	52		11027396	COFFEEGRINDER MOTOR D.48 230V <i>COFFEEGRINDER MOTOR D.48 230V</i>
	52		11027810	COFFEEGRINDER MOTOR D.48 120V <i>MOTORE MACINACAFFE' D.48 120V</i>
	53		U310.004	NUT SELF LOCK.M6 UNI 7473 <i>NUT SELF LOCK.M6 UNI 7473</i>
	54		U043.007	SCREW TCBC M3,0X8 UNI 7687 GALV. <i>SCREW TCBC M3,0X8 UNI 7687 GALV.</i>
	55		U208.002	TOOTHED WASHER 3,3X5,8 UNI 3703 G <i>ROSETTA DENT. 3,3X5,8 UNI 3703 ZNP</i>
	56		11032640	КІЛЬЦЕ ПОМОЛУ ЗА ATL700 TTT Д.48 <i>ASS.GHIERA BLOCCATA X ATL700 TTT D.48</i>
	56		1813.103.A20	RING NUT OF GRIND REGULATION <i>RING NUT OF GRIND REGULATION</i>
	57		11025692	UPPER GRINDING DISK HOLDER "GRIND 48" <i>UPPER GRINDING DISK HOLDER "GRIND 48"</i>
	58		12001617	OR 3206 NBR <i>OR 3206 NBR</i>
	59		11021838	НІЖ КАВОМОЛКИ SAECO D-48 (1ШТ.) <i>FLAT MILL D.47 TEA</i>
	60		11025695	ШНЕК БОЛТИК ЗБІЛЬШЕННЯ "MACINE 48" <i>INCREASE SCREW "GRIND 48"</i>
	61		11027418	SPACER FOR SCREW OF INCREASE <i>SPACER FOR SCREW OF INCREASE</i>
	62		11025699	BEARING RTP 51104 <i>BEARING RTP 51104</i>

## Model Machine

MACSAE341











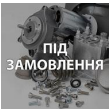



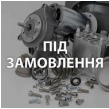

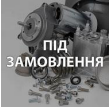







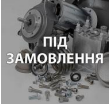

ВЕНДІНГ DIAMANTE RST BLK(10004840 )

	63		11027162	GRINDERS CAP D.48 GRINDERS CAP D.48
	64		U701.011	STEEL SNAP RING 5 UNI 7434 ANELLO ELASTICO 5 UNI 7434
	65		1813.046.050	RUBBER GRIND SUPPORT RUBBER GRIND SUPPORT
	66		12002052	ZN-B TCB SCREW M4X16 ZN-B TCB SCREW M4X16
	67		U023.004	SCREW TCEI M6,0X12 UNI 5931 GALV. VITE TCEI M6,0X12 UNI 5931 Z
	68		128310404	МЕТАЛЕВЕ УБЧАСТЕ КОЛІЩАТКО UNI 8842 A4 WASHER UNI 8842 A4 BURNISHED
	69		U207.004	PLAIN WASHER 4,3X16 UNI 6592 GAL PLAIN WASHER 4,3X16 UNI 6592 GAL
	70	 ПІД ЗАМОВЛЕННЯ	11025689	PULLEY D.40 "GRIND 48" PULLEY D.40 "GRIND 48"
	71		11032130	BELT GRINDER COFFEE BELT GRINDER COFFEE
	72		U208.006	TOOTHED WASHER 6,4X11 UNI 3703 ROSETTA DENT. 6,4X11 UNI 3
	73	 ПІД ЗАМОВЛЕННЯ	12001700	SCREW TCB M4X30 UNI 7687 ZNP SCREW TCB M4X30 UNI 7687 ZNP
	74	 ПІД ЗАМОВЛЕННЯ	11025921	POWER PLUG UNI-EN 28743 D.3X14 POWER PLUG UNI-EN 28743 D.3X14
	75	 ПІД ЗАМОВЛЕННЯ	11027165	КАВОМОЛКА В ЗБОРІ Д 48 SAECO 11027165 COFFEE GRINDER D.48

## Model Machine

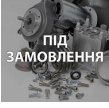
MACSAE341













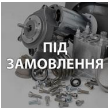



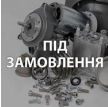









ВЕНДІНГ DIAMANTE RST BLK(10004840 )

	75		11029193	COFFEE GRINDER D.48 120V 60HZ ASS.MACINACAFFE' D.48 TTT 120V60HZ
	76		11025694	SPRING "GRIND 48" SPRING GRIND 48
	77		11033675	DOSER DOSER
	77		11033677	DOSER DOSER
	78		11025691	ТРИМАЧ НИЖНЬОГО НОЖА Д.48 LOWER GRINDING DISK HOLDER GRIND 48
	79		11027451	ПРОКЛАДКА DE=47,4 DI=41,4H=4 IN F ПРОКЛАДКА DE=47,4 DI=41,4H=4 IN F
	80		U116.006	SCREW AUT.PT TCB 3,5X12 WN 1441 ZNP VITE AUT.PT TCB 3,5X12 WN 1441 ZNP
	81		1813.159	ANTIVIBRATION RUBBER ANTIVIBRATION RUBBER
	82		11027164	MOTOR SUPPORT GRINDERS D.48 MOTOR SUPPORT GRINDERS D.48
	83		140321662	O-RING 2021 SILICONE OR 2021 IN SILICONE
	84		11025693	CENTRAL PIN "GRIND 48" CENTRAL PIN "GRIND 48"
	85		12002151	TSP SCREW M3X4 UNI 7688 SS TSP SCREW M3X4 UNI 7688 SS
	86		1813.042.A20	DISPENSER PALLET DISPENSER PALLET
	87		1813.104.A20	ADJUSTMENT SCREW WITH TUBE HOLDER VITE REGOLAZIONE MACININO

## Model Machine

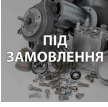
MACSAE341











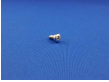











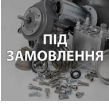

ВЕНДІНГ DIAMANTE RST BLK(10004840 )

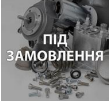
	88		11027186	ЧАСТИНА КРИПЛЕННЯ КАВОМОЛКИ SAECO <i>SHELL CLOSURE BELT</i>
	89		U127.010	SCREW TAPT.TCB M4,0X10 DIN 7500C <i>SCREW TAPT.TCB M4,0X10 DIN 7500C</i>
	90		11025216	ASS.RATIOMOTOR FOR DA 230V FS400 <i>ASS.RATIOMOTOR FOR DA 230V FS400</i>
	91		11033678	COFFEE GRINDER D.48 + DISPENCER <i>COFFEE GRINDER D.48 + DISPENCER</i>
	91		11034067	COFFEE GRINDER D.48 + DISPENCER CRS 120V <i>COFFEE GRINDER D.48 + DISPENCER CRS 120V</i>
	92		9991.037	CAM FOR RATIOMOTOR 1 MICRO <i>CAMMA X MOTORIDUTTORE 1 MICRO</i>
	93		129824002	TCB SCREW M4X10 UNI 7687 ZNP <i>VITE TCB M4X10 UNI 7687 ZNP</i>
	94		U302.002	NUT HEXAGONAL M3 UNI 5588 <i>NUT HEXAGONAL M3 UNI 5588</i>
	95		NE05.066	MICROSWITCH CHERRY D419Q1A <i>МІКРОПЕРЕМИКАЧ РЕДУКТОРА РОБОЧОЇ ГРУПИ</i>
	96		9991.014	CARD FOR MICRO SWITCHES <i>CARTONCINO X MICROINTERRUTTORE</i>
	97		11032817	RATIOMOTOR 30 PACK 230/240-50 <i>RATIOMOTOR 30 PACK 230/240-50</i>
	97		11032818	RATIOMOTOR 30 PACK 120/60 <i>RATIOMOTOR 30 PACK 120/60</i>
	98		129825502	TCB SCREW M4X25 UNI 7687 ZNP <i>TCB SCREW M4X25 UNI 7687 ZNP</i>
	99		11014251	CENTRAL UNIT MOTOR STEEL CARTER <i>CENTRAL UNIT MOTOR STEEL CARTER</i>

## Model Machine

MACSAE341





















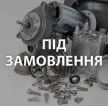





ВЕНДІНГ DIAMANTE RST BLK(10004840 )

	10001		129511903	SCREW TCB 2,9X6,4 DIN 7981 BZNICK SCREW TCB 2,9X6,4 DIN 7981 BZ NICK
	1010		U034.003	SCREW TCI M3,0X20 UNI 6107 GALV. SCREW TCI M3,0X20 UNI 6107 GALV.
	1020		11003524	PLATE FOR MICRO RATIOMOTOR PLATE FOR MICRO RATIOMOTOR
	1020		9991.015	PLATE FOR MICRO PIASTRINA X MICRO
	1030		9991.013	JOINT FOR RATIOMOTOR GIUNTO X MOTORIDUTTORE
	1040		U207.002	PLAIN WASHER 4,3X9 UNI 6592 GAL ROSETTA PIANA 4,3X9 UNI 6592 ZNP
	1050		9121.235.00A	ELECTROMAGNET FOR DISPENSER WITH NUCLEUS ELETTR. PER DOSATORE CON NUCLEO
	1050		9121.235.00F	ELECTROMAGNET X DISPENSER W/NUCLEUS 120V ELECTROMAGNET X DISPENSER W/NUCLEUS 120V
	1060		11033683	DISPENSER SHELL DISPENSER SHELL
	1070		NE15.003	MALE TONGUE PLAIN 6,3 D.5,2 LINGUETTA MASCHIO PIANA 6,3 D.5,2
	1080		129821402	TCB SCREW M3X4 UNI 7687 ZNP TCB SCREW M3X4 UNI 7687 ZNP
	1090		1813.127	SPRING FOR ELECTROMAGNET MOLLA X ELETTRMAGNETE DOSAT
	1100		1813.092	PIN PIN

## Model Machine

MACSAE341

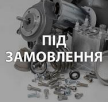
ВЕНДІНГ DIAMANTE RST BLK(10004840 )

	1110		1813.091	PIN FOR DISPENSER REGULATION <i>PIN FOR DISPENSER REGULATION</i>
	1120		1813.043.A20	DISPENSER REGULATION <i>REGOLATORE DOSATORE</i>
	1130		1813.078.A20	ADJUSTMENT LEVER <i>ADJUSTMENT LEVER</i>
	1140		1813.044.A20	PALLET FOR REGULATION <i>PALETTA X REGOLATORE</i>
	1150		NE05.062	MICROSWITCH + WHEEL <i>MICROINTERRUTTORE C/ROTELLA</i>
	1160		U116.004	SCREW AUT.PT TCB 3,0X16 WN 1441 <i>SCREW AUT.PT TCB 3,0X16 WN 1441</i>
	1170	 <small>Liberty</small>	1813.191.A20	DISPENSER COVER <i>COPERTURA DOSATORE</i>
	1180		11033684	OUTSIDE SHELL DISPENSER <i>GUSCIO EST.DOSATORE 1813.041.A20 LAV.</i>
	1190		12000390	SCREW AUT.TCB 2,9X25 DIN 7981C NIK <i>SCREW AUT.TCB 2,9X25 DIN 7981 C NIK</i>
	1200		11033089	CAP SLEEVE CAPS <i>TAPPO MANICOTTO CAPS</i>
	1210		11013431	PHEDRA TTT SLEEVE TTT CIRCUIT <i>PHEDRA TTT SLEEVE TTT CIRCUIT</i>
	1220		U207.001	PLAIN WASHER 5,3X10 UNI 6592 GAL <i>ROSETTA PIANA 5,3X10 UNI 6</i>
	1230		11003525	CAM COFFEE GROUP FRESH BREW <i>CAM COFFEE GROUP FRESH BREW</i>
	1240		U034.001	SCREW TCI M3,0X30 UNI 6107 GALV. <i>VITE TCI M3,0X30 UNI 6107 ZNP</i>

## Model Machine

MACSAE341

БЕНДИНГ DIAMANTE RST BLK(10004840 )



1250

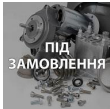

11023413

RATIOMOTOR CRISTALLO600 TTT 120V CSA  
*RATIOMOTOR CRISTALLO600 TTT 120V CSA*



1250

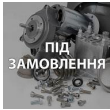

11023414

RATIOMOTOR CRISTALLO600 TTT 230V  
*RATIOMOTOR CRISTALLO600 TTT 230V*



1260



11033220

OR ORM 2043 FKM 80 FD GREEN PEROXIDA  
*OR ORM 2043 FKM 80 FD GREEN PEROXIDA*



# Model Machine

MACSAE341

ВЕНДИНГ DIAMANTE RST BLK(10004840 )

MACSAE341.T.0010

TAVOLA NR. 10 - ARTICOLO ВЕНДИНГ DIAMANTE RST BLK( 10004840 )

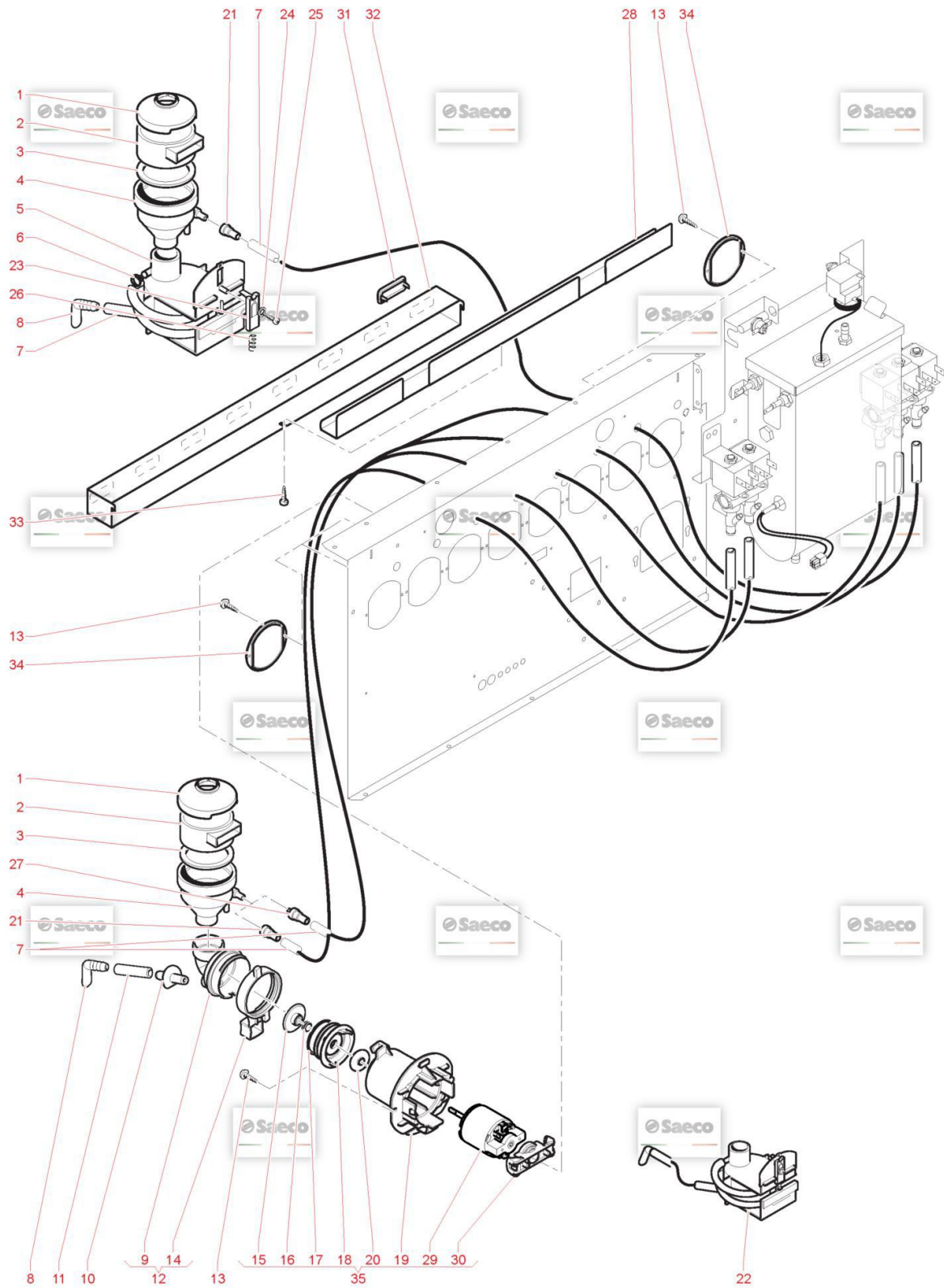

## Model Machine

MACSAE341

БЕНДІНГ DIAMANTE RST BLK(10004840 )

Web Pos. Foto Item - Replace by Description



*Press - CTRL + CLICK go to item in a new window  
Натисніть - Ctrl + права кнопка миші щоб відкрити запчастину в новому вікні*



1



20007361

SOLENOID EVT ODE  
SOLENOID EVT ODE



2



20007362

SPARE CORE EV ODE  
RIC. NUCLEO EVT ODE



3



11005368

IMMERSION PROBE ASS.  
ASS.SONDA TEMPER.AD.IMMERSIONE



4

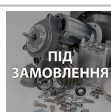

11025409

TUBE ASSEMBLY TEFLON 3X6 L.220MM  
TUBE ASSEMBLY TEFLON 3X6 L.220MM



5

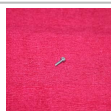

12001179

SCREW TCEI M4,0X12 UNI 5931 8.8 ZIN.  
SCREW TCEI M4,0X12 UNI 5931 8.8 ZIN.



6

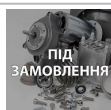

12001181

BICONICAL CONNECT. L M 1/8X06TEA  
BICONICAL CONNECT. L M 1/8X06 TEA



7



9991.029

NUT FOR RESISTOR  
DADO X RESISTENZA



8



11012528

UPPER CASING BOILER 600CC TEA  
UPPER CASING BOILER 600CC TEA



9

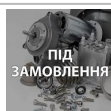

11000972

OR 3050 FKM 80 FD PEROXIDICA  
OR 3050 FKM 80 FD PEROXIDICA



10



11005367

ЕЛЕКТРОВОДОНАГРІВАЧ 230V 1550W  
HEAT ELEMENT BOILER 230V 1550W



11



12000770

OR ORM 4350 VITON  
OR METRICO 4350 IN VITON



12



11012529

LOWER CASING BOILER 600CC TEA  
LOWER CASING BOILER 600CC TEA



13













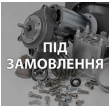

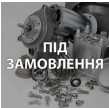













11027089

WATER INLET CONNECTOR  
WATER INLET CONNECTOR

## Model Machine

MACSAE341



























БЕНДІНГ DIAMANTE RST BLK(10004840 )

	14		<b>11025321</b>	BOILER 600CC 230/50 TEA <i>BOILER ASS.CRISTALLO600 600CC 230/50 TEA</i>
	15		<b>11033252</b>	PLATE BOILER <i>SUPPORTO CALDAIA UNIFICATO</i>
	16		<b>U207.001</b>	PLAIN WASHER 5,3X10 UNI 6592 GAL <i>ROSETTA PIANA 5,3X10 UNI 6</i>
	17		<b>U005.011</b>	SCREW TE M4,0X10 UNI 5739 GALV. <i>SCREW TE M4,0X10 UNI 5739 GALV.</i>
	18		<b>11012534</b>	TEA ELECTROVALVE 2/3 WAY N.C. <i>TEA ELECTROVALVE 2/3 WAY N.C.</i>
	19		<b>12001052</b>	SCREW TCEI M4,0X6 DIN 912 ZIN <i>SCREW TCEI M4,0X6 DIN 912 ZIN</i>
	20		<b>226760100</b>	RETAINING SPRING 3 THERMOSTATS <i>RETAINING SPRING 3 THERMOSTATS</i>
	21		<b>9991.085</b>	THERMOSTAT FIXING WASHER <i>RONDELLA FERMATERMOSTATI</i>
	22		<b>NE09.021</b>	THERMOSTAT 150°NC FASTON 90° <i>TERMOSTATO 150°NC FASTON 90°</i>
	23		<b>189428700</b>	THERMOSTAT 175° 1NT-15L-5126 <i>THERMOSTAT 175° 1NT-15L-5126</i>
	24		<b>U023.020</b>	SCREW TCEI M6X20 UNI 5931 ZIN <i>VITE TCEI M6X20 UNI 5931 8.8</i>
	25		<b>NE15.031</b>	MALE TONGUE PLAIN 6,3 D.6,3 <i>MALE TONGUE PLAIN 6,3 D.6,3</i>
	26		<b>U204.001</b>	ELAS. WASHER 6,4X11,4 UNI 1751ZIN <i>ELAS. WASHER 6,4X11,4 UNI 1751 ZIN</i>
	27		<b>9111.501</b>	INSULATION WASHER <i>INSULATION WASHER</i>

## Model Machine

MACSAE341

ВЕНДІНГ DIAMANTE RST BLK(10004840 )

	28		11030778	COFFEE BOILER 600CC UPPER ISOLATOR <i>ISOLANTE PERIMETR.CALDAIA 600CC VENDING</i>
	29		U302.004	NUT HEXAGONAL M6 UNI 5588 <i>DADO ESAGONALE M6 UNI 5</i>
	30		NF11.115	BLIND RIVETS <i>BLIND RIVETS</i>
	31		11005743	KNURLED FEMALE HAND BOLT M14 <i>GODRONE FEMMINA M14</i>
	32		U109.037	SCREW AUT.TCB 4,8X13 DIN 7981C <i>VITE AUT.TCB 4,8X13 DIN 7981 C NIK</i>
	33		11005370	PIN FOR MUFF <i>PERNO X MANICOTTO PIN FOR MUFF</i>
	34		140321462	O-RING 2018 SILICONE <i>OR 2018 IN SILICONE</i>
	35		11005741	CONNECTOR D.6 <i>BOCCOLA ESTERNA D.6</i>
	36		11013173	OR ORM 0090-20 FKM 80 FD GREENPEROXIDA <i>OR ORM 0090-20 FKM 80 FD GREEN PEROXIDA</i>
	37		U302.001	NUT HEXAGONAL M5 UNI 5588 <i>DADO ESAGONALE M5 UNI 5</i>
	38		U302.003	МЕТАЛЕВА ГАЙКА M4 UNI 5588 ZNP <i>DADO ESAGONALE M4 UNI 5588 ZNP</i>
	39		11013174	OR ORM 0050-20 FKM 80 FD GREENPEROXIDA <i>OR ORM 0050-20 FKM 80 FD GREEN PEROXIDA</i>
	40		11006046	PEG FOR BOILER <i>PEG FOR BOILER</i>

## Model Machine

MACSAE341

ВЕНДІНГ DIAMANTE RST BLK(10004840 )



41



U044.013

SCREW TSPC M4,0X12 UNI 7688 GALV.  
VITE TSPC M4,0X12 UNI 7688 ZNP



42

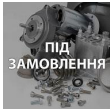

20007370

SPARE EVT 11012534  
SPARE EVT 11012534



43

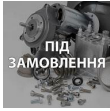

20007363

SPARE EVT ODE  
SPARE EVT ODE



44



11030776

COFFEE BOILER 600CC UPPER ISOLATOR  
ISOLANTE SUP.CALDAIA 600CC VENDING

# Model Machine

MACSAE341

ВЕНДІНГ DIAMANTE RST BLK(10004840 )

MACSAE341.T.0011

TAVOLA NR. 11 - ARTICOLO ВЕНДІНГ DIAMANTE RST BLK( 10004840 )

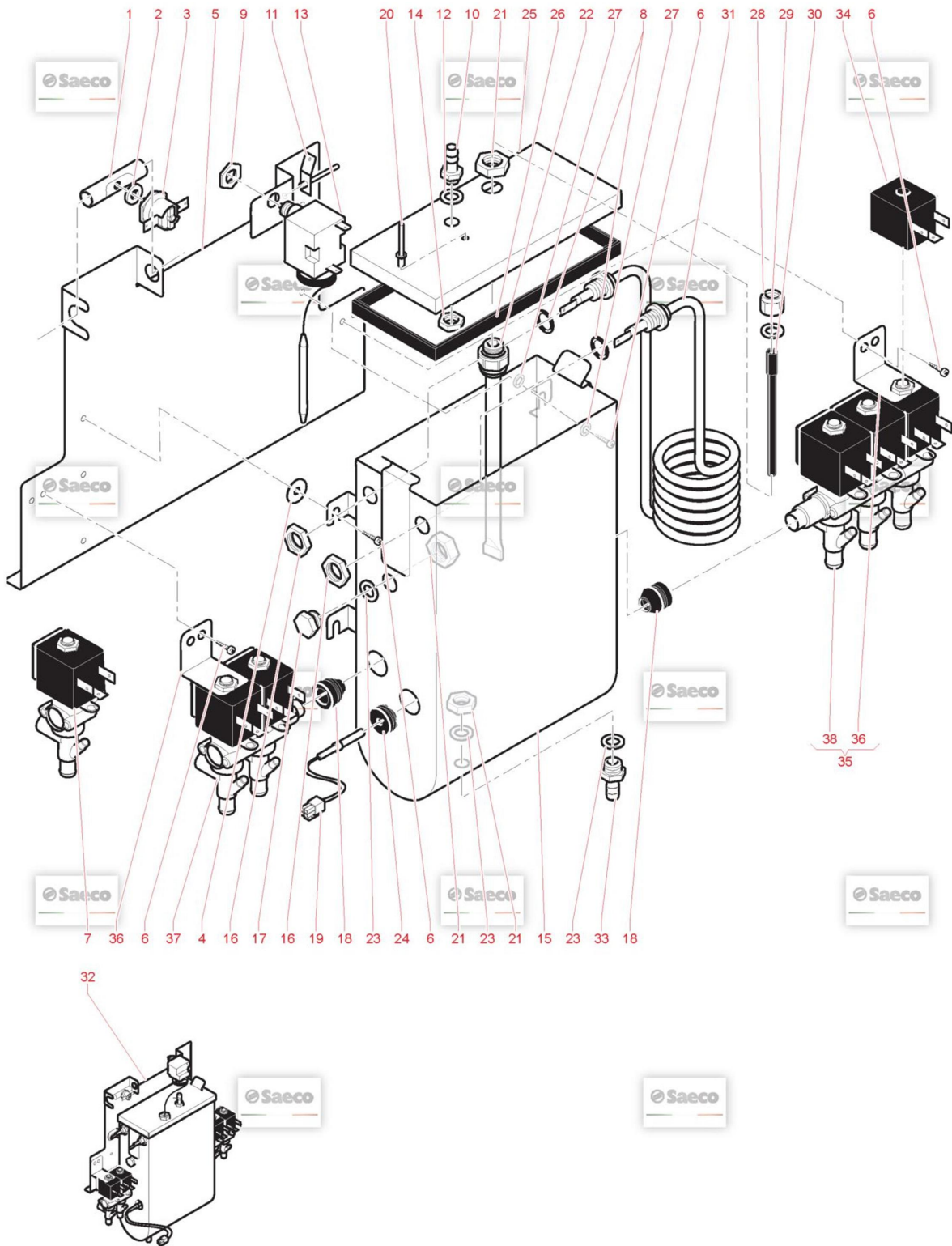

## Model Machine

MACSAE341

БЕНДІНГ DIAMANTE RST BLK(10004840 )

Web Pos. Foto Item - Replace by Description



*Press - CTRL + CLICK go to item in a new window  
Натисніть - Ctrl + права кнопка миші щоб відкрити запчастину в новому вікні*



1



20007361

SOLENOID EVT ODE  
SOLENOID EVT ODE



2



20007362

SPARE CORE EV ODE  
RIC. NUCLEO EVT ODE



3



11005368

IMMERSION PROBE ASS.  
ASS.SONDA TEMPER.AD.IMMERSIONE



4

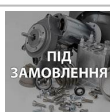

11025409

TUBE ASSEMBLY TEFLON 3X6 L.220MM  
TUBE ASSEMBLY TEFLON 3X6 L.220MM



5

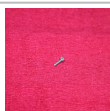

12001179

SCREW TCEI M4,0X12 UNI 5931 8.8 ZIN.  
SCREW TCEI M4,0X12 UNI 5931 8.8 ZIN.



6

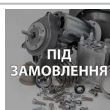

U204.001

ELAS. WASHER 6,4X11,4 UNI 1751ZIN  
ELAS. WASHER 6,4X11,4 UNI 1751 ZIN



7



9991.029

NUT FOR RESISTOR  
DADO X RESISTENZA



8



11012528

UPPER CASING BOILER 600CC TEA  
UPPER CASING BOILER 600CC TEA



9

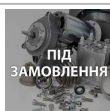

11000972

OR 3050 FKM 80 FD PEROXIDICA  
OR 3050 FKM 80 FD PEROXIDICA



10

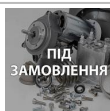

11005374

HEAT ELEMENT BOILER 120V 1100W  
HEAT ELEMENT BOILER 120V 1100W



11



12000770

OR ORM 4350 VITON  
OR METRICO 4350 IN VITON



12



11012529

LOWER CASING BOILER 600CC TEA  
LOWER CASING BOILER 600CC TEA



13













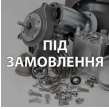

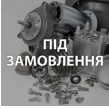



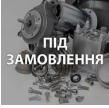





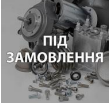



11027089

WATER INLET CONNECTOR  
WATER INLET CONNECTOR

## Model Machine

MACSAE341

ВЕНДІНГ DIAMANTE RST BLK(10004840 )



























	14		<b>11034994</b>	BOILER CRS600 EVO CC120/60 TEA <i>ASS.CALD.600CC DOO CRS600 EVO TEA 120V</i>
	15		<b>11033252</b>	PLATE BOILER <i>SUPPORTO CALDAIA UNIFICATO</i>
	16		<b>U207.001</b>	PLAIN WASHER 5,3X10 UNI 6592 GAL <i>ROSETTA PIANA 5,3X10 UNI 6</i>
	17		<b>U046.007</b>	SCREW TEFZ M4,0X12 GALV. <i>SCREW TEFZ M4,0X12 GALV.</i>
	18		<b>11012534</b>	TEA ELECTROVALVE 2/3 WAY N.C. <i>TEA ELECTROVALVE 2/3 WAY N.C.</i>
	19		<b>12001052</b>	SCREW TCEI M4,0X6 DIN 912 ZIN <i>SCREW TCEI M4,0X6 DIN 912 ZIN</i>
	20		<b>226760100</b>	RETAINING SPRING 3 THERMOSTATS <i>RETAINING SPRING 3 THERMOSTATS</i>
	21		<b>9991.085</b>	THERMOSTAT FIXING WASHER <i>RONDELLA FERMATERMOSTATI</i>
	22		<b>NE09.021</b>	THERMOSTAT 150°NC FASTON 90° <i>TERMOSTATO 150°NC FASTON 90°</i>
	23		<b>189428700</b>	THERMOSTAT 175° 1NT-15L-5126 <i>THERMOSTAT 175° 1NT-15L-5126</i>
	24		<b>U023.020</b>	SCREW TCEI M6X20 UNI 5931 ZIN <i>VITE TCEI M6X20 UNI 5931 8.8</i>
	25		<b>NE15.031</b>	MALE TONGUE PLAIN 6,3 D.6,3 <i>MALE TONGUE PLAIN 6,3 D.6,3</i>
	26		<b>11030776</b>	COFFEE BOILER 600CC UPPER ISOLATOR <i>ISOLANTE SUP.CALDAIA 600CC VENDING</i>
	27		<b>9111.501</b>	INSULATION WASHER <i>INSULATION WASHER</i>



## Model Machine

MACSAE341

ВЕНДІНГ DIAMANTE RST BLK(10004840 )

	28		11030778	COFFEE BOILER 600CC UPPER ISOLATOR <i>ISOLANTE PERIMETR.CALDAIA 600CC VENDING</i>
	29		U302.004	NUT HEXAGONAL M6 UNI 5588 <i>DADO ESAGONALE M6 UNI 5</i>
	30		NF11.115	BLIND RIVETS <i>BLIND RIVETS</i>
	31		11005743	KNURLED FEMALE HAND BOLT M14 <i>GODRONE FEMMINA M14</i>
	32		U109.037	SCREW AUT.TCB 4,8X13 DIN 7981C <i>VITE AUT.TCB 4,8X13 DIN 7981 C NIK</i>
	33		11005370	PIN FOR MUFF <i>PERNO X MANICOTTO PIN FOR MUFF</i>
	34		140321462	O-RING 2018 SILICONE <i>OR 2018 IN SILICONE</i>
	35		11013173	OR ORM 0090-20 FKM 80 FD GREENPEROXIDA <i>OR ORM 0090-20 FKM 80 FD GREEN PEROXIDA</i>
	36		U302.001	NUT HEXAGONAL M5 UNI 5588 <i>DADO ESAGONALE M5 UNI 5</i>
	37		11005741	CONNECTOR D.6 <i>BOCCOLA ESTERNA D.6</i>
	38		U302.003	МЕТАЛЕВА ГАЙКА M4 UNI 5588 ZNP <i>DADO ESAGONALE M4 UNI 5588 ZNP</i>
	39		11013174	OR ORM 0050-20 FKM 80 FD GREENPEROXIDA <i>OR ORM 0050-20 FKM 80 FD GREEN PEROXIDA</i>
	40		11006046	PEG FOR BOILER <i>PEG FOR BOILER</i>

## Model Machine

MACSAE341

ВЕНДІНГ DIAMANTE RST BLK(10004840 )



41



U044.013

SCREW TSPC M4,0X12 UNI 7688 GALV.  
VITE TSPC M4,0X12 UNI 7688 ZNP



42

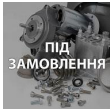

12001181

BICONICAL CONNECT. L M 1/8X06TEA  
BICONICAL CONNECT. L M 1/8X06 TEA



43

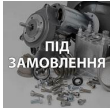

20007370

SPARE EVT 11012534  
SPARE EVT 11012534



44

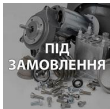

20007363

SPARE EVT ODE  
SPARE EVT ODE

# Model Machine

MACSAE341

ВЕНДИНГ DIAMANTE RST BLK(10004840 )

MACSAE341.T.0012

TAVOLA NR. 12 - ARTICOLO ВЕНДИНГ DIAMANTE RST BLK( 10004840 )

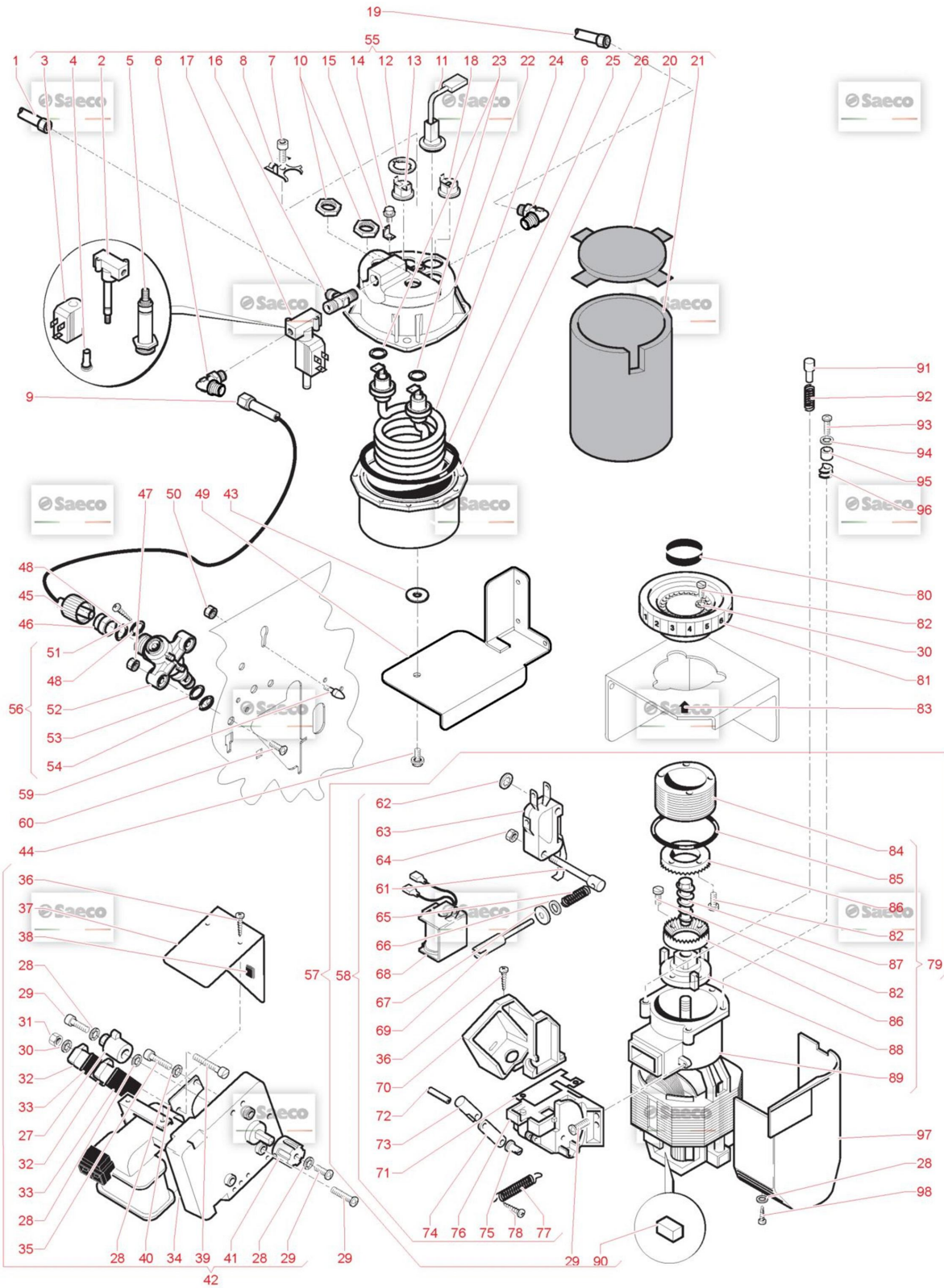

## Model Machine

MACSAE341

БЕНДІНГ DIAMANTE RST BLK(10004840 )

Web Pos. Foto Item - Replace by Description



Press - CTRL + CLICK go to item in a new window

Натисніть - Ctrl + права кнопка миші щоб відкрити запчастину в новому вікні



1

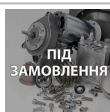

11027367

БЛОК ВИДАЧІ СТАКАНІВ D.80  
DISPENSER GLASSES D.80



2



12002034

KNOB WITH BUSH M5  
KNOB WITH BUSH M5



3



11010585

CENTRAL PIN FOR CUP COLUMN  
CENTRAL PIN FOR CUP COLUMN



4



11028032

TANK LID GLASSES  
TANK LID GLASSES



5

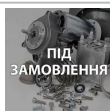

U207.009

PLAIN WASHER 5,5X15 UNI 6593 GA  
PLAIN WASHER 5,5X15 UNI 6593 GA



6



U043.021

SCREW TCBC M5,0X8 UNI 7687 GALV.  
VITE TCBC M5,0X8 UNI 7687 ZNP



7



11005072

CUP TUBE FIXING SPRING  
CUP TUBE FIXING SPRING



8



11001422

TUBE PVC 80X1.5 L=705  
TUBE PVC 80X1.5 L=705



9



NM02.002

OR 4412 EPDM  
OR 4412 EPDM



10



11000976

TANK DRINKS  
SERBATOIO BICCHIERI UNIFICATO



11

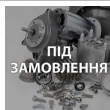

1813.162

BRACKET STOP DISPENCER  
BRACKET STOP DISPENCER



12



U110.004

SCREW AUT.TCB 3,5X6,5 DIN 7981F  
VITE AUT.TCB 3,5X6,5 DIN 7981 F NIK



13

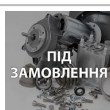











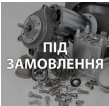















11004750

ASS. CUP DISPENSER 120V D.73  
ASS. CUP DISPENSER 120V D.73

## Model Machine

MACSAE341

















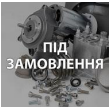

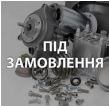





БЕНДІНГ DIAMANTE RST BLK(10004840 )

	13		<b>9110.140.A2A</b>	CUP DISTRIBUTOR <i>ASS.DISTRIBUTORE BICCHIERI FS400</i>
	14		<b>U034.001</b>	SCREW TCI M3,0X30 UNI 6107 GALV. <i>VITE TCI M3,0X30 UNI 6107 ZNP</i>
	15		<b>11000785</b>	ВЕРХНІЙ КОРПУС БЛОКУ ВИДАЧІ СТАКАНІВ <i>CORPO SUPERIORE DISTRIBUTORE BICCHIERI</i>
	15		<b>11000868</b>	CASING UPPER CUP DISTRIBUTOR UL <i>CASING UPPER CUP DISTRIBUTOR UL</i>
	16		<b>NE05.065</b>	MICROSWITCH CHERRY D41R-QGAD_61 <i>MICROINTERRUTTORE CHERRY D419Q1A ATLANTE CRISTALLO NEXTAGE</i>
	17		<b>1813.067.A20</b>	LEVER <i>LEVA PRESENZA BICCHIERI</i>
	18		<b>11000642</b>	TUBE FOR BASKET GLASSES <i>CANOTTO PER CESTELLO BICCHIERI</i>
	19		<b>U142.008</b>	PANELVIT TSP 3,5X12 DIN 7505 AGAL <i>PANELVIT TSP 3,5X12 DIN 7505 A GAL</i>
	20		<b>11001467</b>	ADHESIVE LABEL PVC 54X30 MM <i>ADHESIVE LABEL PVC 54X30 MM</i>
	21		<b>9121.226.00A</b>	MOTOR SAIA UDS 5 RPM 220V <i>MOTORE SAIA UDS 5 RPM 220V</i>
	21		<b>9121.226.00F</b>	RATIOMOTOR SAIA UDS 5RPM 120V60HZ <i>RATIOMOTOR SAIA UDS 5RPM 120V 60HZ</i>
	22		<b>NE05.064</b>	MICROSWITCH SAIA V4NC <i>MICROINTERRUTTORE SAIA V4NC</i>
	23		<b>11000391</b>	MOTOR SAIA UDS1ND5M75CAN2WZ239 <i>MOTORE SAIA UDS1ND5M75CAN2WZ239</i>
	23		<b>11000481</b>	MOTOR SAIA CUP DISPENSER D6 PIVOT 120V <i>MOTOR SAIA CUP DISPENSER D6 PIVOT 120V</i>

## Model Machine

MACSAE341











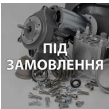





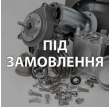

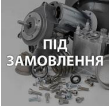



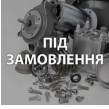

ВЕНДІНГ DIAMANTE RST BLK(10004840 )

	24		<b>U116.005</b>	SCREW AUT.PT TCB 3,0X8 WN 1441 VITE AUT.PT TCB 3,0X8 WN 1441 ZNP
	25		<b>U324.005</b>	NUT M3 FLANGED INDENTED BASE DADO M3 FLANGIATO BASE DENTELLATA
	26		<b>U212.006</b>	WASHER 3,2X11X0,5 ZNP WASHER 3,2X11X0,5 ZNP
	27	 ПІД ЗАМОВЛЕННЯ	<b>NF11.002</b>	SELF LOCK STRIP W=2.5 L=98 SELF LOCK STRIP W=2.5 L=98
	28	 ПІД ЗАМОВЛЕННЯ	<b>144320200</b>	SELF LOCK STRIP W=2.6 L=200 SELF LOCK STRIP W=2.6 L=200
	29		<b>U109.005</b>	SCREW AUT.TCB 3,5X16 DIN 7981C VITE AUT.TCB 3,5X16 DIN 798
	30		<b>1863.066.A20</b>	DISENGAGE CAM GLASSES DISENGAGE CAM GLASSES
	31		<b>U201.001</b>	PLAIN WASHER 3,2X9 DIN 7349 GALV. PLAIN WASHER 3,2X9 DIN 7349 GALV.
	32	 ПІД ЗАМОВЛЕННЯ	<b>1813.068.A20</b>	TOOTHED WHEEL TOOTHED WHEEL
	33	 ПІД ЗАМОВЛЕННЯ	<b>1813.062.A20</b>	LOWER CASING DISPENSER GLASSES LOWER CASING DISPENSER GLASSES
	33	 ПІД ЗАМОВЛЕННЯ	<b>1813.308.050</b>	LOVER CASING DISPENSER GLASSESUL LOVER CASING DISPENSER GLASSES UL
	34	 ПІД ЗАМОВЛЕННЯ	<b>11003955</b>	FS400 UL ASSEMBL.CUP DISP. GROUP FS400 UL ASSEMBL.CUP DISP. GROUP
	34	 ПІД ЗАМОВЛЕННЯ	<b>9110.151.A2A</b>	DISPENSER ASS. DISPENSER ASS.

## Model Machine

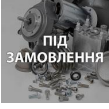
MACSAE341

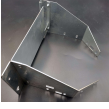
ВЕНДІНГ DIAMANTE RST BLK(10004840 )

	35		11000786	RETAINING RING <i>RETAINING RING</i>
	36		1813.072.A20	SNAIL FOR GLASSES D.70 <i>CHIOCCIOLA X BICCHIERI</i>
	36		1813.192.050	SNAIL FOR GLASSES D.73 <i>CHIOCCIOLA X BICCHIERI D.73</i>
	37		1813.073.A20	TOOTHED WHEEL FOR SNAIL <i>TOOTHED WHEEL FOR SNAIL</i>
	38		11000833	SNAIL SUPPORT <i>SNAIL SUPPORT</i>
	39		1813.074.A20	TOOTHED WHEEL <i>TOOTHED WHEEL</i>
	40		11000835	ASS.SNAIL SUPPORT <i>ASS.SNAIL SUPPORT</i>
	40		11000863	ASSEMBLY SUPPORT <i>ASSEMBLY SUPPORT</i>
	41		11027368	КРИШКА КАСЕТИ СТАКАНІВ D.80 <i>COPERCHIO CESTELLO BICCHIERI D.80</i>
	42		11028131	ТРУБКА PVC 84X1.5 L=620 <i>TUBO PVC 84X1.5 L=620</i>
	43		11026360	BASE GLASSES BASKET 4 COLUMN D.80 <i>BASE CESTELLO BICCHIERI 4 COL. D.80</i>
	44		11034442	ТРИМАЧ ДИСПЕНСОРУ СТАКАНІВ D83 <i>SUPPORT CUP DISPENCER D83</i>
	45		U110.005	SCREW AUT.TCB 3,9X9,5 DIN 7981F <i>VITE AUT.TCB 3,9X9,5 DIN 798</i>

# Model Machine

MACSAE341

ВЕНДИНГ DIAMANTE RST BLK(10004840 )

MACSAE341.T.0013

TAVOLA NR. 13 - ARTICOLO ВЕНДИНГ DIAMANTE RST BLK( 10004840 )

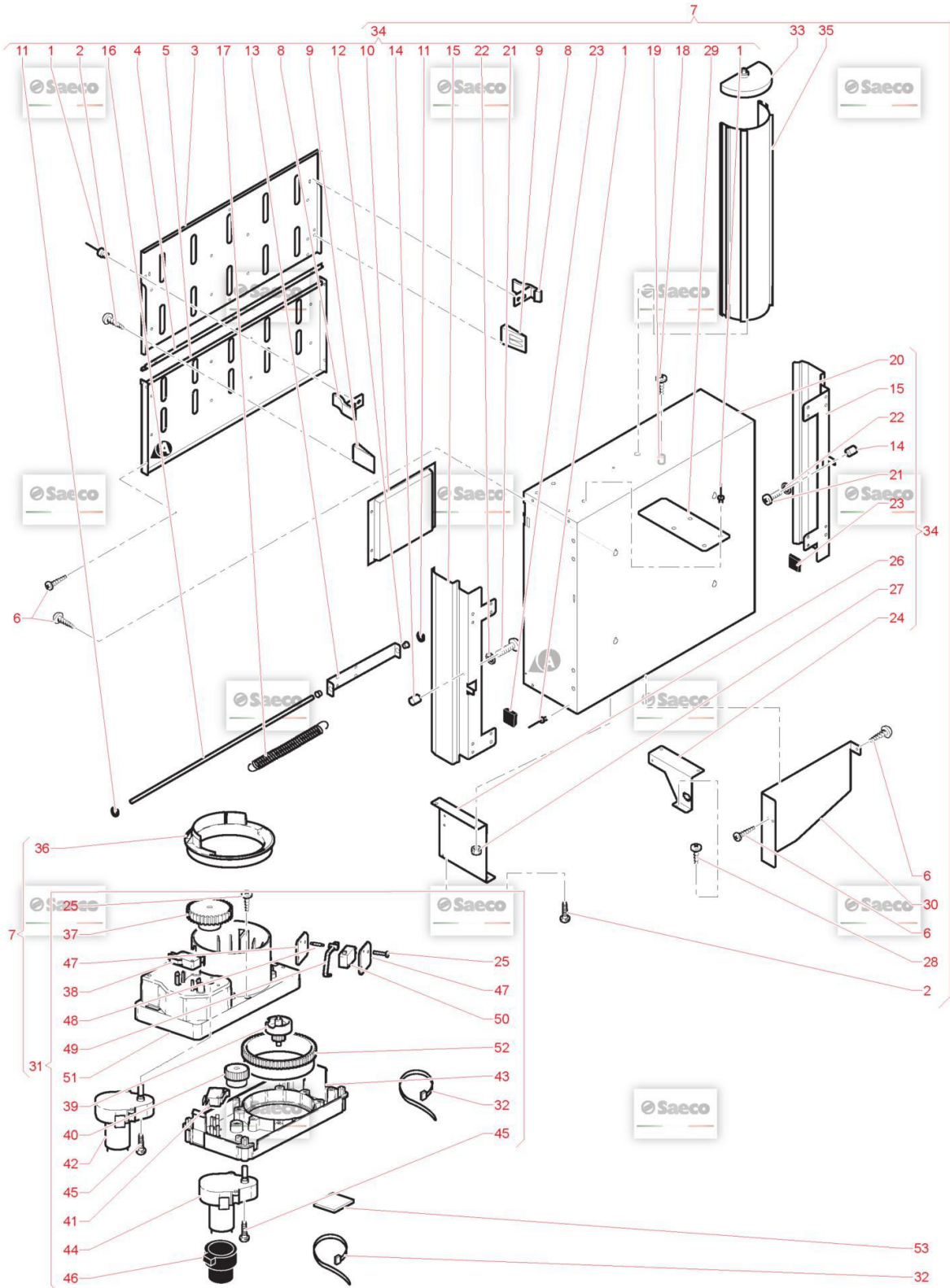



## Model Machine

MACSAE341

ВЕНДІНГ DIAMANTE RST BLK(10004840 )

Web Pos. Foto Item - Replace by Description



Press - CTRL + CLICK go to item in a new window

Натисніть - Ctrl + права кнопка миші щоб відкрити запчастину в новому вікні



1



9111.683

SOLUBLE COVER

COPERCHIETTO SOLUBILI



2



9111.696

COVER SUGAR CONTAINER

COPERCHIO CONTENITORE ZUCCHERO



3



11004610

EXTENSION FOR CONTAINER SUGAR

PROLUNGAX CONTENITORE ZUCCHERO



4

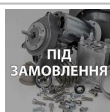

U117.003

SCREW AUT.PT TCB 2.5X10 WN 1442

SCREW AUT.PT TCB 2.5X10 WN 1442



5



U110.004

SCREW AUT.TCB 3,5X6,5 DIN 7981F

VITE AUT.TCB 3,5X6,5 DIN 7981 F NIK



6



9111.685

SUGAR CONTAINER

CONTENITORE ZUCCHERO



7



9111.630.060

BUSH FOR POWDERS TANK

BOCCOLA X SERBAT.POLVERI C/AGGANCI



8



9111.338.270

BULKHEAD FOR APERT. CLOSURE ORANGE

PARATIA CHIUSURA BOCCHETTA ARANCIO



9



9111.629.060

APERTURE FOR SOLUBLES HOPPER

APERTURE FOR SOLUBLES HOPPER



10



11032878

ШЕСТЕРНЯ КОНТЕЙНЕРА ДЛЯ ЦУКРУ (EX 9111.725)

CONTAINER WHEEL SUGAR BPA FREE



11



11012130

BACK BUSH REINFORCE

BACK BUSH REINFORCE



12



NM03.013

OR 2,3X15 NBR

OR 2,3X15 NBR



13



9111.726











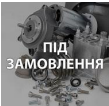

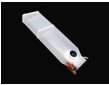













SCROLL SCREW SUGAR CONTAINER

COCLEA CONTENITORE ZUCCHERO

## Model Machine

MACSAE341















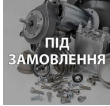

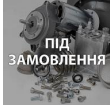





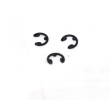

ВЕНДІНГ DIAMANTE RST BLK(10004840 )

	14	 ПІД ЗАМОВЛЕННЯ	<b>9111.646</b>	ADHESIVE FOR TANK <i>ADHESIVE FOR TANK</i>
	15		<b>11005129</b>	ASSEMBLY SUGAR CONTAINER <i>ASS.CONT.ZUCCHERO CON PROLUNGA</i>
	16		<b>9121.106.00P</b>	SUGAR RATIOMOTOR 24V DC <i>MOTORIDUTTORE ZUCCHERO 24V D.C.</i>
	17	 ПІД ЗАМОВЛЕННЯ	<b>U110.007</b>	SCREW AUT.TCB 2,9X16 DIN 7981F ZNP <i>SCREW AUT.TCB 2,9X16 DIN 7981 F ZNP</i>
	18		<b>NE05.002</b>	МІКРОВИМИКАЧ ДЛЯ КАВОМАШИНИ EF83161.8 <i>MICROINTERRUTTORE</i>
	19		<b>11033196</b>	СУПОРТ МЕХАНІЗМА МЕШАЛКИ САХАРА <i>SUPP.PALETTIERA</i>
	20		<b>9111.699</b>	ПЕРЕХОДНИК-ДЕРЖАТЕЛЬ ДЛЯ ТРУБКИ ВИДАЧИ САХАРА КОФЕМАШИ... <i>BOCCHETTA TUBO ZUCCHERO</i>
	21		<b>9111.686.A20</b>	SUPPORT SUGAR CONVEYER <i>SUPPORTO BASCULINA ZUCCHERO</i>
	22	 ПІД ЗАМОВЛЕННЯ	<b>U116.004</b>	SCREW AUT.PT TCB 3,0X16 WN 1441 <i>SCREW AUT.PT TCB 3,0X16 WN 1441</i>
	23		<b>11000388</b>	KNOB M3 SUGAR CONVEYER <i>POMELLO M 3 BASCULINA ZUCCHERO</i>
	24		<b>11000389</b>	GRAINED PIVOT SUGAR COVEYER <i>PERNO ZIGRINATO BASCULINA ZUCCHERO</i>
	25		<b>9111.690</b>	SUGAR CONVEYER <i>BASCULINA ZUCCHERO</i>
	26	 ПІД ЗАМОВЛЕННЯ	<b>9111.553</b>	SELF-ENERGIZING SPRING FOR TUBE D.2 <i>SELF-ENERGIZING SPRING FOR TUBE D.2</i>
	27		<b>123160302</b>	NUT M3 HIGH UNI 5587 GALVANIZED <i>NUT M3 HIGH UNI 5587 GALVANIZED</i>

## Model Machine

MACSAE341











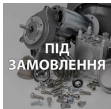















ВЕНДІНГ DIAMANTE RST BLK(10004840 )

	28		9111.700	SUGAR TUBE <i>TUBO ZUCCHERO</i>
	29		9111.697	CONNECTOR SUGAR TUBE <i>RACCORDO TUBO ZUCCHERO</i>
	30		11033206	DISTRIBUTOR 25RPM <i>DISTRIBUTOR 25RPM</i>
	30		11033212	SUGAR/SPOONS DISPENSER 120V 25RPM UL <i>ASS.DISTR.PALETTE/ZUCCH.120V 25RPM UL</i>
	31		U116.006	SCREW AUT.PT TCB 3,5X12 WN 1441 ZNP <i>VITE AUT.PT TCB 3,5X12 WN 1441 ZNP</i>
	32		9111.705	SPHERICAL PIN <i>PERNO SFERICO</i>
	33		U201.001	PLAIN WASHER 3,2X9 DIN 7349 GALV. <i>PLAIN WASHER 3,2X9 DIN 7349 GALV.</i>
	34		9111.727	BULKHEAD SUGAR CONVEYER <i>PARATIA BASCULINA ZUCCHERO</i>
	35		U701.011	STEEL SNAP RING 5 UNI 7434 <i>ANELLO ELASTICO 5 UNI 7434</i>
	36		9111.691	CONNECTING ROD SUGAR DISPENSER <i>BIELLA DISTRIBUTORE ZUCCHERO</i>
	37		11004295	KNOB FOR SUGAR CONNECTING RODPIPE <i>POMELLO BLOCCAGGIO BIELLA TUBO ZUCCH.</i>
	38		9111.688.A20	CAM SUGAR DISPENSER <i>CAMMA DISTRIBUTORE ZUCCHERO</i>
	39		9111.668	STIRRER DISP.COUNTERWEIGHT D.10 <i>CONTRAPPESO PALETTE D.10</i>

## Model Machine

MACSAE341











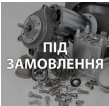

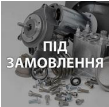



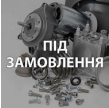







ВЕНДІНГ DIAMANTE RST BLK(10004840 )

	39		9111.669	STIRRER DISP.COUNTERWEIGHT D.10 <i>STIRRER DISP.COUNTERWEIGHT D.10</i>
	39		9111.745	STIRRER DISP.COUNTERWEIGHT <i>CONTRAPPESO PALETTE L=113MM</i>
	40		9111.707	REINFORCING PLATE <i>PIASTRA RINFORZO PALETTIERA</i>
	41		9111.694	JOINT WITH GEAR <i>GIUNTO CON INGRANAGGIO</i>
	42		U116.005	SCREW AUT.PT TCB 3,0X8 WN 1441 <i>VITE AUT.PT TCB 3,0X8 WN 1441 ZNP</i>
	43		9111.695	GEAR Z40 <i>INGRANAGGIO Z 40</i>
	44		9111.737	ОПОРА ТРУБКА ПЛАСТИКОВАЯ <i>SUPPORT</i>
	45		9111.687.A20	GEAR COVER <i>COPERCHIO INGRANAGGI</i>
	46		U701.006	ФІКСУЮЧА СКОБА 3,2 (ЗАПІЗО) SAECO <i>ANELLO ELASTICO 3,2</i>
	47		9111.730	SPRING <i>MOLLA ESPULSORE PALETTE</i>
	48		9111.376	PIN FOR STIRRER EXPELLER <i>PIN FOR STIRRER EXPELLER</i>
	49		11011240	STIRRER EXPELLER BLACK NEW <i>STIRRER EXPELLER BLACK NEW</i>
	50		11031341	SPRING <i>SPRING</i>
	51		11002209	PIN <i>PIN</i>

## Model Machine

MACSAE341

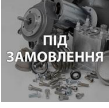
ВЕНДІНГ DIAMANTE RST BLK(10004840 )

	52		11009886	STIRRER GUIDE CRISTALLO400 NEW <i>STIRRER GUIDE CRISTALLO400 NEW</i>
	52		11009887	STIRRER GUIDE CRISTALLO600 NEW <i>STIRRER GUIDE CRISTALLO600 NEW</i>
	53		11025411	CRISTALLO SPOON'S MOTOR COVER <i>CRISTALLO SPOON'S MOTOR COVER</i>
	54		11032949	BRACKET FOR STIRRER GUIDE FS4N <i>BRACKET FOR STIRRER GUIDE FS4N</i>
	55		11001420	STIRRER GUIDE CRISTALLO600 <i>STIRRER GUIDE CRISTALLO600</i>
	55		9111.693	STIRRER GUIDE <i>STIRRER GUIDE</i>
	56		11007444	CARTER <i>CARTER</i>
	57		11033191	GEARMOTOR MECHTEX 25 RPM <i>MOTORIDUTTORE MECHTEX 25 RPM</i>
	58		9111.698.A20	STIRRER SLIDE <i>SCIVOLO PALETTE</i>
	59		9161.082	RUBBER COUPLER <i>AGGANCIO IN GOMMA</i>
	60		U207.003	PLAIN WASHER 3,2X7 UNI 6592 GALV. <i>PLAIN WASHER 3,2X7 UNI 6592 GALV.</i>
	61		11025089	PLATE REINFORCEMENT <i>PIASTRINA RINFORZO ESPULSORE</i>
	62		U110.003	SCREW AUT.TCB 3,5X9,5 DIN 7981F <i>VITE AUT.TCB 3,5X9,5 DIN 798</i>

# Model Machine

MACSAE341

ВЕНДІНГ DIAMANTE RST BLK(10004840 )

MACSAE341.T.0014

TAVOLA NR. 14 - ARTICOLO ВЕНДІНГ DIAMANTE RST BLK( 10004840 )

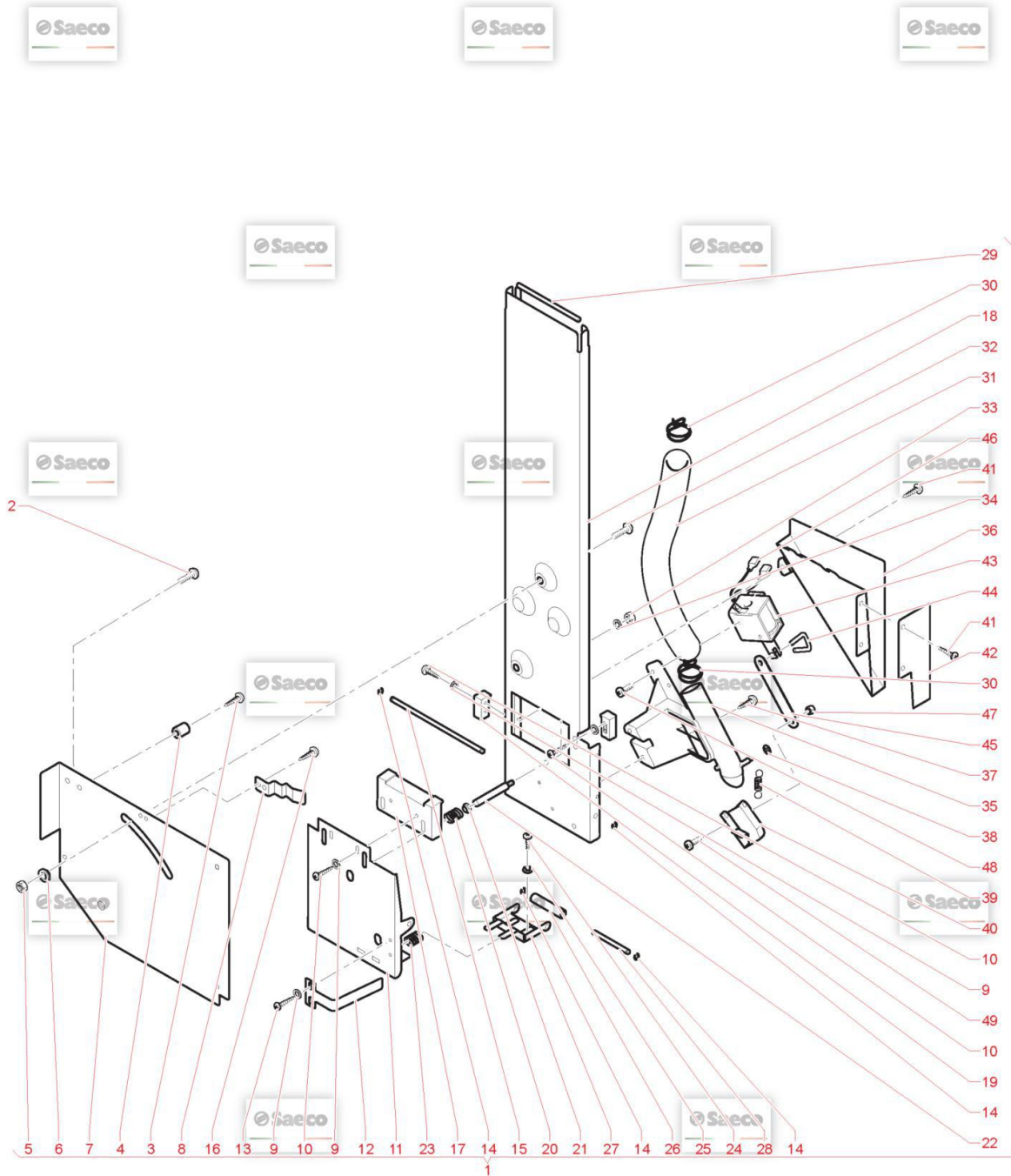

## Model Machine

MACSAE341

ВЕНДІНГ DIAMANTE RST BLK(10004840 )

Web Pos. Foto Item - Replace by Description



Press - CTRL + CLICK go to item in a new window











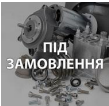

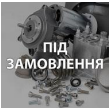













Натисніть - Ctrl + права кнопка миші щоб відкрити запчастину в новому вікні

	1		<b>11008243</b>	ASS. MODULE 3 MOTOR ASS. MODULE 3 MOTOR
	2		<b>11033505</b>	MOTOR MODULE CAPS MOTOR MODULE CAPS
	3		<b>9121.198.00A</b>	ВЕНТИЛЯТОР ВИТЯЖКИ 07 120X100X100 SAECO 9121.198.00A VENTILATORE CENTRIFUGO CAP 07
	4		<b>U109.005</b>	SCREW AUT.TCB 3,5X16 DIN 7981C VITE AUT.TCB 3,5X16 DIN 798
	5		<b>9111.640.060</b>	TUBE CONNECTOR TUBE CONNECTOR
	6		<b>0862.145</b>	SPIRAL TUBE L.210MM SPIRAL TUBE L.210MM
	7		<b>9111.718</b>	CLIP CLIP
	8		<b>11008244</b>	MODULE 3 MOTOR MODULE 3 MOTOR
	9		<b>U046.001</b>	SCREW TEFZ M5,0X16 UNI 6921 GALV. SCREW TEFZ M5,0X16 UNI 6921 GALV.
	10		<b>11008245</b>	ASPIRATION STEEL SHEET AT 3 ASPIRATION STEEL SHEET AT 3
	11		<b>U116.003</b>	SCREW AUT.PT TCB 3,0X12 WN 1441 VITE AUT.PT TCB 3,0X12 WN 1441 ZNP
	12		<b>11033372</b>	CRISTALLO400 CAPS PLATE CRISTALLO400 CAPS PLATE
	13		<b>129827502</b>	TCB SCREW M6X14 UNI 7687 ZNP TCB SCREW M6X14 UNI 7687 ZNP

## Model Machine

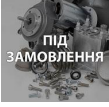
MACSAE341

ВЕНДІНГ DIAMANTE RST BLK(10004840 )

























	14		<b>11010959</b>	TUBE PVC OREGON D.32 L.170 <i>TUBE PVC OREGON D.32 L.170</i>
	15		<b>12002150</b>	HANDLE 37285 M.543/140 B-M6-C9 <i>HANDLE 37285 M.543/140 B-M6-C9</i>
	16		<b>U023.009</b>	SCREW TCEI M5,0X30 UNI 5931 8.8 B <i>SCREW TCEI M5,0X30 UNI 5931 8.8 B</i>
	17		<b>U116.004</b>	SCREW AUT.PT TCB 3,0X16 WN 1441 <i>SCREW AUT.PT TCB 3,0X16 WN 1441</i>
	18		<b>NE05.050</b>	MICROSWITCH <i>MICROSWITCH</i>
	19		<b>11031002</b>	CONVEYOR DUMP DISCHARGE <i>CONVEYOR DUMP DISCHARGE</i>
	20		<b>11033506</b>	COFFEE MODULE <i>COFFEE MODULE</i>
	21		<b>11001574</b>	FLANGE FIXING RATIONMOTOR LIP <i>FLANGIA FISSAGGIO MOTORIDUTTORI LIP</i>
	22		<b>WGADM1908</b>	SILICONE CUP <i>SILICONE CUP</i>
	23		<b>11033769</b>	SYPHON CRS400 EVO CAPS <i>SYPHON CRS400 EVO CAPS</i>
	24		<b>9972.195</b>	SILICONE TUBE 5X10 L.250MM <i>SILICONE TUBE 5X10 L.250MM</i>
	25		<b>11031225</b>	SPECIAL SEAL <i>SPECIAL SEAL</i>
	26		<b>U111.008</b>	NICK.SCREW AUT.TSP 3,5X9,5 DIN7982 C <i>NICK.SCREW AUT.TSP 3,5X9,5 DIN 7982 C</i>
	27		<b>11031007</b>	CONVEYOR DUMP <i>CONVEYOR DUMP</i>



## Model Machine

MACSAE341

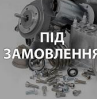









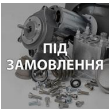







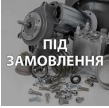

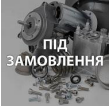





ВЕНДІНГ DIAMANTE RST BLK(10004840 )

	28		<b>U116.006</b>	SCREW AUT.PT TCB 3,5X12 WN 1441 ZNP VITE AUT.PT TCB 3,5X12 WN 1441 ZNP
	29		<b>0862.112</b>	GROUNDS SACK RING 8P КОЛЬЦО ANELLO SACCO FONDI 8P
	30		<b>11033509</b>	CONTAINER COUPLER CONTAINER COUPLER
	31		<b>U044.016</b>	SCREW TSP M4,0X16 UNI 7688 GALV. VITE TSP M4, 0X16 UNI 7688 ZNP
	32		<b>11033496</b>	SHEET METAL SUPPORT GROUP CAPS SHEET METAL SUPPORT GROUP CAPS
	33		<b>11033512</b>	SUPPORT PLATE FOR EXHAUSTED CAPS SUPPORT PLATE FOR EXHAUSTED CAPS
	34		<b>U127.005</b>	SCREW TAPT.TCB M4,0X8 DIN 7500C SCREW TAPT.TCB M4,0X8 DIN 7500C
	35		<b>12002032</b>	KNOB D.18 M5X40 VOLANTINO ZIGRINATO D.18 M5X40
	36		<b>U116.005</b>	SCREW AUT.PT TCB 3,0X8 WN 1441 VITE AUT.PT TCB 3,0X8 WN 1441 ZNP
	37		<b>11032241</b>	GRATE GRIGLIA X CONDOTTO CAPS
	38		<b>11032632</b>	COFFEE CONVEY CRS EVO CONVOGLIATORE FONDI CAPS CRS EVO
	39		<b>11033768</b>	SEAL SEAL
	40		<b>11033861</b>	CONVEYOR EXPIRE CAPSULS CRS EVO CONVEYOR EXPIRE CAPSULS CRS EVO

## Model Machine

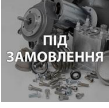
MACSAE341

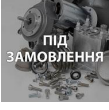



























ВЕНДІНГ DIAMANTE RST BLK(10004840 )

	41		11033202	NOZZLE ARM NOZZLE ARM
	42		11033186	SUPPORT NOZZLE ARM SUPPORT NOZZLE ARM
	43		9111.148	ELASTIC RING FOR FLOAT ANELLO ELASTICO X GALLEGGIANTE
	44		NE05.041	MICROSWITCH MICROINTERRUTTORE
	45		9111.775	CHAIN CHAIN
	46		9111.130	FLOAT FOR DISCHARGE LEVEL FLOAT FOR DISCHARGE LEVEL
	47		9111.147	COUNTERWEIGHT FOR FLOAT CONTRAPPESO X GALLEGGIANTE
	48		9111.722	PLATE PIASTRA SUPPORTO BRACCIO
	49		129670202	TCB PANELVIT SCREW 3,5X16 TESTA D=8 ZNP TCB PANELVIT SCREW 3,5X16 TESTA D=8 ZNP
	50		140321560	O-RING 3187 NBR OR 3187 IN NBR
	51		9111.710.A20	NOZZLE ARM BRACCIO GIREVOLE
	52		129512903	SCREW TCB PH-AB 2,9X13 UNI 6954 NI SCREW TCB PH-AB 2,9X13 UNI 6954 NI
	53		9111.719	PLATE PLATE
	54		U109.003	SCREW TCB 3,5X9,5 DIN 7981 C NICK SCREW TCB 3,5X9,5 DIN 7981 C NICK

## Model Machine

MACSAE341













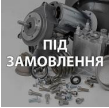



ВЕНДІНГ DIAMANTE RST BLK(10004840 )

	55		0875.150	RUBBER FOR DISPENSING COMP. <i>RUBBER FOR DISPENSING COMP.</i>
	56		11001454	PVC TUBE 16X22 L.350 MM <i>TUBO PVC 16X22 L.180MM</i>
	57		NV01.009	RUBBER BUFFER <i>GOMMINO PARACOLPI</i>
	58		9111.723	PLATE <i>PIASTRA X BRACCIO</i>
	59		U116.002	SCREW AUT.PT TCB 3,5X16 WN 1441 <i>SCREW AUT.PT TCB 3,5X16 WN 1441</i>
	60		U207.002	PLAIN WASHER 4,3X9 UNI 6592 GAL <i>ROSETTA PIANA 4,3X9 UNI 6592 ZNP</i>
	61		NE05.010	MICROSWITCH <i>MICROINTERRUPTORE</i>
	62		11033191	GEARMOTOR MECHTEX 25 RPM <i>MOTORIDUTTORE MECHTEX 25 RPM</i>
	63		9111.716.A20	CAM ARM <i>CAMMA BRACCIO</i>
	64		9111.715	CONNECTING ROD ARM <i>BIELLA BRACCIO</i>
	65		9111.204	BUSH FOR SPRING COMPENSATE STIRRER <i>BOCCOLA X MOLLA BILANCERE PALETTE</i>
	66		11033193	SPACER MOTOR ARM <i>SPACER MOTOR ARM</i>
	67		U043.015	SCREW TCBC M5,0X12 UNI 7687 GALV. <i>SCREW TCBC M5,0X12 UNI 7687 GALV.</i>
	68		11033514	SUPPORT PLATE FOR FAN CRISTALLO CAPS <i>SUPPORT PLATE FOR FAN CRISTALLO CAPS</i>

## Model Machine

MACSAE341

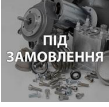
ВЕНДІНГ DIAMANTE RST BLK(10004840 )

	69		<b>U324.003</b>	NUT M5 FLANGED INDENTED BASE <i>NUT M5 FLANGED INDENTED BASE</i>
	70		<b>11033067</b>	PANEL FOR ORIENTATION FILTERS <i>PANEL FOR ORIENTATION FILTERS</i>
	71		<b>12002052</b>	ZN-B TCB SCREW M4X16 <i>ZN-B TCB SCREW M4X16</i>
	72		<b>0701.029.060</b>	APERTURE FOR ASPIRATION <i>APERTURE FOR ASPIRATION</i>
	73		<b>11033520</b>	BUSH X PLATE <i>BUSH X PLATE</i>
	74		<b>11033811</b>	BUSH FOR FAN <i>BUSH FOR FAN</i>
	75		<b>U044.013</b>	SCREW TSPC M4,0X12 UNI 7688 GALV. <i>VITE TSPC M4,0X12 UNI 7688 ZNP</i>
	76		<b>12002140</b>	CAP RBF-4.8-11.1-16 <i>CAP RBF-4.8-11.1-16</i>
	77		<b>U110.003</b>	SCREW AUT.TCB 3,5X9,5 DIN 7981F <i>VITE AUT.TCB 3,5X9,5 DIN 798</i>

# Model Machine

MACSAE341

ВЕНДИНГ DIAMANTE RST BLK(10004840 )

MACSAE341.T.0015

TAVOLA NR. 15 - ARTICOLO ВЕНДИНГ DIAMANTE RST BLK( 10004840 )

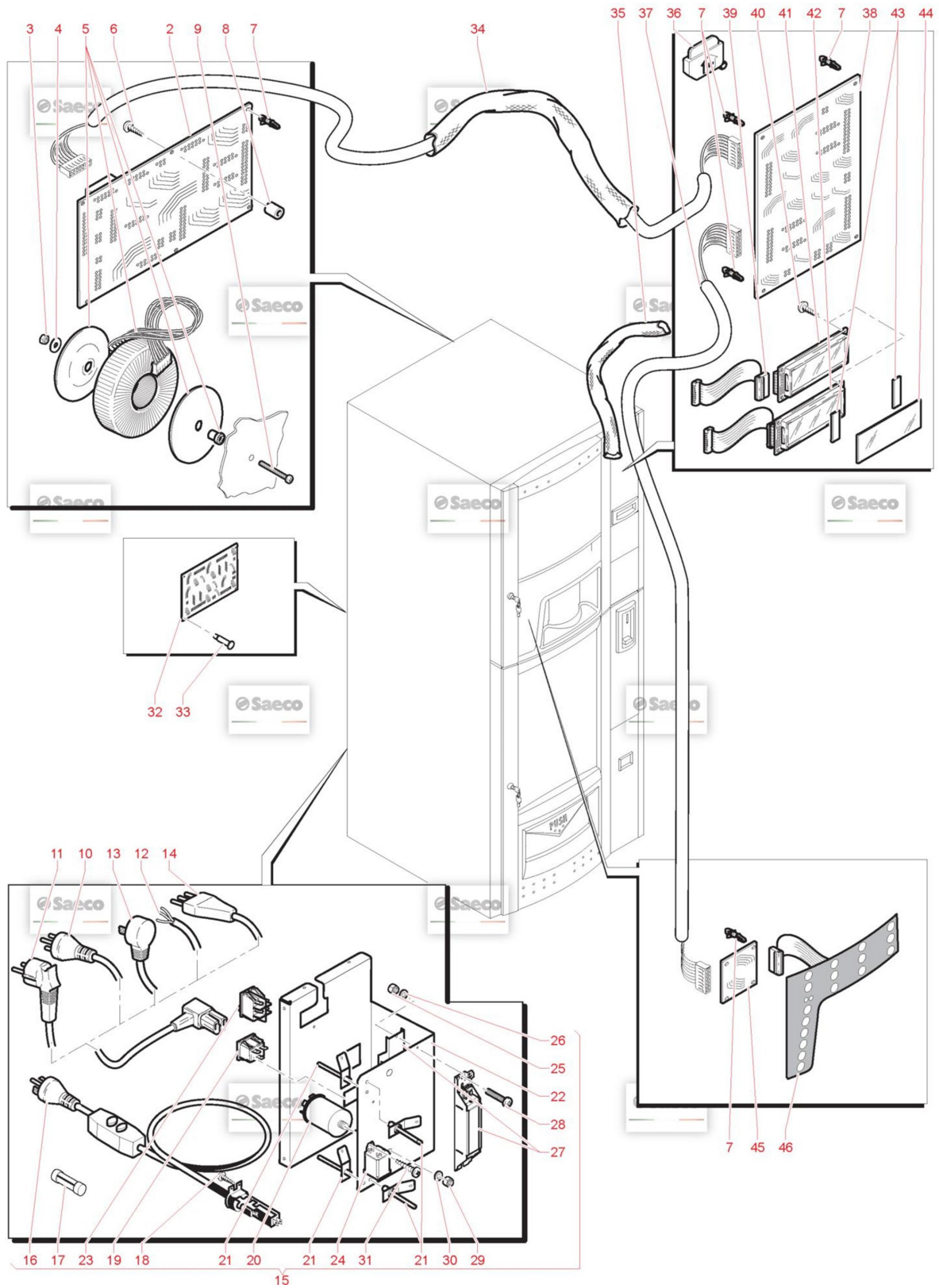

## Model Machine

MACSAE341

БЕНДІНГ DIAMANTE RST BLK(10004840 )

Web Pos. Foto Item - Replace by Description



Press - CTRL + CLICK go to item in a new window  
Натисніть - Ctrl + права кнопка миші щоб відкрити запчастину в новому вікні



1

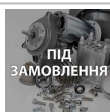

11032772

LOADER COMPLETE CAPS CL  
ASS.CARICATORE COMPLETO CAPS CL



1

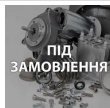

11033479

LOADER COMPLETE CAPS CC  
LOADER COMPLETE CAPS CC



1

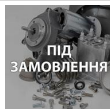

11034355

LOADER COMPLETE CAPS CO  
LOADER COMPLETE CAPS CO



2

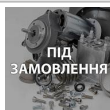

11032685

COVER CONTAINER  
COPERCHIO CONTENITORE EVO CAPS



3



11032682

CONTAINER  
CONTAINER



4



U116.006

SCREW AUT.PT TCB 3,5X12 WN 1441 ZNP  
VITE AUT.PT TCB 3,5X12 WN 1441 ZNP



5

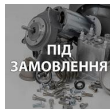

11033231

RATIOMOTOR GROUP CAPS  
ASS. MOTORIDUTTORE GRUPPO CAPS EVO



6



11002134

CARD 2 SENSOR RATIOMOTOR  
CARD 2 SENSOR RATIOMOTOR



7



U207.002

PLAIN WASHER 4,3X9 UNI 6592 GAL  
ROSETTA PIANA 4,3X9 UNI 6592 ZNP



8



U005.010

SCREW TE M4,0X14 UNI 5739 GALV.  
SCREW TE M4,0X14 UNI 5739 GALV.



9

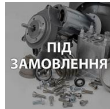

11002211

CARD PROTECTION RATIOMOTOR  
CARD PROTECTION RATIOMOTOR



10

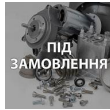

11031224

CAM  
CAM



11

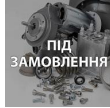











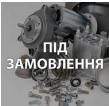

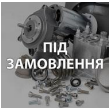













U005.012

SCREW TE M4,0X30 UNI 5739 GALV.  
SCREW TE M4,0X30 UNI 5739 GALV.

## Model Machine

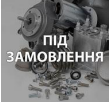
MACSAE341

















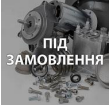





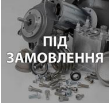

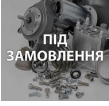
ВЕНДІНГ DIAMANTE RST BLK(10004840 )

	12		<b>11002964</b>	SPACE FOR CENTRAL CARD 2 SENSORY <i>SPACE FOR CENTRAL CARD 2 SENSORY</i>
	13		<b>NL04.014</b>	SPACER CARD H=9,5 <i>SPACER CARD H=9,5</i>
	14		<b>120340804</b>	EL. SHAFT RETAIN.RING D=8 UNI7435 <i>EL. SHAFT RETAIN.RING D=8 UNI 7435</i>
	15		<b>12000232</b>	LIP RATIO MOTOR ST.112B 24VDC 11RPM <i>LIP RATIO MOTOR ST.112B 24VDC 11RPM</i>
	16		<b>11002133</b>	JOINT WITH SHAFT FOR RATIO MOTOR <i>JOINT WITH SHAFT FOR RATIO MOTOR</i>
	17		<b>11033219</b>	SUPPORT PLATE MOTOR <i>SUPPORT PLATE MOTOR</i>
	18		<b>128310404</b>	МЕТАЛЕВЕ УБЧАСТЕ КОЛІЩАТКО UNI 8842 A4 <i>WASHER UNI 8842 A4 BURNISHED</i>
	19		<b>129824002</b>	TCB SCREW M4X10 UNI 7687 ZNP <i>VITE TCB M4X10 UNI 7687 ZNP</i>
	20		<b>U407.001</b>	ELASTIC PIN 3,0X20 UNI 6874 <i>ELASTIC PIN 3,0X20 UNI 6874</i>
	21		<b>129825002</b>	TCB SCREW M4X20 UNI 7687 ZNP <i>TCB SCREW M4X20 UNI 7687 ZNP</i>
	22		<b>12001926</b>	CABLE CLAMP SCREW FASTENING 6571 AA00 <i>CABLE CLAMP SCREW FASTENING 6571 AA00</i>
	23		<b>11031030</b>	SPECIAL SPRING <i>MOLLA AGITATORE CAPS</i>
	24		<b>11032145</b>	ROTORE CAPS <i>ROTORE CAPS</i>
	24		<b>11032373</b>	ROTORE CAPS CA <i>ROTORE CAPS CA</i>

## Model Machine

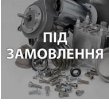
MACSAE341

БЕНДІНГ DIAMANTE RST BLK(10004840 )

	24		11034281	ROTORE CAPS COVIM <i>ROTORE CAPS COVIM</i>
	25		129720102	TE SCREW M4X20 UNI 5739 ZNP <i>TE SCREW M4X20 UNI 5739 ZNP</i>
	26		11031024	SAFETY LEVER CAPS <i>LEVA SICUREZZA CAPS</i>
	27		NV01.006	ADHESIVE FOOT <i>ADHESIVE FOOT</i>
	28		9111.397	SPRING FOR TRAY /LEVER COIN RECOVE <i>MOLLA X BACINELLA/LEVA RECUP</i>
	29		U142.008	PANELVIT TSP 3,5X12 DIN 7505 AGAL <i>PANELVIT TSP 3,5X12 DIN 7505 A GAL</i>
	30		U140.017	PANELVIT TCB 3,0X20 DIN 7505 BGAL <i>PANELVIT TCB 3,0X20 DIN 7505 B GAL</i>
	31		11032699	SUPPORT EXTERNAL ROTOR <i>SUPPORT EXTERNAL ROTOR</i>
	32		U324.006	ШАЙБА M4 <i>NUT M4 FLANGED INDENTED BASE</i>
	33		11008644	LOCK PIN <i>LOCK PIN</i>
	34		12002031	KNOB D.18 M5X15 <i>KNOB D.18 M5X15</i>
	35		15004268	ADHESIVE HEIGHT CAPSULE CAFFITALY <i>ADHESIVE HEIGHT CAPSULE CAFFITALY</i>
	36		11032710	SUPPORT SHEET METAL CAPS <i>SUPPORT SHEET METAL CAPS</i>



## Model Machine

MACSAE341

ВЕНДІНГ DIAMANTE RST BLK(10004840 )

	37		11031027	SUPPORTO ESTERNO ROTORE CAPS <i>SUPPORTO ESTERNO ROTORE CAPS</i>
	38		11031752	RATIOMOTOR 24V CAPS <i>RATIOMOTOR 24V CAPS</i>
	39		U207.004	PLAIN WASHER 4,3X16 UNI 6592 GAL <i>PLAIN WASHER 4,3X16 UNI 6592 GAL</i>
	40		NE17.013	CABLE RETAINER <i>CABLE RETAINER</i>
	41		11032533	ROTATION PIN <i>ROTATION PIN</i>
	42		U110.002	SCREW AUT.TCB 3,5X13 DIN 7981F <i>SCREW AUT.TCB 3,5X13 DIN 7981 F</i>
	43		11032534	SUPPORT CHANNEL LOADER <i>SUPPORTO CANALE CARICATORE</i>
	44		11031025	STIRRER DRAIN COVER <i>STIRRER DRAIN COVER</i>
	45		11031062	RATIOMOTOR 24V CAPS <i>RATIOMOTOR 24V CAPS</i>
	46		11031022	CHANNEL CONVEYOR CAPS <i>CHANNEL CONVEYOR CAPS</i>
	46		11032638	CHANNEL CONVEYOR CAPS CA <i>CHANNEL CONVEYOR CAPS CA</i>
	47		11031021	SWITCH CHANNEL CONVEYOR <i>SWITCH CHANNEL CONVEYOR</i>
	48		11031023	COVER CONVEYOR CAPS <i>COVER CONVEYOR CAPS</i>
	49		11031026	STIRRER DRAIN CAPS <i>STIRRER DRAIN CAPS</i>

## Model Machine

MACSAE341

БЕНДИНГ DIAMANTE RST BLK(10004840 )



50



U043.015

SCREW TCBC M5,0X12 UNI 7687 GALV.

*SCREW TCBC M5,0X12 UNI 7687 GALV.*



51

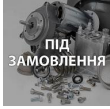

11032683

EXTENSION FOR CONTAINER

*EXTENSION FOR CONTAINER*

# Model Machine

MACSAE341

ВЕНДИНГ DIAMANTE RST BLK(10004840 )

MACSAE341.T.0016



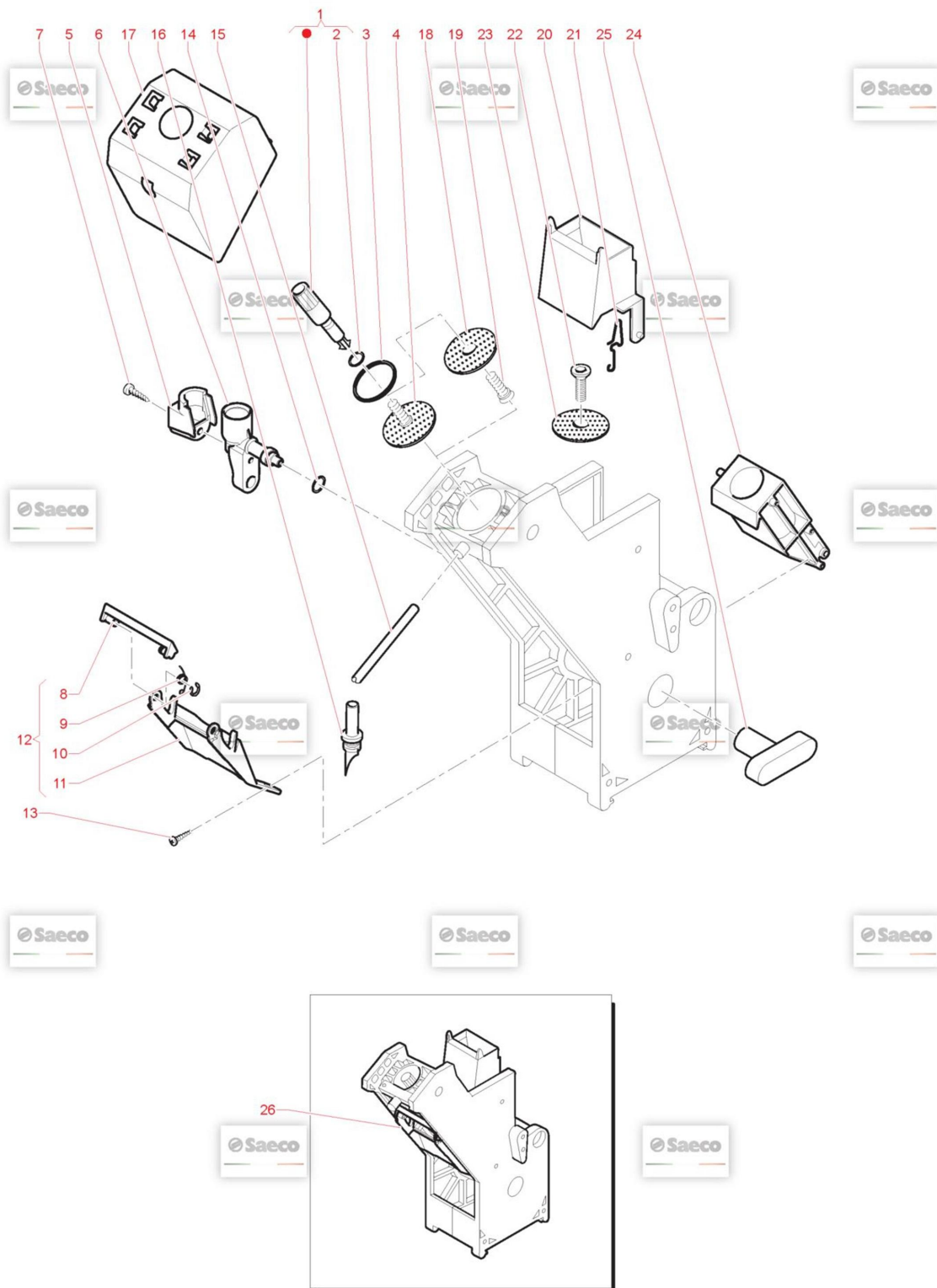























TAVOLA NR. 16 - ARTICOLO ВЕНДИНГ DIAMANTE RST BLK( 10004840 )



## Model Machine

MACSAE341





























ВЕНДІНГ DIAMANTE RST BLK(10004840 )

Web	Pos.	Foto	Item - Replace by	Description
				<i>Press - CTRL + CLICK go to item in a new window Натисніть - Ctrl + права кнопка миші щоб відкрити запчастину в новому вікні</i>
	1		1863.A10	ASS.MIXER FS400 ASS.MIXER A SPIRALE FS400
	2		9972.057	КОРИЧНЕВА ГУМОВА ТРУБКА 5X8 2 МЕТРИ TUBO SILICONE MARRON 5X8 L.2000 MM
	3		U116.005	SCREW AUT.PT TCB 3,0X8 WN 1441 VITE AUT.PT TCB 3,0X8 WN 1441 ZNP
	4		U207.004	PLAIN WASHER 4,3X16 UNI 6592 GAL PLAIN WASHER 4,3X16 UNI 6592 GAL
	5		9111.209.060	CURSOR FOR SPIRAL MIXER FIXING CURSOR FOR SPIRAL MIXER FIXING
	6		9111.211	SPRING FOR MIXER CURSOR MOLLA X CURSORE MISCELATORE
	7		9111.643.060	RAPID FIXING MIXER RAPID FIXING MIXER
	8		9111.010.060	LID FOR FUNNEL BROWN COPERCHIO X IMBUTO MARRON
	9		9111.011.060	SEAL FOR FUNNEL BROWN GUARNIZIONE X IMBUTO MARRON
	10		9111.009.060	FUNNEL FOR POWDERS BROWN IMBUTO X POLVERI MARRON
	11		1863.A07	ESPRESSO NOZZLE ASS.UGELLO ESPRESSO
	12		9111.771.270	MOTOR COUPLING ORANGE RAL MOTOR COUPLING ORANGE RAL
	13		9121.248.00P	MOTOP MIKCEPA '05 24V DC - M.B.T. COD. 912124800 SAECO 9121.248.00 MOTORE MIXER '05 24V DC - M.B.T.

## Model Machine

MACSAE341

























ВЕНДІНГ DIAMANTE RST BLK(10004840 )

	14		9111.773.060	MOTOR PROTECTION RING <i>ANELLO PROTEZIONE MOTORE MIXER '05</i>
	15		9972.055	ТРУБКА СИЛІКОНОВА 8X12 2 МЕТРИ <i>SILICONE TUBE 8X12 L.2000MM</i>
	16		NV99.072	HOSE CLAMP D. 11.6/12.3 <i>HOSE CLAMP D. 11.6/12.3</i>
	17		9111.349	ELBOW DISPENSING NOZZLE <i>UGELLO EROGAZIONE GOMITO</i>
	18		U116.006	SCREW AUT.PT TCB 3,5X12 WN 1441 ZNP <i>VITE AUT.PT TCB 3,5X12 WN 1441 ZNP</i>
	19		9111.769.150	MIXER FLANGE <i>MIXER FLANGE</i>
	20		9111.770.060	COVER MIXER FLANGE <i>COVER MIXER FLANGE</i>
	21		NM03.012	OR ORM 0320-25 NBR <i>OR ORM 0320-25 NBR</i>
	22		9111.772.060	DISK FAN <i>VENTOLINA A DISCO MIXER '05</i>
	23		NM05.015	ПРОКЛАДКА V-RING 405 МІКСЕРА ДЛЯ КАВОМАШИН SAECO <i>V-RING MIXER '05</i>
	24		9110.160.06P	ДВИГУН МІКСЕРА ДЛЯ КАВОМАШИНИ SAECO 05 24V DC SAECO 9110.1... <i>ASS.MIXER '05 24V DC GROUP 500 SAECO</i>
	25		9111.230.270	MIXER LOCKING RING NUT ORANGERAL <i>GHIERA BLOCCAGGIO MIXER ARANCIO RAL</i>
	26		9111.227.060	MIXER CASING <i>CORPO MIXER</i>
	27		9110.027.060	MIX CASING ASS. <i>ASS.CORPO MIX SAECO CRISTALLO,ATLANTE,QUARZO,RUBINO</i>

## Model Machine

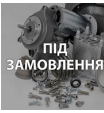
MACSAE341

ВЕНДІНГ DIAMANTE RST BLK(10004840 )

	28		9111.232.060	STD TUBE HOLDER SLEEVE <i>MANICOTTO PORTATUBO STANDARD</i>
	28		9111.233.060	DECAFF.TUBE HOLDER SLEEVE <i>MANICOTTO PORTATUBO DECAFFEINATO</i>
	29		11025295	TEFLON TUBE 3X6 L.170 1/8"-1/8 <i>TEFLON TUBE 3X6 L.170 1/8-1/8</i>
	30		9991.059	STRAIGHT BICONE CONNECTOR M 1/8X06 <i>STRAIGHT BICONE CONNECTOR M 1/8X06</i>
	31		129516803	SCREW TCB3,5X19 DIN 7981 NICK <i>SCREW TCB3,5X19 DIN 7981 NICK</i>
	32		20005373	SOLENOID X HS1 11023762 <i>SOLENOID X OLAB 24V DC 6000BH/BODN</i>
	33		12001169	ЛАТУННА ЗАГЛУШКА BRASS CAP 1/8 GAS CONICAL TEA <i>BRASS CAP 1/8 GAS CONICAL TEA</i>
	34		11011470	BLOCK 4 ELECTROVALVE DC OLAB TEA <i>BLOCK 4 ELECTROVALVE DC OLAB TEA</i>
	35		NM01.004	OR 2025 SILICONE <i>OR 2025 SILICONE</i>
	36		11011453	RUBBER HOLDER CONNECTOR TEA <i>RUBBER HOLDER CONNECTOR TEA</i>
	37	 ПІД ЗАМОВЛЕННЯ	11033756	ELECTROVALVE SUPPORT <i>ELECTROVALVE SUPPORT</i>
	38		20005374	ASS.NUCLEO FIS+MOB.X 11009225 <i>ASS.NUCLEUS 6000BH/BODN X 11009225</i>
	39		20007305	ЧАСТИНА ЕЛЕКТРОМАГНІТНОГО КЛАПАНА З ПОДВИЖНИМ СЕРДЕЧНИК... <i>SPARE EV MOBILE CORE 11023762</i>

## Model Machine

MACSAE341

ВЕНДІНГ DIAMANTE RST BLK(10004840 )



40

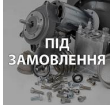

9972.246

СИЛІКОНОВА ТРУБКА 5X10 SAECO 265918 (2 МЕТРИ)

*TUBO SILICONE 5X10 L.2000 MM*

---

# Model Machine

MACSAE341

ВЕНДІНГ DIAMANTE RST BLK(10004840 )

MACSAE341.T.0017

TAVOLA NR. 17 - ARTICOLO ВЕНДІНГ DIAMANTE RST BLK( 10004840 )

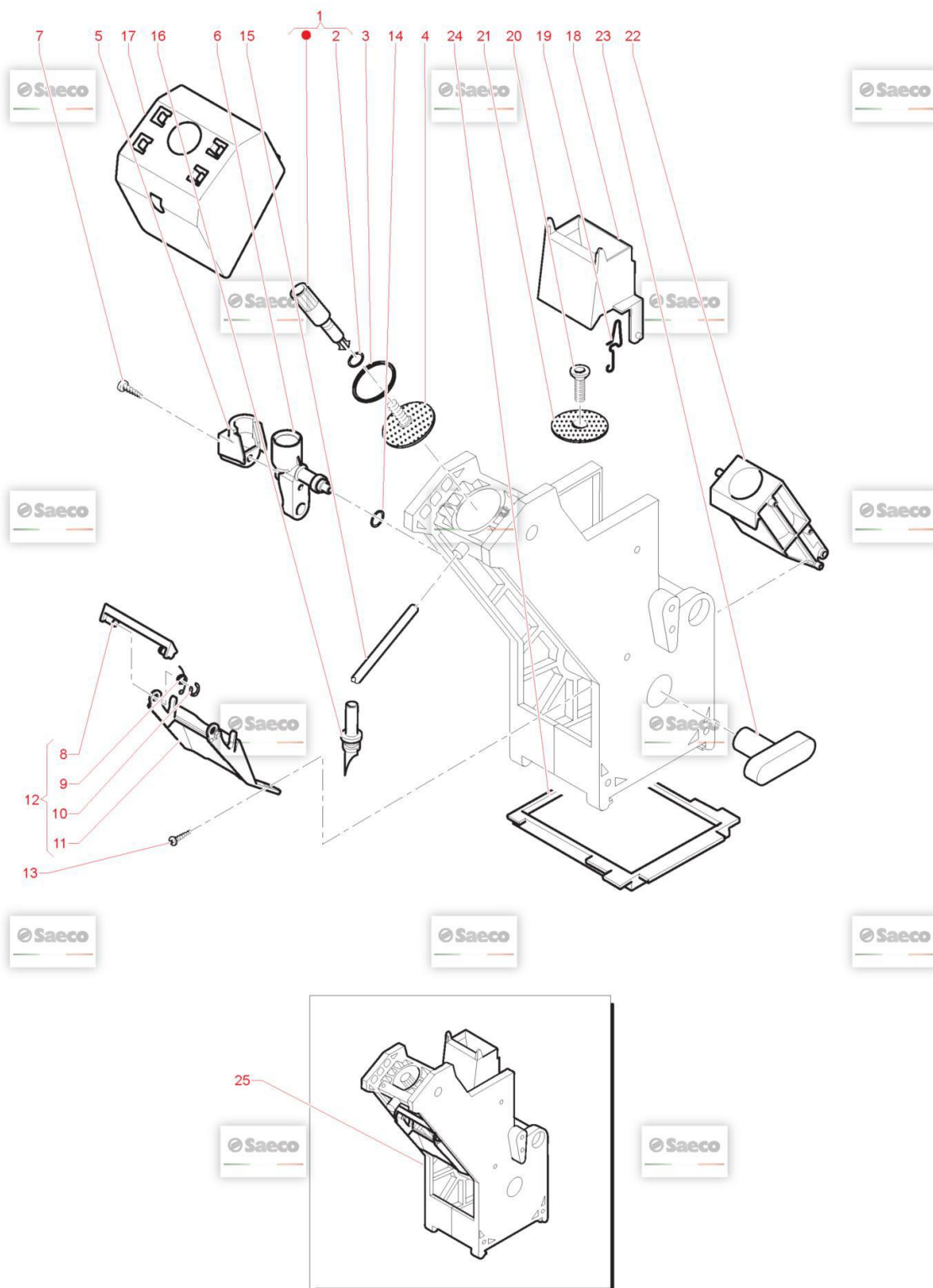



## Model Machine

MACSAE341

БЕНДІНГ DIAMANTE RST BLK(10004840 )

Web Pos. Foto Item - Replace by Description



Press - CTRL + CLICK go to item in a new window

Натисніть - Ctrl + права кнопка миші щоб відкрити запчастину в новому вікні



1

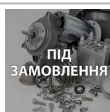

11033852

FLAT 24P PW BOARD / CAPS BOARD CRS EVO  
FLAT 24P SCHEDA PW/SCHEDA CAPS CRS EVO



2



1863.604

HARNESS  
FLAT CABLE



3



1863.636

POWER CARD FS400  
SCHEDA POWER FS400



4



9111.402

SPACER FOR CARD  
SPACER FOR CARD



5

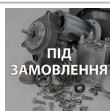

11033853

FLAT 24P EXTENSION CAPS BOARD CRS EVO  
FLAT 24P EXTENSION CAPS BOARD CRS EVO



6

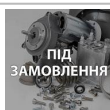

11033815

CAPSULE POWER BOARD  
CAPSULE POWER BOARD



7

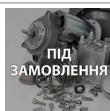

11033896

FLAT CABLE EXTEND CPU/IO CRS600 EVO  
FLAT CABLE EXTEND CPU/IO CRS600 EVO



8

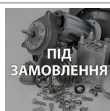

1863.070

BOX  
BOX



9



11001619

CABLE TUBE L.520 MM  
GUAINA X CAVI L.520 MM



10



U109.003

SCREW TCB 3,5X9,5 DIN 7981 C NICK  
SCREW TCB 3,5X9,5 DIN 7981 C NICK



11

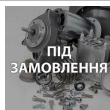

11011054

PIN FOR BOSS D.8  
PIN FOR BOSS D.8



12



U110.005

SCREW AUT.TCB 3,9X9,5 DIN 7981F  
VITE AUT.TCB 3,9X9,5 DIN 798



13































U207.013

PLAIN WASHER 6.5X18 UNI 6592 GALV  
PLAIN WASHER 6.5X18 UNI 6592 GALV

## Model Machine

MACSAE341

















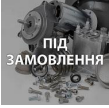





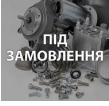

ВЕНДІНГ DIAMANTE RST BLK(10004840 )

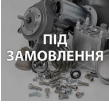
	14		<b>U310.004</b>	NUT SELF LOCK.M6 UNI 7473 <i>NUT SELF LOCK.M6 UNI 7473</i>
	15		<b>NE01.050</b>	CABLE SCHUKO WITH PLUG EN60320C1 <i>CAVO SCHUKO CON SPINA EN60320 C13</i>
	16		<b>11032399</b>	3,5" TFT DISPLAY 320X240 <i>3,5 TFT DISPLAY 320X240</i>
	17		<b>NE01.053</b>	CABLE AUSTRAL. +PLUG EN60320 C13 <i>CABLE AUSTRAL. +PLUG EN60320 C13</i>
	17		<b>NE01.093</b>	CABLE ARGENTINA + PLUG EN60320C13 <i>CABLE ARGENTINA + PLUG EN60320 C13</i>
	18		<b>17800019</b>	BLACK POWER CABLE BRAZIL L=1200 <i>BLACK POWER CABLE BRAZIL L=1200</i>
	18		<b>NE01.051</b>	CABLE SWITZERLAND WITH PLUG EN603 <i>CABLE SWITZERLAND WITH PLUG EN603</i>
	19		<b>11003906</b>	USA CABLE SUPPORT ELECTRONIC PARTS BOX <i>USA CABLE SUPPORT ELECTRONIC PARTS BOX</i>
	20		<b>11012009</b>	POWER CABLE USA 3 POLE 15A X GFC8 <i>POWER CABLE USA 3 POLE 15A X GFC8</i>
	21		<b>U208.003</b>	TOOTHED WASHER 5,1X9 BRU <i>TOOTHED WASHER 5,1X9 BRU</i>
	22		<b>U302.003</b>	МЕТАЛЕВА ГАЙКА M4 UNI 5588 ZNP <i>DADO ESAGONALE M4 UNI 5588 ZNP</i>
	23		<b>11000546</b>	POWER CONNECTOR SUPPORT <i>SQUADRETTA X PRESA VASCHETTA</i>
	24		<b>187850400</b>	TRIPOLE SOCKET SELF-LOCKING <i>TRIPOLE SOCKET SELF-LOCKING</i>
	25		<b>U110.003</b>	SCREW AUT.TCB 3,5X9,5 DIN 7981F <i>VITE AUT.TCB 3,5X9,5 DIN 798</i>

## Model Machine

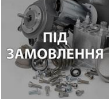
MACSAE341













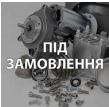

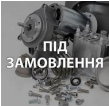











ВЕНДІНГ DIAMANTE RST BLK(10004840 )

	26		11012747	CARD PROTECTION LED ATLANTE <i>CARD PROTECTION LED ATLANTE</i>
	27		NE19.023	TOROIDAL TRANSFORMER COMBI 240V <i>TOROIDAL TRANSFORMER COMBI 240V</i>
	27		NE19.028	TOROIDAL TRANSFORMER FS 400 <i>TRASFORMATORE TOROIDALE FS 400</i>
	28		1863.045	ASPIRATION CASING FOR MIXER <i>ASPIRATION CASING FOR MIXER</i>
	29		U302.007	NUT HEXAGONAL M8 UNI 5588 <i>NUT HEXAGONAL M8 UNI 5588</i>
	30		U208.009	TOOTHED WASHER 8,4X15 UNI 3703 <i>TOOTHED WASHER 8,4X15 UNI 3703</i>
	31		NE13.016	FUSE HOLDER WITH SCREW ON CAP <i>PORTAFUSIBILE CON TAPPO A VITE</i>
	32		U005.013	SCREW TE M6,0X70 UNI 5739 GALV. <i>SCREW TE M6,0X70 UNI 5739 GALV.</i>
	33		184651500	LOCKING SCREW ANTIDISTURB FILTER 16A <i>LOCKING SCREW ANTIDISTURB FILTER 16A</i>
	34		11030270	ATLANTE LED POWER SUPPLY <i>ATLANTE LED POWER SUPPLY</i>
	35		11003867	SAFETY PLATE FOR EL.BOX CONNECTOR <i>SAFETY PLATE FOR EL.BOX CONNECTOR</i>
	36		NE13.002	FUSE 6,3X32 8A 250V DELAYED <i>FUSE 6,3X32 8A 250V DELAYED</i>
	36		NE13.081	FUSE 6,3X32 16A 250V DELAYED UL <i>FUSIBILE 6,3 X 32 15A 250V RITARD UL SOLO UL</i>

## Model Machine

MACSAE341

ВЕНДІНГ DIAMANTE RST BLK(10004840 )

	37		12002039	SCREW TCBD TORX 20 M4X12 ZN-B VITE TCBD TORX 20 M4X12 ZN-B
	38		11033879	CABLE TUBE L.650MM CABLE TUBE L.650MM
	39		0875.990	TOUCH PANEL PLATE TOUCH PANEL PLATE
	40		0875.741	TOUCH PANEL TOUCH PANEL
	41		11033307	AS.CPU+SW CRISTALLO EVO AS.CPU+SW CRISTALLO EVO
	42		11033778	HARNESS CPU BOARD KEYBOARD CAPACITIVE HARNESS CPU BOARD KEYBOARD CAPACITIVE
	43		U116.005	SCREW AUT.PT TCB 3,0X8 WN 1441 VITE AUT.PT TCB 3,0X8 WN 1441 ZNP
	44		9991.140.050	IMPULSECOUNTERHOLDER KEISU GX-06R PORTA CONTAIMPULSI KEISU GX-
	45		NE13.025.00P	IMPULSE COUNTER KEISU GX-06R 24V CONTAIMPULSI KEISU GX-06R 24
	46		11032875	ILLUMINATOR 16+3 LED FS4N ILLUMINATOR 16+3 LED FS4N
	47		11032383	HW INTERF. NEW TFT DISPLAY UMSH-8252MD-T SCHEMA INTERF. DISPLAY TFT UMS H-8252MD-T CRISTALLO400/600/PHE...
	48		11032885	SCHEMA LEDS CAPACITIVA SCHEMA LEDS CAPACITIVA
	49		U116.006	SCREW AUT.PT TCB 3,5X12 WN 1441 ZNP VITE AUT.PT TCB 3,5X12 WN 1441 ZNP
	50		11032820	DISPLAY / LED SUPPORT FS4N DISPLAY / LED SUPPORT FS4N

## Model Machine

MACSAE341

БЕНДИНГ DIAMANTE RST BLK(10004840 )



51

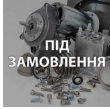

11032991

CAPACITIVE ADHESIVE CIRCUIT 19KEYS

*CAPACITIVE ADHESIVE CIRCUIT 19 KEYS*

# Model Machine

MACSAE341

ВЕНДИНГ DIAMANTE RST BLK(10004840 )

MACSAE341.T.0018

TAVOLA NR. 18 - ARTICOLO ВЕНДИНГ DIAMANTE RST BLK( 10004840 )

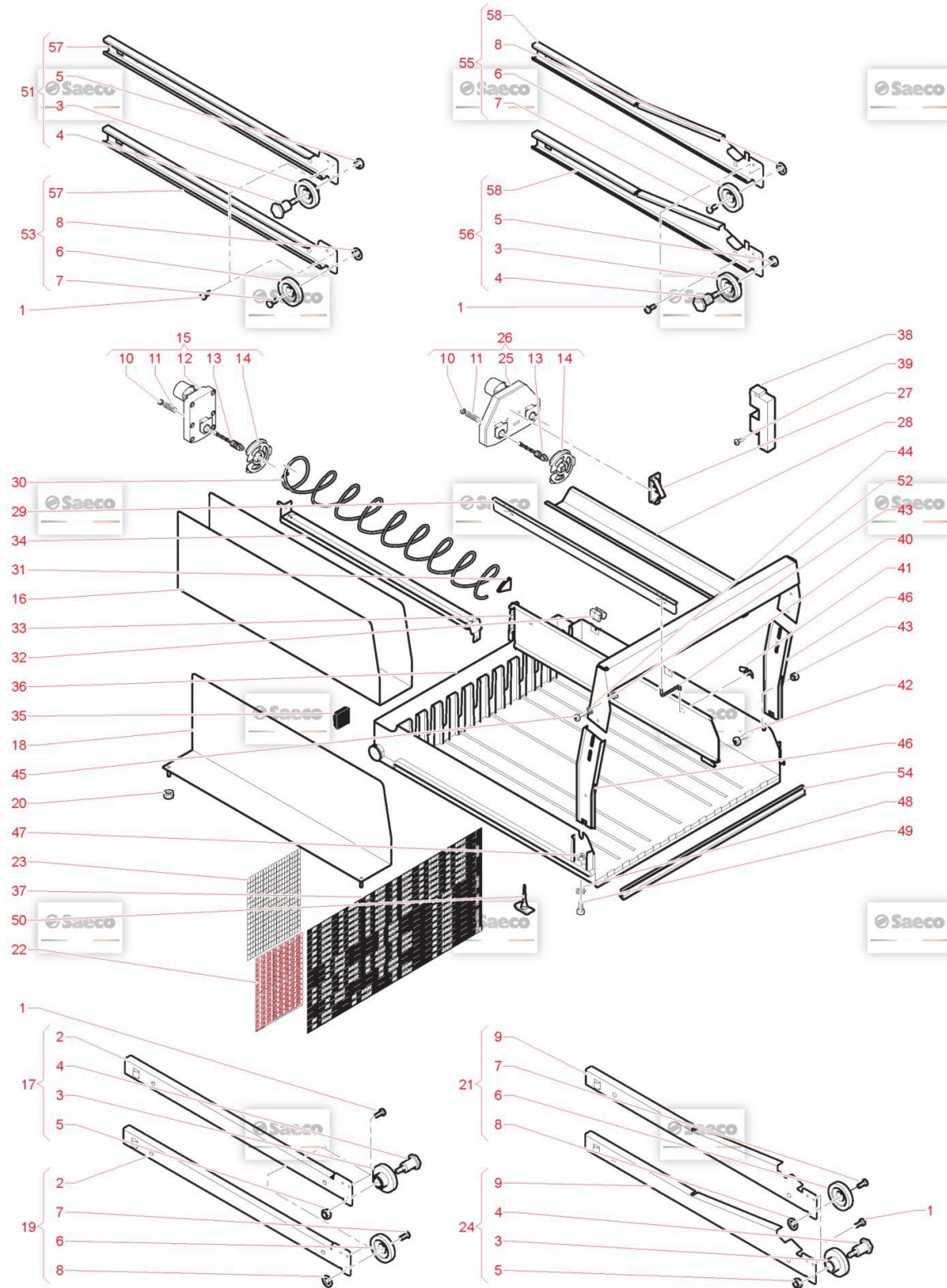

## Model Machine

MACSAE341

ВЕНДІНГ DIAMANTE RST BLK(10004840 )

Web Pos. Foto Item - Replace by Description



Press - CTRL + CLICK go to item in a new window

Натисніть - Ctrl + права кнопка миші щоб відкрити запчастину в новому вікні



1



11030408

BREWING UNIT ASS. 7GR GRAN GUSTO  
ASS. GRUPPO CAFFE 6/8GR NEW



2



11029737

PROTECTION VALVE  
PROTEZIONE VALVOLA SFIATO GRUPPO CAFFE



3



11029311

COVER BALL VALVE  
COPERCHIO VALVOLA SFERA



4

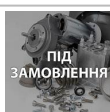

9972.345

SILICONE TUBE 3,5X9 L.340MM  
SILICONE TUBE 3,5X9 L.340MM



5

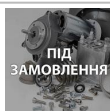

11033574

COFFEE NOZZLES  
COFFEE NOZZLES



6



11030836

ШПЛИНТ ФІКСАЦІЇ СУППОРТУ КЛАПАНА  
PIN FIXING VALVE SUPPORT



7



11029312

BREATHER VALVE CLOSED  
CHIUSURA VALVOLA SFIATO



8



NV01.009

RUBBER BUFFER  
GOMMINO PARACOLPI



9



9161.320

VALVE FOR UNIT  
VALVOLA X GRUPPO CAFFE'



10

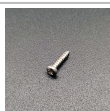

U109.006

SCREW AUT.TCB 2,2X9,5 DIN 7981C  
VITE AUT.TCB 2,2X9,5 DIN 7981 C NIK



11



126771918

SS COFFEE UNIT CONTERPISTON SPRING SMART  
MOLLA CONTROPIST. GRUP. SMART INOX



12



12001811

SPHERE TEFLON D.4,5  
SFETA D.4.5 TEFLON X VALVOLA GRUPPO CAFF



13































11029317

NUT SEAL PISTON MOVABLE  
DADO TENUTA CONTROPISTONE MOBILE

## Model Machine

MACSAE341

ВЕНДІНГ DIAMANTE RST BLK(10004840 )



























	14		11029316	FLANGE FOR CUPHOLDER <i>FLANGIA X PISTONE MOBILE</i>
	15		11029308	SPRING FOR MOVABLE COUNTERPISTON <i>MOLLA X CONTROPISTONE MOBILE</i>
	16		129512921	SCREW TCB TORX 10 AB 2,9X13 SHEET SS <i>SCREW TCB TORX 10 2,9X13 SHEET SS</i>
	17		11010013	CARTER FOR MUFF PREHEATING UNIT <i>CARTE X MANICOTTO GRUPPO PRERISCALDO</i>
	18		11005371	UNIT COFFEE MUFF <i>MANICOTTO GRUPPO CAFFE' UNIT COFFEE MUFF</i>
	19		9111.537.060	BROWN SCRAPER COFFEE GROUP <i>BROWN SCRAPER COFFEE GROUP</i>
	20		9111.520	SPRING FOR SCRAPER SECTION 0.6 <i>SPRING FOR SCRAPER SECTION 0.6</i>
	21		U701.006	ФІКСУЮЧА СКОБА 3,2 (ЗАПІЗО) SAECO <i>ANELLO ELASTICO 3,2</i>
	22		9111.539.060	FORK FOR SCRAPER <i>FORCELLA PER RASCHIATORE</i>
	23		9110.067.060	SCRAPER ASS.FOR CAPPUCINAT. TUBE <i>ASS.RASCHIATORE X SG500/700</i>
	24		U110.013	БОЛТ МЕТАЛЕВИЙ 3,9X6,5 DIN 7981 F <i>SCREW AUT.TCB 3,9X6,5 DIN 7981 F</i>
	25		11030309	RING FOR CAM <i>ANELLO X CAMMA PISTONE</i>
	26		11029313	CURSOR COMPENSATOR VALVE VENT <i>CURSORE COMPENSATORE X VALVOLA SFIATO</i>
	27		U701.007	ЕЛАСТИЧНЕ КІЛЬЦЕ 6 UNI 7434 (ЗАПІЗО) <i>ЕЛАСТИЧНЕ КІЛЬЦЕ 6 UNI 7434 (ЗАПІЗО)</i>



## Model Machine

MACSAE341







БЕНДИНГ DIAMANTE RST BLK(10004840 )

	28		11029310	SPRING FOR RELIEF VALVE <i>MOLLA COMPENSATRICE X VALVOLA SFIATO</i>
	29		11029314	CURSOR FOR VALVE VENT <i>CURSORE X VALVOLA SFIATO</i>
	30		11029309	SPRING FOR RELIEF VALVE <i>MOLLA X VALVOLA SFIATO</i>
	31		140322061	O-RING 4112 EPDM <i>OR 4112 IN EPDM</i>
	32		11012630	PERCOLATOR D.34 <i>PERCOLATOR D.34</i>
	33		U044.009	SS SCREW TSPC M3,0X8 UNI 7688 <i>VITE TSCP M3,0X8 UNI 7688 INO</i>
	34		140321462	O-RING 2018 SILICONE <i>OR 2018 IN SILICONE</i>
	35		322001201	MOBILE SCRAPER BROWN NARROW <i>MOBILE SCRAPER BROWN NARROW</i>
	36		9161.425	SPRING FOR SCRAPER <i>SPRING FOR SCRAPER</i>
	37		129851921	TSP SCREW M3X6 UNI 7688 SS <i>TSP SCREW M3X6 UNI 7688 SS</i>
	38	 ПІД ЗАМОВЛЕННЯ	324000200	SS PERCOLATOR D=34 FOR UNIT <i>SS PERCOLATOR D=34 FOR UNIT</i>
	39		222711101	BROWN GROUND COFF.CONTAINER D=36 ASSY. <i>BROWN GROUND COFF.CONTAINER D=36 ASSY.</i>
	40		9161.021.060	KEY FOR BREW UNIT BROWN <i>CHIAVE X GRUPPO CAFFE' MARRO</i>

## Model Machine

MACSAE341

ВЕНДІНГ DIAMANTE RST BLK(10004840 )

	41		11012957	SCRAPER FOR COFFEE UNIT 7-9GR. <i>SCRAPER FOR COFFEE UNIT 7-9GR.</i>
	42		11030122	SPACE <i>SPACE</i>
	43		NM01.029	OR ORM 0100-15 SILICONE <i>OR ORM 0100-15 SILICONE</i>
	44		11029878	ASS.CONTROPISTONE MOBILE <i>ASS.CONTROPISTONE MOBILE</i>
	45		140322500	ПРОКЛАДКА O-RING 2118 SH70 BIANCHI 36363116-01, SAECO 140322500 <i>OR 2118 IN NITRIL RUBBER</i>
	46		11029879	ПОРШЕНЬ РОБОЧОГО БЛОКУ X 7 ГРАМ <i>ASS.PISTONE X GRUPPO CAFFE'</i>

# Model Machine

MACSAE341

ВЕНДІНГ DIAMANTE RST BLK(10004840 )

MACSAE341.T.0019

TAVOLA NR. 19 - ARTICOLO ВЕНДІНГ DIAMANTE RST BLK( 10004840 )

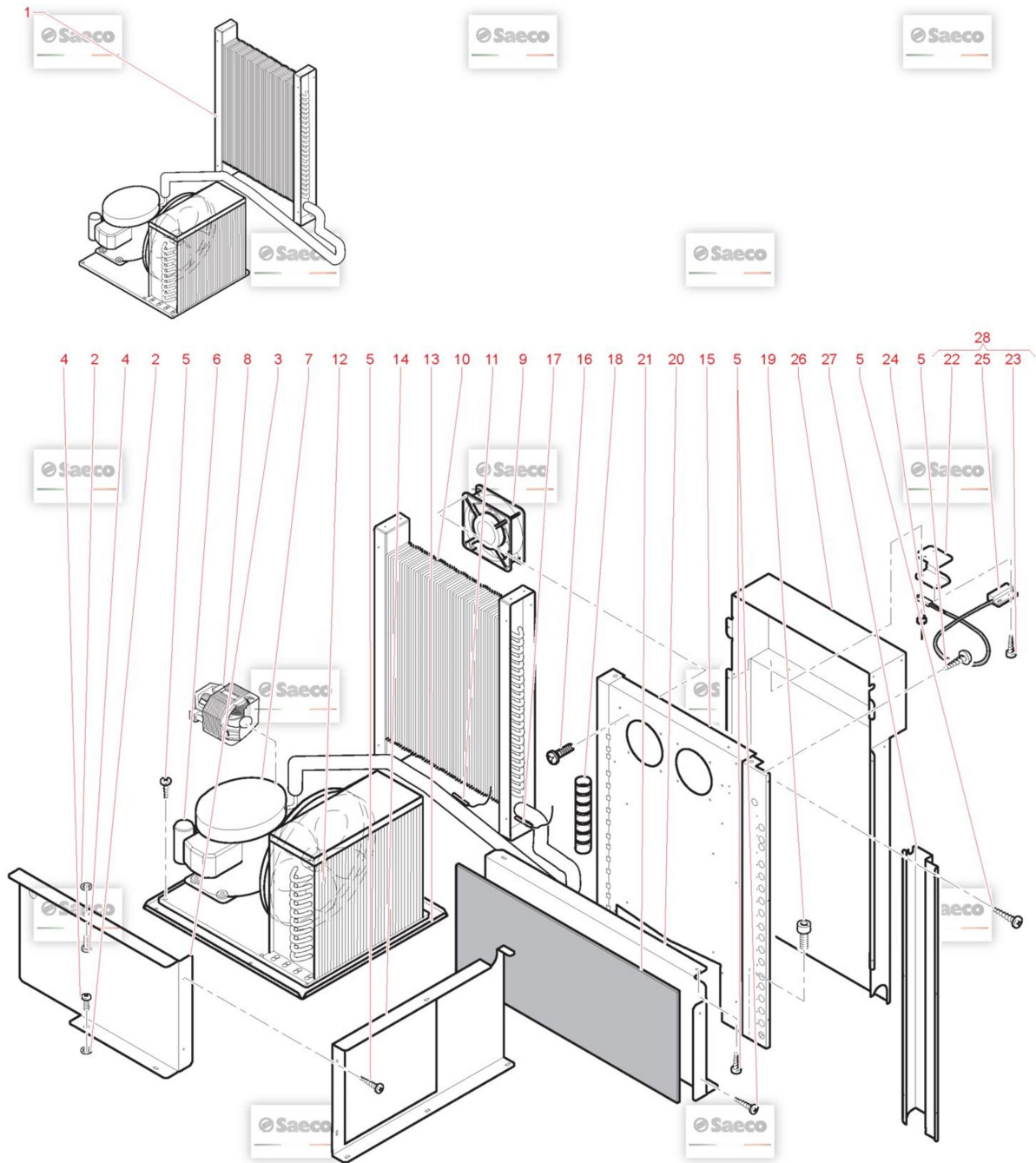

## Model Machine

MACSAE341

ВЕНДІНГ DIAMANTE RST BLK(10004840 )

Web Pos. Foto Item - Replace by Description



Press - CTRL + CLICK go to item in a new window  
Натисніть - Ctrl + права кнопка миші щоб відкрити запчастину в новому вікні



1



9169.A14.150

PIN FOR PERCOLATOR GREY  
ASS.PERNO X DOCCIA COMPLETO GRIGIO



2



NM02.006

OR R5 TERMOIL  
OR R5 EPDM



3



NM01.044

OR ORM 0320-40 SILICONE PTFE/FDA  
OR ORM 0320-40 SILICONE PTFE



4



9161.036

UPPER PERCOLATOR FOR UNIT  
DOCCIA SUPERIORE X GRUPPO



5



11005371

UNIT COFFEE MUFF  
MANICOTTO GRUPPO CAFFE' UNIT COFFEE MUFF



6



129512921

SCREW TCB TORX 10 AB 2,9X13 SHEET SS  
SCREW TCB TORX 10 2,9X13 SHEET SS



7



11010013

CARTER FOR MUFF PREHEATING UNIT  
CARTE X MANICOTTO GRUPPO PRERISCALDO



8



9111.537.150

GREY SCRAPER COFFEE GROUP  
GREY SCRAPER COFFEE GROUP



9



9111.520

SPRING FOR SCRAPER SECTION 0.6  
SPRING FOR SCRAPER SECTION 0.6



10



U701.006

ФІКСУЮЧА СКОБА 3,2 (ЗАЛІЗО) SAECO  
ANELLO ELASTICO 3,2



11



9111.539.150

FORK FOR SCRAPER  
FORCELLA PER RASCHIATORE



12



9110.067.150

SCRAPER ASS.FOR CAPPUCCINAT. TUBE  
ASS.RASCHIATORE X SG500/700



13

























U110.013

БОЛТ МЕТАЛЕВИЙ 3,9X6,5 DIN 7981 F  
SCREW AUT.TCB 3,9X6,5 DIN 7981 F

## Model Machine

MACSAE341

ВЕНДІНГ DIAMANTE RST BLK(10004840 )

	14		140321462	O-RING 2018 SILICONE <i>OR 2018 IN SILICONE</i>
	15		9972.057	КОРИЧНЕВА ГУМОВА ТРУБКА 5X8 2 МЕТРИ <i>TUBO SILICONE MARRON 5X8 L.2000 MM</i>
	16		9111.349	ELBOW DISPENSING NOZZLE <i>UGELLO EROGAZIONE GOMITO</i>
	17		322001259	ПЛАСТИКОВА ВОРНОКА ПОДАЧІ КАВИ (ПЛАСТИК) ЧОРНИЙ <i>MOBILE SCRAPER GREY NARROW</i>
	18		9161.425	SPRING FOR SCRAPER <i>SPRING FOR SCRAPER</i>
	19		129851921	TSP SCREW M3X6 UNI 7688 SS <i>TSP SCREW M3X6 UNI 7688 SS</i>
	20		9161.037	LOWER PERCOLATOR FOR UNIT <i>DOCCIA INFERIORE X GRUPPO</i>
	21		11002626	ASS. COFFEE CONTAINER GREY 9 GR. <i>ASS. COFFEE CONTAINER GREY 9 GR.</i>
	22		9161.021.060	KEY FOR BREW UNIT BROWN <i>CHIAVE X GRUPPO CAFFE' MARRO</i>
	23		11005422	ЗАВАРЮВАЛЬНИЙ БЛОК 9GR SAECO 996530002882 <i>GRUPPO CAFFE' 9GR CRISTALLO 600</i>
	24		11013053	CARTER FOR DOSER UNIT <i>CARTER FOR DOSER UNIT</i>

# Model Machine

MACSAE341

ВЕЃДИЃ DIAMANTE RST BLK(10004840 )

MACSAE341.T.0020

TAVOLA NR. 20 - ARTICOLO VEЃДИЃ DIAMANTE RST BLK( 10004840 )

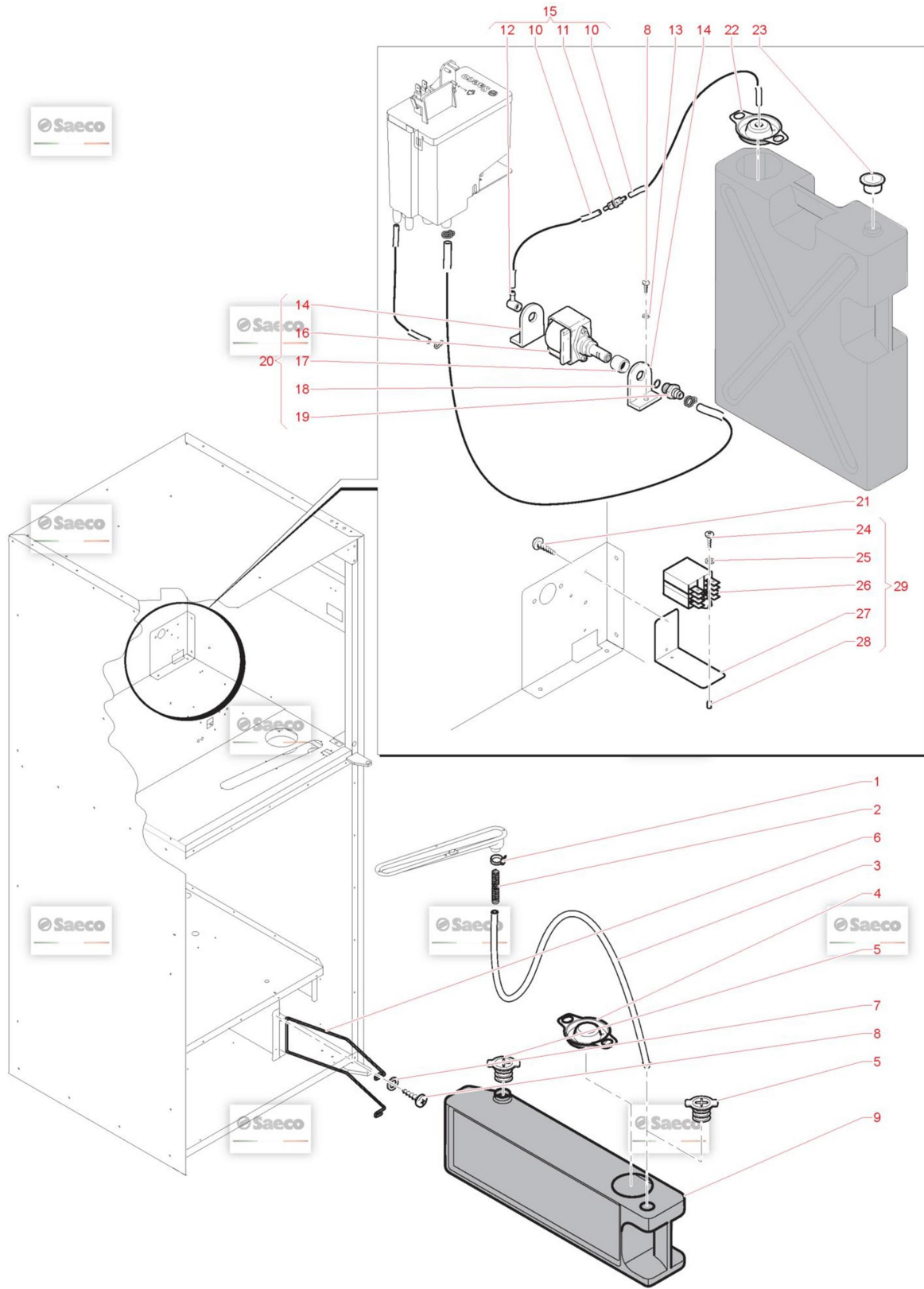

## Model Machine

MACSAE341

ВЕНДІНГ DIAMANTE RST BLK(10004840 )

Web Pos. Foto Item - Replace by Description



*Press - CTRL + CLICK go to item in a new window  
Натисніть - Ctrl + права кнопка миші щоб відкрити запчастину в новому вікні*



1



9169.A14.150

PIN FOR PERCOLATOR GREY  
ASS.PERNO X DOCCIA COMPLETO GRIGIO



2



NM02.006

OR R5 TERMOIL  
OR R5 EPDM



3



11007343

НОСИК В ЗБОРІ 10 ГРАМ  
ASS.COUNTERPISTON FRESH-BREW



4



9972.057

КОРИЧНЕВА ГУМОВА ТРУБКА 5X8 2 МЕТРИ  
TUBO SILICONE MARRON 5X8 L.2000 MM



5



9111.349

ELBOW DISPENSING NOZZLE  
UGELLO EROGAZIONE GOMITO



6



9111.537.150

GREY SCRAPER COFFEE GROUP  
GREY SCRAPER COFFEE GROUP



7



9111.520

SPRING FOR SCRAPER SECTION 0.6  
SPRING FOR SCRAPER SECTION 0.6



8



U701.006

ФІКСУЮЧА СКОБА 3,2 (ЗАПІЗО) SAECO  
ANELLO ELASTICO 3,2



9



9111.539.150

FORK FOR SCRAPER  
FORCELLA PER RASCHIATORE



10



9110.067.150

SCRAPER ASS.FOR CAPPUCCINAT. TUBE  
ASS.RASCHIATORE X SG500/700



11



U110.013

БОЛТ МЕТАЛЕВИЙ 3,9X6,5 DIN 7981 F  
SCREW AUT.TCB 3,9X6,5 DIN 7981 F



12

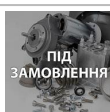

U109.030

САМОРІЗ AUT.TCB 2,9X16 DIN 7981 C  
SCREW AUT.TCB 2,9X16 DIN 7981 C



13













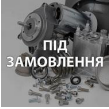







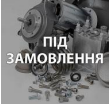



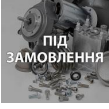



11003470

КРИШКА НОСИКА  
LID X COUNTERPISTON FRESH-BREW

## Model Machine

MACSAE341

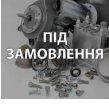
ВЕНДІНГ DIAMANTE RST BLK(10004840 )





















	14		<b>NM02.013</b>	OR ORM 0080-15 TERMOIL <i>OR ORM 0080-15 TERMOIL</i>
	15		<b>11028830</b>	ПРУЖИНКА ДЛЯ FS400 ПІД ШАРИК ПОРШНЯ <i>SPRING FOR FS400 COVER CHASSIS</i>
	16		<b>12001650</b>	SPHERE TEFLON D.5 <i>SPHERE TEFLON D.5</i>
	17		<b>U302.003</b>	МЕТАЛЕВА ГАЙКА M4 UNI 5588 ZNP <i>DADO ESAGONALE M4 UNI 5588 ZNP</i>
	18		<b>11003472</b>	RUBBER X UNIT FRESH-BREW <i>RUBBER X UNIT FRESH-BREW</i>
	19		<b>140320461</b>	OR ORM 0080-20 TERMOIL <i>OR ORM 0080-20 IN TERMOIL</i>
	20		<b>322000559</b>	WATER FLOW PISTON GREY <i>WATER FLOW PISTON GREY</i>
	21		<b>129512921</b>	SCREW TCB TORX 10 AB 2,9X13 SHEET SS <i>SCREW TCB TORX 10 2,9X13 SHEET SS</i>
	22		<b>140321462</b>	O-RING 2018 SILICONE <i>OR 2018 IN SILICONE</i>
	23		<b>11002603</b>	SPING FOR MEMBRANE <i>SPING FOR MEMBRANE</i>
	24		<b>11002625</b>	MEMBRANE <i>MEMBRANE</i>
	25		<b>11003471</b>	PIN FOR MEMBRANE FRESH-BREW <i>PIN FOR MEMBRANE FRESH-BREW</i>
	26		<b>11003469</b>	COUNTERPISTON FRESH-BREW <i>COUNTERPISTON FRESH-BREW</i>
	27		<b>NM01.044</b>	OR ORM 0320-40 SILICONE PTFE/FDA <i>OR ORM 0320-40 SILICONE PTFE</i>

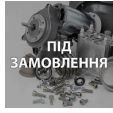

## Model Machine

MACSAE341

БЕНДІНГ DIAMANTE RST BLK(10004840 )

	28		9161.167	СИТО МЕТАЛЕВЕ D=35,8 SAECO 11008362 <i>PERCOLATOR D.35,8</i>
	29		11003529	HOPPER DOSER UNIT FRESH BREW <i>HOPPER DOSER UNIT FRESH BREW</i>
	30		126836618	SPRING H=28 NEW FOR SCRAPER <i>MOLLA H=28 NEW X RASCHIATORE</i>
	31		129851921	TSP SCREW M3X6 UNI 7688 SS <i>TSP SCREW M3X6 UNI 7688 SS</i>
	32		9161.037	LOWER PERCOLATOR FOR UNIT <i>DOCCIA INFERIORE X GRUPPO</i>
	33		11002626	ASS. COFFEE CONTAINER GREY 9 GR. <i>ASS. COFFEE CONTAINER GREY 9 GR.</i>
	34		9161.021.060	KEY FOR BREW UNIT BROWN <i>CHIAVE X GRUPPO CAFFE' MARRO</i>
	35		11007283	BREW UNIT 10GRAMS FRESH BREW <i>BREW UNIT 10GRAMS FRESH BREW</i>
	36		U301.003	ГАЙКА HEXAGONAL M3 UNI 5587 <i>NUT HEXAGONAL M3 UNI 5587</i>
	37		129852821	TSP SCREW M3X14 UNI 7688 SS <i>TSP SCREW M3X14 UNI 7688 SS</i>
	38		11013053	CARTER FOR DOSER UNIT <i>CARTER FOR DOSER UNIT</i>

## Model Machine

MACSAE341

ВЕНДИНГ DIAMANTE RST BLK(10004840 )

MACSAE341.T.0021

TAVOLA NR. 21 - ARTICOLO ВЕНДИНГ DIAMANTE RST BLK( 10004840 )

## Model Machine

MACSAE341

БЕНДІНГ DIAMANTE RST BLK(10004840 )

Web Pos. Foto Item - Replace by Description



Press - CTRL + CLICK go to item in a new window

Натисніть - Ctrl + права кнопка миші щоб відкрити запчастину в новому вікні



1



129512921

SCREW TCB TORX 10 AB 2,9X13 SHEET SS  
SCREW TCB TORX 10 2,9X13 SHEET SS



2

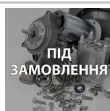

11031906

PLATE  
PLATE



3

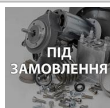

11004586

BLK COFFEE OUTLET CONVEYOR OCS  
BLK COFFEE OUTLET CONVEYOR OCS



3

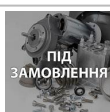

9161.356

BLK COFFEE OUTLET CONVEYOR LAV.  
BLK COFFEE OUTLET CONVEYOR LAV.



4

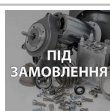

129912621

SCREW PT KB 30X8 WN 1413 INOXA2  
SCREW PT KB 30X8 WN 1413 INOX A2



5

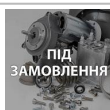

129911721

SCREW TSP TORX 4X16 PLAST STEEL  
SCREW TSP TORX 4X16 PLAST STEEL



6



9161.064.150

ВХІДНИЙ КЛАПАН ЗАВАРЮВАЛЬНОГО БЛОКУ КАВОВАРКИ SAECO ПРО...  
MANICOTTO ENTRATA ACQUA GRUP.CAF.GRIGIO CON OR NM02.007 - F...



7



NM02.007

OR 2025 IN TERMOIL  
OR 2025 TERMOIL



8

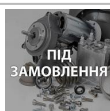

11013418

BLK COFF.CAPSULE FIXED CONTAINER V3 LAV.  
BLK COFF.CAPSULE FIXED CONTAINER V3 LAV.



8

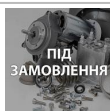

11034351

BLK COFF.CAPSULE FIXED CONTAINER  
CONT.FISSO CAPS LAVORATO CO BLK



8

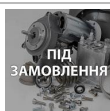

421941306941

CONT.FISSO CAPS.CAF.ATL700 CAGRI.  
GREY COFFEE CAPS.FIXED CONTAINER ATL700



9



11031760

SEAL FOR BREW UNIT CAPS  
SEAL FOR BREW UNIT CAPS



9

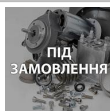











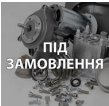

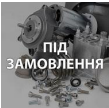













421941306911

SEAL FOR BREW UNIT CAPS CA  
SEAL FOR BREW UNIT CAPS CA

## Model Machine

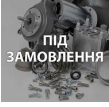
MACSAE341

















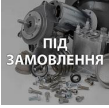





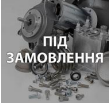

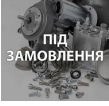
ВЕНДІНГ DIAMANTE RST BLK(10004840 )

	10		11031226	PIERCER GROUP CAPS <i>PIERCER GROUP CAPS</i>
	11		126773518	SS SPRING FOR COFFEE CAPSULE LAV. <i>SS SPRING FOR COFFEE CAPSULE LAV.</i>
	11		421941306921	SPRING FOR STEEL PIERCE BU CAPSULE CA <i>MOLLA X FORATORE CA</i>
	12		9161.373.150	GREY BREW UNIT COUPLING PLATESMART <i>GREY BREW UNIT COUPLING PLATE SMART</i>
	13		11013396	BLACK BREW UNIT REAR PLATE V3LAV. <i>BLACK BREW UNIT REAR PLATE V3 LAV.</i>
	14		12000550	CAMOPI3 TCB TORX 10 3X25 PLAST.SS <i>SCREW TCB TORX 10 3X25 PLAST.SS</i>
	15		120080722	ALUM.FEMALE ELBOW SHAFT <i>ALUM.FEMALE ELBOW SHAFT</i>
	16		120080622	ALUM.MALE ELBOW SHAFT <i>ALUM.MALE ELBOW SHAFT</i>
	17		11032146	GREY BREW UNIT CONNECTING RODCAPS <i>GREY BREW UNIT CONNECTING ROD CAPS</i>
	18		9161.094.050	BLACK BREW UNIT DRILLED BLOCK <i>BLACK BREW UNIT DRILLED BLOCK</i>
	19		129574421	SCREW TCB PH/TT 4X20 UNI 8112ST.ST <i>SCREW TCB PH/TT 4X20 UNI 8112 ST.ST</i>
	20		9161.298	BRASS SPACER <i>BRASS SPACER</i>
	21		11011770	CASING TO MOVABLE DRILLING PLATE V3 LAV. <i>CORPO A PIATTEL.MOBILE FORATO V3 LAV.NER</i>
	21		142906059	CASING TO MOVABLE DRILLING PLATE <i>CASING TO MOVABLE DRILLING PLATE</i>

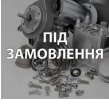
## Model Machine

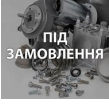
MACSAE341

















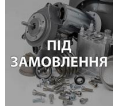

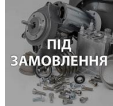

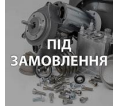

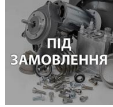

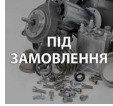

ВЕНДІНГ DIAMANTE RST BLK(10004840 )

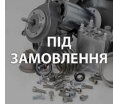
	22		<b>11026624</b>	LIP SEAL FOR CAPS.EXPELLER PISTON V4 LAV <i>LIP SEAL FOR CAPS.EXPELLER PISTON V4 LAV</i>
	22		<b>145855700</b>	LIP SEAL FOR EXPELLER PISTON OCS <i>LIP SEAL FOR EXPELLER PISTON OCS</i>
	23		<b>126772418</b>	COFF.CAPSULE EXPELLER PISTON SPRING LAV. <i>COFF.CAPSULE EXPELLER PISTON SPRING LAV.</i>
	23		<b>126774118</b>	SPIRAL SPRING FOR PISTON EXPELLER <i>SPIRAL SPRING FOR PISTON EXPELLER</i>
	24		<b>129910921</b>	SCREW TCB TORX 10 3X10 SS <i>SCREW TCB TORX 10 3X10 SS</i>
	25		<b>149198000</b>	COFFEE CAPS.LOWER DRILLING SUPPORT LAV. <i>COFFEE CAPS.LOWER DRILLING SUPPORT LAV.</i>
	26		<b>229211859</b>	COFFEE CAPSULE EXPELLER PISTONLAV. <i>COFFEE CAPSULE EXPELLER PISTON LAV.</i>
	26		<b>229211959</b>	COFFEE CAPSULE EXPELLER PISTONOCS <i>COFFEE CAPSULE EXPELLER PISTON OCS</i>
	27		<b>NM02.018</b>	OR ORM 0090-25 TERMOIL <i>OR ORM 0090-25 TERMOIL</i>
	28		<b>421941306881</b>	MOBILE CONT. BU CAPS V3 ATL 700 ASSY <i>MOBILE CONT. BU CAPS V3 ATL 700 ASSY</i>
	28		<b>421941306901</b>	MOBILE CONTAINER BU OCS CAPS ATL700 ASSY <i>ASS.CONT.MOBILE GRUPPO CAPS ATL700 GRY</i>
	29		<b>11031018</b>	HOPPER COFFEE GROUP <i>HOPPER COFFEE GROUP</i>
	30		<b>11026626</b>	PISTON EXPELLER COFFEE CAPSULEV4 ASSY. <i>PISTON EXPELLER COFFEE CAPSULE V4 ASSY.</i>

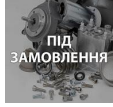
## Model Machine

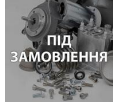
MACSAE341

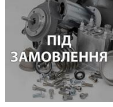













ВЕНДІНГ DIAMANTE RST BLK(10004840 )

	30		227661000	PISTON AS.EXPELLER COFF.CAPSULE OCS ASSY <i>PISTON AS.EXPELLER COFF.CAPSULE OCS ASSY</i>
	31		12000895	SCREW TSP TORX 10 3X10 PLAST.SS <i>SCREW TSP TORX 10 3X10 PLAST.SS</i>
	32		9161.378	SS HOPPER SPRING FOR BREW UNITSMART <i>SS HOPPER SPRING FOR BREW UNIT SMART</i>
	33	 ПІД ЗАМОВЛЕННЯ	9161.374.150	GRY BREWUNIT HOPPER BLOCKING PLATE SMART <i>GRY BREWUNIT HOPPER BLOCKING PLATE SMART</i>
	34	 ПІД ЗАМОВЛЕННЯ	11014199	BLK BREW UNIT FRONT PLATE V3 S/SCR.LAV. <i>BLK BREW UNIT FRONT PLATE V3 S/SCR.LAV.</i>
	35	 ПІД ЗАМОВЛЕННЯ	U023.011	SCREW TCEI M4,0X10 UNI 5931 SSA <i>SCREW TCEI M4,0X10 UNI 5931 SS A</i>
	36	 ПІД ЗАМОВЛЕННЯ	12000897	SCREW TCB TORX 10 3,5X20 PLAST.SS <i>SCREW TCB TORX 10 3,5X20 PLAST.SS</i>
	37		11031702	РОБОЧА ГРУПА V4 BLK SAECO ATLANTE, CRISTALLLO <i>COFFEE GROUP V4 ATLANTE CAPS BLK</i>
	37	 ПІД ЗАМОВЛЕННЯ	11032374	BLACK BREW UNIT V2 CAP CA <i>BLACK BREW UNIT V2 ATLANTE CAPS CA</i>
	37	 ПІД ЗАМОВЛЕННЯ	11034353	BREW UNIT CAPS CO <i>BREW UNIT CAPS CO</i>
	39	 ПІД ЗАМОВЛЕННЯ	1040.028.050	STD TOOTHED CONNECT. F3/8X09 <i>STD TOOTHED CONNECT. F3/8X09</i>
	40	 ПІД ЗАМОВЛЕННЯ	11031829	COFF.CAPSULE FIXED CONT.V3 ATL700 ASSY. <i>COFF.CAPSULE FIXED CONT.V3 ATL700 ASSY.</i>
	40	 ПІД ЗАМОВЛЕННЯ	11034352	CAPSULE FIXED CONT. CO ASSY. <i>CAPSULE FIXED CONT. CO ASSY.</i>
	40	 ПІД ЗАМОВЛЕННЯ	11034993	CAPSULE FIXED CONT. CA ASSY. <i>ASS.CONT.FISSO CAPS CA</i>

## Model Machine

MACSAE341

ВЕНДІНГ DIAMANTE RST BLK(10004840 )

	41		11032468	SILICONE TUBE 3,5X6 L=2000 MM <i>SILICONE TUBE 3.5 X 6 L=2000 MM</i>
	42	 ПІД ЗАМОВЛЕННЯ	11033574	COFFEE NOZZLES <i>COFFEE NOZZLES</i>
	43	 ПІД ЗАМОВЛЕННЯ	421941306931	STAINLESS STEEL PIERCER OUTLET COFFEE CA <i>CORPO FORATORE CA USCITA CAFFE' OCS INOX</i>
	44	 ПІД ЗАМОВЛЕННЯ	120340421	ELAST.SHAFT RETAIN.RING D=5 UNI7435 <i>ELAST.SHAFT RETAIN.RING D=5 UNI7435</i>
	45	 ПІД ЗАМОВЛЕННЯ	149203000	LOWER COFF.CAPSULE DRILLING SUPPORT OCS <i>LOWER COFF.CAPSULE DRILLING SUPPORT OCS</i>
	46	 ПІД ЗАМОВЛЕННЯ	122908721	STAINLESS STEEL PIERCER INLET WATER OCS <i>STAINLESS STEEL PIERCER INLET WATER OCS</i>
	47	 ПІД ЗАМОВЛЕННЯ	11032349	ANTI-OVERTURNING PLATE <i>ANTI-OVERTURNING PLATE</i>