

Model Machine

MACSAE304

CRISTALLO 600 EVO 7GPM 1K (10004817)

MACSAE304.T.0001



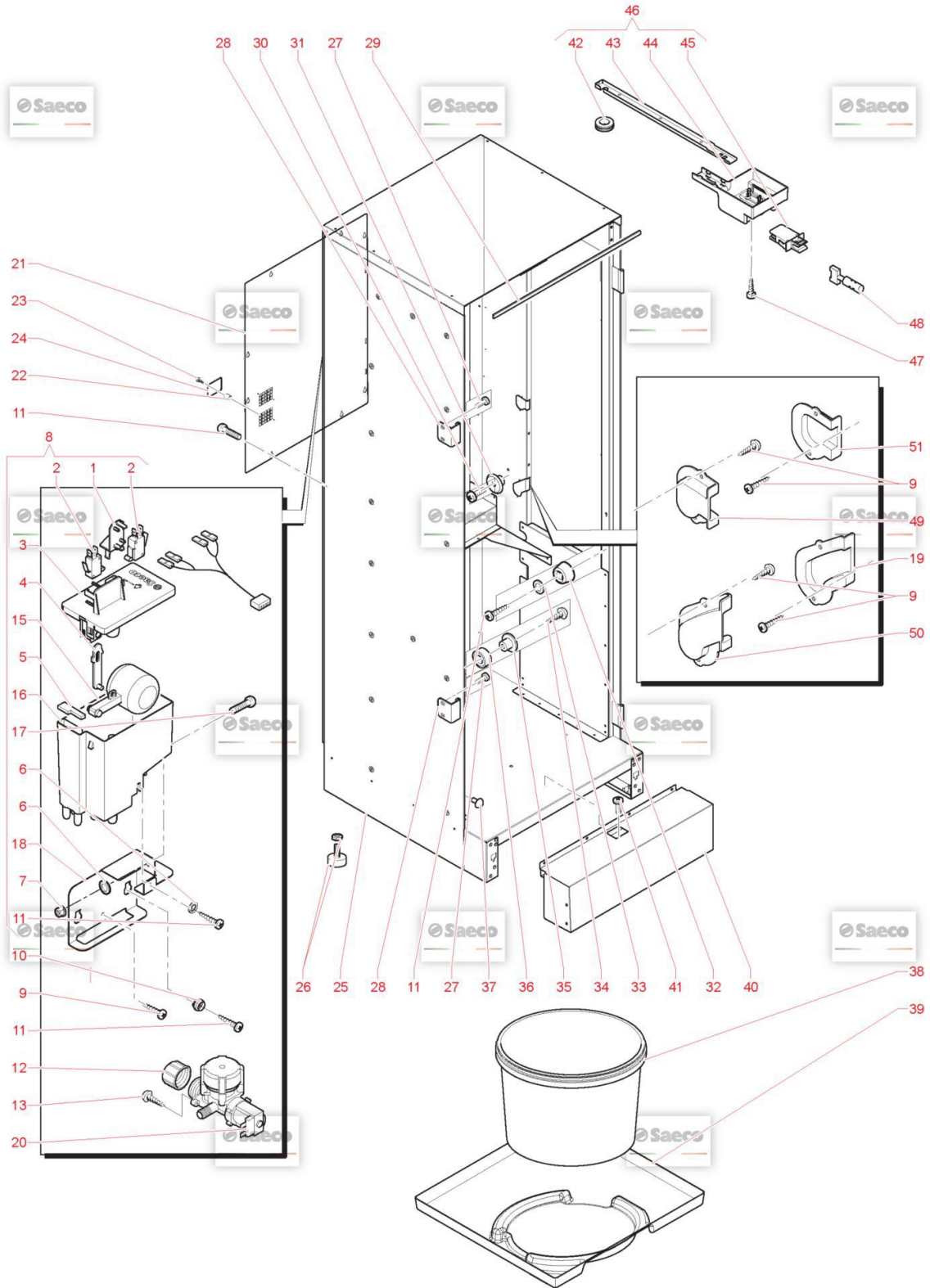





















TAVOLA NR. 1 - ARTICOLO CRISTALLO 600 EVO 7GPM 1K (10004817)

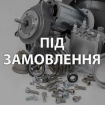

Model Machine

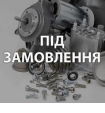
MACSAE304











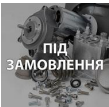

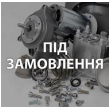













CRISTALLO 600 EVO 7GPM 1K (10004817)

Web	Pos.	Foto	Item - Replace by	Description
				<i>Press - CTRL + CLICK go to item in a new window Натисніть - Ctrl + права кнопка миші щоб відкрити запчастину в новому вікні</i>
	1		9161.207.150	GREY FAUCET MICRO SUPPORT M5000 <i>SUPPORTO X MICRO RUBINETTO</i>
	2		NE05.062	MICROSWITCH + WHEEL <i>MICROINTERRUTTORE C/ROTELLA</i>
	3		9111.623	LID TANK AIR BREAK <i>COPERCHIO X SERBATOIO AIR BREAK</i>
	4		9111.621	CONNECTING ROD TANK WATER <i>CONNECTING ROD TANK WATER</i>
	5		9111.632	RUBBER FOR AIR BREAK <i>RUBBER FOR AIR BREAK</i>
	6		U207.009	PLAIN WASHER 5,5X15 UNI 6593 GA <i>PLAIN WASHER 5,5X15 UNI 6593 GA</i>
	7		U324.003	NUT M5 FLANGED INDENTED BASE <i>NUT M5 FLANGED INDENTED BASE</i>
	8		11006703	ASSEMBLY AIR BREAK CRISTALLO400 <i>ASSEMBLY AIR BREAK CRISTALLO400</i>
	9		U143.022	SCREW T.M.T. K.F.R. 3,5X9,5 ZNP <i>VITE T.M.T. K.F.R. 3,5X9,5 ZNP</i>
	10		11011054	PIN FOR BOSS D.8 <i>PIN FOR BOSS D.8</i>
	11		U110.005	SCREW AUT.TCB 3,9X9,5 DIN 7981F <i>VITE AUT.TCB 3,9X9,5 DIN 798</i>
	12		NV03.002	КРИШКА КЛАПАНА ПОДАЧІ ВОДИ 3/4 <i>"CAP 3/4 "KAPSTO 800R 3/4""</i>

Model Machine

MACSAE304

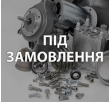











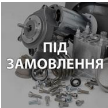



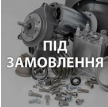







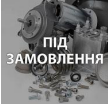

CRISTALLO 600 EVO 7GPM 1K (10004817)

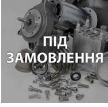
	13	 ПІД ЗАМОВЛЕННЯ	U110.002	SCREW AUT.TCB 3,5X13 DIN 7981F <i>SCREW AUT.TCB 3,5X13 DIN 7981 F</i>
	14	 ПІД ЗАМОВЛЕННЯ	11033893	HARNESS MICRO AIR BREAK CRS600EVO <i>HARNESS MICRO AIR BREAK CRS600EVO</i>
	15		9111.508	FLOAT FOR AIR BREAK BOWL <i>FLOAT FOR AIR BREAK BOWL</i>
	16	 ПІД ЗАМОВЛЕННЯ	9111.641	TANK AIR BREAK <i>SERBATOIO AIR BREAK C/FORO</i>
	17		U043.015	SCREW TCBC M5,0X12 UNI 7687 GALV. <i>SCREW TCBC M5,0X12 UNI 7687 GALV.</i>
	18		1863.015	AIR BREAK SUPPORT <i>AIR BREAK SUPPORT</i>
	19	 ПІД ЗАМОВЛЕННЯ	1863.019.A20	LOWER GUIDE RIGHT PLATE <i>LOWER GUIDE RIGHT PLATE</i>
	20		9121.057.00P	SAFETY ELECTROVALVE 24V DC <i>SAFETY ELECTROVALVE 24V DC</i>
	21	 ПІД ЗАМОВЛЕННЯ	11034045	BACK PANEL INSPECTION CRS EVO <i>BACK PANEL INSPECTION CRS EVO</i>
	22	 ПІД ЗАМОВЛЕННЯ	11010659	SPACER FOR DEFLECTOR <i>SPACER FOR DEFLECTOR</i>
	23		129516803	SCREW TCB3,5X19 DIN 7981 NICK <i>SCREW TCB3,5X19 DIN 7981 NICK</i>
	24	 ПІД ЗАМОВЛЕННЯ	11010658	AIR DEFLECTOR PLATE <i>AIR DEFLECTOR PLATE</i>
	25	 ПІД ЗАМОВЛЕННЯ	11033150	FS6N CHASSIS <i>FS6N CHASSIS</i>
	26		NV01.002	FOOT D.34 H.35 WITH NUT M10 <i>PIEDINO D.34 H.35 CON DADO M</i>

Model Machine

MACSAE304

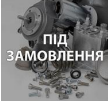













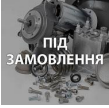





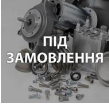

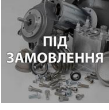

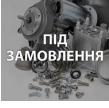
CRISTALLO 600 EVO 7GPM 1K (10004817)

	27		129824002	TCB SCREW M4X10 UNI 7687 ZNP <i>VITE TCB M4X10 UNI 7687 ZNP</i>
	28		11027979	ROD LOCK HOOKUP SEAGA <i>AGGANCIO ASTA X SERRATURA A 3 PUNTI</i>
	29		1863.073	DOOR SEAL FS400 <i>DOOR SEAL FS400</i>
	30		U043.014	SCREW TCBC M5,0X20 UNI 7687 GALV. <i>SCREW TCBC M5,0X20 UNI 7687 GALV.</i>
	31		9111.763.270	PIN <i>PIN</i>
	32		NV01.013	FOOT BUFFER D.20 X H10 <i>FOOT BUFFER D.20 X H10</i>
	33		U203.001	ШАЙБА 4,3X8 UNI 1749 GA <i>PLAIN WASHER 4,3X8 UNI 1749 GAL</i>
	34		12000780	SCREW TSPC M4,0X20 UNI 7688 GALV. <i>SCREW TSPC M4,0X20 UNI 7688 GALV.</i>
	35		11006477	FS400 DOOR PIVOT FOR WHEEL <i>FS400 DOOR PIVOT FOR WHEEL</i>
	36		11003474	FS400 DOOR WHEEL <i>FS400 DOOR WHEEL</i>
	37		NV01.014	RUBBER BUFFER FOR DOOR <i>GOMMINO PARACOLPI X PORTA</i>
	38		12002042	BUCKET UTILPLASTIC 328X250X300BLACK <i>BUCKET UTILPLASTIC 328X250X300 BLACK</i>
	39		11032654	BOTTOM TUB <i>BOTTOM TUB</i>
	40		11033011	BASEBOARD ASSEMBLY <i>BASEBOARD ASSEMBLY</i>

Model Machine

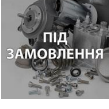
MACSAE304

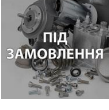
CRISTALLO 600 EVO 7GPM 1K (10004817)

	41		12002052	ZN-B TCB SCREW M4X16 <i>ZN-B TCB SCREW M4X16</i>
	42		NE16.002	GROMMET D.11X20,5XH.7 <i>GROMMET D.11X20,5XH.7</i>
	43	 ПІД ЗАМОВЛЕННЯ	1863.034	CHANNEL FOR DOOR CABLES <i>CHANNEL FOR DOOR CABLES</i>
	44	 Liberty	1863.035.A20	SUPPORT FOR MICRO DOOR <i>SUPPORTO MICRO PORTA</i>
	45		NE05.039	BIPOLAR MICROSWITCH <i>MICROINTERRUTTORE BIPOLARE</i>
	45	 ПІД ЗАМОВЛЕННЯ	NE05.061	MICROSWITCH CHERRY D413 .V3LD <i>MICROINT.BIPOLARE XTD 22AZ1</i>
	46	 ПІД ЗАМОВЛЕННЯ	11032297	MICRO ROOF <i>MICRO ROOF</i>
	46	 ПІД ЗАМОВЛЕННЯ	11032298	MICRO ROOF <i>MICRO ROOF</i>
	47		U116.006	SCREW AUT.PT TCB 3,5X12 WN 1441 ZNP <i>VITE AUT.PT TCB 3,5X12 WN 1441 ZNP</i>
	48		NE05.040	KEY FOR MICRO <i>CHIAVE X MICRO</i>
	49	 ПІД ЗАМОВЛЕННЯ	1863.016.A20	UPPER GUIDE LEFT PLATE <i>UPPER GUIDE LEFT PLATE</i>
	50	 ПІД ЗАМОВЛЕННЯ	1863.017.A20	LOWER GUIDE LEFT PLATE <i>LOWER GUIDE LEFT PLATE</i>
	51	 ПІД ЗАМОВЛЕННЯ	1863.018.A20	UPPER GUIDE RIGHT PLATE <i>UPPER GUIDE RIGHT PLATE</i>

Model Machine

MACSAE304

CRISTALLO 600 EVO 7GPM 1K (10004817)

MACSAE304.T.0002

TAVOLA NR. 2 - ARTICOLO CRISTALLO 600 EVO 7GPM 1K (10004817)

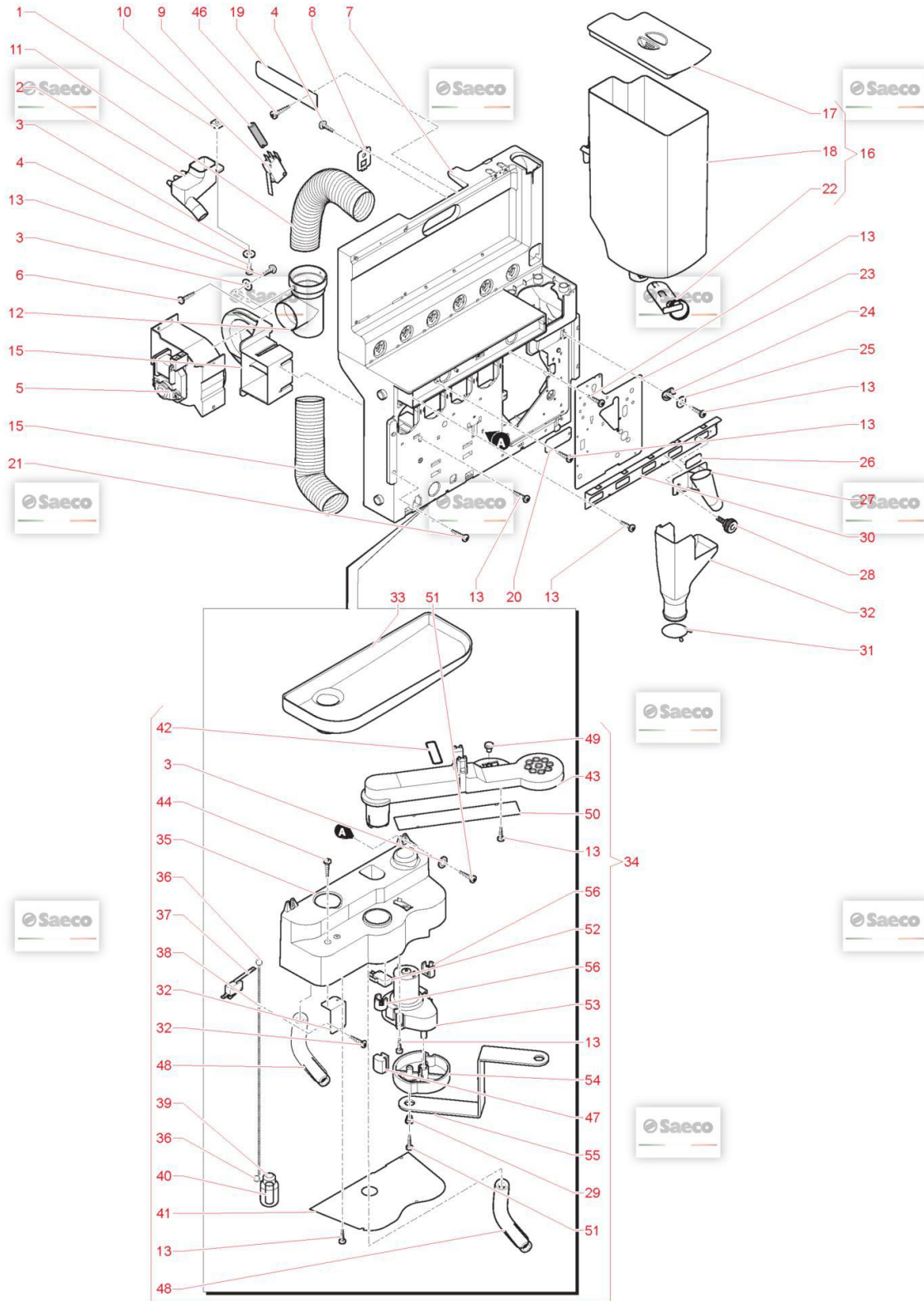

Model Machine

MACSAE304

CRISTALLO 600 EVO 7GPM 1K (10004817)

Web Pos. Foto Item - Replace by Description



*Press - CTRL + CLICK go to item in a new window
Натисніть - Ctrl + права кнопка миші щоб відкрити запчастину в новому вікні*



1



U315.001

NUT SQUARE M4 UNI 5596 GALV.
NUT SQUARE M4 UNI 5596 GALV.



2



11030483

SYPHON
SIFONE FORATO



3



U207.002

PLAIN WASHER 4,3X9 UNI 6592 GAL
ROSETTA PIANA 4,3X9 UNI 6592 ZNP



4

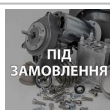

129825002

TCB SCREW M4X20 UNI 7687 ZNP
TCB SCREW M4X20 UNI 7687 ZNP



5



11003905

ВЕНТИЛЯТОР 120 VL
CENTRIFUGAL FAN 120V UL



5



9121.198.00A

ВЕНТИЛЯТОР ВИТЯЖКИ 07 120X100X100 SAECO 9121.198.00A
VENTILATORE CENTRIFUGO CAP 07



6



U109.005

SCREW AUT.TCB 3,5X16 DIN 7981C
VITE AUT.TCB 3,5X16 DIN 798



7

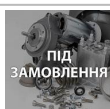

9111.708.A20

MAIN PLATE
PIASTRA PRINCIPALE



8

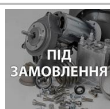

9111.766

CONNECTING PLATE
CONNECTING PLATE



9

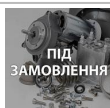

1883.004

SHEATH
SHEATH



10



NE05.018

MICROSWITCH
MICROINTERRUPTORE SAECO XCG5-81-P5



11

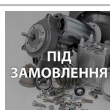

0862.014

ASPIRATOR TUBE L=290
ASPIRATOR TUBE L=290



12















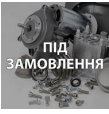

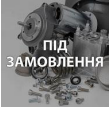







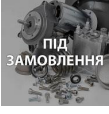

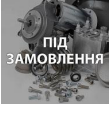

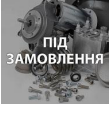
9111.640.060

TUBE CONNECTOR
TUBE CONNECTOR

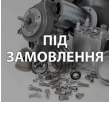
Model Machine

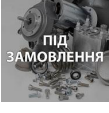
MACSAE304

















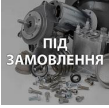





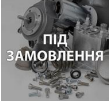

CRISTALLO 600 EVO 7GPM 1K (10004817)

	13		U116.006	SCREW AUT.PT TCB 3,5X12 WN 1441 ZNP <i>VITE AUT.PT TCB 3,5X12 WN 1441 ZNP</i>
	14		9111.732.A20	SUPPORT <i>SUPPORT</i>
	15		0862.145	SPIRAL TUBE L.210MM <i>SPIRAL TUBE L.210MM</i>
	16		9110.139	COFFEE CONT. ASS. <i>ASS.CONTENTITORE CAFFE'</i>
	17		9111.728	COVER FOR COFFEE CONTAINER <i>COPERCHIO CONTENTITORE CAFFE'</i>
	18		9111.724	CONTAINER FOR COFFEE BEAN <i>CONTENTITORE CAFFE' IN GRANI</i>
	19		11000887	WIRES SAFE PLATE <i>WIRES SAFE PLATE</i>
	20		11000793	MIXER ASPIRATION PLATE <i>MIXER ASPIRATION PLATE</i>
	21		U023.009	SCREW TCEI M5,0X30 UNI 5931 8.8 B <i>SCREW TCEI M5,0X30 UNI 5931 8.8 B</i>
	22		11010736	ASS.GUILLOTINE COFFEE (1813.027) <i>ASS.GUILLOTINE COFFEE</i>
	23		9111.711	INOX. PLATE <i>INOX. PLATE</i>
	24		9111.717.270	KNOB FIXING PLATE <i>KNOB FIXING PLATE</i>
	25		U207.001	PLAIN WASHER 5,3X10 UNI 6592 GAL <i>ROSETTA PIANA 5,3X10 UNI 6</i>
	26		9111.481.060	COLUMN CAP <i>COLUMN CAP</i>

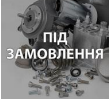
Model Machine

MACSAE304











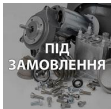

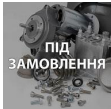









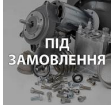

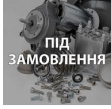

CRISTALLO 600 EVO 7GPM 1K (10004817)

	27		11011651	SOLUBLECONVEYOR TTT <i>SOLUBLECONVEYOR TTT</i>
	28		12002031	KNOB D.18 M5X15 <i>KNOB D.18 M5X15</i>
	29		9111.204	BUSH FOR SPRING COMPENSATE STIRRER <i>BOCCOLA X MOLLA BILANCERE PALETTE</i>
	30		11011713	CRISTALLO400 TTT CANISTER'L FIXING PLATE <i>CRISTALLO400 TTT CANISTER'L FIXING PLATE</i>
	30		9111.712	INOX. PLATE FOR MIXERS <i>INOX. PLATE FOR MIXERS</i>
	31		0862.112	GROUNDS SACK RING 8P <i>КОЛЬЦО ANELLO SACCO FONDI 8P</i>
	32		0862.111.050	GROUNDS DUCT <i>CONDOTTO X FONDI</i>
	33		9111.714.A20	TANK <i>TANK</i>
	34		11033202	NOZZLE ARM <i>NOZZLE ARM</i>
	34		11033203	UL ASSEMBLED NOZZLES ARM <i>UL ASSEMBLED NOZZLES ARM</i>
	35		11033186	SUPPORT NOZZLE ARM <i>SUPPORT NOZZLE ARM</i>
	36		9111.148	ELASTIC RING FOR FLOAT <i>ANELLO ELASTICO X GALLEGGIANTE</i>
	37		NE05.041	MICROSWITCH <i>MICROINTERRUTTORE</i>

Model Machine

MACSAE304











CRISTALLO 600 EVO 7GPM 1K (10004817)

	38		9111.775	CHAIN CHAIN
	39		9111.130	FLOAT FOR DISCHARGE LEVEL FLOAT FOR DISCHARGE LEVEL
	40		9111.147	COUNTERWEIGHT FOR FLOAT CONTRAPPESO X GALLEGGIANTE
	41		9111.722	PLATE PIASTRA SUPPORTO BRACCIO
	42		140321560	O-RING 3187 NBR OR 3187 IN NBR
	43		9111.710.A20	NOZZLE ARM BRACCIO GIREVOLE
	44		129512903	SCREW TCB PH-AB 2,9X13 UNI 6954 NI SCREW TCB PH-AB 2,9X13 UNI 6954 NI
	45		9111.719	PLATE PLATE
	46		U109.003	SCREW TCB 3,5X9,5 DIN 7981 C NICK SCREW TCB 3,5X9,5 DIN 7981 C NICK
	47		0875.150	RUBBER FOR DISPENSING COMP. RUBBER FOR DISPENSING COMP.
	48		11001454	PVC TUBE 16X22 L.350 MM TUBO PVC 16X22 L.180MM
	49		NV01.009	RUBBER BUFFER GOMMINO PARACOLPI
	50		9111.723	PLATE PIASTRA X BRACCIO
	51		U116.002	SCREW AUT.PT TCB 3,5X16 WN 1441 SCREW AUT.PT TCB 3,5X16 WN 1441

Model Machine

MACSAE304

CRISTALLO 600 EVO 7GPM 1K (10004817)

	52		NE05.010	MICROSWITCH <i>MICROINTERRUPTORE</i>
	53		11033191	GEARMOTOR MECHTEX 25 RPM <i>MOTORIDUTTORE MECHTEX 25 RPM</i>
	54		9111.716.A20	CAM ARM <i>CAMMA BRACCIO</i>
	55		9111.715	CONNECTING ROD ARM <i>BIELLA BRACCIO</i>
	56		11033193	SPACER MOTOR ARM <i>SPACER MOTOR ARM</i>

Model Machine

MACSAE304

CRISTALLO 600 EVO 7GPM 1K (10004817)

MACSAE304.T.0003

TAVOLA NR. 3 - ARTICOLO CRISTALLO 600 EVO 7GPM 1K (10004817)

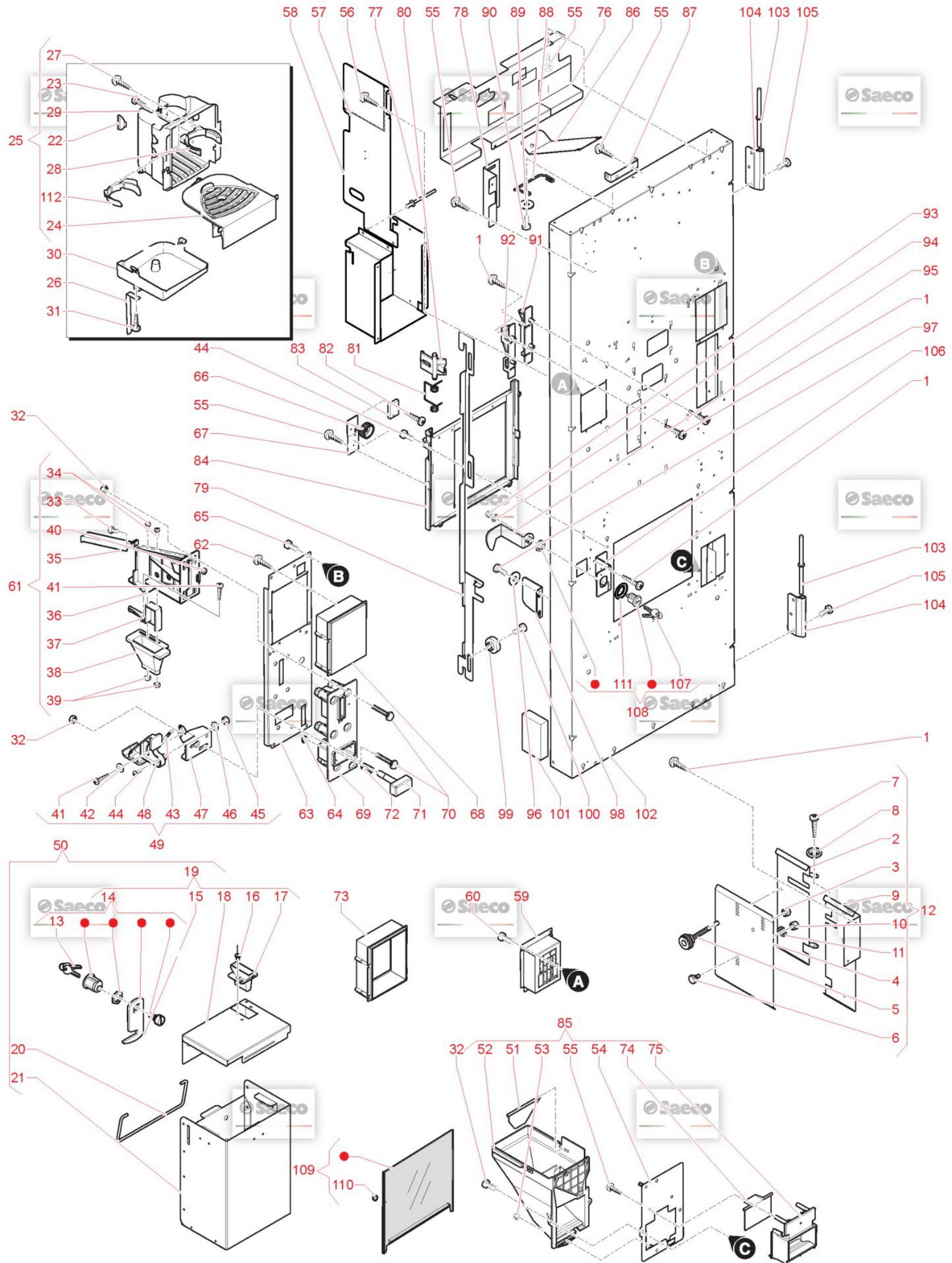

Model Machine

MACSAE304

CRISTALLO 600 EVO 7GPM 1K (10004817)

Web Pos. Foto Item - Replace by Description



Press - CTRL + CLICK go to item in a new window
Натисніть - Ctrl + права кнопка миші щоб відкрити запчастину в новому вікні



1



U044.013

SCREW TSPC M4,0X12 UNI 7688 GALV.
VITE TSPC M4,0X12 UNI 7688 ZNP



1

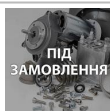

U110.002

SCREW AUT.TCB 3,5X13 DIN 7981F
SCREW AUT.TCB 3,5X13 DIN 7981 F



2

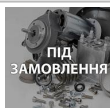

0875.365

SUP.COIN BOX
SUP.COIN BOX



3



123160502

GALVANIZED NUT M5 HIGH UNI 5587-68
GALVANIZED NUT M5 HIGH UNI 5587-68



4

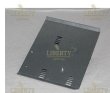

0875.357

ASS.FIXING PLATE COIN BOX
ASS.FIXING PLATE COIN BOX



5

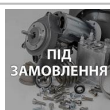

12002033

KNOB D.18 M5X25
KNOB D.18 M5X25



6



9111.614

COIN BOX ANCHORING PIN
COIN BOX ANCHORING PIN



7



U110.005

SCREW AUT.TCB 3,9X9,5 DIN 7981F
VITE AUT.TCB 3,9X9,5 DIN 798



8



1602.147

BUSH FOR DOOR CONNECTING ROD
BUSH FOR DOOR CONNECTING ROD



9

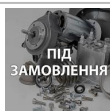

11032971

COIN BOX SUPPORT
COIN BOX SUPPORT



10



123160302

NUT M3 HIGH UNI 5587 GALVANIZED
NUT M3 HIGH UNI 5587 GALVANIZED



11

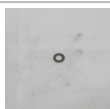

U207.003

PLAIN WASHER 3,2X7 UNI 6592 GALV.
PLAIN WASHER 3,2X7 UNI 6592 GALV.



12

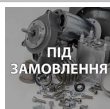











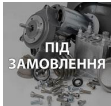



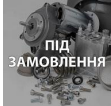



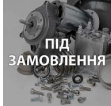

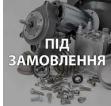

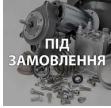

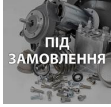

11032973

SUPPORT COIN BOX
ASS.SUPP.GETTONIERA RENDIRESTO FS4N

Model Machine

MACSAE304

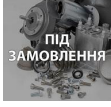















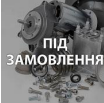





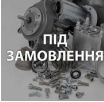

CRISTALLO 600 EVO 7GPM 1K (10004817)

	13		20007333	KEY MERONI 337 <i>KEY MERONI 337</i>
	14		12001902	LOCK MERONI 337 <i>LOCK MERONI 337</i>
	15		11031071	LEVER FOR LOCK <i>LEVER FOR LOCK</i>
	16		NF11.026	EXPANSION RIVET D.3,9X8 ALU. <i>RIVETTO AD ESPANSIONE D.3,9X8 ALL.</i>
	17		11011665	COIN BOX HOPPER <i>COIN BOX HOPPER</i>
	18		11032960	COVER COIN BOX <i>COVER COIN BOX</i>
	19		11032962	COIN BOX CASE LID <i>COIN BOX CASE LID</i>
	20		0875.271	HANDLE FOR COIN CASE <i>HANDLE FOR COIN CASE</i>
	21		11032967	MONEY BOX ASSEMBLY <i>MONEY BOX ASSEMBLY</i>
	22		1863.013	LENS FOR COMPARTMENT DISPENSER <i>LENTE X VANO EROGAZIONE</i>
	23		U019.005	STEI SCREW M5,0X10 UNI 5923 GALV. <i>VITE STEI M5,0X10 UNI 5923 Z</i>
	24		11032880	FS4N GRILL <i>FS4N GRILL</i>
	25		11032969	DISPENSING COMPARTMENT FS4N <i>DISPENSING COMPARTMENT FS4N</i>
	25		11034874	DISPENSING COMPARTMENT CRS EVO D.80 <i>ASS.VANO EROGAZIONE CRS EVO D.80</i>

Model Machine

MACSAE304



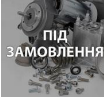



















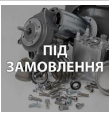

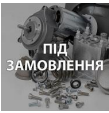

CRISTALLO 600 EVO 7GPM 1K (10004817)

	26		1863.024	STIRRUP FOR COMPARTMENT DISPENSER STAFFA X VANO EROGATORE
	27		U109.022	SCREW AUT.TCB 4,2X13 DIN 7981C SCREW AUT.TCB 4,2X13 DIN 7981 C
	28		9111.368.050	VARIABLE CUP SUPPORT BLACK SUPPORTO BICCHIERE VARIABILE
	29	 ПІД ЗАМОВЛЕННЯ	11027365	COMPARTMENT DISPENSER MILLED COMPARTMENT DISPENSER MILLED
	29	 ПІД ЗАМОВЛЕННЯ	1863.012.050	COMPARTMENT DISPENSER VANO EROGAZIONE
	30		1863.023.050	WATER DRIP TRAY VASCA X VANO EROGAZIONE
	31		U109.023	SCREW AUT.TCB 4,2X9,5 DIN 7981C SCREW AUT.TCB 4,2X9,5 DIN 7981 C
	32	 ПІД ЗАМОВЛЕННЯ	U324.003	NUT M5 FLANGED INDENTED BASE NUT M5 FLANGED INDENTED BASE
	33		U043.007	SCREW TCBC M3,0X8 UNI 7687 GALV. SCREW TCBC M3,0X8 UNI 7687 GALV.
	34		12002039	SCREW TCBD TORX 20 M4X12 ZN-B VITE TCBD TORX 20 M4X12 ZN-B
	35		11011663	SLIDE COVER COIN SLIDE COVER COIN
	36		11011616	COIN CHUTE COIN CHUTE
	37	 ПІД ЗАМОВЛЕННЯ	11011618	БЛОК ДЛЯ КОНВЕЄРА МОНЕТ BLOCCO X CONVOGLIATORE MONETE REGOLABILE

Model Machine

MACSAE304

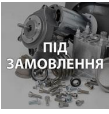









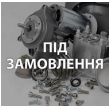















CRISTALLO 600 EVO 7ГРМ 1К (10004817)

	38		11012131	COIN CONVEYOR ADJUSTABLE FS400/600 COIN CONVEYOR ADJUSTABLE FS400/600
	39		U302.003	МЕТАЛЕВА ГАЙКА М4 UNI 5588 ZNP DADO ESAGONALE M4 UNI 5588 ZNP
	40		U302.002	NUT HEXAGONAL M3 UNI 5588 NUT HEXAGONAL M3 UNI 5588
	41		U116.005	SCREW AUT.PT TCB 3,0X8 WN 1441 VITE AUT.PT TCB 3,0X8 WN 1441 ZNP
	42		U212.006	WASHER 3,2X11X0,5 ZNP WASHER 3,2X11X0,5 ZNP
	43		9111.397	SPRING FOR TRAY /LEVER COIN RECOVERE MOLLA X BACINELLA/LEVA RECUP
	44	 ПІД ЗАМОВЛЕННЯ	129825002	TCB SCREW M4X20 UNI 7687 ZNP TCB SCREW M4X20 UNI 7687 ZNP
	45		123453102	GALV.SELF LOCK NUT HIGH M4 DIN982 GALV.SELF LOCK NUT HIGH M4 DIN 982
	46	 ПІД ЗАМОВЛЕННЯ	U201.005	PLAIN WASHER 4,3X12 DIN 7349 GAL PLAIN WASHER 4,3X12 DIN 7349 GAL
	47		11011619	SUPPORT LEVER COIN RECOVERY SUPPORT LEVER COIN RECOVERY
	48		11011660	LEVER COIN RECOVERY LEVER COIN RECOVERY
	49		11011615	LEVER ASS. COIN RECOVERY LEVER ASS. COIN RECOVERY
	50	 ПІД ЗАМОВЛЕННЯ	11032968	ASSEMBLY COIN BOX ASSEMBLY COIN BOX
	51		11011662	ADJUSTABLE PLATE ADJUSTABLE PLATE

Model Machine

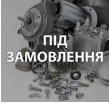
MACSAE304

















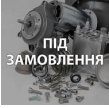





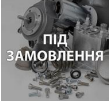

CRISTALLO 600 EVO 7GPM 1K (10004817)

	52		11032793	DUCT COIN RECOVERY FS4N <i>CONDOTTO RECUPERO MONETE FS4N</i>
	53		U324.004	NUT M6 FLANGED INDENTED BASE <i>DADO M6 FLANGIATO BASE DENTELLATA</i>
	54		11033002	COIN RECOVER BRACKET FS4N <i>COIN RECOVER BRACKET FS4N</i>
	55		U110.003	SCREW AUT.TCB 3,5X9,5 DIN 7981F <i>VITE AUT.TCB 3,5X9,5 DIN 798</i>
	56		U110.004	SCREW AUT.TCB 3,5X6,5 DIN 7981F <i>VITE AUT.TCB 3,5X6,5 DIN 7981 F NIK</i>
	57		11033723	COIN BOX BRACKET FS4N <i>PIASTRA PROTEZIONE GETTONIERA FS4N</i>
	58		11033000	COIN BOX BRACKET FS4N <i>PIASTRA SUPP.CASSA MONETE FS4N</i>
	59		11032996	BRACKET FOR BANKNOTE READER <i>BRACKET FOR BANKNOTE READER</i>
	60		U127.011	SCREW TAPT.TCB M5,0X8 DIN 7500C <i>SCREW TAPT.TCB M5,0X8 DIN 7500C</i>
	61		11011614	ASS.SCIVOLO MONETE CRISTALLO400 <i>ASS.SCIVOLO MONETE CRISTALLO400</i>
	62		U142.008	PANELVIT TSP 3,5X12 DIN 7505 AGAL <i>PANELVIT TSP 3,5X12 DIN 7505 A GAL</i>
	63		11032985	PLATE COIN RAMP FS4N <i>PLATE COIN RAMP FS4N</i>
	64		U701.003	SNAP RING 7 UNI 7434 <i>ANELLO ELASTICO 7 UNI 7434</i>
	65		129824002	TCB SCREW M4X10 UNI 7687 ZNP <i>VITE TCB M4X10 UNI 7687 ZNP</i>

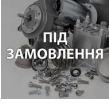
Model Machine

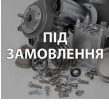
MACSAE304











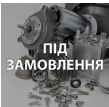















CRISTALLO 600 EVO 7GPM 1K (10004817)

	66		11034002	ASSEMBLY DAMPER+GEAR Z.21 <i>ASSEMBLY DAMPER+GEAR Z.21</i>
	67		11033871	SLOW DOWN BRACKET CRS EVO <i>SLOW DOWN BRACKET CRS EVO</i>
	68		11032946	СЕГМЕНТ БАНКНОТОПРИЙМАЧА FS4N <i>BANKNOTE READER CAP FS4N</i>
	69		11032756	РАМКА ДЛЯ ВСТАВЛЯННЯ МОНЕТ ТА ПІД СІРУ КНОПКУ FS4N <i>CORNICE INTRO.MONETE E TASTO GRY FS4N</i>
	70		U005.018	SCREW TE M5,0X16 UNI 5739 ZNP8.8 <i>VITE TE M5,0X16 UNI 5739 ZNP</i>
	71		11032783	КНОПКА ПОВЕРНЕННЯ МОНЕТ FS4N <i>PUSH BUTTON FS4N</i>
	72		9111.355	SPRING FOR CHANGE BUTTON <i>MOLLA X PULSANTE RENDIRESTO</i>
	73		11032782	BANKNOTE READER FRAME FS4N <i>BANKNOTE READER FRAME FS4N</i>
	74		11032785	CHANGE DOOR FS4N <i>SPORTELLO RENDIRESTO FS4N</i>
	75		11032755	FRAME FOR COIN RECOVERY FS4N <i>FRAME FOR COIN RECOVERY FS4N</i>
	76		11032886	CARD PROTECTION CPU <i>PROTEZIONE SCHEDA CPU</i>
	77		12000962	MULTIGRIP RIVETS 4.8X11 <i>MULTIGRIP RIVETS 4.8X11</i>
	78		11033303	BRACKET TOUCH PANEL <i>BRACKET TOUCH PANEL</i>

Model Machine

MACSAE304

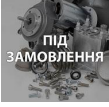

























CRISTALLO 600 EVO 7GPM 1K (10004817)

	79	 ПІД ЗАМОВЛЕННЯ	11034579	ROD FOR LOCK <i>ROD FOR LOCK</i>
	80		9111.372.050	DISP. COMPARTM. LOCKING LEVERBLAC <i>LEVA FERMO VANO EROGAZIONE NERO</i>
	81		9111.373	SPRING FOR DISP. COMP. RETAINING <i>MOLLA X FERMO VANO EROGAZ.</i>
	82	 ПІД ЗАМОВЛЕННЯ	U110.011	SCREW AUT.TCB 2,9X9,5 DIN 7981F <i>SCREW AUT.TCB 2,9X9,5 DIN 7981 F</i>
	83	 ПІД ЗАМОВЛЕННЯ	1863.649	REED FOR DOOR <i>REED FOR DOOR</i>
	84	 ПІД ЗАМОВЛЕННЯ	11032791	DISPENSER VAIN SUPPORT FS4N <i>DISPENSER VAIN SUPPORT FS4N</i>
	85	 ПІД ЗАМОВЛЕННЯ	11033004	COIN REVOOVER ASSEMBLY <i>ASS.RECUPERO MONETE</i>
	86	 ПІД ЗАМОВЛЕННЯ	11033149	COVER GLASSES FRAME FS6N <i>COVER GLASSES FRAME FS6N</i>
	86	 ПІД ЗАМОВЛЕННЯ	11034084	COVER GLASSES D.83 FRAME CRS EVO <i>COVER GLASSES D.83 FRAME CRS EVO</i>
	87	 ПІД ЗАМОВЛЕННЯ	0894.185	BASKET STOP BRACKET <i>BASKET STOP BRACKET</i>
	88	 ПІД ЗАМОВЛЕННЯ	11007640	SPRING FOR UPPER DOOR MICROSWITCH <i>SPRING FOR UPPER DOOR MICROSWITCH</i>
	89		U207.002	PLAIN WASHER 4,3X9 UNI 6592 GAL <i>ROSETTA PIANA 4,3X9 UNI 6592 ZNP</i>
	90	 ПІД ЗАМОВЛЕННЯ	U043.006	SCREW TCBC M4,0X14 UNI 7687 GALV. <i>SCREW TCBC M4,0X14 UNI 7687 GALV.</i>
	91		1863.033.A20	CUP DISTR. SUPPORT <i>SUPPORTO DISTRIBUTORE BICCH.DX</i>

Model Machine

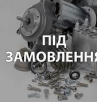
MACSAE304

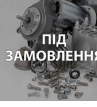









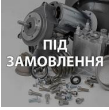

CRISTALLO 600 EVO 7GPM 1K (10004817)

	92		1863.032.A20	CUP DISTR. SUPPORT <i>SUPPORTO DISTRIBUTORE BICCH.SX</i>
	93		U302.006	NUT HEXAGONAL M10 UNI 5588 <i>DADO ESAGONALE M10 UNI 5</i>
	94		U208.008	TOOTHED WASHER 10,5X18 UNI 3703 G <i>ROSETTA DENT. 10,5X18 UNI 3</i>
	95		11034580	LEVER LOCK <i>LEVER LOCK</i>
	96		U207.001	PLAIN WASHER 5,3X10 UNI 6592 GAL <i>ROSETTA PIANA 5,3X10 UNI 6</i>
	97		U043.015	SCREW TCBC M5,0X12 UNI 7687 GALV. <i>SCREW TCBC M5,0X12 UNI 7687 GALV.</i>
	98		11003448	MOVABLE PLATE FOR FS400 DOOR <i>MOVABLE PLATE FOR FS400 DOOR</i>
	99		11008644	LOCK PIN <i>LOCK PIN</i>
	10001		U046.001	SCREW TEFZ M5,0X16 UNI 6921 GALV. <i>SCREW TEFZ M5,0X16 UNI 6921 GALV.</i>
	1010		11000390	OUTDISTANCE FOR FS400 DOOR <i>OUTDISTANCE FOR FS400 DOOR</i>
	1020		11033154	ASSEMBLY FRONT DOOR FS6N <i>ASS.PORTA ANTERIORE RIVETTATA FS6N</i>
	1030		11032805	PIN HINGE FS4N <i>PERNO CERNIERA FS4N</i>
	1040		11033875	LOWER DOOR CRS EVO BLK <i>CERNIERA PORTA CRS EVO BLK</i>
	1050		U044.002	SCREW TSPC M4,0X10 UNI 7688 GALV. <i>SCREW TSPC M4,0X10 UNI 7688 GALV.</i>

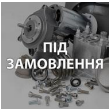
Model Machine

MACSAE304

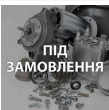
CRISTALLO 600 EVO 7GPM 1K (10004817)

	1060	 ПІД ЗАМОВЛЕННЯ	11032998	BRACKET FOR LOCK <i>PIASTRA SUPP.SERRATURA FS4N</i>
	1070		NV02.243	KEY RIELDA AJ306A <i>KEY RIELDA AJ306A</i>
	1080		NV02.229	LOCK RIELDA MOD.512 + KEY <i>LOCK RIELDA MOD.512 + KEY</i>
	1090	 ПІД ЗАМОВЛЕННЯ	11033747	CUP STATION'S DOOR <i>CUP STATION'S DOOR</i>
	1100		9991.093	MAGNET D=9,5 X H=1,5 <i>MAGNETE D.9,5 X 1,5</i>
	1110	 ПІД ЗАМОВЛЕННЯ	11014166	LOCK BUSH <i>LOCK BUSH</i>
	1120		11027722	CUP SUPPORT D.83 <i>CUP SUPPORT D.83</i>

Model Machine

MACSAE304

CRISTALLO 600 EVO 7FPM 1K (10004817)

MACSAE304.T.0004

TAVOLA NR. 4 - ARTICOLO CRISTALLO 600 EVO 7FPM 1K (10004817)

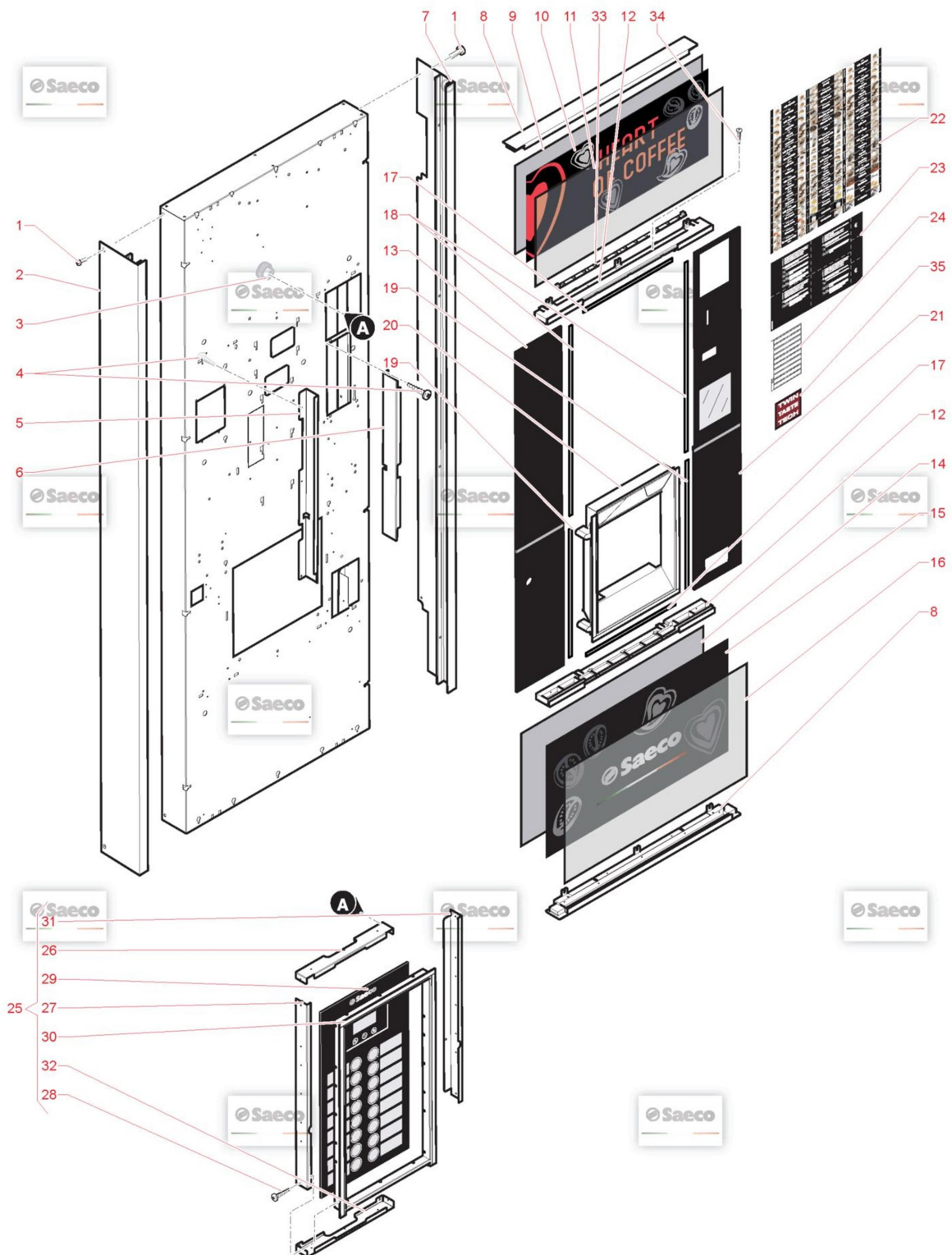

Model Machine

MACSAE304

CRISTALLO 600 EVO 7GPM 1K (10004817)

Web Pos. Foto Item - Replace by Description



Press - CTRL + CLICK go to item in a new window

Натисніть - Ctrl + права кнопка миші щоб відкрити запчастину в новому вікні



2

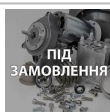

11033143

LEFT OUTLINE SIDE FS6N
PROFILO LATERALE SX ALLUMINIO FS6N



2

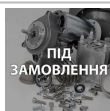

11034111

PROFILE SIDE LX CRS600 EVO SILVER
PROFILE SIDE LX CRS600 EVO SILVER



3



12002034

KNOB WITH BUSH M5
KNOB WITH BUSH M5



4

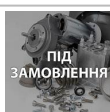

U110.003

SCREW AUT.TCB 3,5X9,5 DIN 7981F
VITE AUT.TCB 3,5X9,5 DIN 798



5

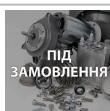

11032978

LEFT TRACK FOR LEXAN FS4N
LEFT TRACK FOR LEXAN FS4N



6

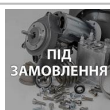

11032976

RIGHT TRACK FOR LEXAN FS4N
RIGHT TRACK FOR LEXAN FS4N



7

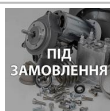

11033142

RIGHT OUTLINE SIDE FS6N
PROFILO LATERALE DX ALLUMINIO FS6N



7

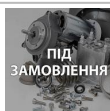

11034109

PROFILE SIDE RX CRS600 EVO
PROFILE SIDE RX CRS600 EVO



8

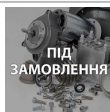

11032788

UPPER/LOWER OUTLINE FSN4
UPPER/LOWER OUTLINE FSN4



9

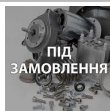

11033818

UPPER LEXAN CRS400 EVO
LEXAN SUPERIORE OPALINO CRS400 EVO



9

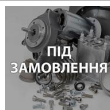

11033819

UPPER LEXAN CRS600 EVO
UPPER LEXAN CRS600 EVO



10

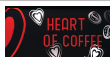

11033140

ВЕРХНЯ КАРТИНКИ CRISTALLO600 EVO
UPPER IMAGE CRISTALLO600 EVO



10

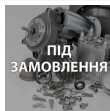











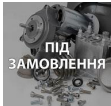

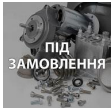

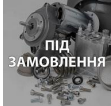



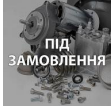

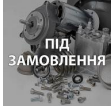

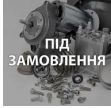

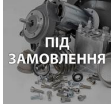

11033371

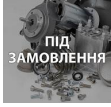
UPPER ADVERTISING CRISTALLO600EVO CAPS
UPPER ADVERTISING CRISTALLO600EVO CAPS

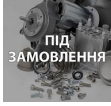
Model Machine

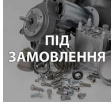
MACSAE304

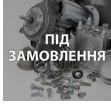















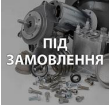





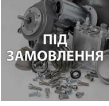

CRISTALLO 600 EVO 7GPM 1K (10004817)

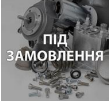
	10		11034502	UPPER IMAGE CRS400 EVO WHITE <i>UPPER IMAGE CRS400 EVO WHITE</i>
	10		11034507	UPPER IMAGE CRS600 EVO CAPS COVIM <i>UPPER IMAGE CRS600 EVO CAPS COVIM</i>
	10		20007552	LEXAN UPPER CRS 600 EVO PROXIPAUSE <i>LEXAN UPPER CRS 600 EVO PROXIPAUSE</i>
	11		11032795	ПЕРЕДНЯ ПАНЕЛЬ ПРОЗОРА FS4N <i>LEXAN SUPERIORE FS4N</i>
	12		11032787	CENTRAL OUTLINE FS4N <i>CENTRAL OUTLINE FS4N</i>
	13		11032797	LEFT SIDE LEXAN FS4N <i>LEXAN LATERALE SX FS4N</i>
	14		11033817	LOWER LEXAN CRS EVO <i>LOWER LEXAN CRS EVO</i>
	15		11033369	LOWER ADVERTISING PLATE CRISTALLO EVO <i>TARGA INFERIORE CRISTALLO EVO CAPS</i>
	15		11033784	LOWER IMAGE CRS H.342 <i>LOWER IMAGE CRS H.342</i>
	15		11034329	LOWER IMAGE CRS EVO CAPS COVIMITA <i>LOWER IMAGE CRS EVO CAPS COVIM ITA</i>
	15		11034335	LOWER IMAGE CRS EVO CAPS CAFFITALY <i>LOWER IMAGE CRS EVO CAPS CAFFITALY</i>
	15		11034503	LOWER IMAGE CRS EVO WHITE <i>LOWER IMAGE CRS EVO WHITE</i>
	15		11034506	LOWER IMAGE CRS EVO CAPS COVIMFRA <i>LOWER IMAGE CRS EVO CAPS COVIMFRA</i>
	15		20007550	LEXAN LOWER CRS EVO PROXI PAUSE <i>LEXAN LOWER CRS EVO PROXI PAUSE</i>

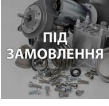
Model Machine

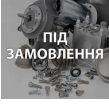
MACSAE304











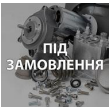

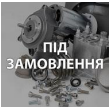

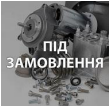











CRISTALLO 600 EVO 7GPM 1K (10004817)

	16		11032796	LOWER LEXAN CRS EVO <i>LEXAN INFERIORE CRS EVO</i>
	17		11033293	STICKY FILLET 291,1 X 9,5 X 0,8 <i>STICKY FILLET 291,1 X 9,5 X 0,8</i>
	18		11033295	STICKY FILLET 506,8 X 9,5 X 0,8 <i>STICKY FILLET 506,8 X 9,5 X 0,8</i>
	19		11033294	STICKY FILLET 354,3 X 9,5 X 0,8 <i>STICKY FILLET 354,3 X 9,5 X 0,8</i>
	20		11032790	DISPENSER FRAME VAIN FS4N <i>CORNICE VANO EROGAZIONE FS4N</i>
	21		11033810	RIGHT SIDE LEXAN CRS400 EVO <i>LEXAN LATERALE DX CRS400 EVO</i>
	22		15004381	ТАБЛИЧКА З НАЗВАМИ НАПОЇВ ІТА <i>FOGLIO ETICH.PROD.TAST.CAPACITIVA ITA</i>
	22		15004382	PRODUCTS LABEL'S SHEET CRISTALLO EVO ENG <i>PRODUCTS LABEL'S SHEET CRISTALLO EVO ENG</i>
	22		15004383	PRODUCTS LABEL'S SHEET CRISTALLO EVO FRA <i>PRODUCTS LABEL'S SHEET CRISTALLO EVO FRA</i>
	22		15004384	PRODUCTS LABEL'S SHEET CRISTALLO EVO DE <i>PRODUCTS LABEL'S SHEET CRISTALLO EVO DE</i>
	22		15004385	PRODUCTS LABEL'S SHEET CRISTALLO EVO SPA <i>PRODUCTS LABEL'S SHEET CRISTALLO EVO SPA</i>
	22		15004386	PRODUCTS LABEL'S SHEET CRISTALLO EVO POR <i>FOGLIO ETICH.PROD.TAST.CAPACITIVA POR</i>
	22		15004387	PRODUCTS LABEL'S SHEET CRISTALLO EVO NL <i>PRODUCTS LABEL'S SHEET CRISTALLO EVO NL</i>

Model Machine

MACSAE304

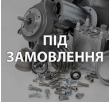





















CRISTALLO 600 EVO 7GPM 1K (10004817)

	22		15004540	PRODUCTS LABEL'S SHEET CRS EVOITA <i>PRODUCTS LABEL'S SHEET CRS EVOITA</i>
	22		15004611	PRODUCTS LABEL'S SHEET CRS EVOCOVIM FRA <i>PRODUCTS LABEL'S SHEET CRS EVO COVIM FRA</i>
	22		15004612	PRODUCTS LABEL'S SHEET CRS EVOCOVIM SPA <i>PRODUCTS LABEL'S SHEET CRS EVOCOVIM SPA</i>
	22		15004613	PRODUCTS LABEL'S SHEET CRS EVOCOVIM POR <i>PRODUCTS LABEL'S SHEET CRS EVOCOVIM POR</i>
	22		15004670	ADD.LABEL'S SHEET CAPACITIVE KEYBOARD <i>ADD.LABEL'S SHEET CAPACITIVE KEYBOARD</i>
	22		21002400	PRODUCTS LABEL'S SHEET CRS EVOPP FRA <i>PRODUCTS LABEL'S SHEET CRS EVOPP FRA</i>
	23		15004037	INSTRUCTION LABEL CRISTALLO C.B ITA <i>INSTRUCTION LABEL CRISTALLO C.B ITA</i>
	23		15004038	INSTRUCTION LABEL CRISTALLO C.B FRA <i>INSTRUCTION LABEL CRISTALLO C.B FRA</i>
	23		15004039	INSTRUCTION LABEL CRISTALLO C.B DE <i>INSTRUCTION LABEL CRISTALLO C.B DE</i>
	23		15004040	INSTRUCTION LABEL CRISTALLO C.B POR <i>INSTRUCTION LABEL CRISTALLO C.B POR</i>
	23		15004041	INSTRUCTION LABEL CRISTALLO C.B ESP <i>INSTRUCTION LABEL CRISTALLO C.B ESP</i>
	23		15004042	INSTRUCTION LABEL CRISTALLO C.B NL <i>INSTRUCTION LABEL CRISTALLO C.B NL</i>
	23		15004043	INSTRUCTION LABEL CRISTALLO C.B ENG <i>INSTRUCTION LABEL CRISTALLO C.B ENG</i>
	24		0775.989	PRICE LABELS WHITE EURO <i>PRICE LABELS WHITE EURO</i>

Model Machine

MACSAE304

CRISTALLO 600 EVO 7GPM 1K (10004817)

	25		11032874	CAPACITIVE INTERFACE <i>CAPACITIVE INTERFACE</i>
	26		11032866	UPPER ANGULAR FRAME <i>UPPER ANGULAR FRAME</i>
	27		11032862	LEFT ANGULAR FRAME <i>LEFT ANGULAR FRAME</i>
	28		12002160	SCREW TMTPH2 3,5X9,5 F ZNP ISO4759/1 <i>SCREW TMTPH2 3,5X9,5 F ZNP ISO4759/1</i>
	29		11032867	CAPACITIVE KEYBOARD <i>CAPACITIVE KEYBOARD</i>
	30		11032789	INTERFACE FRAME FS4N <i>INTERFACE FRAME FS4N</i>
	31		11032861	RIGHT ANGULAR FRAME <i>RIGHT ANGULAR FRAME</i>
	32		11032863	LOWER ANGULAR FRAME <i>LOWER ANGULAR FRAME</i>
	33		11031810	400MM LED BOARD <i>400 MM LED BOARD</i>
	34		U110.011	SCREW AUT.TCB 2,9X9,5 DIN 7981F <i>SCREW AUT.TCB 2,9X9,5 DIN 7981 F</i>
	35		15002044	LABEL TWIN TASTE TECH GREY <i>LABEL TWIN TASTE TECH GREY</i>

Model Machine

MACSAE304

CRISTALLO 600 EVO 7GPM 1K (10004817)

MACSAE304.T.0005



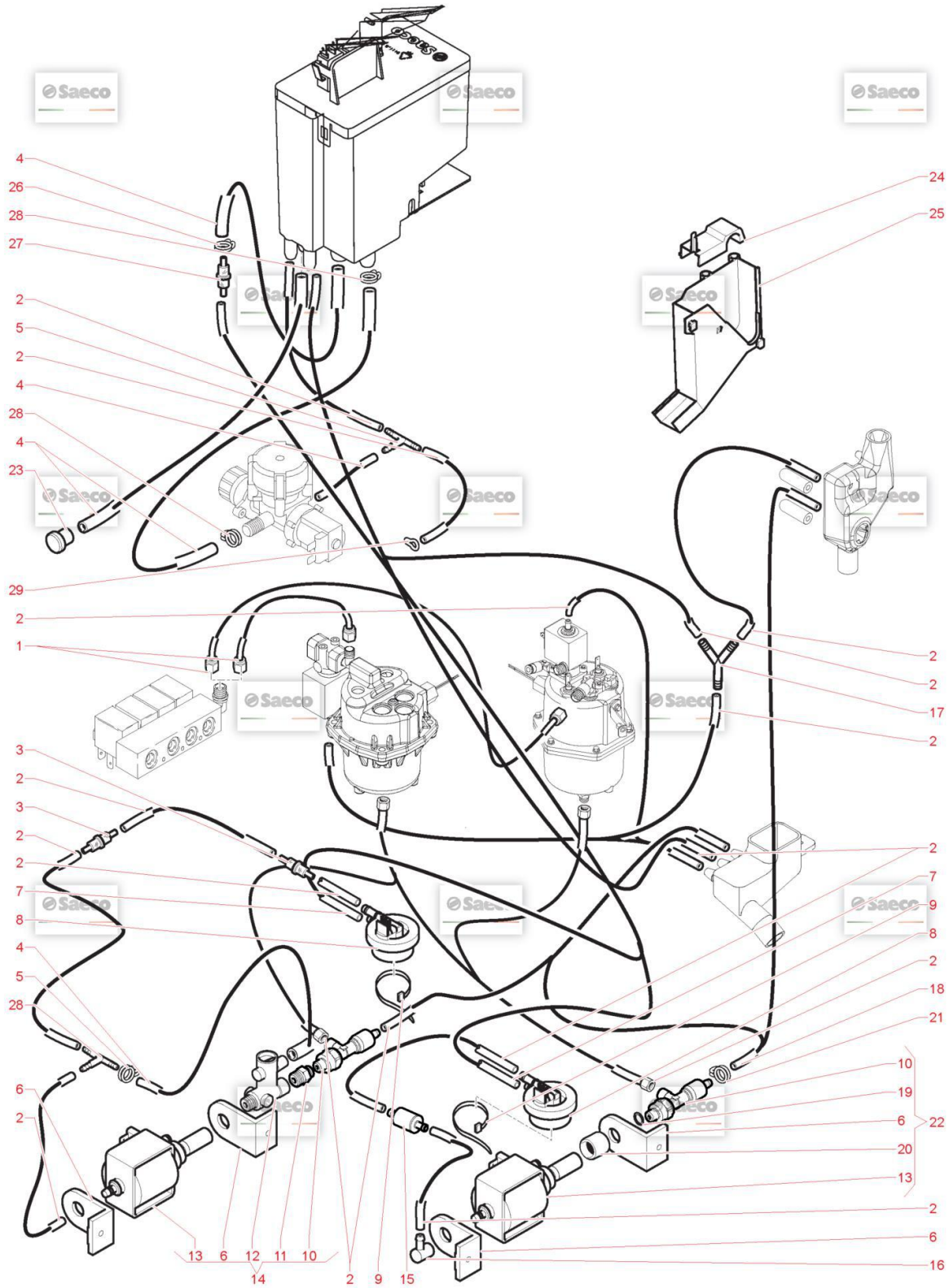























TAVOLA NR. 5 - ARTICOLO CRISTALLO 600 EVO 7GPM 1K (10004817)

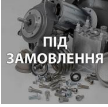

Model Machine

MACSAE304











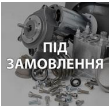















CRISTALLO 600 EVO 7GPM 1K (10004817)

Web	Pos.	Foto	Item - Replace by	Description
				<i>Press - CTRL + CLICK go to item in a new window Натисніть - Ctrl + права кнопка миші щоб відкрити запчастину в новому вікні</i>
	1		11025295	TEFLON TUBE 3X6 L.170 1/8"-1/8 TEFLON TUBE 3X6 L.170 1/8-1/8
	2	 ПІД ЗАМОВЛЕННЯ	9972.246	СИЛІКОНОВА ТРУБКА 5X10 SAECO 265918 (2 МЕТРИ) TUBO SILICONE 5X10 L.2000 MM
	3		11032038	FILTER INTAKE IN LUNG WATER SUPPLY FILTRO POLMONE IN ASPIRAZ.RETE IDRICA
	4		9972.055	ТРУБКА СИЛІКОНОВА 8X12 2 МЕТРИ SILICONE TUBE 8X12 L.2000MM
	5		NV99.004	CONNECTOR T MORONI 8026047 D=8 CONNECTOR T MORONI 8026047 D=8
	6		149185850	ТРИМАЧ (ГУМОВИЙ)ПОМПИ ДЛЯ КАВОМАШИН SAECO MAGIC 4002012 (...) SUPPORTO POMPA EATON MAGIC 4
	7		9972.057	КОРИЧНЕВА ГУМОВА ТРУБКА 5X8 2 МЕТРИ TUBO SILICONE MARRON 5X8 L.2000 MM
	8		NV99.099	TURBINE D=1,2 ASSY. TURBINA DIGMESA FHKSC 1,2 ARNITE OC
	9	 ПІД ЗАМОВЛЕННЯ	144320200	SELF LOCK STRIP W=2.6 L=200 SELF LOCK STRIP W=2.6 L=200
	10		11005590	SAFETY VALVE/NON RETURN ASS. NEW ASS.VALVOLA SICUREZZA/NON RI
	11		11032615	FITTING ADAPTER VALVE FITTING ADAPTER VALVE
	12		20007360	ОБХІДНИЙ КЛАПАН FLUID-O-TECH B7E BYPASS VALVE FLUID-O-TECH B7E
	13	 ПІД ЗАМОВЛЕННЯ	9070.034.00A	POMPE ULKA EP7 POMPA ULKA EP7 230V

Model Machine

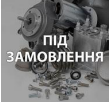
MACSAE304















CRISTALLO 600 EVO 7GPM 1K (10004817)

	13		9070.034.00F	ULKA PUMP EP7 120V <i>ULKA PUMP EP7 120V</i>
	13		9070.042.00A	ULKA HACOC (ПОМПА) EX5GW 230/240V 50HZ SD1 БЬЯНКО 15 BAR <i>ULKA PUMP EX5 SD1</i>
	14		11033578	ASSMEBLY PUMP EX5 SD1 230V <i>ASSMEBLY PUMP EX5 SD1 230V</i>
	15		11024178	WATER FILTER PHEDRA <i>WATER FILTER PHEDRA</i>
	16		147920150	90° INLET PUMP CONNECTOR <i>RACCORDO A 90° IN SANTOPRENE</i>
	17		147920800	Y CONNECTOR D=8 ART.80.26.048KA.466 <i>RACCORDO Y D=8 ART.80.26.048 KA.466</i>
	18		11025292	TEFLON TUBE 3X6 L.230 1/8"-1/8 <i>TEFLON TUBE 3X6 L.230 1/8"-1/8</i>
	18		11025297	TEFLON TUBE 3X6 L.310 1/8"-1/8 <i>TEFLON TUBE 3X6 L.310 1/8"-1/8</i>
	19		140321961	ПРОКЛАДКА O-RING ДЛЯ КАВОМАШИНИ SAECO 2031 TERMOIL <i>OR 2031 IN TERMOIL</i>
	20		9071.098	REINFORCEMENT FOR ULKA PUMP <i>REINFORCEMENT FOR ULKA PUMP</i>
	21		NV99.077	ЗАЖИМНА СТЯЖКА D=9,8/10,6 1 .6 PHILIPS SAECO 996530069882 <i>FASCETTA STRINGITUBO D=9,8/10,6</i>
	22		11012024	ULKA PUMP ASS. EP7 120/60 CR600TTT UL <i>ULKA PUMP ASS. EP7 120/60 CR600TTT UL</i>
	22		11012179	ULKA PUMP ASS. EP7 230/50 CR600TTT <i>ULKA PUMP ASS. EP7 230/50 CR600TTT</i>
	22		9070.043.00A	ULKA PUMP+NON RETURN <i>ULKA PUMP EX5 SD1 +NON RETURN</i>

Model Machine

MACSAE304

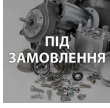
CRISTALLO 600 EVO 7GPM 1K (10004817)

	23		NV03.006	CAP KAPSTO LPN 615/010 <i>TAPPO KAPSTO LPN 615/010</i>
	24		9161.262.060	DRIP CHANNEL COVER <i>COPERTURA CANALINO RACCOGLIGOCCE</i>
	25		9111.597.050	COFFEE DISCHARGE CHANNEL SHORT <i>CANALINO SCARICO CAFFE' CORTO</i>
	26		NV99.072	HOSE CLAMP D. 11.6/12.3 <i>HOSE CLAMP D. 11.6/12.3</i>
	27		144650300	ФІЛЬТР ОЧИСТКИ ВОДИ ДЛЯ КАВОМАШИНИ SAECO NEW (NV99.001) (88... <i>ASPIRATION FILTER GAUZE NET 500 (NEW)</i>
	28		NV99.050	HOSECLAMP D. 13.3/14.1 <i>HOSECLAMP D. 13.3/14.1</i>
	28		NV99.087	BAND D=11/11,6 <i>BAND D=11/11,6</i>
	29		9111.141	DISCHARGE TUBE CLOSURE SPRING <i>DISCHARGE TUBE CLOSURE SPRING</i>

Model Machine

MACSAE304

CRISTALLO 600 EVO 7FPM 1K (10004817)

MACSAE304.T.0006

TAVOLA NR. 6 - ARTICOLO CRISTALLO 600 EVO 7FPM 1K (10004817)

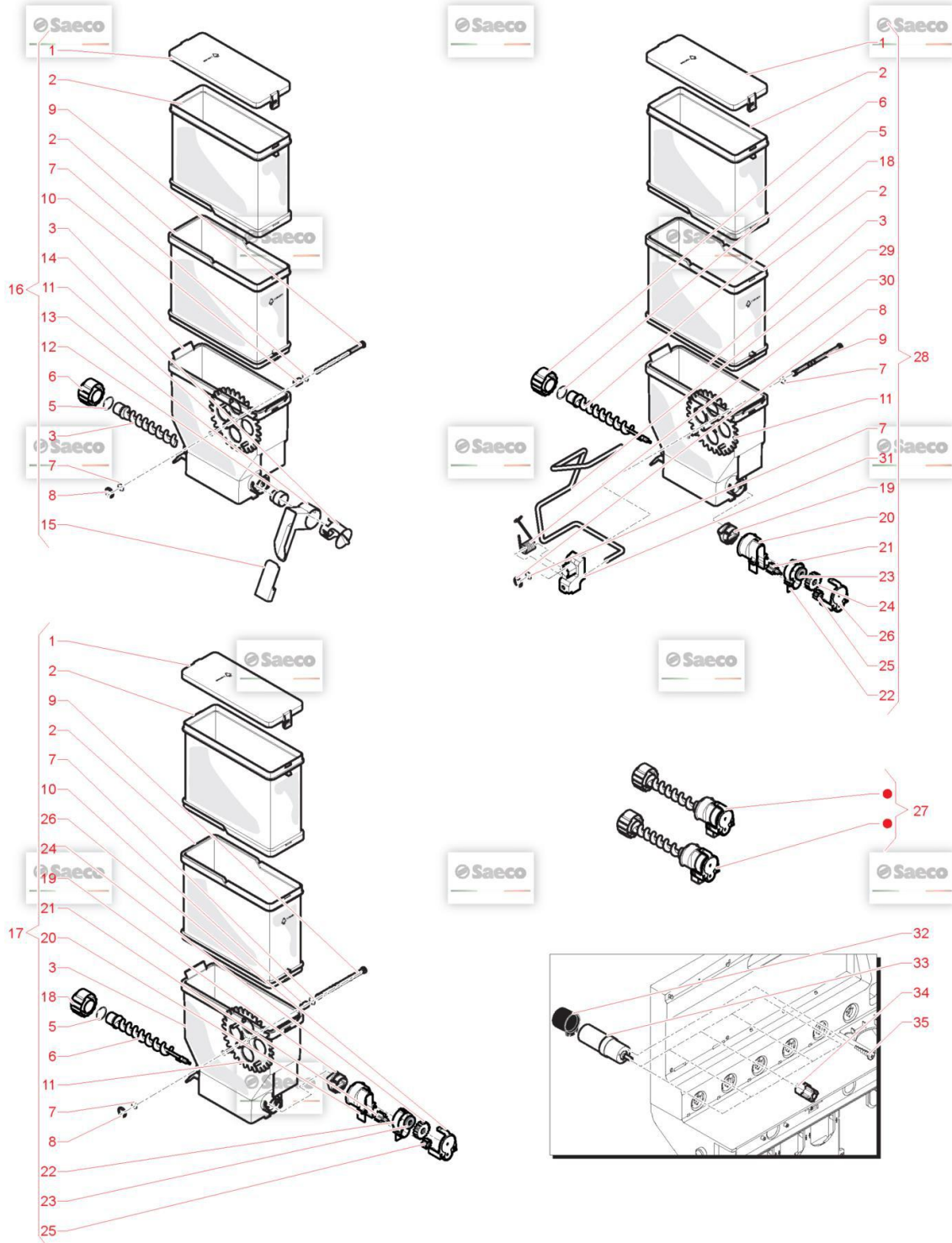

Model Machine

MACSAE304

CRISTALLO 600 EVO 7GPM 1K (10004817)

Web Pos. Foto Item - Replace by Description



Press - CTRL + CLICK go to item in a new window
Натисніть - Ctrl + права кнопка миші щоб відкрити запчастину в новому вікні



1



11001578

COVER CONTAINER SINGLE SOLUBLE
COPERCHIO CONTENITORE SOLUBILE SINGOLO



2



11001577

EXTENSION CONTAINER SINGLE SOLUBLE
PROLUNGA CONTENITORE SOLUBILE SINGOLO



3



11001576

BASE CONTAINER SINGLE SOLUBLE
BASE CONTENITORE SOLUBILE SINGOLO



4



11001658

SCROLL SCREW
COCLEA PER DEVIATORE



5



NM03.013

OR 2,3X15 NBR
OR 2,3X15 NBR



6



11012130

BACK BUSH REINFORCE
BACK BUSH REINFORCE



7



NM03.022

OR ORM 0060-10 NBR
OR ORM 0060-10 NBR



8



U701.003

SNAP RING 7 UNI 7434
ANELLO ELASTICO 7 UNI 7434



9



11001580

PIN WHEEL CONTAINER SINGLE SOLUBLE
PERNO RUOTA DENTATA CONT.SOLUB.SINGOLO



10



11032945

SPACE FOR GEAR BPA FREE
SPACE FOR GEAR BPA FREE



11



9111.702

WHEEL DOUBLE CONTAINER
RUOTA CONTENITORE DOPPIO



12



11001654

BUSH CONTAINER
BOCCOLA CONTENITORE



13































9111.425.060

POWDER DUCT
CONDOTTO POLVERE ORIENTABILE

Model Machine

MACSAE304



















CRISTALLO 600 EVO 7GPM 1K (10004817)

	14		9111.457.060	BUSH FOR LEFT/RIGHT DUCT COSMEC <i>BOCCOLA X CONDOTTO DX-SX COSMEC</i>
	15		9111.428.060	PLUG FOR LEFT-RIGHT DUCT <i>TAPPO X CONDOTTO DX-SX</i>
	16		11004505	ASSEMBLY SINGLE CONTAINER W/SWITCH <i>ASS.MONTATO CONT.SINGOLO C/DEVIATORE</i>
	17		11031883	ASSEMBLY SINGLE CONTAINER <i>ASSEMBLY SINGL CONTAINER</i>
	18		11005180	SCROLL SCREW FOR NEW DISPENSER APERTURE <i>COCLEA X BOCCHETTA EROGAZIONE APERTURE SCROLL SCREW FOR ...</i>
	19		11028378	FRONT BUSH <i>FRONT BUSH</i>
	20		11031678	EASY DRY DISPENSER APERTURE <i>EASY DRY DISPENSER APERTURE</i>
	21		11031679	DISPENSER FAN EASY DRY <i>DISPENSER FAN EASY DRY</i>
	22		11031691	CARTER FOR GEAR EASY DRY <i>CARTER FOR GEAR EASY DRY</i>
	23		11031692	FELT RING DE=47,4 DI=41,4H=4 <i>FELT RING DE=47,4 DI=41,4H=4</i>
	24		11031690	WHEEL Z=18 EASY DRY <i>WHEEL Z=18 EASY DRY</i>
	25		11005182	WHEEL Z=9 <i>WHEEL Z=9</i>
	26		11005168	LID CARTER GEAR <i>LID CARTER GEAR</i>
	27		21001290	KIT NEW POWDER DISPENSING SYSTEM <i>KIT NEW POWDER DISPENSING SYSTEM</i>

Model Machine

MACSAE304

CRISTALLO 600 EVO 7GPM 1K (10004817)

	28		11031886	ASSEMBLY SINGLE CONTAINER <i>ASSEMBLY SINGLE CONTAINER</i>
	29		11006124	WIRE AGITATOR UNIFIED <i>FILO AGITATORE UNIFICATO WIRE AGITATOR UNIFIED</i>
	30		9111.731	SPRING <i>MOLLA AGITATORE</i>
	31		11007155	ПЛАСТИКОВИЙ ТРИМАЧ ВЗБИВАЛКИ SAECO 9111.735 <i>AGITATOR SUPPORT</i>
	32		9121.155	HOOD FOR RATIOMOTOR <i>CUFFIA X MOTORIDUTTORE</i>
	33		9121.106.00P	SUGAR RATIOMOTOR 24V DC <i>MOTORIDUTTORE ZUCCHERO 24V D.C.</i>
	34		9111.131	COUPLING FOR SOLUBLES MOTOR <i>GIUNTO X MOTORE SOLUBILI</i>
	35		U116.003	SCREW AUT.PT TCB 3,0X12 WN 1441 <i>VITE AUT.PT TCB 3,0X12 WN 1441 ZNP</i>
	35		U116.005	SCREW AUT.PT TCB 3,0X8 WN 1441 <i>VITE AUT.PT TCB 3,0X8 WN 1441 ZNP</i>

Model Machine

MACSAE304

CRISTALLO 600 EVO 7FPM 1K (10004817)

MACSAE304.T.0007

TAVOLA NR. 7 - ARTICOLO CRISTALLO 600 EVO 7FPM 1K (10004817)

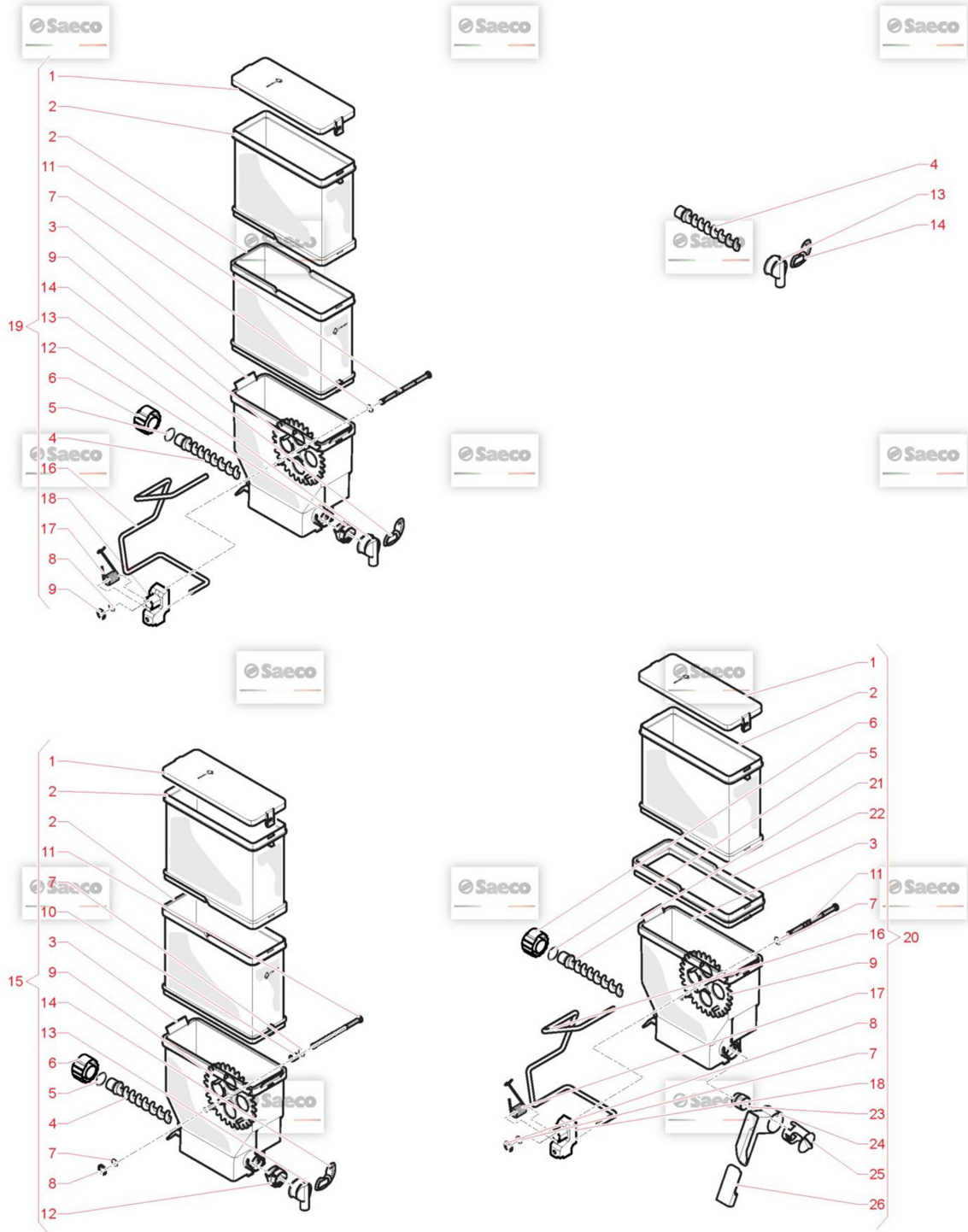

Model Machine

MACSAE304

CRISTALLO 600 EVO 7GPM 1K (10004817)

Web Pos. Foto Item - Replace by Description



Press - CTRL + CLICK go to item in a new window
Натисніть - Ctrl + права кнопка миші щоб відкрити запчастину в новому вікні



1



11001578

COVER CONTAINER SINGLE SOLUBLE
COPERCHIO CONTENITORE SOLUBILE SINGOLO



2



11001577

EXTENSION CONTAINER SINGLE SOLUBLE
PROLUNGA CONTENITORE SOLUBILE SINGOLO



3



11001576

BASE CONTAINER SINGLE SOLUBLE
BASE CONTENITORE SOLUBILE SINGOLO



4



9111.701

SCROLL SCREW DOUBLE CONTAINER
COCLEA CONTENITORE DOPPIO



5



NM03.013

OR 2,3X15 NBR
OR 2,3X15 NBR



6



11012130

BACK BUSH REINFORCE
BACK BUSH REINFORCE



7



NM03.022

OR ORM 0060-10 NBR
OR ORM 0060-10 NBR



8



U701.003

SNAP RING 7 UNI 7434
ANELLO ELASTICO 7 UNI 7434



9



9111.702

WHEEL DOUBLE CONTAINER
RUOTA CONTENITORE DOPPIO



10



11032945

SPACE FOR GEAR BPA FREE
SPACE FOR GEAR BPA FREE



11



11001580

PIN WHEEL CONTAINER SINGLE SOLUBLE
PERNO RUOTA DENTATA CONT.SOLUB.SINGOLO



12



9111.630.060

BUSH FOR POWDERS TANK
BOCCOLA X SERBAT.POLVERI C/AGGANCI



13





















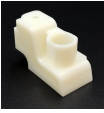

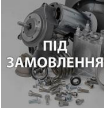

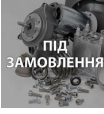

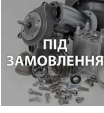

9111.629.060

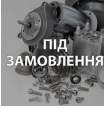
APERTURE FOR SOLUBLES HOPPER
APERTURE FOR SOLUBLES HOPPER

Model Machine

MACSAE304

CRISTALLO 600 EVO 7GPM 1K (10004817)

	14		9111.338.270	BULKHEAD FOR APERT. CLOSURE ORANGE <i>PARATIA CHIUSURA BOCCHETTA ARANCIO</i>
	15		11026696	ASSEMBLY SINGLE CONTAINER <i>ASS.MONT.CONTENITORE SINGOLO</i>
	16		11006124	WIRE AGITATOR UNIFIED <i>FILO AGITATORE UNIFICATO WIRE AGITATOR UNIFIED</i>
	17		9111.731	SPRING <i>MOLLA AGITATORE</i>
	18		11007155	ПЛАСТИКОВИЙ ТРИМАЧ ВЗБИВАЛКИ SAECO 9111.735 <i>AGITATOR SUPPORT</i>
	19	 ПІД ЗАМОВЛЕННЯ	11006123	ASSEMBLY SINGLE CONTAINER WITHAGITATOR <i>ASS.MONT.CONTENITORE SINGOLO C/AGITATORE</i>
	19	 ПІД ЗАМОВЛЕННЯ	11031640	ASSEMBLY SINGLE CONTAINER WITHAGITATOR <i>ASSEMBLY SINGLE CONTAINER WITH AGITATOR</i>
	20	 ПІД ЗАМОВЛЕННЯ	11032718	ASSEMBLY SINGLE CONTAINER H.350 <i>ASSEMBLY SINGLE CONTAINER H.350</i>
	21		11001658	SCROLL SCREW <i>COCLEA PER DEVIATORE</i>
	22	 ПІД ЗАМОВЛЕННЯ	11032119	ADAPTER FOR EXTENSION CONTAINER SOLUBLE <i>ADAPTER FOR EXTENSION CONTAINER SOLUBLE</i>
	23		11001654	BUSH CONTAINER <i>BOCCOLA CONTENITORE</i>
	24		9111.425.060	POWDER DUCT <i>CONDOTTO POLVERE ORIENTABILE</i>
	25		9111.457.060	BUSH FOR LEFT/RIGHT DUCT COSMEC <i>BOCCOLA X CONDOTTO DX-SX COSMEC</i>
	26		9111.428.060	PLUG FOR LEFT-RIGHT DUCT <i>TAPPO X CONDOTTO DX-SX</i>

Model Machine

MACSAE304

CRISTALLO 600 EVO 7GPM 1K (10004817)

Model Machine

MACSAE304

CRISTALLO 600 EVO 7GPM 1K (10004817)

MACSAE304.T.0008



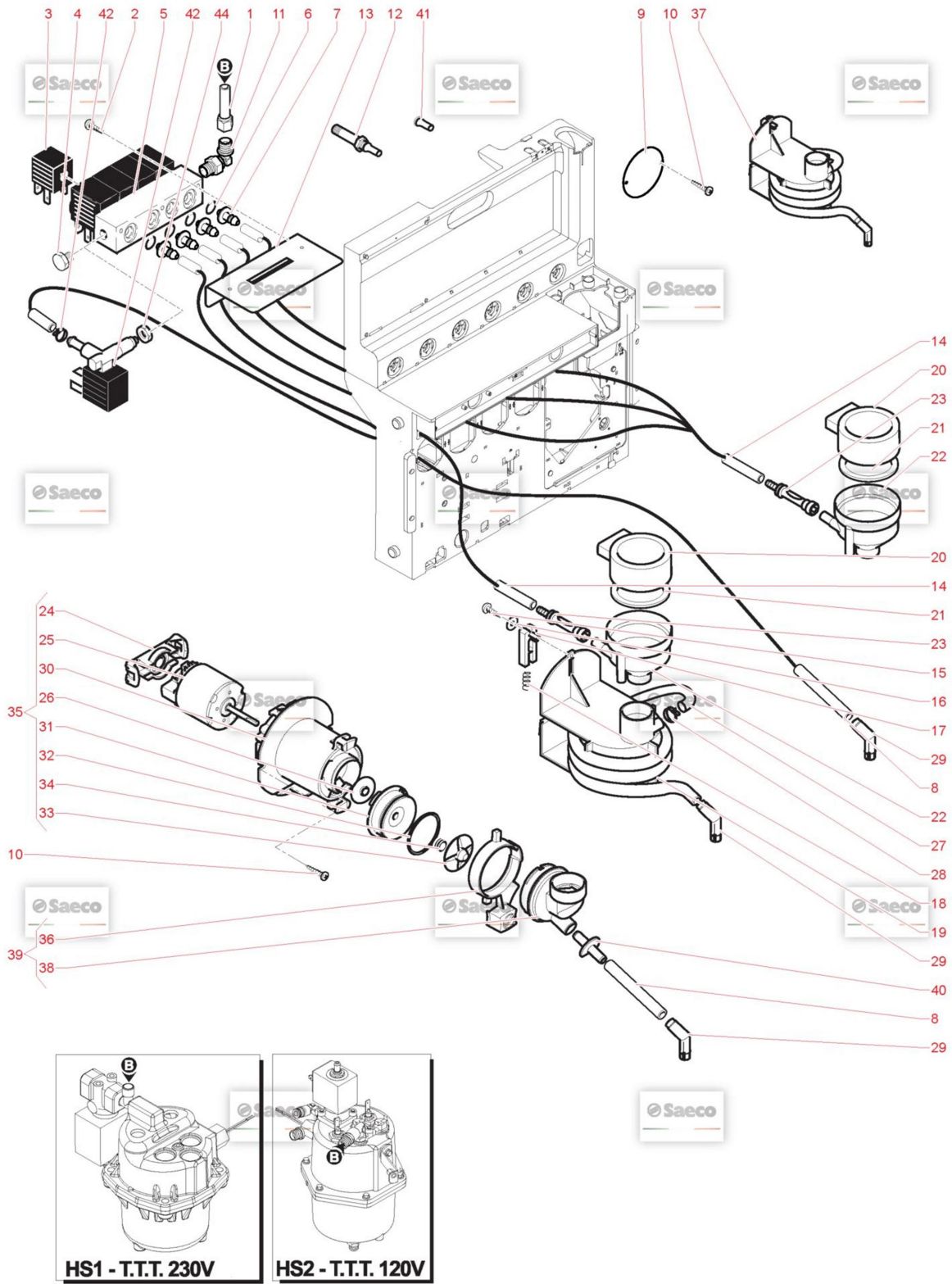









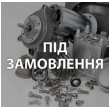













TAVOLA NR. 8 - ARTICOLO CRISTALLO 600 EVO 7GPM 1K (10004817)



Model Machine

MACSAE304











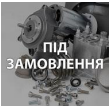















CRISTALLO 600 EVO 7GPM 1K (10004817)

Web	Pos.	Foto	Item - Replace by	Description
				<i>Press - CTRL + CLICK go to item in a new window Натисніть - Ctrl + права кнопка миші щоб відкрити запчастину в новому вікні</i>
	1		11025292	TEFLON TUBE 3X6 L.230 1/8"-1/8 TEFLON TUBE 3X6 L.230 1/8"-1/8
	1		11025295	TEFLON TUBE 3X6 L.170 1/8"-1/8 TEFLON TUBE 3X6 L.170 1/8"-1/8
	1		11025297	TEFLON TUBE 3X6 L.310 1/8"-1/8 TEFLON TUBE 3X6 L.310 1/8"-1/8
	1		9979.A27	TEFLON TUBE ASS. 4X6 L.310 1/8" TEFLON TUBE ASS. 4X6 L.310 1/8
	2		129516803	SCREW TCB3,5X19 DIN 7981 NICK SCREW TCB3,5X19 DIN 7981 NICK
	2		129824002	TCB SCREW M4X10 UNI 7687 ZNP VITE TCB M4X10 UNI 7687 ZNP
	2		U109.021	SCREW AUT.TCB 3,5X22 DIN 7981C SCREW AUT.TCB 3,5X22 DIN 7981 C
	3		20005373	SOLENOID X HS1 11023762 SOLENOID X OLAB 24V DC 6000BH/BODN
	4		12001169	ЛАТУННА ЗАГЛУШКА BRASS CAP 1/8 GAS CONICAL TEA BRASS CAP 1/8 GAS CONICAL TEA
	5		11011470	BLOCK 4 ELECTROVALVE DC OLAB TEA BLOCK 4 ELECTROVALVE DC OLAB TEA
	6		NM01.004	OR 2025 SILICONE OR 2025 SILICONE
	7		11011453	RUBBER HOLDER CONNECTOR TEA RUBBER HOLDER CONNECTOR TEA
	8		9972.057	КОРИЧНЕВА ГУМОВА ТРУБКА 5X8 2 МЕТРИ TUBO SILICONE MARRON 5X8 L.2000 MM

Model Machine

MACSAE304



























CRISTALLO 600 EVO 7GPM 1K (10004817)

	9		9111.405.060	MIXER HOLE CAP BROWN <i>MIXER HOLE CAP BROWN</i>
	10		U116.006	SCREW AUT.PT TCB 3,5X12 WN 1441 ZNP <i>VITE AUT.PT TCB 3,5X12 WN 1441 ZNP</i>
	11		11025082	1/8"G M/CONICAL ORIENT. NUT/OGV <i>1/8G M/CONICAL ORIENT. NUT/OGV</i>
	11		NR10.014	МЕТАЛЕВИЙ ПЕРЕХІДНИК 1/8" D.6 <i>RACCORDO 1/8" D.6 ORIENTABILE COD. OLAB</i>
	12		20005374	ASS.NUCLEO FIS+MOB.X 11009225 <i>ASS.NUCLEUS 6000BH/BODN X 11009225</i>
	13		9111.713	PLATE <i>PIASTRA ELETTROVALVOLE</i>
	14		9972.246	СИЛІКОНОВА ТРУБКА 5X10 SAECO 265918 (2 МЕТРИ) <i>TUBO SILICONE 5X10 L.2000 MM</i>
	15		U116.005	SCREW AUT.PT TCB 3,0X8 WN 1441 <i>VITE AUT.PT TCB 3,0X8 WN 1441 ZNP</i>
	16		U207.004	PLAIN WASHER 4,3X16 UNI 6592 GAL <i>PLAIN WASHER 4,3X16 UNI 6592 GAL</i>
	17		9111.209.060	CURSOR FOR SPIRAL MIXER FIXING <i>CURSOR FOR SPIRAL MIXER FIXING</i>
	18		9111.211	SPRING FOR MIXER CURSOR <i>MOLLA X CURSORE MISCELATORE</i>
	19		9111.643.060	RAPID FIXING MIXER <i>RAPID FIXING MIXER</i>
	20		9111.010.060	LID FOR FUNNEL BROWN <i>COPERCHIO X IMBUTO MARRON</i>
	21		9111.011.060	SEAL FOR FUNNEL BROWN <i>GUARNIZIONE X IMBUTO MARRON</i>

Model Machine

MACSAE304





















CRISTALLO 600 EVO 7GPM 1K (10004817)

	22		9111.009.060	FUNNEL FOR POWDERS BROWN <i>IMBUTO X POLVERI MARRON</i>
	23		1863.A07	ESPRESSO NOZZLE <i>ASS.UGELLO ESPRESSO</i>
	24		9111.771.270	MOTOR COUPLING ORANGE RAL <i>MOTOR COUPLING ORANGE RAL</i>
	25		9121.248.00P	MOTOP MIKCEPA '05 24V DC - M.B.T. COD. 912124800 SAECO 9121.248.00 <i>MOTORE MIXER '05 24V DC - M.B.T.</i>
	26		9111.773.060	MOTOR PROTECTION RING <i>ANELLO PROTEZIONE MOTORE MIXER '05</i>
	27		9972.055	ТРУБКА СИЛІКОНОВА 8X12 2 МЕТРИ <i>SILICONE TUBE 8X12 L.2000MM</i>
	28		NV99.072	HOSE CLAMP D. 11.6/12.3 <i>HOSE CLAMP D. 11.6/12.3</i>
	29		9111.349	ELBOW DISPENSING NOZZLE <i>UGELLO EROGAZIONE GOMITO</i>
	30		9111.769.150	MIXER FLANGE <i>MIXER FLANGE</i>
	31		9111.770.060	COVER MIXER FLANGE <i>COVER MIXER FLANGE</i>
	32		NM03.012	OR ORM 0320-25 NBR <i>OR ORM 0320-25 NBR</i>
	33		9111.772.060	DISK FAN <i>VENTOLINA A DISCO MIXER '05</i>
	34		NM05.015	ПРОКЛАДКА V-RING 405 МІКСЕРА ДЛЯ КАВОМАШИН SAECO <i>V-RING MIXER '05</i>

Model Machine

MACSAE304

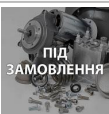
CRISTALLO 600 EVO 7ГРМ 1К (10004817)

	35		9110.160.06P	ДВИГУН МІКСЕРА ДЛЯ КАВОМАШИНИ SAECO 05 24V DC SAECO 9110.1... ASS.MIXER '05 24V DC GROUP 500 SAECO
	36		9111.230.270	MIXER LOCKING RING NUT ORANGERAL GHIERA BLOCCAGGIO MIXER ARANCIO RAL
	37		1863.A10	ASS.MIXER FS400 ASS.MIXER A SPIRALE FS400
	38		9111.227.060	MIXER CASING CORPO MIXER
	39		9110.027.060	MIX CASING ASS. ASS.CORPO MIX SAECO CRISTALLO,ATLANTE,QUARZO,RUBINO
	40		9111.232.060	STD TUBE HOLDER SLEEVE MANICOTTO PORTATUBO STANDARD
	40		9111.233.060	DECAFF.TUBE HOLDER SLEEVE MANICOTTO PORTATUBO DECAFFEINATO
	41		20007305	ЧАСТИНА ЕЛЕКТРОМАГНІТНОГО КЛАПАНА З ПОДВИЖНИМ СЕРДЕЧНИК... SPARE EV MOBILE CORE 11023762
	42		11027286	ELETTROVALVE 24V DC TEA ELETTROVALVE 24V DC TEA
	43	 ПІД ЗАМОВЛЕННЯ	NV99.036	HOSECLAMP D=8,5 09993.41.00 HOSECLAMP D=8,5 09993.41.00
	44		9991.035	NUT 1/8 H 4.5 DADO 1/8 H.4,5

Model Machine

MACSAE304

CRISTALLO 600 EVO 7GPM 1K (10004817)

MACSAE304.T.0009



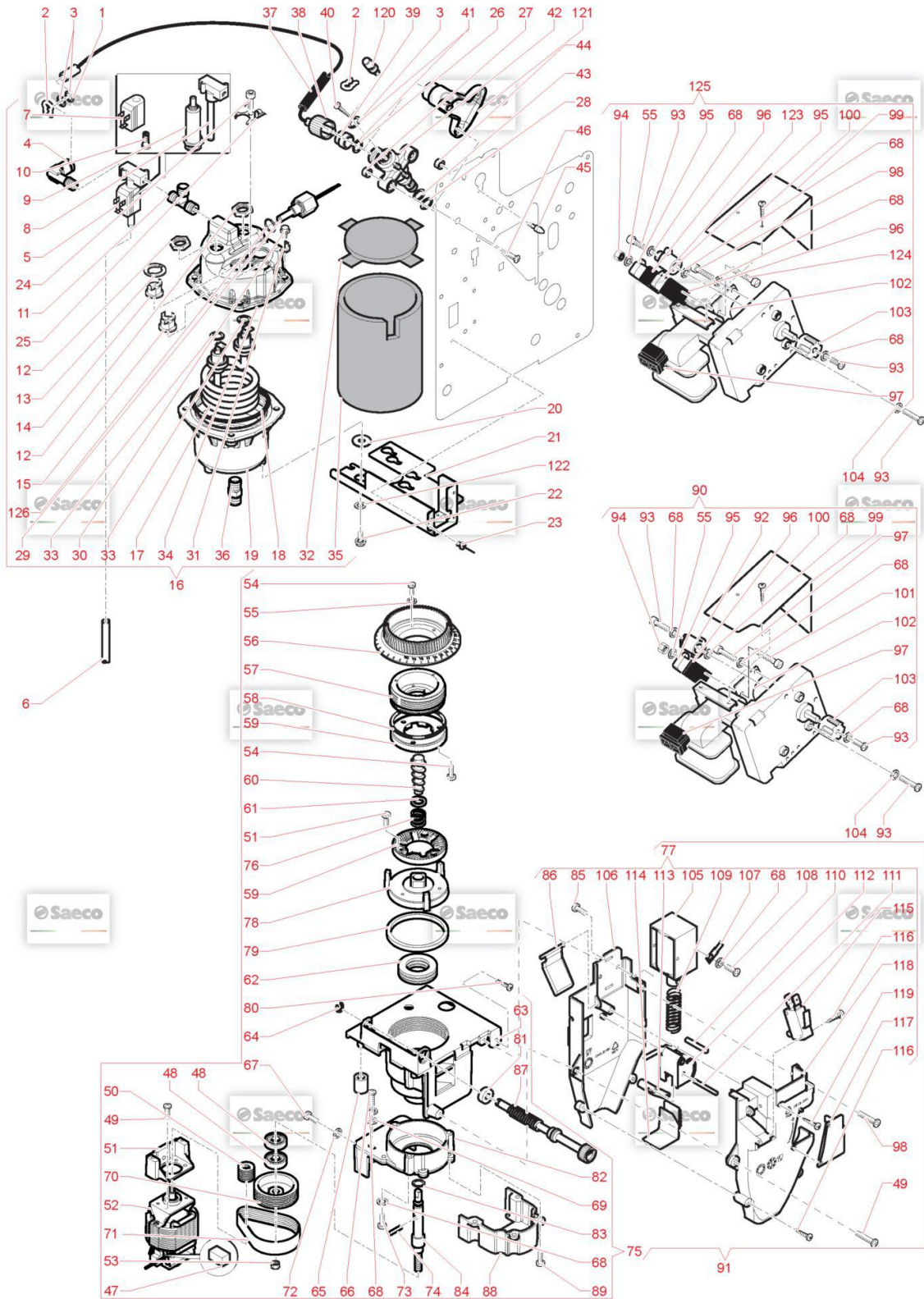









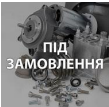













TAVOLA NR. 9 - ARTICOLO CRISTALLO 600 EVO 7GPM 1K (10004817)



Model Machine

MACSAE304





























CRISTALLO 600 EVO 7GPM 1K (10004817)

Web	Pos.	Foto	Item - Replace by	Description
				<i>Press - CTRL + CLICK go to item in a new window Натисніть - Ctrl + права кнопка миші щоб відкрити запчастину в новому вікні</i>
	1		11032592	TUBE TEFLON 4X2 L.320 <i>TUBE TEFLON 4X2 L.320</i>
	2		9011.144	SS FORK FOR TUBE D=4 <i>FORCELLA X TUBO D.4</i>
	3		140328059	OR 2015 SILICONE PTFE/FDA <i>OR 2015 SILICONE PTFE/FDA</i>
	4		9181.348	TEA/BRASS CONNECTOR 1/8" CONICAL AT 90° <i>TEA/BRASS CONNECTOR 1/8 CONICAL AT 90°</i>
	5		11032408	ЕЛЕКТРОМАГНІТНИЙ КЛАПАН 3 WAYS 24V <i>ELECTROVALVE ODE 3 WAYS 24V DC</i>
	6		9972.057	КОРИЧНЕВА ГУМОВА ТРУБКА 5X8 2 МЕТРИ <i>TUBO SILICONE MARRON 5X8 L.2000 MM</i>
	7		20007361	SOLENOID EVT ODE <i>SOLENOID EVT ODE</i>
	8		20007364	SPARE EVT 11032408 <i>SPARE EVT 11032408</i>
	9		20007363	SPARE EVT ODE <i>SPARE EVT ODE</i>
	10		20007362	SPARE CORE EV ODE <i>RIC. NUCLEO EVT ODE</i>
	11		11011454	"T" CONNECTOR FOR BOILER TEAT"" CONNECTOR FOR BOILER TEA <i>RACCORDO A T X CALDAIA TEA</i>
	12		9991.029	NUT FOR RESISTOR <i>DADO X RESISTENZA</i>
	13		9991.085	THERMOSTAT FIXING WASHER <i>RONDELLA FERMATERMOSTATI</i>

Model Machine

MACSAE304













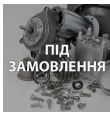

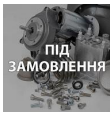







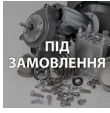

CRISTALLO 600 EVO 7GPM 1K (10004817)

	14		NE09.021	THERMOSTAT 150°NC FASTON 90° <i>TERMOSTATO 150°NC FASTON 90°</i>
	15		189428700	THERMOSTAT 175° 1NT-15L-5126 <i>THERMOSTAT 175° 1NT-15L-5126</i>
	16		11033527	BOILER 300CC EVO 1EV+SOLUBLES230 1,4KW <i>BOILER 300CC EVO 1EV+SOLUBLES 230 1,4KW</i>
	17		11007591	RES CALD. V230 W1400 INC.800 <i>RESISTENZA 230V 1400W INC.800</i>
	18		NM04.010	OR ORM 0730-40 FPM 70+-5 IRHDBLACK <i>OR ORM 0730-40 FPM 70 +-5 IRHD NERO</i>
	19		11033133	LOWER CASING BOILER 300CC TEA <i>CORPO INFERIORE CALDAIA 300CC TEA</i>
	20		9111.501	INSULATION WASHER <i>INSULATION WASHER</i>
	21		11033252	PLATE BOILER <i>SUPPORTO CALDAIA UNIFICATO</i>
	22		U005.011	SCREW TE M4,0X10 UNI 5739 GALV. <i>SCREW TE M4,0X10 UNI 5739 GALV.</i>
	22		U046.005	SCREW TE M5,0X10 WITH WASHER <i>SCREW TE M5,0X10 WITH WASHER</i>
	23		NF11.115	BLIND RIVETS <i>BLIND RIVETS</i>
	24		12001052	SCREW TCEI M4,0X6 DIN 912 ZIN <i>SCREW TCEI M4,0X6 DIN 912 ZIN</i>
	25		226830200	RETAIN.SPRING 3 THERM. +THERMAL FUSE <i>RETAIN.SPRING 3 THERM. +THERMAL FUSE</i>
	26		12001810	OR 275 DE.8,04 SILICONE PERNOMANICOTTO <i>OR 275 DE.8,04 SILICONE PERNO MANICOTTO</i>

Model Machine

MACSAE304

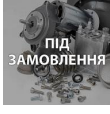

















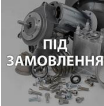

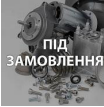



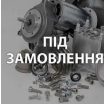

CRISTALLO 600 EVO 7ГРМ 1К (10004817)

	27		U302.003	МЕТАЛЕВА ГАЙКА M4 UNI 5588 ZNP <i>DADO ESAGONALE M4 UNI 5588 ZNP</i>
	28	 ПІД ЗАМОВЛЕННЯ	11013174	OR ORM 0050-20 FKM 80 FD GREENPEROXIDA <i>OR ORM 0050-20 FKM 80 FD GREEN PEROXIDA</i>
	28	 ПІД ЗАМОВЛЕННЯ	NM01.057	OR ORM 0050-20 IN SILICONE <i>OR ORM 0050-20 IN SILICONE</i>
	29		11033134	ПОГРУЖНИЙ ЗОНД ТЕМПЕРАТУРИ SAECO <i>ASS. SONDA TEMPERATURA AD IMMERSIONE</i>
	30		U023.020	SCREW TCEI M6X20 UNI 5931 ZIN <i>VITE TCEI M6X20 UNI 5931 8.8</i>
	31		NE15.031	MALE TONGUE PLAIN 6,3 D.6,3 <i>MALE TONGUE PLAIN 6,3 D.6,3</i>
	32		11030777	COFFEE BOILER 600CC UPPER ISOLATOR <i>COFFEE BOILER 600CC UPPER ISOLATOR</i>
	33	 ПІД ЗАМОВЛЕННЯ	11000972	OR 3050 FKM 80 FD PEROXIDICA <i>OR 3050 FKM 80 FD PEROXIDICA</i>
	34		11033131	UPPER CASING BOILER 300CC TEA <i>CORPO SURIORE CALDAIA 300CC TEA NUOVO PREZZO 32.64</i>
	35		11030779	ІЗОЛЯЦІЯ НИЖНЬОЇ ЧАСТИНИ БОЙЛЕРА 600CC <i>COFFEE BOILER 600CC UPPER ISOLATOR</i>
	36		9991.059	STRAIGHT BICONE CONNECTOR M 1/8X06 <i>STRAIGHT BICONE CONNECTOR M 1/8X06</i>
	37	 ПІД ЗАМОВЛЕННЯ	9972.236	BLACK SILICONE TUBE 7,5X9,3 L=200 MM <i>BLACK SILICONE TUBE 7,5X9,3 L=200 MM</i>
	38		11029574	ГАЙКА ДЛЯ РУЧНОГО ЗАЖИМУ M14 ДЛЯ ТРУБКИ 4X2 <i>GODRONE FEMMINA M14 X TUBO 4X2</i>

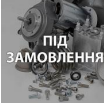
Model Machine

MACSAE304











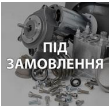

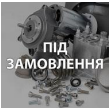













CRISTALLO 600 EVO 7GPM 1K (10004817)

	39		11005741	CONNECTOR D.6 BOCCOLA ESTERNA D.6
	40		U109.037	SCREW AUT.TCB 4,8X13 DIN 7981C VITE AUT.TCB 4,8X13 DIN 7981 C NIK
	41		140321462	O-RING 2018 SILICONE OR 2018 IN SILICONE
	42		11005370	PIN FOR MUFF PERNO X MANICOTTO PIN FOR MUFF
	42		11032673	PIN FOR MUFF PERNO X MANICOTTO CAPS
	43		11013173	OR ORM 0090-20 FKM 80 FD GREENPEROXIDA OR ORM 0090-20 FKM 80 FD GREEN PEROXIDA
	43		NM01.035	OR ORM 0090-20 SILICONE OR ORM 0090-20 SILICONE
	44		U302.001	NUT HEXAGONAL M5 UNI 5588 DADO ESAGONALE M5 UNI 5
	45		11006046	PEG FOR BOILER PEG FOR BOILER
	46		U044.013	SCREW TSPC M4,0X12 UNI 7688 GALV. VITE TSPC M4,0X12 UNI 7688 ZNP
	47		20007420	MOTOR BRUSH MOTOR BRUSH
	48		11025696	BEARING RTP 608-2Z BEARING RTP 608-2Z
	49		12002039	SCREW TCBD TORX 20 M4X12 ZN-B VITE TCBD TORX 20 M4X12 ZN-B
	50		11025690	PULLEY D.15 "GRIND 48" PULLEY D.15 "GRIND 48"

Model Machine

MACSAE304



























CRISTALLO 600 EVO 7GPM 1K (10004817)

	51		11027163	MOTOR SUPPORT GRINDERS D.48 <i>MOTOR SUPPORT GRINDERS D.48</i>
	52		11027396	COFFEEGRINDER MOTOR D.48 230V <i>COFFEEGRINDER MOTOR D.48 230V</i>
	52		11027810	COFFEEGRINDER MOTOR D.48 120V <i>MOTORE MACINACAFFE' D.48 120V</i>
	53		U310.004	NUT SELF LOCK.M6 UNI 7473 <i>NUT SELF LOCK.M6 UNI 7473</i>
	54		U043.007	SCREW TCBC M3,0X8 UNI 7687 GALV. <i>SCREW TCBC M3,0X8 UNI 7687 GALV.</i>
	55		U208.002	TOOTHED WASHER 3,3X5,8 UNI 3703 G <i>ROSETTA DENT. 3,3X5,8 UNI 3703 ZNP</i>
	56		11032640	КІЛЬЦЕ ПОМОЛУ ЗА ATL700 TTT Д.48 <i>ASS.GHIERA BLOCCATA X ATL700 TTT D.48</i>
	56		1813.103.A20	RING NUT OF GRIND REGULATION <i>RING NUT OF GRIND REGULATION</i>
	57		11025692	UPPER GRINDING DISK HOLDER "GRIND 48" <i>UPPER GRINDING DISK HOLDER "GRIND 48"</i>
	58		12001617	OR 3206 NBR <i>OR 3206 NBR</i>
	59		11021838	НІЖ КАВОМОЛКИ SAECO D-48 (1ШТ.) <i>FLAT MILL D.47 TEA</i>
	60		11025695	ШНЕК БОЛТИК ЗБІЛЬШЕННЯ "MACINE 48" <i>INCREASE SCREW "GRIND 48"</i>
	61		11027418	SPACER FOR SCREW OF INCREASE <i>SPACER FOR SCREW OF INCREASE</i>
	62		11025699	BEARING RTP 51104 <i>BEARING RTP 51104</i>

Model Machine

MACSAE304











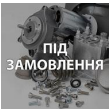



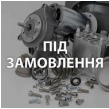

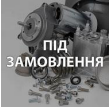







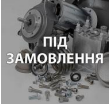

CRISTALLO 600 EVO 7GPM 1K (10004817)

	63		11027162	GRINDERS CAP D.48 <i>GRINDERS CAP D.48</i>
	64		U701.011	STEEL SNAP RING 5 UNI 7434 <i>ANELLO ELASTICO 5 UNI 7434</i>
	65		1813.046.050	RUBBER GRIND SUPPORT <i>RUBBER GRIND SUPPORT</i>
	66		12002052	ZN-B TCB SCREW M4X16 <i>ZN-B TCB SCREW M4X16</i>
	67		U023.004	SCREW TCEI M6,0X12 UNI 5931 GALV. <i>VITE TCEI M6,0X12 UNI 5931 Z</i>
	68		128310404	МЕТАЛЕВЕ УБЧАСТЕ КОЛІЩАТКО UNI 8842 A4 <i>WASHER UNI 8842 A4 BURNISHED</i>
	69		U207.004	PLAIN WASHER 4,3X16 UNI 6592 GAL <i>PLAIN WASHER 4,3X16 UNI 6592 GAL</i>
	70	 ПІД ЗАМОВЛЕННЯ	11025689	PULLEY D.40 "GRIND 48" <i>PULLEY D.40 "GRIND 48"</i>
	71		11032130	BELT GRINDER COFFEE <i>BELT GRINDER COFFEE</i>
	72		U208.006	TOOTHED WASHER 6,4X11 UNI 3703 <i>ROSETTA DENT. 6,4X11 UNI 3</i>
	73	 ПІД ЗАМОВЛЕННЯ	12001700	SCREW TCB M4X30 UNI 7687 ZNP <i>SCREW TCB M4X30 UNI 7687 ZNP</i>
	74	 ПІД ЗАМОВЛЕННЯ	11025921	POWER PLUG UNI-EN 28743 D.3X14 <i>POWER PLUG UNI-EN 28743 D.3X14</i>
	75	 ПІД ЗАМОВЛЕННЯ	11027165	КАВОМОЛКА В ЗБОРІ Д 48 SAECO 11027165 <i>COFFEE GRINDER D.48</i>

Model Machine

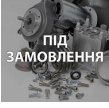
MACSAE304













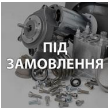



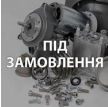









CRISTALLO 600 EVO 7GPM 1K (10004817)

	75		11029193	COFFEE GRINDER D.48 120V 60HZ ASS.MACINACAFFE' D.48 TTT 120V60HZ
	76		11025694	SPRING "GRIND 48" SPRING GRIND 48
	77		11033675	DOSER DOSER
	77		11033677	DOSER DOSER
	78		11025691	ТРИМАЧ НИЖНЬОГО НОЖА Д.48 LOWER GRINDING DISK HOLDER GRIND 48
	79		11027451	ПРОКЛАДКА DE=47,4 DI=41,4H=4 IN F ПРОКЛАДКА DE=47,4 DI=41,4H=4 IN F
	80		U116.006	SCREW AUT.PT TCB 3,5X12 WN 1441 ZNP VITE AUT.PT TCB 3,5X12 WN 1441 ZNP
	81		1813.159	ANTIVIBRATION RUBBER ANTIVIBRATION RUBBER
	82		11027164	MOTOR SUPPORT GRINDERS D.48 MOTOR SUPPORT GRINDERS D.48
	83		140321662	O-RING 2021 SILICONE OR 2021 IN SILICONE
	84		11025693	CENTRAL PIN "GRIND 48" CENTRAL PIN "GRIND 48"
	85		12002151	TSP SCREW M3X4 UNI 7688 SS TSP SCREW M3X4 UNI 7688 SS
	86		1813.042.A20	DISPENSER PALLET DISPENSER PALLET
	87		1813.104.A20	ADJUSTMENT SCREW WITH TUBE HOLDER VITE REGOLAZIONE MACININO

Model Machine

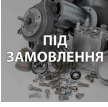
MACSAE304











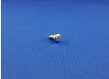











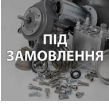

CRISTALLO 600 EVO 7ГРМ 1К (10004817)

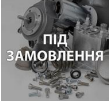
	88		11027186	ЧАСТИНА КРИПЛЕННЯ КАВОМОЛКИ SAECO <i>SHELL CLOSURE BELT</i>
	89		U127.010	SCREW TAPT.TCB M4,0X10 DIN 7500C <i>SCREW TAPT.TCB M4,0X10 DIN 7500C</i>
	90		11025216	ASS.RATIOMOTOR FOR DA 230V FS400 <i>ASS.RATIOMOTOR FOR DA 230V FS400</i>
	91		11033678	COFFEE GRINDER D.48 + DISPENCER <i>COFFEE GRINDER D.48 + DISPENCER</i>
	91		11034067	COFFEE GRINDER D.48 + DISPENCER CRS 120V <i>COFFEE GRINDER D.48 + DISPENCER CRS 120V</i>
	92		9991.037	CAM FOR RATIOMOTOR 1 MICRO <i>CAMMA X MOTORIDUTTORE 1 MICRO</i>
	93		129824002	TCB SCREW M4X10 UNI 7687 ZNP <i>VITE TCB M4X10 UNI 7687 ZNP</i>
	94		U302.002	NUT HEXAGONAL M3 UNI 5588 <i>NUT HEXAGONAL M3 UNI 5588</i>
	95		NE05.066	MICROSWITCH CHERRY D419Q1A <i>МІКРОПЕРЕМИКАЧ РЕДУКТОРА РОБОЧОЇ ГРУПИ</i>
	96		9991.014	CARD FOR MICRO SWITCHES <i>CARTONCINO X MICROINTERRUTTORE</i>
	97		11032817	RATIOMOTOR 30 PACK 230/240-50 <i>RATIOMOTOR 30 PACK 230/240-50</i>
	97		11032818	RATIOMOTOR 30 PACK 120/60 <i>RATIOMOTOR 30 PACK 120/60</i>
	98		129825502	TCB SCREW M4X25 UNI 7687 ZNP <i>TCB SCREW M4X25 UNI 7687 ZNP</i>
	99		11014251	CENTRAL UNIT MOTOR STEEL CARTER <i>CENTRAL UNIT MOTOR STEEL CARTER</i>

Model Machine

MACSAE304





















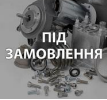



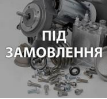

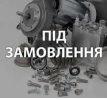
CRISTALLO 600 EVO 7GPM 1K (10004817)

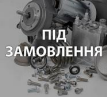
	10001		129511903	SCREW TCB 2,9X6,4 DIN 7981 BZNICK SCREW TCB 2,9X6,4 DIN 7981 BZ NICK
	1010		U034.003	SCREW TCI M3,0X20 UNI 6107 GALV. SCREW TCI M3,0X20 UNI 6107 GALV.
	1020		11003524	PLATE FOR MICRO RATIOMOTOR PLATE FOR MICRO RATIOMOTOR
	1020		9991.015	PLATE FOR MICRO PIASTRINA X MICRO
	1030		9991.013	JOINT FOR RATIOMOTOR GIUNTO X MOTORIDUTTORE
	1040		U207.002	PLAIN WASHER 4,3X9 UNI 6592 GAL ROSETTA PIANA 4,3X9 UNI 6592 ZNP
	1050		9121.235.00A	ELECTROMAGNET FOR DISPENSER WITH NUCLEUS ELETTR. PER DOSATORE CON NUCLEO
	1050		9121.235.00F	ELECTROMAGNET X DISPENSER W/NUCLEUS 120V ELECTROMAGNET X DISPENSER W/NUCLEUS 120V
	1060		11033683	DISPENSER SHELL DISPENSER SHELL
	1070		NE15.003	MALE TONGUE PLAIN 6,3 D.5,2 LINGUETTA MASCHIO PIANA 6,3 D.5,2
	1080		129821402	TCB SCREW M3X4 UNI 7687 ZNP TCB SCREW M3X4 UNI 7687 ZNP
	1090		1813.127	SPRING FOR ELECTROMAGNET MOLLA X ELETTRMAGNETE DOSAT
	1100		1813.092	PIN PIN

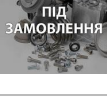
Model Machine

MACSAE304

CRISTALLO 600 EVO 7GPM 1K (10004817)

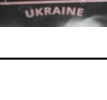
	1110		1813.091	PIN FOR DISPENSER REGULATION <i>PIN FOR DISPENSER REGULATION</i>
	1120		1813.043.A20	DISPENSER REGULATION <i>REGOLATORE DOSATORE</i>
	1130		1813.078.A20	ADJUSTMENT LEVER <i>ADJUSTMENT LEVER</i>
	1140		1813.044.A20	PALLET FOR REGULATION <i>PALETTA X REGOLATORE</i>
	1150		NE05.062	MICROSWITCH + WHEEL <i>MICROINTERRUTTORE C/ROTELLA</i>
	1160		U116.004	SCREW AUT.PT TCB 3,0X16 WN 1441 <i>SCREW AUT.PT TCB 3,0X16 WN 1441</i>
	1170		1813.191.A20	DISPENSER COVER <i>COPERTURA DOSATORE</i>
	1180		11033684	OUTSIDE SHELL DISPENSER <i>GUSCIO EST.DOSATORE 1813.041.A20 LAV.</i>
	1190		12000390	SCREW AUT.TCB 2,9X25 DIN 7981C NIK <i>SCREW AUT.TCB 2,9X25 DIN 7981 C NIK</i>
	1200		11033089	CAP SLEEVE CAPS <i>TAPPO MANICOTTO CAPS</i>
	1210		11013431	PHEDRA TTT SLEEVE TTT CIRCUIT <i>PHEDRA TTT SLEEVE TTT CIRCUIT</i>
	1220		U207.001	PLAIN WASHER 5,3X10 UNI 6592 GAL <i>ROSETTA PIANA 5,3X10 UNI 6</i>
	1230		11003525	CAM COFFEE GROUP FRESH BREW <i>CAM COFFEE GROUP FRESH BREW</i>
	1240		U034.001	SCREW TCI M3,0X30 UNI 6107 GALV. <i>VITE TCI M3,0X30 UNI 6107 ZNP</i>

Model Machine

MACSAE304

CRISTALLO 600 EVO 7GPM 1K (10004817)



1250

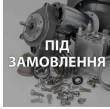

11023413

RATIOMOTOR CRISTALLO600 TTT 120V CSA
RATIOMOTOR CRISTALLO600 TTT 120V CSA



1250

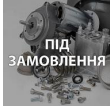

11023414

RATIOMOTOR CRISTALLO600 TTT 230V
RATIOMOTOR CRISTALLO600 TTT 230V



1260



11033220

OR ORM 2043 FKM 80 FD GREEN PEROXIDA
OR ORM 2043 FKM 80 FD GREEN PEROXIDA

Model Machine

MACSAE304

CRISTALLO 600 EVO 7GPM 1K (10004817)

MACSAE304.T.0010

TAVOLA NR. 10 - ARTICOLO CRISTALLO 600 EVO 7GPM 1K (10004817)

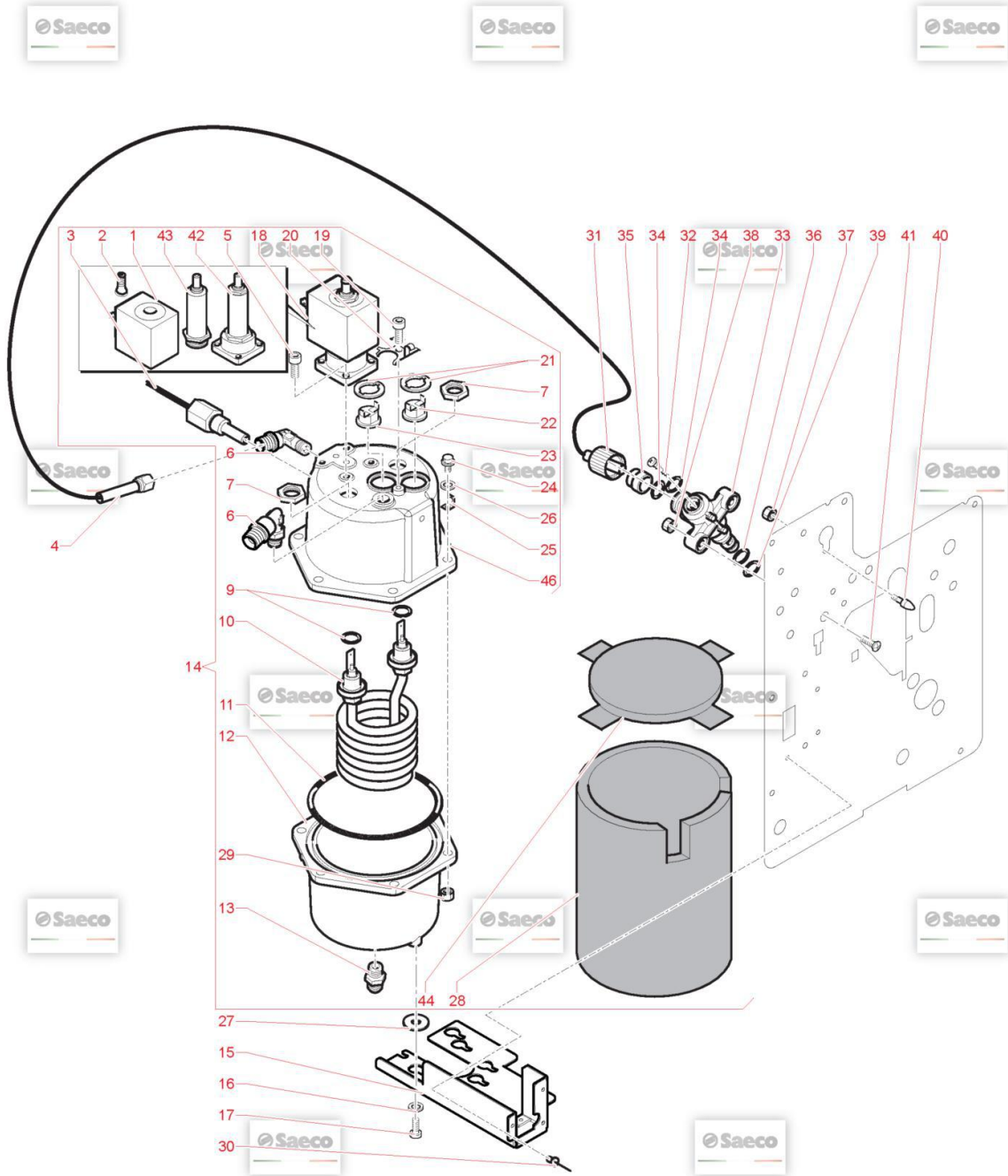

Model Machine

MACSAE304

CRISTALLO 600 EVO 7GPM 1K (10004817)

Web Pos. Foto Item - Replace by Description



*Press - CTRL + CLICK go to item in a new window
Натисніть - Ctrl + права кнопка миші щоб відкрити запчастину в новому вікні*



1



20007361

SOLENOID EVT ODE
SOLENOID EVT ODE



2



20007362

SPARE CORE EV ODE
RIC. NUCLEO EVT ODE



3



11005368

IMMERSION PROBE ASS.
ASS.SONDA TEMPER.AD.IMMERSIONE



4

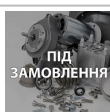

11025409

TUBE ASSEMBLY TEFLON 3X6 L.220MM
TUBE ASSEMBLY TEFLON 3X6 L.220MM



5

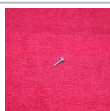

12001179

SCREW TCEI M4,0X12 UNI 5931 8.8 ZIN.
SCREW TCEI M4,0X12 UNI 5931 8.8 ZIN.



6

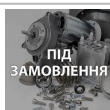

12001181

BICONICAL CONNECT. L M 1/8X06TEA
BICONICAL CONNECT. L M 1/8X06 TEA



7



9991.029

NUT FOR RESISTOR
DADO X RESISTENZA



8



11012528

UPPER CASING BOILER 600CC TEA
UPPER CASING BOILER 600CC TEA



9

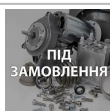

11000972

OR 3050 FKM 80 FD PEROXIDICA
OR 3050 FKM 80 FD PEROXIDICA



10



11005367

ЕЛЕКТРОВОДОНАГРІВАЧ 230V 1550W
HEAT ELEMENT BOILER 230V 1550W



11



12000770

OR ORM 4350 VITON
OR METRICO 4350 IN VITON



12



11012529

LOWER CASING BOILER 600CC TEA
LOWER CASING BOILER 600CC TEA



13













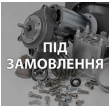

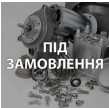













11027089

WATER INLET CONNECTOR
WATER INLET CONNECTOR

Model Machine

MACSAE304



























CRISTALLO 600 EVO 7GPM 1K (10004817)

	14		11025321	BOILER 600CC 230/50 TEA <i>BOILER ASS.CRISTALLO600 600CC 230/50 TEA</i>
	15		11033252	PLATE BOILER <i>SUPPORTO CALDAIA UNIFICATO</i>
	16		U207.001	PLAIN WASHER 5,3X10 UNI 6592 GAL <i>ROSETTA PIANA 5,3X10 UNI 6</i>
	17		U005.011	SCREW TE M4,0X10 UNI 5739 GALV. <i>SCREW TE M4,0X10 UNI 5739 GALV.</i>
	18		11012534	TEA ELECTROVALVE 2/3 WAY N.C. <i>TEA ELECTROVALVE 2/3 WAY N.C.</i>
	19		12001052	SCREW TCEI M4,0X6 DIN 912 ZIN <i>SCREW TCEI M4,0X6 DIN 912 ZIN</i>
	20		226760100	RETAINING SPRING 3 THERMOSTATS <i>RETAINING SPRING 3 THERMOSTATS</i>
	21		9991.085	THERMOSTAT FIXING WASHER <i>RONDELLA FERMATERMOSTATI</i>
	22		NE09.021	THERMOSTAT 150°NC FASTON 90° <i>TERMOSTATO 150°NC FASTON 90°</i>
	23		189428700	THERMOSTAT 175° 1NT-15L-5126 <i>THERMOSTAT 175° 1NT-15L-5126</i>
	24		U023.020	SCREW TCEI M6X20 UNI 5931 ZIN <i>VITE TCEI M6X20 UNI 5931 8.8</i>
	25		NE15.031	MALE TONGUE PLAIN 6,3 D.6,3 <i>MALE TONGUE PLAIN 6,3 D.6,3</i>
	26		U204.001	ELAS. WASHER 6,4X11,4 UNI 1751ZIN <i>ELAS. WASHER 6,4X11,4 UNI 1751 ZIN</i>
	27		9111.501	INSULATION WASHER <i>INSULATION WASHER</i>

Model Machine

MACSAE304

CRISTALLO 600 EVO 7GPM 1K (10004817)

	28		11030778	COFFEE BOILER 600CC UPPER ISOLATOR <i>ISOLANTE PERIMETR.CALDAIA 600CC VENDING</i>
	29		U302.004	NUT HEXAGONAL M6 UNI 5588 <i>DADO ESAGONALE M6 UNI 5</i>
	30		NF11.115	BLIND RIVETS <i>BLIND RIVETS</i>
	31		11005743	KNURLED FEMALE HAND BOLT M14 <i>GODRONE FEMMINA M14</i>
	32		U109.037	SCREW AUT.TCB 4,8X13 DIN 7981C <i>VITE AUT.TCB 4,8X13 DIN 7981 C NIK</i>
	33		11005370	PIN FOR MUFF <i>PERNO X MANICOTTO PIN FOR MUFF</i>
	34		140321462	O-RING 2018 SILICONE <i>OR 2018 IN SILICONE</i>
	35		11005741	CONNECTOR D.6 <i>BOCCOLA ESTERNA D.6</i>
	36		11013173	OR ORM 0090-20 FKM 80 FD GREENPEROXIDA <i>OR ORM 0090-20 FKM 80 FD GREEN PEROXIDA</i>
	37		U302.001	NUT HEXAGONAL M5 UNI 5588 <i>DADO ESAGONALE M5 UNI 5</i>
	38		U302.003	МЕТАЛЕВА ГАЙКА M4 UNI 5588 ZNP <i>DADO ESAGONALE M4 UNI 5588 ZNP</i>
	39		11013174	OR ORM 0050-20 FKM 80 FD GREENPEROXIDA <i>OR ORM 0050-20 FKM 80 FD GREEN PEROXIDA</i>
	40		11006046	PEG FOR BOILER <i>PEG FOR BOILER</i>

Model Machine

MACSAE304

CRISTALLO 600 EVO 7GPM 1K (10004817)

	41		U044.013	SCREW TSPC M4,0X12 UNI 7688 GALV. VITE TSPC M4,0X12 UNI 7688 ZNP
	42		20007370	SPARE EVT 11012534 SPARE EVT 11012534
	43		20007363	SPARE EVT ODE SPARE EVT ODE
	44		11030776	COFFEE BOILER 600CC UPPER ISOLATOR ISOLANTE SUP.CALDAIA 600CC VENDING

Model Machine

MACSAE304

CRISTALLO 600 EVO 7GPM 1K (10004817)

MACSAE304.T.0011

TAVOLA NR. 11 - ARTICOLO CRISTALLO 600 EVO 7GPM 1K (10004817)

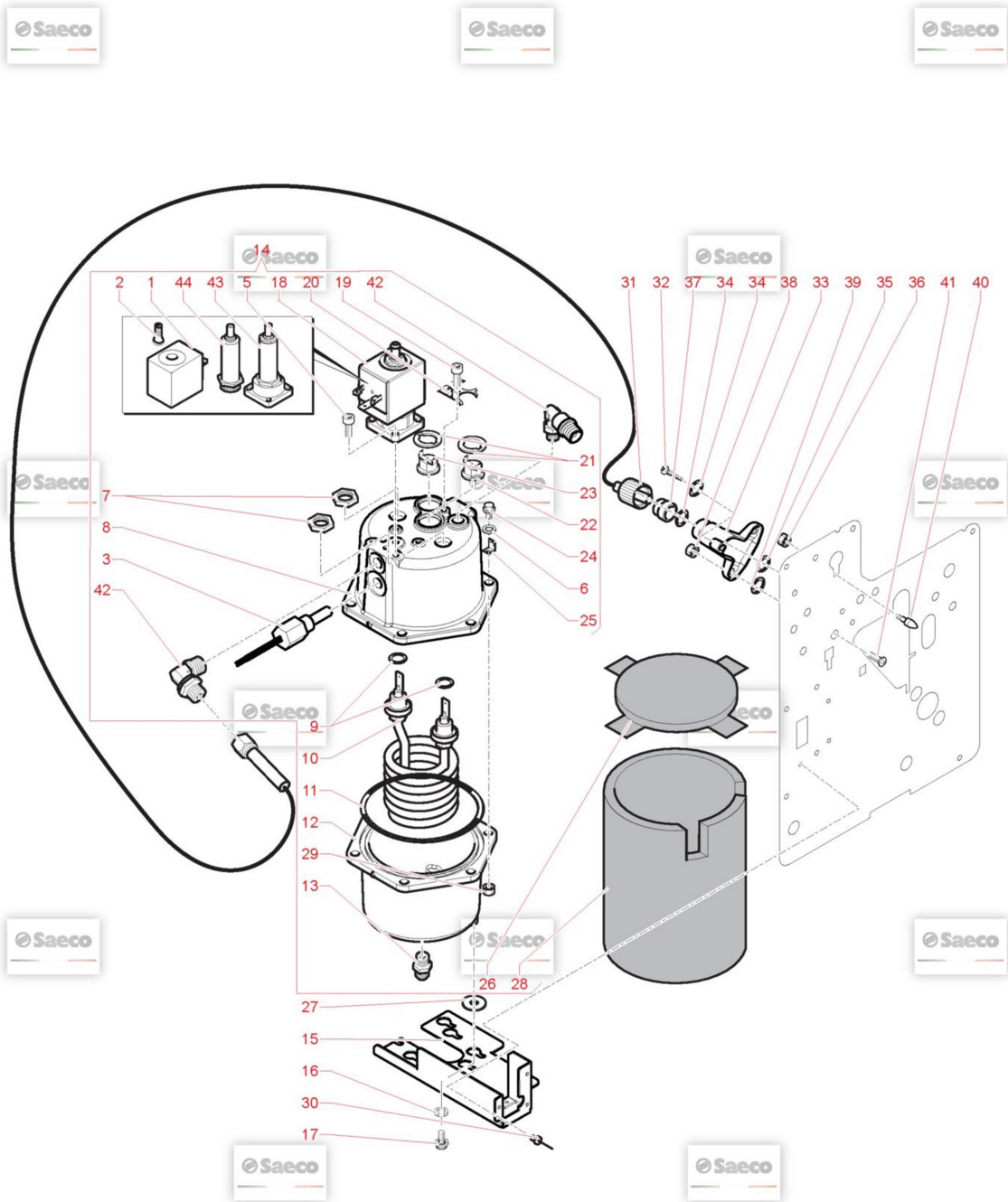

Model Machine

MACSAE304

CRISTALLO 600 EVO 7GPM 1K (10004817)

Web Pos. Foto Item - Replace by Description



*Press - CTRL + CLICK go to item in a new window
Натисніть - Ctrl + права кнопка миші щоб відкрити запчастину в новому вікні*



1



20007361

SOLENOID EVT ODE
SOLENOID EVT ODE



2



20007362

SPARE CORE EV ODE
RIC. NUCLEO EVT ODE



3



11005368

IMMERSION PROBE ASS.
ASS.SONDA TEMPER.AD.IMMERSIONE



4

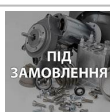

11025409

TUBE ASSEMBLY TEFLON 3X6 L.220MM
TUBE ASSEMBLY TEFLON 3X6 L.220MM



5

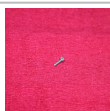

12001179

SCREW TCEI M4,0X12 UNI 5931 8.8 ZIN.
SCREW TCEI M4,0X12 UNI 5931 8.8 ZIN.



6

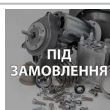

U204.001

ELAS. WASHER 6,4X11,4 UNI 1751ZIN
ELAS. WASHER 6,4X11,4 UNI 1751 ZIN



7



9991.029

NUT FOR RESISTOR
DADO X RESISTENZA



8



11012528

UPPER CASING BOILER 600CC TEA
UPPER CASING BOILER 600CC TEA



9

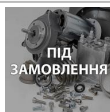

11000972

OR 3050 FKM 80 FD PEROXIDICA
OR 3050 FKM 80 FD PEROXIDICA



10

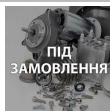

11005374

HEAT ELEMENT BOILER 120V 1100W
HEAT ELEMENT BOILER 120V 1100W



11



12000770

OR ORM 4350 VITON
OR METRICO 4350 IN VITON



12



11012529

LOWER CASING BOILER 600CC TEA
LOWER CASING BOILER 600CC TEA



13













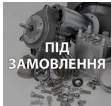

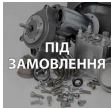



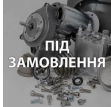





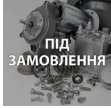



11027089

WATER INLET CONNECTOR
WATER INLET CONNECTOR

Model Machine

MACSAE304



























CRISTALLO 600 EVO 7GPM 1K (10004817)

	14		11034994	BOILER CRS600 EVO CC120/60 TEA <i>ASS.CALD.600CC DOO CRS600 EVO TEA 120V</i>
	15		11033252	PLATE BOILER <i>SUPPORTO CALDAIA UNIFICATO</i>
	16		U207.001	PLAIN WASHER 5,3X10 UNI 6592 GAL <i>ROSETTA PIANA 5,3X10 UNI 6</i>
	17		U046.007	SCREW TEFZ M4,0X12 GALV. <i>SCREW TEFZ M4,0X12 GALV.</i>
	18		11012534	TEA ELECTROVALVE 2/3 WAY N.C. <i>TEA ELECTROVALVE 2/3 WAY N.C.</i>
	19		12001052	SCREW TCEI M4,0X6 DIN 912 ZIN <i>SCREW TCEI M4,0X6 DIN 912 ZIN</i>
	20		226760100	RETAINING SPRING 3 THERMOSTATS <i>RETAINING SPRING 3 THERMOSTATS</i>
	21		9991.085	THERMOSTAT FIXING WASHER <i>RONDELLA FERMATERMOSTATI</i>
	22		NE09.021	THERMOSTAT 150°NC FASTON 90° <i>TERMOSTATO 150°NC FASTON 90°</i>
	23		189428700	THERMOSTAT 175° 1NT-15L-5126 <i>THERMOSTAT 175° 1NT-15L-5126</i>
	24		U023.020	SCREW TCEI M6X20 UNI 5931 ZIN <i>VITE TCEI M6X20 UNI 5931 8.8</i>
	25		NE15.031	MALE TONGUE PLAIN 6,3 D.6,3 <i>MALE TONGUE PLAIN 6,3 D.6,3</i>
	26		11030776	COFFEE BOILER 600CC UPPER ISOLATOR <i>ISOLANTE SUP.CALDAIA 600CC VENDING</i>
	27		9111.501	INSULATION WASHER <i>INSULATION WASHER</i>

Model Machine

MACSAE304

CRISTALLO 600 EVO 7GPM 1K (10004817)

	28		11030778	COFFEE BOILER 600CC UPPER ISOLATOR <i>ISOLANTE PERIMETR.CALDAIA 600CC VENDING</i>
	29		U302.004	NUT HEXAGONAL M6 UNI 5588 <i>DADO ESAGONALE M6 UNI 5</i>
	30		NF11.115	BLIND RIVETS <i>BLIND RIVETS</i>
	31		11005743	KNURLED FEMALE HAND BOLT M14 <i>GODRONE FEMMINA M14</i>
	32		U109.037	SCREW AUT.TCB 4,8X13 DIN 7981C <i>VITE AUT.TCB 4,8X13 DIN 7981 C NIK</i>
	33		11005370	PIN FOR MUFF <i>PERNO X MANICOTTO PIN FOR MUFF</i>
	34		140321462	O-RING 2018 SILICONE <i>OR 2018 IN SILICONE</i>
	35		11013173	OR ORM 0090-20 FKM 80 FD GREENPEROXIDA <i>OR ORM 0090-20 FKM 80 FD GREEN PEROXIDA</i>
	36		U302.001	NUT HEXAGONAL M5 UNI 5588 <i>DADO ESAGONALE M5 UNI 5</i>
	37		11005741	CONNECTOR D.6 <i>BOCCOLA ESTERNA D.6</i>
	38		U302.003	МЕТАЛЕВА ГАЙКА M4 UNI 5588 ZNP <i>DADO ESAGONALE M4 UNI 5588 ZNP</i>
	39		11013174	OR ORM 0050-20 FKM 80 FD GREENPEROXIDA <i>OR ORM 0050-20 FKM 80 FD GREEN PEROXIDA</i>
	40		11006046	PEG FOR BOILER <i>PEG FOR BOILER</i>

Model Machine

MACSAE304

CRISTALLO 600 EVO 7GPM 1K (10004817)



41



U044.013

SCREW TSPC M4,0X12 UNI 7688 GALV.
VITE TSPC M4,0X12 UNI 7688 ZNP



42

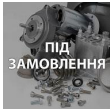

12001181

BICONICAL CONNECT. L M 1/8X06TEA
BICONICAL CONNECT. L M 1/8X06 TEA



43

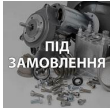

20007370

SPARE EVT 11012534
SPARE EVT 11012534



44

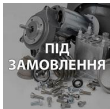

20007363

SPARE EVT ODE
SPARE EVT ODE

Model Machine

MACSAE304

CRISTALLO 600 EVO 7FPM 1K (10004817)

MACSAE304.T.0012

TAVOLA NR. 12 - ARTICOLO CRISTALLO 600 EVO 7FPM 1K (10004817)

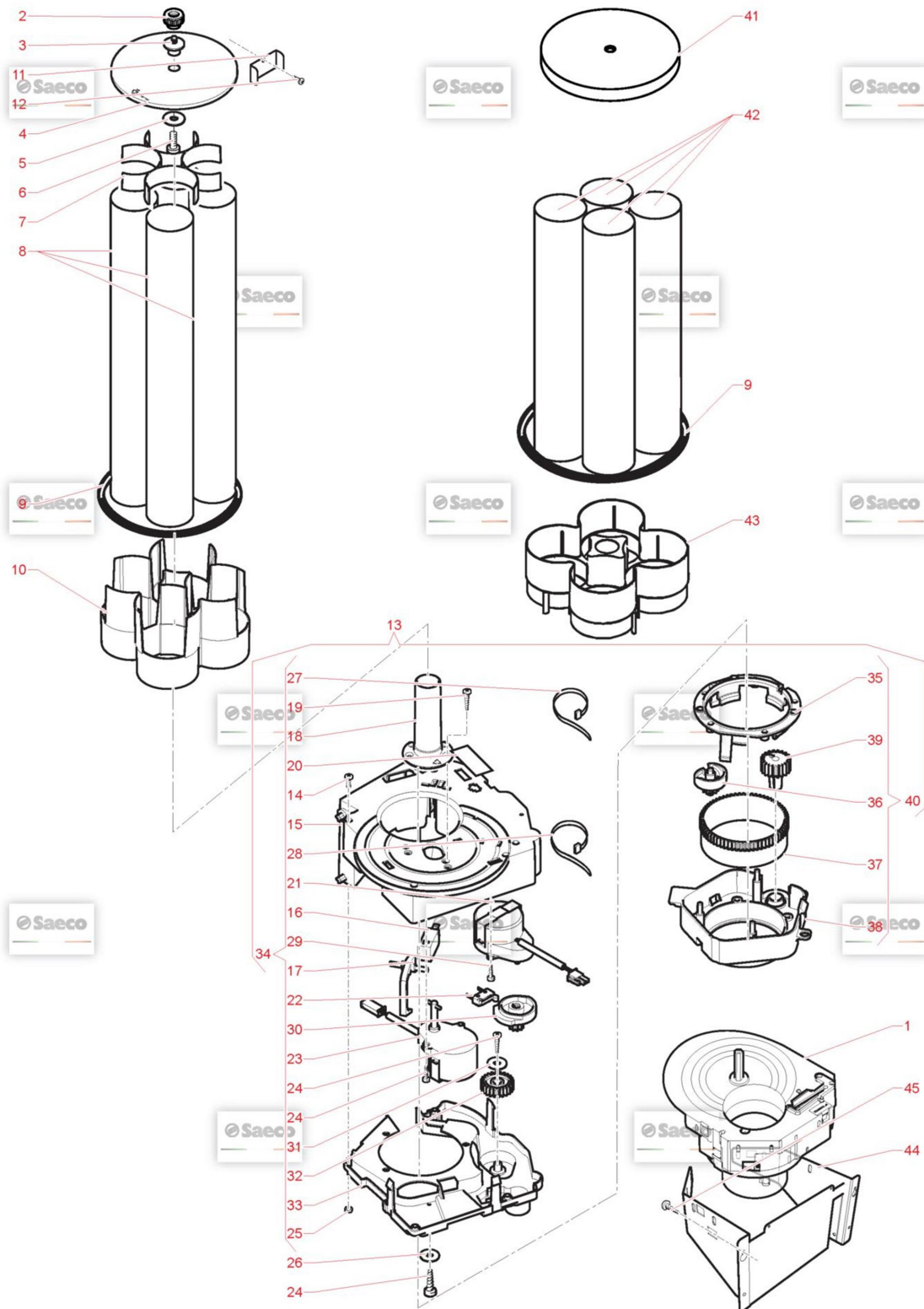

Model Machine

MACSAE304

CRISTALLO 600 EVO 7GPM 1K (10004817)

Web Pos. Foto Item - Replace by Description



Press - CTRL + CLICK go to item in a new window

Натисніть - Ctrl + права кнопка миші щоб відкрити запчастину в новому вікні



1

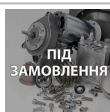

11027367

БЛОК ВИДАЧІ СТАКАНІВ D.80
DISPENSER GLASSES D.80



2



12002034

KNOB WITH BUSH M5
KNOB WITH BUSH M5



3



11010585

CENTRAL PIN FOR CUP COLUMN
CENTRAL PIN FOR CUP COLUMN



4



11028032

TANK LID GLASSES
TANK LID GLASSES



5

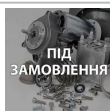

U207.009

PLAIN WASHER 5,5X15 UNI 6593 GA
PLAIN WASHER 5,5X15 UNI 6593 GA



6



U043.021

SCREW TCBC M5,0X8 UNI 7687 GALV.
VITE TCBC M5,0X8 UNI 7687 ZNP



7



11005072

CUP TUBE FIXING SPRING
CUP TUBE FIXING SPRING



8



11001422

TUBE PVC 80X1.5 L=705
TUBE PVC 80X1.5 L=705



9

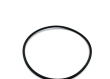

NM02.002

OR 4412 EPDM
OR 4412 EPDM



10



11000976

TANK DRINKS
SERBATOIO BICCHIERI UNIFICATO



11

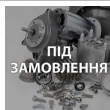

1813.162

BRACKET STOP DISPENCER
BRACKET STOP DISPENCER



12



U110.004

SCREW AUT.TCB 3,5X6,5 DIN 7981F
VITE AUT.TCB 3,5X6,5 DIN 7981 F NIK



13

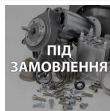











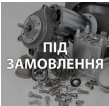















11004750

ASS. CUP DISPENSER 120V D.73
ASS. CUP DISPENSER 120V D.73

Model Machine

MACSAE304

















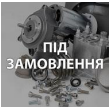

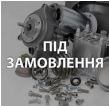





CRISTALLO 600 EVO 7GPM 1K (10004817)

	13		9110.140.A2A	CUP DISTRIBUTOR <i>ASS.DISTRIBUTORE BICCHIERI FS400</i>
	14		U034.001	SCREW TCI M3,0X30 UNI 6107 GALV. <i>VITE TCI M3,0X30 UNI 6107 ZNP</i>
	15		11000785	ВЕРХНІЙ КОРПУС БЛОКУ ВИДАЧІ СТАКАНІВ <i>CORPO SUPERIORE DISTRIBUTORE BICCHIERI</i>
	15		11000868	CASING UPPER CUP DISTRIBUTOR UL <i>CASING UPPER CUP DISTRIBUTOR UL</i>
	16		NE05.065	MICROSWITCH CHERRY D41R-QGAD_61 <i>MICROINTERRUTTORE CHERRY D419Q1A ATLANTE CRISTALLO NEXTAGE</i>
	17		1813.067.A20	LEVER <i>LEVA PRESENZA BICCHIERI</i>
	18		11000642	TUBE FOR BASKET GLASSES <i>CANOTTO PER CESTELLO BICCHIERI</i>
	19		U142.008	PANELVIT TSP 3,5X12 DIN 7505 AGAL <i>PANELVIT TSP 3,5X12 DIN 7505 A GAL</i>
	20		11001467	ADHESIVE LABEL PVC 54X30 MM <i>ADHESIVE LABEL PVC 54X30 MM</i>
	21		9121.226.00A	MOTOR SAIA UDS 5 RPM 220V <i>MOTORE SAIA UDS 5 RPM 220V</i>
	21		9121.226.00F	RATIOMOTOR SAIA UDS 5RPM 120V60HZ <i>RATIOMOTOR SAIA UDS 5RPM 120V 60HZ</i>
	22		NE05.064	MICROSWITCH SAIA V4NC <i>MICROINTERRUTTORE SAIA V4NC</i>
	23		11000391	MOTOR SAIA UDS1ND5M75CAN2WZ239 <i>MOTORE SAIA UDS1ND5M75CAN2WZ239</i>
	23		11000481	MOTOR SAIA CUP DISPENSER D6 PIVOT 120V <i>MOTOR SAIA CUP DISPENSER D6 PIVOT 120V</i>

Model Machine

MACSAE304











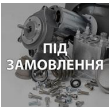





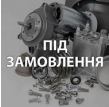







CRISTALLO 600 EVO 7GPM 1K (10004817)

	24		U116.005	SCREW AUT.PT TCB 3,0X8 WN 1441 VITE AUT.PT TCB 3,0X8 WN 1441 ZNP
	25		U324.005	NUT M3 FLANGED INDENTED BASE DADO M3 FLANGIATO BASE DENTELLATA
	26		U212.006	WASHER 3,2X11X0,5 ZNP WASHER 3,2X11X0,5 ZNP
	27	 ПІД ЗАМОВЛЕННЯ	NF11.002	SELF LOCK STRIP W=2.5 L=98 SELF LOCK STRIP W=2.5 L=98
	28	 ПІД ЗАМОВЛЕННЯ	144320200	SELF LOCK STRIP W=2.6 L=200 SELF LOCK STRIP W=2.6 L=200
	29		U109.005	SCREW AUT.TCB 3,5X16 DIN 7981C VITE AUT.TCB 3,5X16 DIN 798
	30		1863.066.A20	DISENGAGE CAM GLASSES DISENGAGE CAM GLASSES
	31		U201.001	PLAIN WASHER 3,2X9 DIN 7349 GALV. PLAIN WASHER 3,2X9 DIN 7349 GALV.
	32	 ПІД ЗАМОВЛЕННЯ	1813.068.A20	TOOTHED WHEEL TOOTHED WHEEL
	33	 ПІД ЗАМОВЛЕННЯ	1813.062.A20	LOWER CASING DISPENSER GLASSES LOWER CASING DISPENSER GLASSES
	33	 ПІД ЗАМОВЛЕННЯ	1813.308.050	LOVER CASING DISPENSER GLASSESUL LOVER CASING DISPENSER GLASSES UL
	34	 ПІД ЗАМОВЛЕННЯ	11003955	FS400 UL ASSEMBL.CUP DISP. GROUP FS400 UL ASSEMBL.CUP DISP. GROUP
	34	 ПІД ЗАМОВЛЕННЯ	9110.151.A2A	DISPENSER ASS. DISPENSER ASS.

Model Machine

MACSAE304

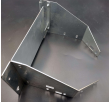
CRISTALLO 600 EVO 7GPM 1K (10004817)

	35	 ПІД ЗАМОВЛЕННЯ	11000786	RETAINING RING <i>RETAINING RING</i>
	36		1813.072.A20	SNAIL FOR GLASSES D.70 <i>CHIOCCIOLA X BICCHIERI</i>
	36		1813.192.050	SNAIL FOR GLASSES D.73 <i>CHIOCCIOLA X BICCHIERI D.73</i>
	37	 ПІД ЗАМОВЛЕННЯ	1813.073.A20	TOOTHED WHEEL FOR SNAIL <i>TOOTHED WHEEL FOR SNAIL</i>
	38	 ПІД ЗАМОВЛЕННЯ	11000833	SNAIL SUPPORT <i>SNAIL SUPPORT</i>
	39		1813.074.A20	TOOTHED WHEEL <i>TOOTHED WHEEL</i>
	40		11000835	ASS.SNAIL SUPPORT <i>ASS.SNAIL SUPPORT</i>
	40	 ПІД ЗАМОВЛЕННЯ	11000863	ASSEMBLY SUPPORT <i>ASSEMBLY SUPPORT</i>
	41		11027368	КРИШКА КАСЕТИ СТАКАНІВ D.80 <i>COPERCHIO CESTELLO BICCHIERI D.80</i>
	42		11028131	ТРУБКА PVC 84X1.5 L=620 <i>TUBO PVC 84X1.5 L=620</i>
	43	 ПІД ЗАМОВЛЕННЯ	11026360	BASE GLASSES BASKET 4 COLUMN D.80 <i>BASE CESTELLO BICCHIERI 4 COL. D.80</i>
	44		11034442	ТРИМАЧ ДИСПЕНСОРУ СТАКАНІВ D83 <i>SUPPORT CUP DISPENCER D83</i>
	45		U110.005	SCREW AUT.TCB 3,9X9,5 DIN 7981F <i>VITE AUT.TCB 3,9X9,5 DIN 798</i>

Model Machine

MACSAE304

CRISTALLO 600 EVO 7GPM 1K (10004817)

MACSAE304.T.0013

TAVOLA NR. 13 - ARTICOLO CRISTALLO 600 EVO 7GPM 1K (10004817)

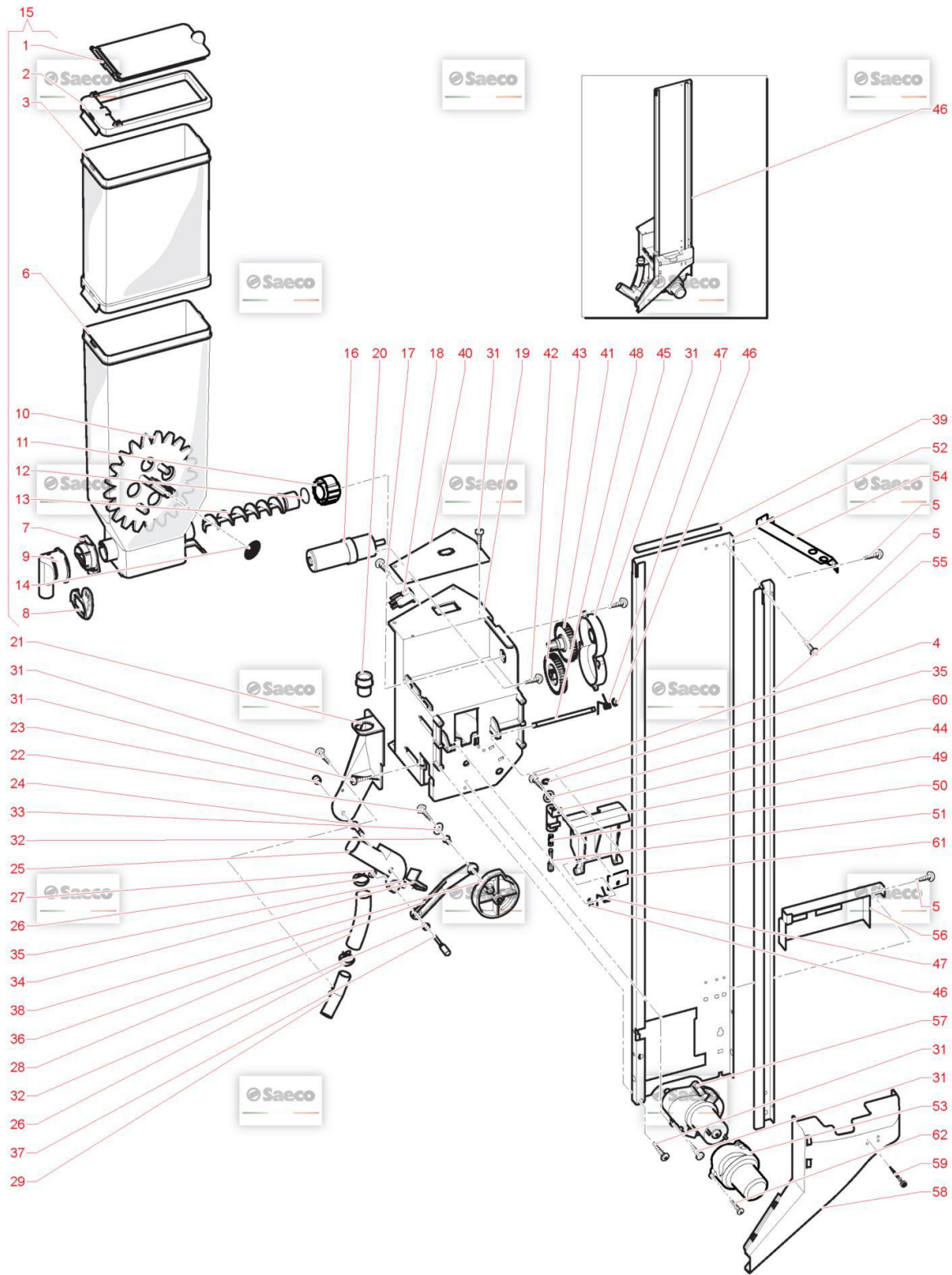

Model Machine

MACSAE304

CRISTALLO 600 EVO 7GPM 1K (10004817)

Web Pos. Foto Item - Replace by Description



Press - CTRL + CLICK go to item in a new window
Натисніть - Ctrl + права кнопка миші щоб відкрити запчастину в новому вікні



1



9111.683

SOLUBLE COVER
COPERCHIETTO SOLUBILI



2



9111.696

COVER SUGAR CONTAINER
COPERCHIO CONTENITORE ZUCCHERO



3



11004610

EXTENSION FOR CONTAINER SUGAR
PROLUNGAX CONTENITORE ZUCCHERO



4

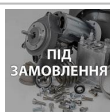

U117.003

SCREW AUT.PT TCB 2.5X10 WN 1442
SCREW AUT.PT TCB 2.5X10 WN 1442



5



U110.004

SCREW AUT.TCB 3,5X6,5 DIN 7981F
VITE AUT.TCB 3,5X6,5 DIN 7981 F NIK



6



9111.685

SUGAR CONTAINER
CONTENITORE ZUCCHERO



7



9111.630.060

BUSH FOR POWDERS TANK
BOCCOLA X SERBAT.POLVERI C/AGGANCI



8



9111.338.270

BULKHEAD FOR APERT. CLOSURE ORANGE
PARATIA CHIUSURA BOCCHETTA ARANCIO



9



9111.629.060

APERTURE FOR SOLUBLES HOPPER
APERTURE FOR SOLUBLES HOPPER



10



11032878

ШЕСТЕРНЯ КОНТЕЙНЕРА ДЛЯ ЦУКРУ (EX 9111.725)
CONTAINER WHEEL SUGAR BPA FREE



11



11012130

BACK BUSH REINFORCE
BACK BUSH REINFORCE



12



NM03.013

OR 2,3X15 NBR
OR 2,3X15 NBR



13













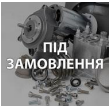

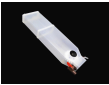













9111.726

SCROLL SCREW SUGAR CONTAINER
COCLEA CONTENITORE ZUCCHERO

Model Machine

MACSAE304















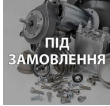

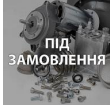





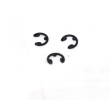

CRISTALLO 600 EVO 7GPM 1K (10004817)

	14		9111.646	ADHESIVE FOR TANK <i>ADHESIVE FOR TANK</i>
	15		11005129	ASSEMBLY SUGAR CONTAINER <i>ASS.CONT.ZUCCHERO CON PROLUNGA</i>
	16		9121.106.00P	SUGAR RATIONMOTOR 24V DC <i>MOTORIDUTTORE ZUCCHERO 24V D.C.</i>
	17		U110.007	SCREW AUT.TCB 2,9X16 DIN 7981F ZNP <i>SCREW AUT.TCB 2,9X16 DIN 7981 F ZNP</i>
	18		NE05.002	МІКРОВИМИКАЧ ДЛЯ КАВОМАШИНИ EF83161.8 <i>MICROINTERRUTTORE</i>
	19		11033196	СУПОРТ МЕХАНІЗМА МЕШАЛКИ САХАРА <i>SUPP.PALETTIERA</i>
	20		9111.699	ПЕРЕХОДНИК-ДЕРЖАТЕЛЬ ДЛЯ ТРУБКИ ВИДАЧИ САХАРА КОФЕМАШИ... <i>BOCCHETTA TUBO ZUCCHERO</i>
	21		9111.686.A20	SUPPORT SUGAR CONVEYER <i>SUPPORTO BASCULINA ZUCCHERO</i>
	22		U116.004	SCREW AUT.PT TCB 3,0X16 WN 1441 <i>SCREW AUT.PT TCB 3,0X16 WN 1441</i>
	23		11000388	KNOB M3 SUGAR CONVEYER <i>POMELLO M 3 BASCULINA ZUCCHERO</i>
	24		11000389	GRAINED PIVOT SUGAR COVEYER <i>PERNO ZIGRINATO BASCULINA ZUCCHERO</i>
	25		9111.690	SUGAR CONVEYER <i>BASCULINA ZUCCHERO</i>
	26		9111.553	SELF-ENERGIZING SPRING FOR TUBE D.2 <i>SELF-ENERGIZING SPRING FOR TUBE D.2</i>
	27		123160302	NUT M3 HIGH UNI 5587 GALVANIZED <i>NUT M3 HIGH UNI 5587 GALVANIZED</i>

Model Machine

MACSAE304











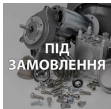















CRISTALLO 600 EVO 7GPM 1K (10004817)

	28		9111.700	SUGAR TUBE <i>TUBO ZUCCHERO</i>
	29		9111.697	CONNECTOR SUGAR TUBE <i>RACCORDO TUBO ZUCCHERO</i>
	30		11033206	DISTRIBUTOR 25RPM <i>DISTRIBUTOR 25RPM</i>
	30		11033212	SUGAR/SPOONS DISPENSER 120V 25RPM UL <i>ASS.DISTR.PALETTE/ZUCCH.120V 25RPM UL</i>
	31		U116.006	SCREW AUT.PT TCB 3,5X12 WN 1441 ZNP <i>VITE AUT.PT TCB 3,5X12 WN 1441 ZNP</i>
	32		9111.705	SPHERICAL PIN <i>PERNO SFERICO</i>
	33		U201.001	PLAIN WASHER 3,2X9 DIN 7349 GALV. <i>PLAIN WASHER 3,2X9 DIN 7349 GALV.</i>
	34		9111.727	BULKHEAD SUGAR CONVEYER <i>PARATIA BASCULINA ZUCCHERO</i>
	35		U701.011	STEEL SNAP RING 5 UNI 7434 <i>ANELLO ELASTICO 5 UNI 7434</i>
	36		9111.691	CONNECTING ROD SUGAR DISPENSER <i>BIELLA DISTRIBUTORE ZUCCHERO</i>
	37		11004295	KNOB FOR SUGAR CONNECTING RODPIPE <i>POMELLO BLOCCAGGIO BIELLA TUBO ZUCCH.</i>
	38		9111.688.A20	CAM SUGAR DISPENSER <i>CAMMA DISTRIBUTORE ZUCCHERO</i>
	39		9111.668	STIRRER DISP.COUNTERWEIGHT D.10 <i>CONTRAPPESO PALETTE D.10</i>

Model Machine

MACSAE304











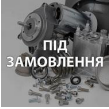

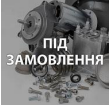



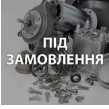

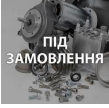

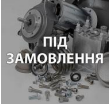



CRISTALLO 600 EVO 7GPM 1K (10004817)

	39		9111.669	STIRRER DISP.COUNTERWEIGHT D.10 <i>STIRRER DISP.COUNTERWEIGHT D.10</i>
	39		9111.745	STIRRER DISP.COUNTERWEIGHT <i>CONTRAPPESO PALETTE L=113MM</i>
	40		9111.707	REINFORCING PLATE <i>PIASTRA RINFORZO PALETTIERA</i>
	41		9111.694	JOINT WITH GEAR <i>GIUNTO CON INGRANAGGIO</i>
	42		U116.005	SCREW AUT.PT TCB 3,0X8 WN 1441 <i>VITE AUT.PT TCB 3,0X8 WN 1441 ZNP</i>
	43		9111.695	GEAR Z40 <i>INGRANAGGIO Z 40</i>
	44		9111.737	ОПОРА ТРУБКА ПЛАСТИКОВАЯ <i>SUPPORT</i>
	45		9111.687.A20	GEAR COVER <i>COPERCHIO INGRANAGGI</i>
	46		U701.006	ФІКСУЮЧА СКОБА 3,2 (ЗАПІЗО) SAECO <i>ANELLO ELASTICO 3,2</i>
	47		9111.730	SPRING <i>MOLLA ESPULSORE PALETTE</i>
	48		9111.376	PIN FOR STIRRER EXPELLER <i>PIN FOR STIRRER EXPELLER</i>
	49		11011240	STIRRER EXPELLER BLACK NEW <i>STIRRER EXPELLER BLACK NEW</i>
	50		11031341	SPRING <i>SPRING</i>
	51		11002209	PIN <i>PIN</i>

Model Machine

MACSAE304

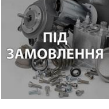
CRISTALLO 600 EVO 7GPM 1K (10004817)

	52		11009886	STIRRER GUIDE CRISTALLO400 NEW <i>STIRRER GUIDE CRISTALLO400 NEW</i>
	52		11009887	STIRRER GUIDE CRISTALLO600 NEW <i>STIRRER GUIDE CRISTALLO600 NEW</i>
	53		11025411	CRISTALLO SPOON'S MOTOR COVER <i>CRISTALLO SPOON'S MOTOR COVER</i>
	54		11032949	BRACKET FOR STIRRER GUIDE FS4N <i>BRACKET FOR STIRRER GUIDE FS4N</i>
	55		11001420	STIRRER GUIDE CRISTALLO600 <i>STIRRER GUIDE CRISTALLO600</i>
	55		9111.693	STIRRER GUIDE <i>STIRRER GUIDE</i>
	56		11007444	CARTER <i>CARTER</i>
	57		11033191	GEARMOTOR MECHTEX 25 RPM <i>MOTORIDUTTORE MECHTEX 25 RPM</i>
	58		9111.698.A20	STIRRER SLIDE <i>SCIVOLO PALETTE</i>
	59		9161.082	RUBBER COUPLER <i>AGGANCIO IN GOMMA</i>
	60		U207.003	PLAIN WASHER 3,2X7 UNI 6592 GALV. <i>PLAIN WASHER 3,2X7 UNI 6592 GALV.</i>
	61		11025089	PLATE REINFORCEMENT <i>PIASTRINA RINFORZO ESPULSORE</i>
	62		U110.003	SCREW AUT.TCB 3,5X9,5 DIN 7981F <i>VITE AUT.TCB 3,5X9,5 DIN 798</i>

Model Machine

MACSAE304

CRISTALLO 600 EVO 7GPM 1K (10004817)

MACSAE304.T.0014

TAVOLA NR. 14 - ARTICOLO CRISTALLO 600 EVO 7GPM 1K (10004817)

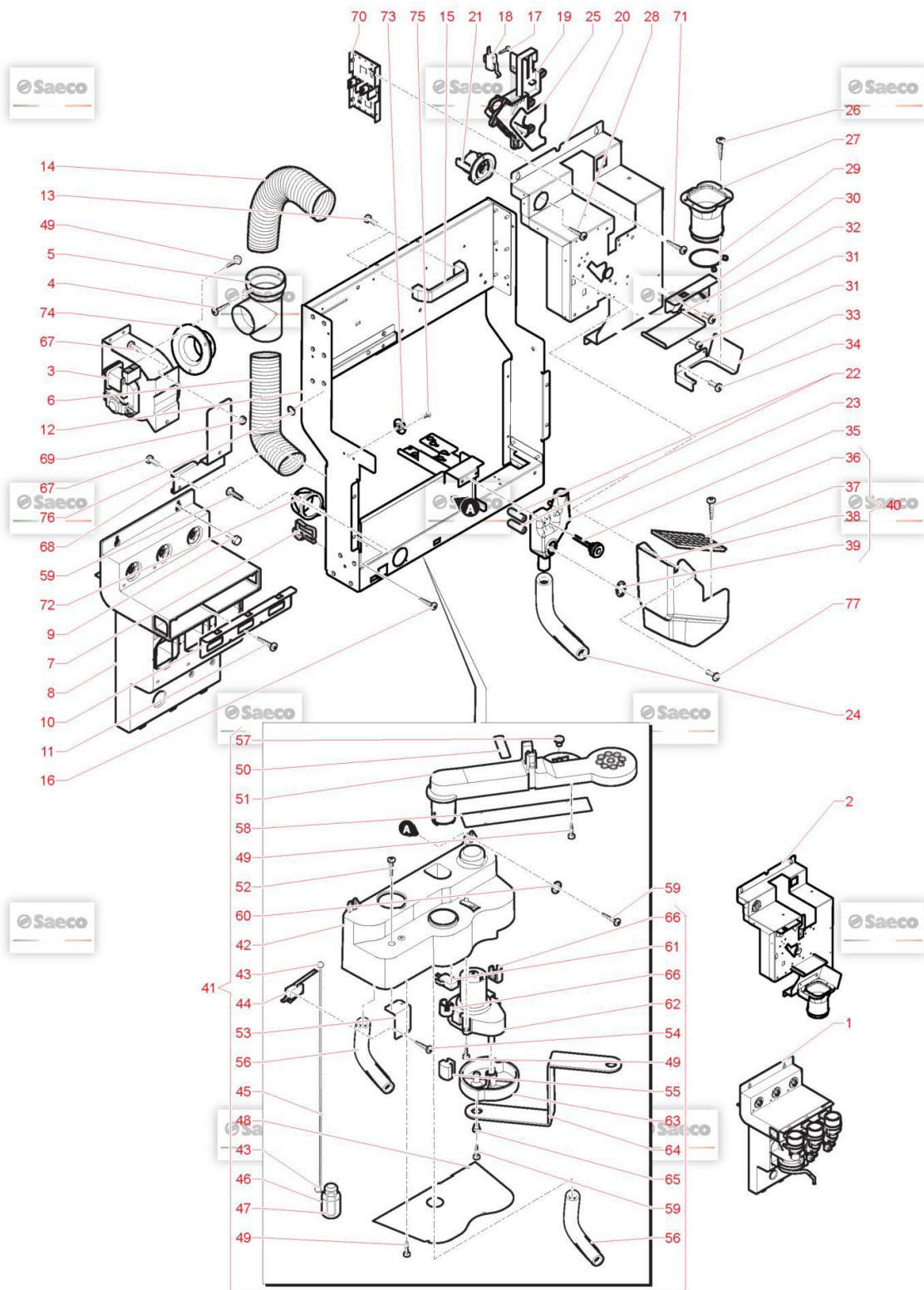

Model Machine

MACSAE304

CRISTALLO 600 EVO 7GPM 1K (10004817)

Web Pos. Foto Item - Replace by Description



Press - CTRL + CLICK go to item in a new window

Натисніть - Ctrl + права кнопка миші щоб відкрити запчастину в новому вікні



1

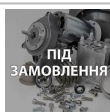

11008243

ASS. MODULE 3 MOTOR
ASS. MODULE 3 MOTOR



2

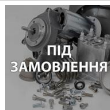

11033505

MOTOR MODULE CAPS
MOTOR MODULE CAPS



3



9121.198.00A

ВЕНТИЛЯТОР ВИТЯЖКИ 07 120X100X100 SAECO 9121.198.00A
VENTILATORE CENTRIFUGO CAP 07



4



U109.005

SCREW AUT.TCB 3,5X16 DIN 7981C
VITE AUT.TCB 3,5X16 DIN 798



5



9111.640.060

TUBE CONNECTOR
TUBE CONNECTOR



6



0862.145

SPIRAL TUBE L.210MM
SPIRAL TUBE L.210MM



7



9111.718

CLIP
CLIP



8



11008244

MODULE 3 MOTOR
MODULE 3 MOTOR



9

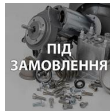

U046.001

SCREW TEFZ M5,0X16 UNI 6921 GALV.
SCREW TEFZ M5,0X16 UNI 6921 GALV.



10



11008245

ASPIRATION STEEL SHEET AT 3
ASPIRATION STEEL SHEET AT 3



11



U116.003

SCREW AUT.PT TCB 3,0X12 WN 1441
VITE AUT.PT TCB 3,0X12 WN 1441 ZNP



12

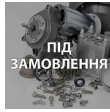

11033372

CRISTALLO400 CAPS PLATE
CRISTALLO400 CAPS PLATE



13

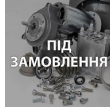











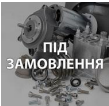

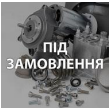













129827502

TCB SCREW M6X14 UNI 7687 ZNP
TCB SCREW M6X14 UNI 7687 ZNP

Model Machine

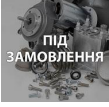
MACSAE304

























CRISTALLO 600 EVO 7GPM 1K (10004817)

	14		11010959	TUBE PVC OREGON D.32 L.170 <i>TUBE PVC OREGON D.32 L.170</i>
	15		12002150	HANDLE 37285 M.543/140 B-M6-C9 <i>HANDLE 37285 M.543/140 B-M6-C9</i>
	16		U023.009	SCREW TCEI M5,0X30 UNI 5931 8.8 B <i>SCREW TCEI M5,0X30 UNI 5931 8.8 B</i>
	17		U116.004	SCREW AUT.PT TCB 3,0X16 WN 1441 <i>SCREW AUT.PT TCB 3,0X16 WN 1441</i>
	18		NE05.050	MICROSWITCH <i>MICROSWITCH</i>
	19		11031002	CONVEYOR DUMP DISCHARGE <i>CONVEYOR DUMP DISCHARGE</i>
	20		11033506	COFFEE MODULE <i>COFFEE MODULE</i>
	21		11001574	FLANGE FIXING RATIONMOTOR LIP <i>FLANGIA FISSAGGIO MOTORIDUTTORI LIP</i>
	22		WGADM1908	SILICONE CUP <i>SILICONE CUP</i>
	23		11033769	SYPHON CRS400 EVO CAPS <i>SYPHON CRS400 EVO CAPS</i>
	24		9972.195	SILICONE TUBE 5X10 L.250MM <i>SILICONE TUBE 5X10 L.250MM</i>
	25		11031225	SPECIAL SEAL <i>SPECIAL SEAL</i>
	26		U111.008	NICK.SCREW AUT.TSP 3,5X9,5 DIN7982 C <i>NICK.SCREW AUT.TSP 3,5X9,5 DIN 7982 C</i>
	27		11031007	CONVEYOR DUMP <i>CONVEYOR DUMP</i>

Model Machine

MACSAE304

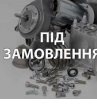









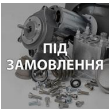







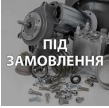

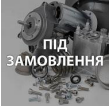





CRISTALLO 600 EVO 7GPM 1K (10004817)

	28		U116.006	SCREW AUT.PT TCB 3,5X12 WN 1441 ZNP VITE AUT.PT TCB 3,5X12 WN 1441 ZNP
	29		0862.112	GROUNDS SACK RING 8P КОЛЬЦО ANELLO SACCO FONDI 8P
	30	 ПІД ЗАМОВЛЕННЯ	11033509	CONTAINER COUPLER CONTAINER COUPLER
	31		U044.016	SCREW TSP M4,0X16 UNI 7688 GALV. VITE TSP M4, 0X16 UNI 7688 ZNP
	32	 ПІД ЗАМОВЛЕННЯ	11033496	SHEET METAL SUPPORT GROUP CAPS SHEET METAL SUPPORT GROUP CAPS
	33	 ПІД ЗАМОВЛЕННЯ	11033512	SUPPORT PLATE FOR EXHAUSTED CAPS SUPPORT PLATE FOR EXHAUSTED CAPS
	34	 ПІД ЗАМОВЛЕННЯ	U127.005	SCREW TAPT.TCB M4,0X8 DIN 7500C SCREW TAPT.TCB M4,0X8 DIN 7500C
	35	 ПІД ЗАМОВЛЕННЯ	12002032	KNOB D.18 M5X40 VOLANTINO ZIGRINATO D.18 M5X40
	36		U116.005	SCREW AUT.PT TCB 3,0X8 WN 1441 VITE AUT.PT TCB 3,0X8 WN 1441 ZNP
	37	 ПІД ЗАМОВЛЕННЯ	11032241	GRATE GRIGLIA X CONDOTTO CAPS
	38	 ПІД ЗАМОВЛЕННЯ	11032632	COFFEE CONVEY CRS EVO CONVOGLIATORE FONDI CAPS CRS EVO
	39	 ПІД ЗАМОВЛЕННЯ	11033768	SEAL SEAL
	40	 ПІД ЗАМОВЛЕННЯ	11033861	CONVEYOR EXPIRE CAPSULS CRS EVO CONVEYOR EXPIRE CAPSULS CRS EVO

Model Machine

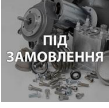
MACSAE304

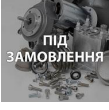



























CRISTALLO 600 EVO 7GPM 1K (10004817)

	41		11033202	NOZZLE ARM NOZZLE ARM
	42		11033186	SUPPORT NOZZLE ARM SUPPORT NOZZLE ARM
	43		9111.148	ELASTIC RING FOR FLOAT ANELLO ELASTICO X GALLEGGIANTE
	44		NE05.041	MICROSWITCH MICROINTERRUTTORE
	45		9111.775	CHAIN CHAIN
	46		9111.130	FLOAT FOR DISCHARGE LEVEL FLOAT FOR DISCHARGE LEVEL
	47		9111.147	COUNTERWEIGHT FOR FLOAT CONTRAPPESO X GALLEGGIANTE
	48		9111.722	PLATE PIASTRA SUPPORTO BRACCIO
	49		129670202	TCB PANELVIT SCREW 3,5X16 TESTA D=8 ZNP TCB PANELVIT SCREW 3,5X16 TESTA D=8 ZNP
	50		140321560	O-RING 3187 NBR OR 3187 IN NBR
	51		9111.710.A20	NOZZLE ARM BRACCIO GIREVOLE
	52		129512903	SCREW TCB PH-AB 2,9X13 UNI 6954 NI SCREW TCB PH-AB 2,9X13 UNI 6954 NI
	53		9111.719	PLATE PLATE
	54		U109.003	SCREW TCB 3,5X9,5 DIN 7981 C NICK SCREW TCB 3,5X9,5 DIN 7981 C NICK

Model Machine

MACSAE304













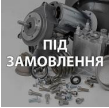



CRISTALLO 600 EVO 7GPM 1K (10004817)

	55		0875.150	RUBBER FOR DISPENSING COMP. <i>RUBBER FOR DISPENSING COMP.</i>
	56		11001454	PVC TUBE 16X22 L.350 MM <i>TUBO PVC 16X22 L.180MM</i>
	57		NV01.009	RUBBER BUFFER <i>GOMMINO PARACOLPI</i>
	58		9111.723	PLATE <i>PIASTRA X BRACCIO</i>
	59		U116.002	SCREW AUT.PT TCB 3,5X16 WN 1441 <i>SCREW AUT.PT TCB 3,5X16 WN 1441</i>
	60		U207.002	PLAIN WASHER 4,3X9 UNI 6592 GAL <i>ROSETTA PIANA 4,3X9 UNI 6592 ZNP</i>
	61		NE05.010	MICROSWITCH <i>MICROINTERRUPTORE</i>
	62		11033191	GEARMOTOR MECHTEX 25 RPM <i>MOTORIDUTTORE MECHTEX 25 RPM</i>
	63		9111.716.A20	CAM ARM <i>CAMMA BRACCIO</i>
	64		9111.715	CONNECTING ROD ARM <i>BIELLA BRACCIO</i>
	65		9111.204	BUSH FOR SPRING COMPENSATE STIRRER <i>BOCCOLA X MOLLA BILANCERE PALETTE</i>
	66		11033193	SPACER MOTOR ARM <i>SPACER MOTOR ARM</i>
	67		U043.015	SCREW TCBC M5,0X12 UNI 7687 GALV. <i>SCREW TCBC M5,0X12 UNI 7687 GALV.</i>
	68		11033514	SUPPORT PLATE FOR FAN CRISTALLO CAPS <i>SUPPORT PLATE FOR FAN CRISTALLO CAPS</i>

Model Machine

MACSAE304

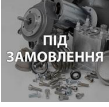
CRISTALLO 600 EVO 7GPM 1K (10004817)

	69		U324.003	NUT M5 FLANGED INDENTED BASE <i>NUT M5 FLANGED INDENTED BASE</i>
	70		11033067	PANEL FOR ORIENTATION FILTERS <i>PANEL FOR ORIENTATION FILTERS</i>
	71		12002052	ZN-B TCB SCREW M4X16 <i>ZN-B TCB SCREW M4X16</i>
	72		0701.029.060	APERTURE FOR ASPIRATION <i>APERTURE FOR ASPIRATION</i>
	73		11033520	BUSH X PLATE <i>BUSH X PLATE</i>
	74		11033811	BUSH FOR FAN <i>BUSH FOR FAN</i>
	75		U044.013	SCREW TSPC M4,0X12 UNI 7688 GALV. <i>VITE TSPC M4,0X12 UNI 7688 ZNP</i>
	76		12002140	CAP RBF-4.8-11.1-16 <i>CAP RBF-4.8-11.1-16</i>
	77		U110.003	SCREW AUT.TCB 3,5X9,5 DIN 7981F <i>VITE AUT.TCB 3,5X9,5 DIN 798</i>

Model Machine

MACSAE304

CRISTALLO 600 EVO 7GPM 1K (10004817)

MACSAE304.T.0015

TAVOLA NR. 15 - ARTICOLO CRISTALLO 600 EVO 7GPM 1K (10004817)

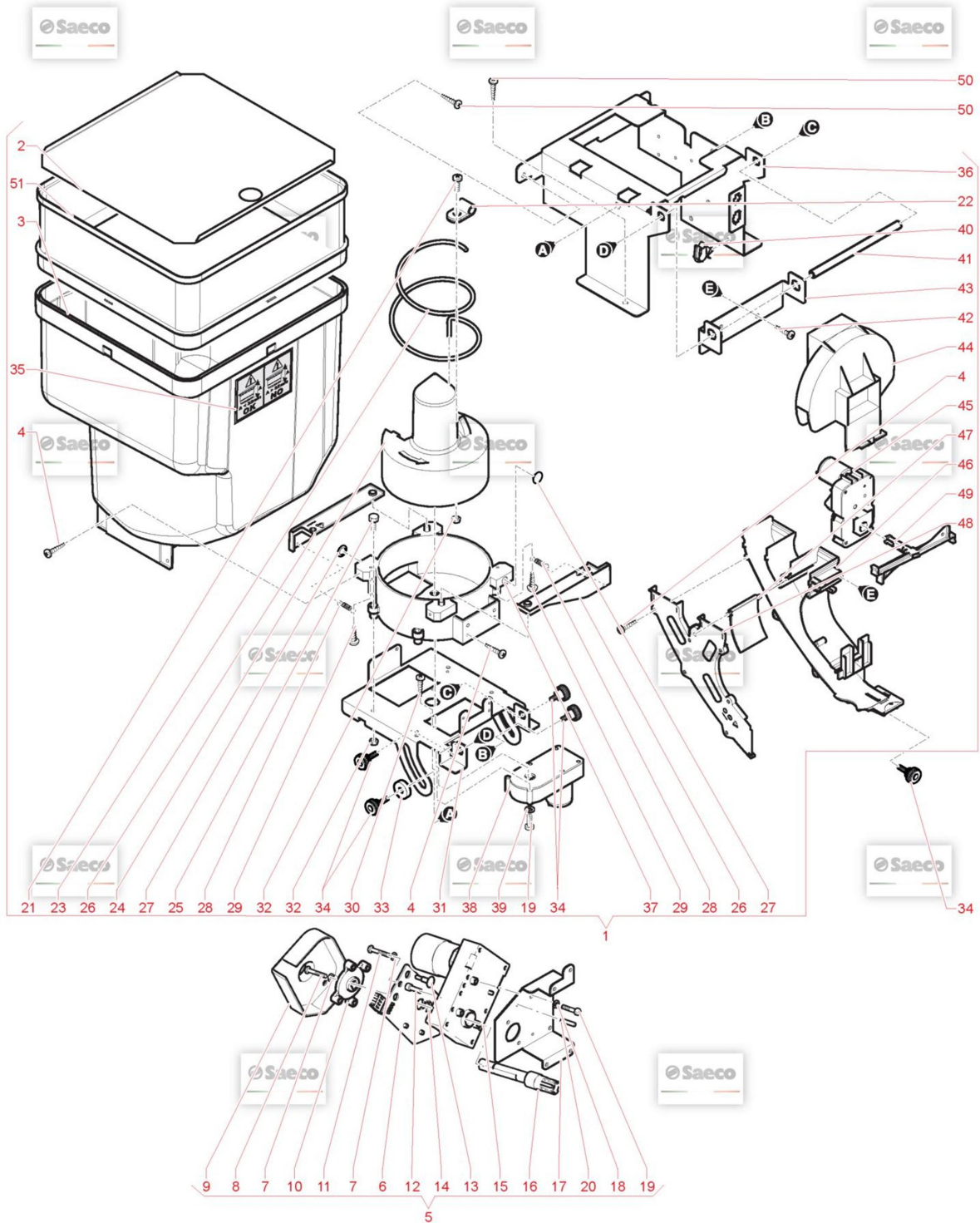

Model Machine

MACSAE304

CRISTALLO 600 EVO 7GPM 1K (10004817)

Web Pos. Foto Item - Replace by Description



Press - CTRL + CLICK go to item in a new window











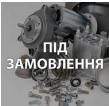

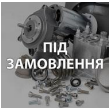













Натисніть - Ctrl + права кнопка миші щоб відкрити запчастину в новому вікні

	1		11032772	LOADER COMPLETE CAPS CL ASS.CARICATORE COMPLETO CAPS CL
	1		11033479	LOADER COMPLETE CAPS CC LOADER COMPLETE CAPS CC
	1		11034355	LOADER COMPLETE CAPS CO LOADER COMPLETE CAPS CO
	2		11032685	COVER CONTAINER COPERCHIO CONTENITORE EVO CAPS
	3		11032682	CONTAINER CONTAINER
	4		U116.006	SCREW AUT.PT TCB 3,5X12 WN 1441 ZNP VITE AUT.PT TCB 3,5X12 WN 1441 ZNP
	5		11033231	RATIOMOTOR GROUP CAPS ASS. MOTORIDUTTORE GRUPPO CAPS EVO
	6		11002134	CARD 2 SENSOR RATIOMOTOR CARD 2 SENSOR RATIOMOTOR
	7		U207.002	PLAIN WASHER 4,3X9 UNI 6592 GAL ROSETTA PIANA 4,3X9 UNI 6592 ZNP
	8		U005.010	SCREW TE M4,0X14 UNI 5739 GALV. SCREW TE M4,0X14 UNI 5739 GALV.
	9		11002211	CARD PROTECTION RATIOMOTOR CARD PROTECTION RATIOMOTOR
	10		11031224	CAM CAM
	11		U005.012	SCREW TE M4,0X30 UNI 5739 GALV. SCREW TE M4,0X30 UNI 5739 GALV.

Model Machine

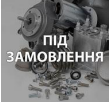
MACSAE304

















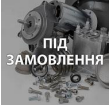





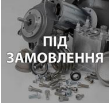

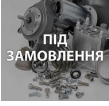
CRISTALLO 600 EVO 7GPM 1K (10004817)

	12		11002964	SPACE FOR CENTRAL CARD 2 SENSORY <i>SPACE FOR CENTRAL CARD 2 SENSORY</i>
	13		NL04.014	SPACER CARD H=9,5 <i>SPACER CARD H=9,5</i>
	14		120340804	EL. SHAFT RETAIN.RING D=8 UNI7435 <i>EL. SHAFT RETAIN.RING D=8 UNI 7435</i>
	15		12000232	LIP RATIO MOTOR ST.112B 24VDC 11RPM <i>LIP RATIO MOTOR ST.112B 24VDC 11RPM</i>
	16		11002133	JOINT WITH SHAFT FOR RATIO MOTOR <i>JOINT WITH SHAFT FOR RATIO MOTOR</i>
	17		11033219	SUPPORT PLATE MOTOR <i>SUPPORT PLATE MOTOR</i>
	18		128310404	МЕТАЛЕВЕ УБЧАСТЕ КОЛІЩАТКО UNI 8842 A4 <i>WASHER UNI 8842 A4 BURNISHED</i>
	19		129824002	TCB SCREW M4X10 UNI 7687 ZNP <i>VITE TCB M4X10 UNI 7687 ZNP</i>
	20		U407.001	ELASTIC PIN 3,0X20 UNI 6874 <i>ELASTIC PIN 3,0X20 UNI 6874</i>
	21		129825002	TCB SCREW M4X20 UNI 7687 ZNP <i>TCB SCREW M4X20 UNI 7687 ZNP</i>
	22		12001926	CABLE CLAMP SCREW FASTENING 6571 AA00 <i>CABLE CLAMP SCREW FASTENING 6571 AA00</i>
	23		11031030	SPECIAL SPRING <i>MOLLA AGITATORE CAPS</i>
	24		11032145	ROTORE CAPS <i>ROTORE CAPS</i>
	24		11032373	ROTORE CAPS CA <i>ROTORE CAPS CA</i>

Model Machine

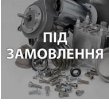
MACSAE304











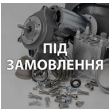

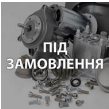



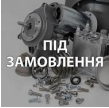

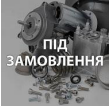

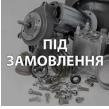

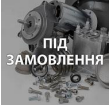

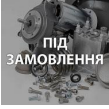

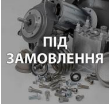
CRISTALLO 600 EVO 7GPM 1K (10004817)

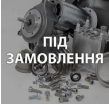
	24		11034281	ROTORE CAPS COVIM <i>ROTORE CAPS COVIM</i>
	25		129720102	TE SCREW M4X20 UNI 5739 ZNP <i>TE SCREW M4X20 UNI 5739 ZNP</i>
	26		11031024	SAFETY LEVER CAPS <i>LEVA SICUREZZA CAPS</i>
	27		NV01.006	ADHESIVE FOOT <i>ADHESIVE FOOT</i>
	28		9111.397	SPRING FOR TRAY /LEVER COIN RECOVE <i>MOLLA X BACINELLA/LEVA RECUP</i>
	29		U142.008	PANELVIT TSP 3,5X12 DIN 7505 AGAL <i>PANELVIT TSP 3,5X12 DIN 7505 A GAL</i>
	30		U140.017	PANELVIT TCB 3,0X20 DIN 7505 BGAL <i>PANELVIT TCB 3,0X20 DIN 7505 B GAL</i>
	31		11032699	SUPPORT EXTERNAL ROTOR <i>SUPPORT EXTERNAL ROTOR</i>
	32		U324.006	ШАЙБА M4 <i>NUT M4 FLANGED INDENTED BASE</i>
	33		11008644	LOCK PIN <i>LOCK PIN</i>
	34		12002031	KNOB D.18 M5X15 <i>KNOB D.18 M5X15</i>
	35		15004268	ADHESIVE HEIGHT CAPSULE CAFFITALY <i>ADHESIVE HEIGHT CAPSULE CAFFITALY</i>
	36		11032710	SUPPORT SHEET METAL CAPS <i>SUPPORT SHEET METAL CAPS</i>

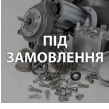
Model Machine

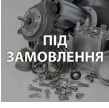
MACSAE304

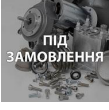
CRISTALLO 600 EVO 7GPM 1K (10004817)

	37		11031027	SUPPORTO ESTERNO ROTORE CAPS <i>SUPPORTO ESTERNO ROTORE CAPS</i>
	38		11031752	RATIOMOTOR 24V CAPS <i>RATIOMOTOR 24V CAPS</i>
	39		U207.004	PLAIN WASHER 4,3X16 UNI 6592 GAL <i>PLAIN WASHER 4,3X16 UNI 6592 GAL</i>
	40		NE17.013	CABLE RETAINER <i>CABLE RETAINER</i>
	41		11032533	ROTATION PIN <i>ROTATION PIN</i>
	42		U110.002	SCREW AUT.TCB 3,5X13 DIN 7981F <i>SCREW AUT.TCB 3,5X13 DIN 7981 F</i>
	43		11032534	SUPPORT CHANNEL LOADER <i>SUPPORTO CANALE CARICATORE</i>
	44		11031025	STIRRER DRAIN COVER <i>STIRRER DRAIN COVER</i>
	45		11031062	RATIOMOTOR 24V CAPS <i>RATIOMOTOR 24V CAPS</i>
	46		11031022	CHANNEL CONVEYOR CAPS <i>CHANNEL CONVEYOR CAPS</i>
	46		11032638	CHANNEL CONVEYOR CAPS CA <i>CHANNEL CONVEYOR CAPS CA</i>
	47		11031021	SWITCH CHANNEL CONVEYOR <i>SWITCH CHANNEL CONVEYOR</i>
	48		11031023	COVER CONVEYOR CAPS <i>COVER CONVEYOR CAPS</i>
	49		11031026	STIRRER DRAIN CAPS <i>STIRRER DRAIN CAPS</i>

Model Machine

MACSAE304

CRISTALLO 600 EVO 7GPM 1K (10004817)



50



U043.015

SCREW TCBC M5,0X12 UNI 7687 GALV.

SCREW TCBC M5,0X12 UNI 7687 GALV.



51

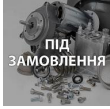

11032683

EXTENSION FOR CONTAINER

EXTENSION FOR CONTAINER

Model Machine

MACSAE304

CRISTALLO 600 EVO 7GPM 1K (10004817)

MACSAE304.T.0016



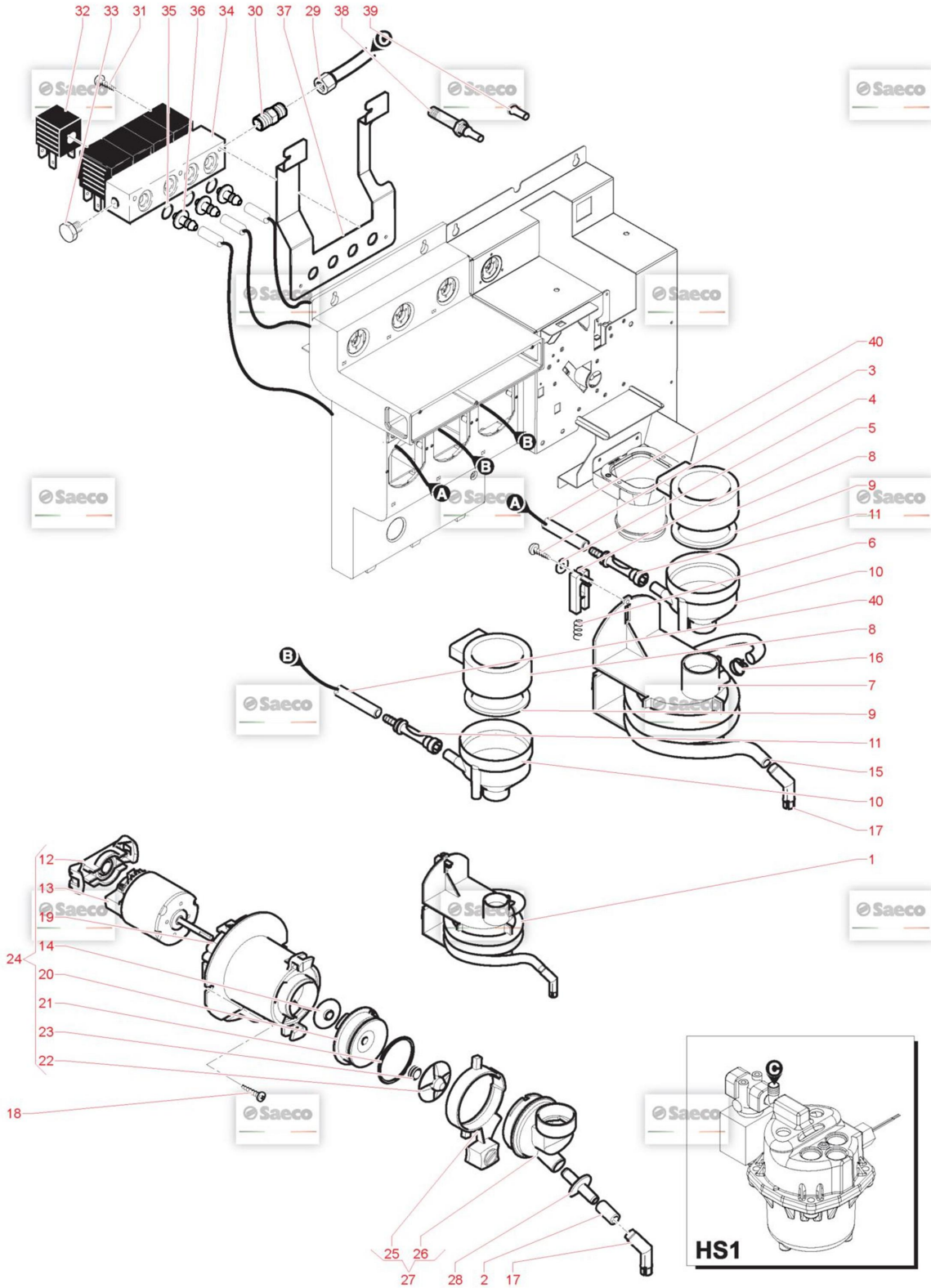























TAVOLA NR. 16 - ARTICOLO CRISTALLO 600 EVO 7GPM 1K (10004817)



Model Machine

MACSAE304





























CRISTALLO 600 EVO 7GPM 1K (10004817)

Web	Pos.	Foto	Item - Replace by	Description
				<i>Press - CTRL + CLICK go to item in a new window Натисніть - Ctrl + права кнопка миші щоб відкрити запчастину в новому вікні</i>
	1		1863.A10	ASS.MIXER FS400 ASS.MIXER A SPIRALE FS400
	2		9972.057	КОРИЧНЕВА ГУМОВА ТРУБКА 5X8 2 МЕТРИ TUBO SILICONE MARRON 5X8 L.2000 MM
	3		U116.005	SCREW AUT.PT TCB 3,0X8 WN 1441 VITE AUT.PT TCB 3,0X8 WN 1441 ZNP
	4		U207.004	PLAIN WASHER 4,3X16 UNI 6592 GAL PLAIN WASHER 4,3X16 UNI 6592 GAL
	5		9111.209.060	CURSOR FOR SPIRAL MIXER FIXING CURSOR FOR SPIRAL MIXER FIXING
	6		9111.211	SPRING FOR MIXER CURSOR MOLLA X CURSORE MISCELATORE
	7		9111.643.060	RAPID FIXING MIXER RAPID FIXING MIXER
	8		9111.010.060	LID FOR FUNNEL BROWN COPERCHIO X IMBUTO MARRON
	9		9111.011.060	SEAL FOR FUNNEL BROWN GUARNIZIONE X IMBUTO MARRON
	10		9111.009.060	FUNNEL FOR POWDERS BROWN IMBUTO X POLVERI MARRON
	11		1863.A07	ESPRESSO NOZZLE ASS.UGELLO ESPRESSO
	12		9111.771.270	MOTOR COUPLING ORANGE RAL MOTOR COUPLING ORANGE RAL
	13		9121.248.00P	MOTOP MIKCEPA '05 24V DC - M.B.T. COD. 912124800 SAECO 9121.248.00 MOTORE MIXER '05 24V DC - M.B.T.

Model Machine

MACSAE304

























CRISTALLO 600 EVO 7GPM 1K (10004817)

	14		9111.773.060	MOTOR PROTECTION RING <i>ANELLO PROTEZIONE MOTORE MIXER '05</i>
	15		9972.055	ТРУБКА СИЛІКОНОВА 8X12 2 МЕТРИ <i>SILICONE TUBE 8X12 L.2000MM</i>
	16		NV99.072	HOSE CLAMP D. 11.6/12.3 <i>HOSE CLAMP D. 11.6/12.3</i>
	17		9111.349	ELBOW DISPENSING NOZZLE <i>UGELLO EROGAZIONE GOMITO</i>
	18		U116.006	SCREW AUT.PT TCB 3,5X12 WN 1441 ZNP <i>VITE AUT.PT TCB 3,5X12 WN 1441 ZNP</i>
	19		9111.769.150	MIXER FLANGE <i>MIXER FLANGE</i>
	20		9111.770.060	COVER MIXER FLANGE <i>COVER MIXER FLANGE</i>
	21		NM03.012	OR ORM 0320-25 NBR <i>OR ORM 0320-25 NBR</i>
	22		9111.772.060	DISK FAN <i>VENTOLINA A DISCO MIXER '05</i>
	23		NM05.015	ПРОКЛАДКА V-RING 405 МІКСЕРА ДЛЯ КАВОМАШИН SAECO <i>V-RING MIXER '05</i>
	24		9110.160.06P	ДВИГУН МІКСЕРА ДЛЯ КАВОМАШИНИ SAECO 05 24V DC SAECO 9110.1... <i>ASS.MIXER '05 24V DC GROUP 500 SAECO</i>
	25		9111.230.270	MIXER LOCKING RING NUT ORANGERAL <i>GHIERA BLOCCAGGIO MIXER ARANCIO RAL</i>
	26		9111.227.060	MIXER CASING <i>CORPO MIXER</i>
	27		9110.027.060	MIX CASING ASS. <i>ASS.CORPO MIX SAECO CRISTALLO,ATLANTE,QUARZO,RUBINO</i>

Model Machine

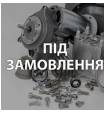
MACSAE304

CRISTALLO 600 EVO 7GPM 1K (10004817)

	28		9111.232.060	STD TUBE HOLDER SLEEVE <i>MANICOTTO PORTATUBO STANDARD</i>
	28		9111.233.060	DECAFF.TUBE HOLDER SLEEVE <i>MANICOTTO PORTATUBO DECAFFEINATO</i>
	29		11025295	TEFLON TUBE 3X6 L.170 1/8"-1/8 <i>TEFLON TUBE 3X6 L.170 1/8-1/8</i>
	30		9991.059	STRAIGHT BICONE CONNECTOR M 1/8X06 <i>STRAIGHT BICONE CONNECTOR M 1/8X06</i>
	31		129516803	SCREW TCB3,5X19 DIN 7981 NICK <i>SCREW TCB3,5X19 DIN 7981 NICK</i>
	32		20005373	SOLENOID X HS1 11023762 <i>SOLENOID X OLAB 24V DC 6000BH/BODN</i>
	33		12001169	ЛАТУННА ЗАГЛУШКА BRASS CAP 1/8 GAS CONICAL TEA <i>BRASS CAP 1/8 GAS CONICAL TEA</i>
	34		11011470	BLOCK 4 ELECTROVALVE DC OLAB TEA <i>BLOCK 4 ELECTROVALVE DC OLAB TEA</i>
	35		NM01.004	OR 2025 SILICONE <i>OR 2025 SILICONE</i>
	36		11011453	RUBBER HOLDER CONNECTOR TEA <i>RUBBER HOLDER CONNECTOR TEA</i>
	37	 ПІД ЗАМОВЛЕННЯ	11033756	ELECTROVALVE SUPPORT <i>ELECTROVALVE SUPPORT</i>
	38		20005374	ASS.NUCLEO FIS+MOB.X 11009225 <i>ASS.NUCLEUS 6000BH/BODN X 11009225</i>
	39		20007305	ЧАСТИНА ЕЛЕКТРОМАГНІТНОГО КЛАПАНА З ПОДВИЖНИМ СЕРДЕЧНИК... <i>SPARE EV MOBILE CORE 11023762</i>

Model Machine

MACSAE304

CRISTALLO 600 EVO 7ГРМ 1К (10004817)



40

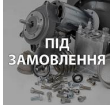

9972.246

СИЛІКОНОВА ТРУБКА 5X10 SAECO 265918 (2 МЕТРИ)

TUBO SILICONE 5X10 L.2000 MM

Model Machine

MACSAE304

CRISTALLO 600 EVO 7GPM 1K (10004817)

MACSAE304.T.0017

TAVOLA NR. 17 - ARTICOLO CRISTALLO 600 EVO 7GPM 1K (10004817)

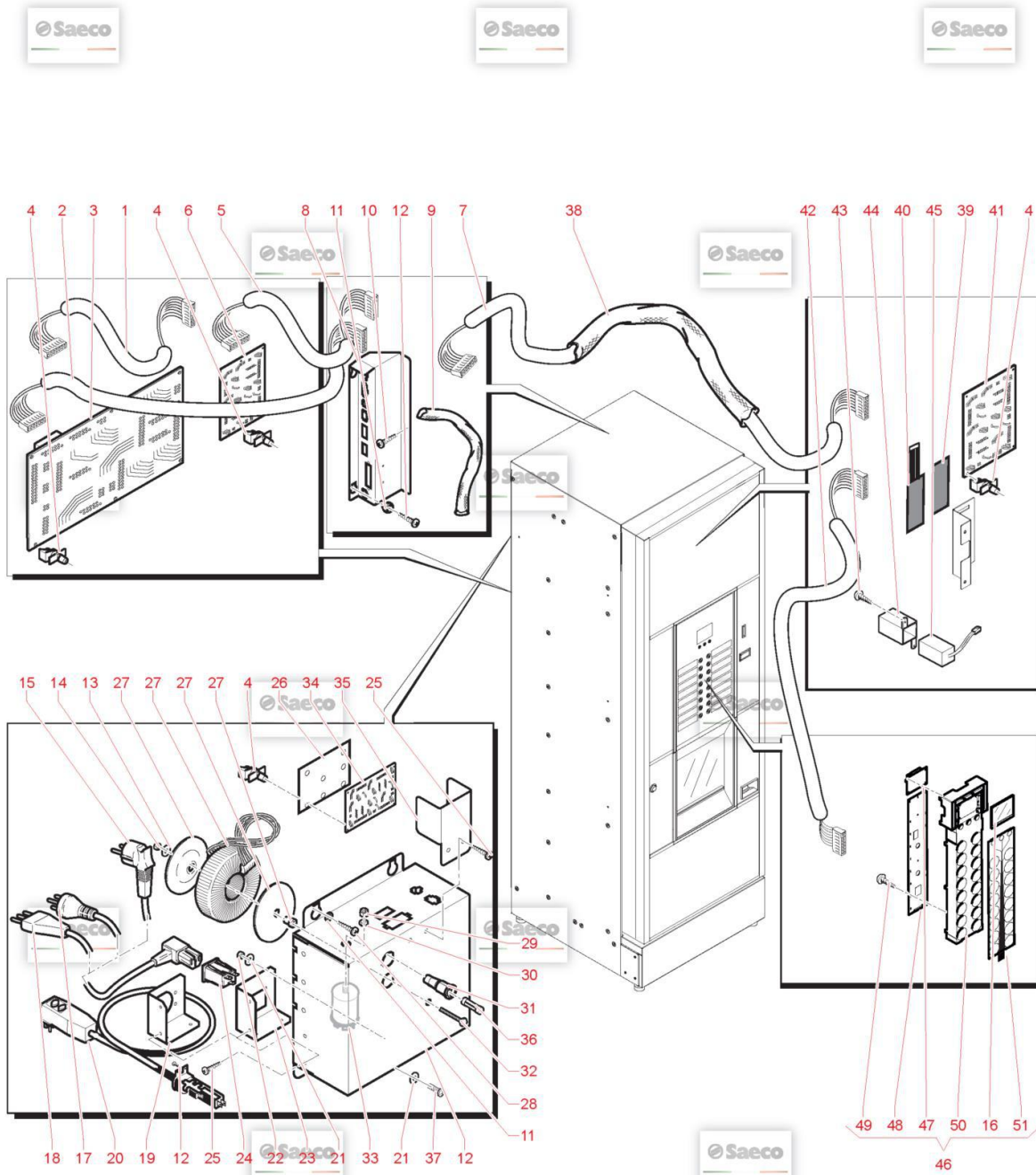

Model Machine

MACSAE304

CRISTALLO 600 EVO 7GPM 1K (10004817)

Web Pos. Foto Item - Replace by Description



Press - CTRL + CLICK go to item in a new window

Натисніть - Ctrl + права кнопка миші щоб відкрити запчастину в новому вікні



1



11033852

FLAT 24P PW BOARD / CAPS BOARD CRS EVO
FLAT 24P SCHEDA PW/SCHEDA CAPS CRS EVO



2



1863.604

HARNESS
FLAT CABLE



3



1863.636

POWER CARD FS400
SCHEDA POWER FS400



4



9111.402

SPACER FOR CARD
SPACER FOR CARD



5

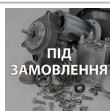

11033853

FLAT 24P EXTENSION CAPS BOARD CRS EVO
FLAT 24P EXTENSION CAPS BOARD CRS EVO



6

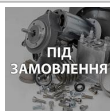

11033815

CAPSULE POWER BOARD
CAPSULE POWER BOARD



7

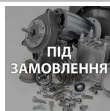

11033896

FLAT CABLE EXTEND CPU/IO CRS600 EVO
FLAT CABLE EXTEND CPU/IO CRS600 EVO



8

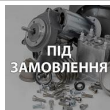

1863.070

BOX
BOX



9



11001619

CABLE TUBE L.520 MM
GUAINA X CAVI L.520 MM



10



U109.003

SCREW TCB 3,5X9,5 DIN 7981 C NICK
SCREW TCB 3,5X9,5 DIN 7981 C NICK



11

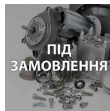

11011054

PIN FOR BOSS D.8
PIN FOR BOSS D.8



12



U110.005

SCREW AUT.TCB 3,9X9,5 DIN 7981F
VITE AUT.TCB 3,9X9,5 DIN 798



13

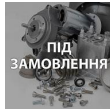

















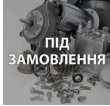

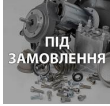

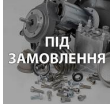

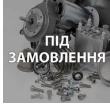

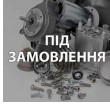

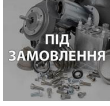
U207.013

PLAIN WASHER 6.5X18 UNI 6592 GALV
PLAIN WASHER 6.5X18 UNI 6592 GALV

Model Machine

MACSAE304

















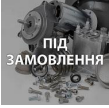





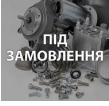

CRISTALLO 600 EVO 7GPM 1K (10004817)

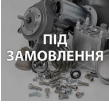
	14		U310.004	NUT SELF LOCK.M6 UNI 7473 <i>NUT SELF LOCK.M6 UNI 7473</i>
	15		NE01.050	CABLE SCHUKO WITH PLUG EN60320C1 <i>CAVO SCHUKO CON SPINA EN60320 C13</i>
	16		11032399	3,5" TFT DISPLAY 320X240 <i>3,5 TFT DISPLAY 320X240</i>
	17		NE01.053	CABLE AUSTRAL. +PLUG EN60320 C13 <i>CABLE AUSTRAL. +PLUG EN60320 C13</i>
	17		NE01.093	CABLE ARGENTINA + PLUG EN60320C13 <i>CABLE ARGENTINA + PLUG EN60320 C13</i>
	18		17800019	BLACK POWER CABLE BRAZIL L=1200 <i>BLACK POWER CABLE BRAZIL L=1200</i>
	18		NE01.051	CABLE SWITZERLAND WITH PLUG EN603 <i>CABLE SWITZERLAND WITH PLUG EN603</i>
	19		11003906	USA CABLE SUPPORT ELECTRONIC PARTS BOX <i>USA CABLE SUPPORT ELECTRONIC PARTS BOX</i>
	20		11012009	POWER CABLE USA 3 POLE 15A X GFC8 <i>POWER CABLE USA 3 POLE 15A X GFC8</i>
	21		U208.003	TOOTHED WASHER 5,1X9 BRU <i>TOOTHED WASHER 5,1X9 BRU</i>
	22		U302.003	METALIEVA GAIKA M4 UNI 5588 ZNP <i>DADO ESAGONALE M4 UNI 5588 ZNP</i>
	23		11000546	POWER CONNECTOR SUPPORT <i>SQUADRETTA X PRESA VASCHETTA</i>
	24		187850400	TRIPOLE SOCKET SELF-LOCKING <i>TRIPOLE SOCKET SELF-LOCKING</i>
	25		U110.003	SCREW AUT.TCB 3,5X9,5 DIN 7981F <i>VITE AUT.TCB 3,5X9,5 DIN 798</i>

Model Machine

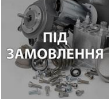
MACSAE304













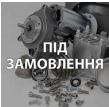

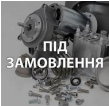











CRISTALLO 600 EVO 7GPM 1K (10004817)

	26		11012747	CARD PROTECTION LED ATLANTE <i>CARD PROTECTION LED ATLANTE</i>
	27		NE19.023	TOROIDAL TRANSFORMER COMBI 240V <i>TOROIDAL TRANSFORMER COMBI 240V</i>
	27		NE19.028	TOROIDAL TRANSFORMER FS 400 <i>TRASFORMATORE TOROIDALE FS 400</i>
	28		1863.045	ASPIRATION CASING FOR MIXER <i>ASPIRATION CASING FOR MIXER</i>
	29		U302.007	NUT HEXAGONAL M8 UNI 5588 <i>NUT HEXAGONAL M8 UNI 5588</i>
	30		U208.009	TOOTHED WASHER 8,4X15 UNI 3703 <i>TOOTHED WASHER 8,4X15 UNI 3703</i>
	31		NE13.016	FUSE HOLDER WITH SCREW ON CAP <i>PORTAFUSIBILE CON TAPPO A VITE</i>
	32		U005.013	SCREW TE M6,0X70 UNI 5739 GALV. <i>SCREW TE M6,0X70 UNI 5739 GALV.</i>
	33		184651500	LOCKING SCREW ANTIDISTURB FILTER 16A <i>LOCKING SCREW ANTIDISTURB FILTER 16A</i>
	34		11030270	ATLANTE LED POWER SUPPLY <i>ATLANTE LED POWER SUPPLY</i>
	35		11003867	SAFETY PLATE FOR EL.BOX CONNECTOR <i>SAFETY PLATE FOR EL.BOX CONNECTOR</i>
	36		NE13.002	FUSE 6,3X32 8A 250V DELAYED <i>FUSE 6,3X32 8A 250V DELAYED</i>
	36		NE13.081	FUSE 6,3X32 16A 250V DELAYED UL <i>FUSIBILE 6,3 X 32 15A 250V RITARD UL SOLO UL</i>

Model Machine

MACSAE304

CRISTALLO 600 EVO 7GPM 1K (10004817)

	37		12002039	SCREW TCBD TORX 20 M4X12 ZN-B VITE TCBD TORX 20 M4X12 ZN-B
	38		11033879	CABLE TUBE L.650MM CABLE TUBE L.650MM
	39		0875.990	TOUCH PANEL PLATE TOUCH PANEL PLATE
	40		0875.741	TOUCH PANEL TOUCH PANEL
	41		11033307	AS.CPU+SW CRISTALLO EVO AS.CPU+SW CRISTALLO EVO
	42		11033778	HARNESS CPU BOARD KEYBOARD CAPACITIVE HARNESS CPU BOARD KEYBOARD CAPACITIVE
	43		U116.005	SCREW AUT.PT TCB 3,0X8 WN 1441 VITE AUT.PT TCB 3,0X8 WN 1441 ZNP
	44		9991.140.050	IMPULSECOUNTERHOLDER KEISU GX-06R PORTA CONTAIMPULSI KEISU GX-
	45		NE13.025.00P	IMPULSE COUNTER KEISU GX-06R 24V CONTAIMPULSI KEISU GX-06R 24
	46		11032875	ILLUMINATOR 16+3 LED FS4N ILLUMINATOR 16+3 LED FS4N
	47		11032383	HW INTERF. NEW TFT DISPLAY UMSH-8252MD-T SCHEMA INTERF. DISPLAY TFT UMS H-8252MD-T CRISTALLO400/600/PHE...
	48		11032885	SCHEMA LEDS CAPACITIVA SCHEMA LEDS CAPACITIVA
	49		U116.006	SCREW AUT.PT TCB 3,5X12 WN 1441 ZNP VITE AUT.PT TCB 3,5X12 WN 1441 ZNP
	50		11032820	DISPLAY / LED SUPPORT FS4N DISPLAY / LED SUPPORT FS4N

Model Machine

MACSAE304

CRISTALLO 600 EVO 7GPM 1K (10004817)



51

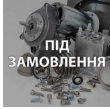

11032991

CAPACITIVE ADHESIVE CIRCUIT 19KEYS

CAPACITIVE ADHESIVE CIRCUIT 19 KEYS

Model Machine

MACSAE304

CRISTALLO 600 EVO 7FPM 1K (10004817)

MACSAE304.T.0018

TAVOLA NR. 18 - ARTICOLO CRISTALLO 600 EVO 7FPM 1K (10004817)

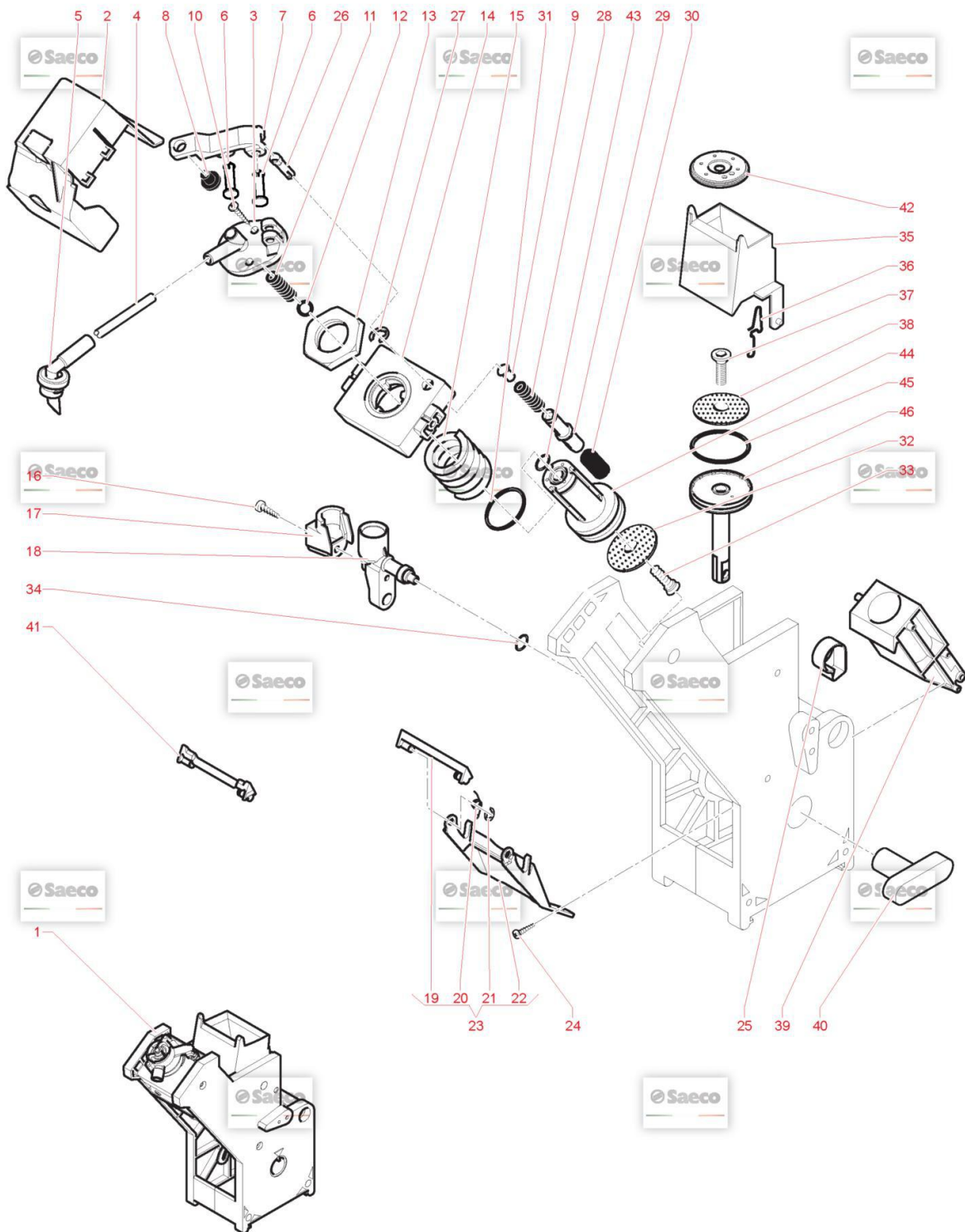

Model Machine

MACSAE304

CRISTALLO 600 EVO 7GPM 1K (10004817)

Web Pos. Foto Item - Replace by Description



Press - CTRL + CLICK go to item in a new window
Натисніть - Ctrl + права кнопка миші щоб відкрити запчастину в новому вікні



1



11030408

BREWING UNIT ASS. 7GR GRAN GUSTO
ASS. GRUPPO CAFFE 6/8GR NEW



2



11029737

PROTECTION VALVE
PROTEZIONE VALVOLA SFIATO GRUPPO CAFFE



3



11029311

COVER BALL VALVE
COPERCHIO VALVOLA SFERA



4

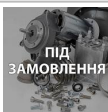

9972.345

SILICONE TUBE 3,5X9 L.340MM
SILICONE TUBE 3,5X9 L.340MM



5



11033574

COFFEE NOZZLES
COFFEE NOZZLES



6



11030836

ШПЛИНТ ФІКСАЦІЇ СУППОРТУ КЛАПАНА
PIN FIXING VALVE SUPPORT



7



11029312

BREATHER VALVE CLOSED
CHIUSURA VALVOLA SFIATO



8



NV01.009

RUBBER BUFFER
GOMMINO PARACOLPI



9



9161.320

VALVE FOR UNIT
VALVOLA X GRUPPO CAFFE'



10



U109.006

SCREW AUT.TCB 2,2X9,5 DIN 7981C
VITE AUT.TCB 2,2X9,5 DIN 7981 C NIK



11



126771918

SS COFFEE UNIT CONTERPISTON SPRING SMART
MOLLA CONTROPIST. GRUP. SMART INOX



12



12001811

SPHERE TEFLON D.4,5
SFETA D.4.5 TEFLON X VALVOLA GRUPPO CAFF



13































11029317

NUT SEAL PISTON MOVABLE
DADO TENUTA CONTROPISTONE MOBILE

Model Machine

MACSAE304



























CRISTALLO 600 EVO 7GPM 1K (10004817)

	14		11029316	FLANGE FOR CUPHOLDER <i>FLANGIA X PISTONE MOBILE</i>
	15		11029308	SPRING FOR MOVABLE COUNTERPISTON <i>MOLLA X CONTROPISTONE MOBILE</i>
	16		129512921	SCREW TCB TORX 10 AB 2,9X13 SHEET SS <i>SCREW TCB TORX 10 2,9X13 SHEET SS</i>
	17		11010013	CARTER FOR MUFF PREHEATING UNIT <i>CARTE X MANICOTTO GRUPPO PRERISCALDO</i>
	18		11005371	UNIT COFFEE MUFF <i>MANICOTTO GRUPPO CAFFE' UNIT COFFEE MUFF</i>
	19		9111.537.060	BROWN SCRAPER COFFEE GROUP <i>BROWN SCRAPER COFFEE GROUP</i>
	20		9111.520	SPRING FOR SCRAPER SECTION 0.6 <i>SPRING FOR SCRAPER SECTION 0.6</i>
	21		U701.006	ФІКСУЮЧА СКОБА 3,2 (ЗАПІЗО) SAECO <i>ANELLO ELASTICO 3,2</i>
	22		9111.539.060	FORK FOR SCRAPER <i>FORCELLA PER RASCHIATORE</i>
	23		9110.067.060	SCRAPER ASS.FOR CAPPUCINAT. TUBE <i>ASS.RASCHIATORE X SG500/700</i>
	24		U110.013	БОЛТ МЕТАЛЕВИЙ 3,9X6,5 DIN 7981 F <i>SCREW AUT.TCB 3,9X6,5 DIN 7981 F</i>
	25		11030309	RING FOR CAM <i>ANELLO X CAMMA PISTONE</i>
	26		11029313	CURSOR COMPENSATOR VALVE VENT <i>CURSORE COMPENSATORE X VALVOLA SFIATO</i>
	27		U701.007	ЕЛАСТИЧНЕ КІЛЬЦЕ 6 UNI 7434 (ЗАПІЗО) <i>ЕЛАСТИЧНЕ КІЛЬЦЕ 6 UNI 7434 (ЗАПІЗО)</i>

Model Machine

MACSAE304







CRISTALLO 600 EVO 7GPM 1K (10004817)

	28		11029310	SPRING FOR RELIEF VALVE <i>MOLLA COMPENSATRICE X VALVOLA SFIATO</i>
	29		11029314	CURSOR FOR VALVE VENT <i>CURSORE X VALVOLA SFIATO</i>
	30		11029309	SPRING FOR RELIEF VALVE <i>MOLLA X VALVOLA SFIATO</i>
	31		140322061	O-RING 4112 EPDM <i>OR 4112 IN EPDM</i>
	32		11012630	PERCOLATOR D.34 <i>PERCOLATOR D.34</i>
	33		U044.009	SS SCREW TSPC M3,0X8 UNI 7688 <i>VITE TSCP M3,0X8 UNI 7688 INO</i>
	34		140321462	O-RING 2018 SILICONE <i>OR 2018 IN SILICONE</i>
	35		322001201	MOBILE SCRAPER BROWN NARROW <i>MOBILE SCRAPER BROWN NARROW</i>
	36		9161.425	SPRING FOR SCRAPER <i>SPRING FOR SCRAPER</i>
	37		129851921	TSP SCREW M3X6 UNI 7688 SS <i>TSP SCREW M3X6 UNI 7688 SS</i>
	38		324000200	SS PERCOLATOR D=34 FOR UNIT <i>SS PERCOLATOR D=34 FOR UNIT</i>
	39		222711101	BROWN GROUND COFF.CONTAINER D=36 ASSY. <i>BROWN GROUND COFF.CONTAINER D=36 ASSY.</i>
	40		9161.021.060	KEY FOR BREW UNIT BROWN <i>CHIAVE X GRUPPO CAFFE' MARRO</i>

Model Machine

MACSAE304

CRISTALLO 600 EVO 7GPM 1K (10004817)

	41		11012957	SCRAPER FOR COFFEE UNIT 7-9GR. <i>SCRAPER FOR COFFEE UNIT 7-9GR.</i>
	42		11030122	SPACE <i>SPACE</i>
	43		NM01.029	OR ORM 0100-15 SILICONE <i>OR ORM 0100-15 SILICONE</i>
	44		11029878	ASS.CONTROPISTONE MOBILE <i>ASS.CONTROPISTONE MOBILE</i>
	45		140322500	ПРОКЛАДКА O-RING 2118 SH70 BIANCHI 36363116-01, SAECO 140322500 <i>OR 2118 IN NITRIL RUBBER</i>
	46		11029879	ПОРШЕНЬ РОБОЧОГО БЛОКУ X 7 ГРАМ <i>ASS.PISTONE X GRUPPO CAFFE'</i>

Model Machine

MACSAE304

CRISTALLO 600 EVO 7GPM 1K (10004817)

MACSAE304.T.0019

TAVOLA NR. 19 - ARTICOLO CRISTALLO 600 EVO 7GPM 1K (10004817)

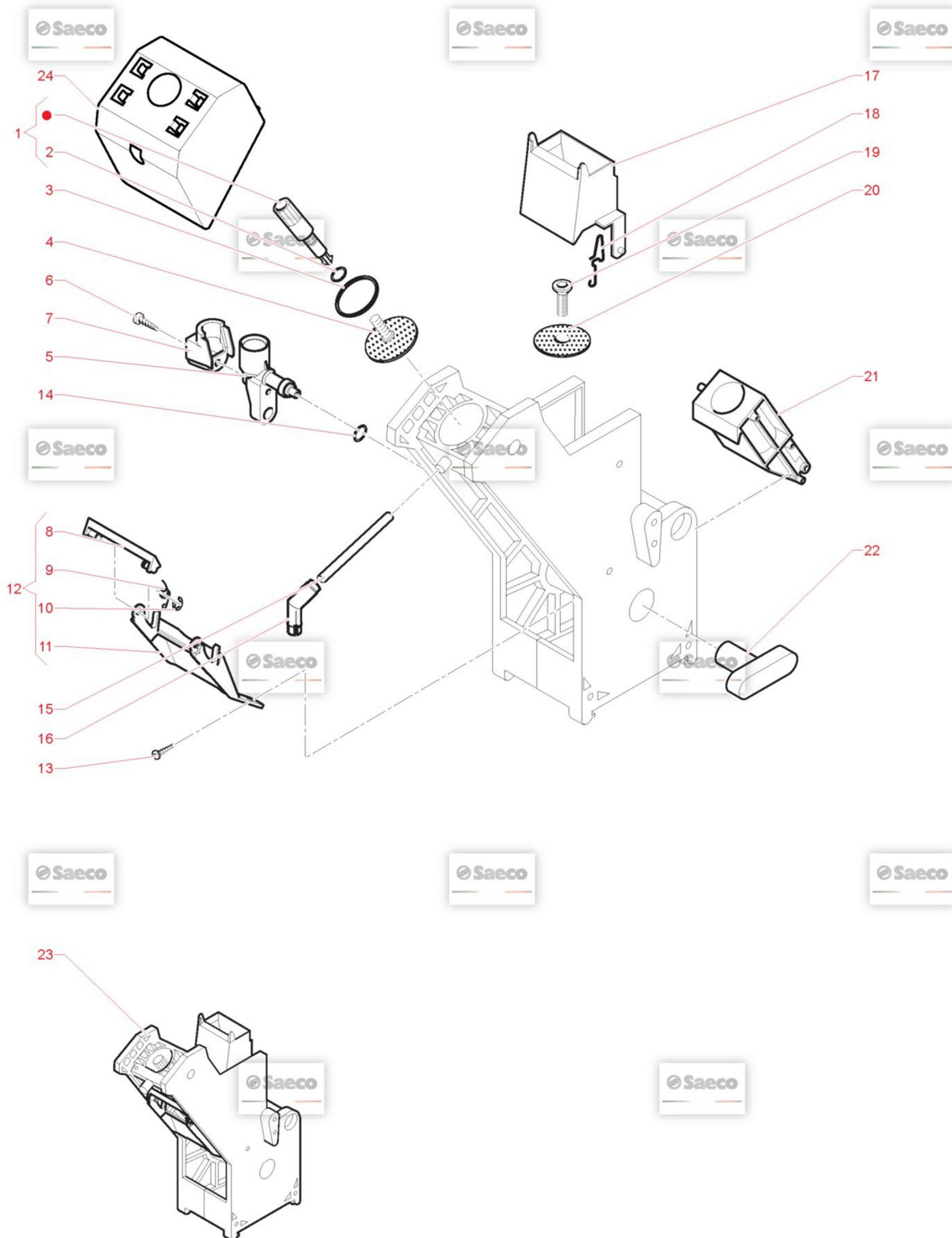

Model Machine

MACSAE304

CRISTALLO 600 EVO 7GPM 1K (10004817)

Web Pos. Foto Item - Replace by Description



Press - CTRL + CLICK go to item in a new window
Натисніть - Ctrl + права кнопка миші щоб відкрити запчастину в новому вікні



1



9169.A14.150

PIN FOR PERCOLATOR GREY
ASS.PERNO X DOCCIA COMPLETO GRIGIO



2



NM02.006

OR R5 TERMOIL
OR R5 EPDM



3



NM01.044

OR ORM 0320-40 SILICONE PTFE/FDA
OR ORM 0320-40 SILICONE PTFE



4



9161.036

UPPER PERCOLATOR FOR UNIT
DOCCIA SUPERIORE X GRUPPO



5



11005371

UNIT COFFEE MUFF
MANICOTTO GRUPPO CAFFE' UNIT COFFEE MUFF



6



129512921

SCREW TCB TORX 10 AB 2,9X13 SHEET SS
SCREW TCB TORX 10 2,9X13 SHEET SS



7



11010013

CARTER FOR MUFF PREHEATING UNIT
CARTE X MANICOTTO GRUPPO PRERISCALDO



8



9111.537.150

GREY SCRAPER COFFEE GROUP
GREY SCRAPER COFFEE GROUP



9



9111.520

SPRING FOR SCRAPER SECTION 0.6
SPRING FOR SCRAPER SECTION 0.6



10



U701.006

ФІКСУЮЧА СКОБА 3,2 (ЗАЛІЗО) SAECO
ANELLO ELASTICO 3,2



11



9111.539.150

FORK FOR SCRAPER
FORCELLA PER RASCHIATORE



12



9110.067.150

SCRAPER ASS.FOR CAPPUCCINAT. TUBE
ASS.RASCHIATORE X SG500/700



13

























U110.013

БОЛТ МЕТАЛЕВИЙ 3,9X6,5 DIN 7981 F
SCREW AUT.TCB 3,9X6,5 DIN 7981 F

Model Machine

MACSAE304

CRISTALLO 600 EVO 7GPM 1K (10004817)

	14		140321462	O-RING 2018 SILICONE <i>OR 2018 IN SILICONE</i>
	15		9972.057	КОРИЧНЕВА ГУМОВА ТРУБКА 5X8 2 МЕТРИ <i>TUBO SILICONE MARRON 5X8 L.2000 MM</i>
	16		9111.349	ELBOW DISPENSING NOZZLE <i>UGELLO EROGAZIONE GOMITO</i>
	17		322001259	ПЛАСТИКОВА ВОРНОКА ПОДАЧИ КАВИ (ПЛАСТИК) ЧОРНИЙ <i>MOBILE SCRAPER GREY NARROW</i>
	18		9161.425	SPRING FOR SCRAPER <i>SPRING FOR SCRAPER</i>
	19		129851921	TSP SCREW M3X6 UNI 7688 SS <i>TSP SCREW M3X6 UNI 7688 SS</i>
	20		9161.037	LOWER PERCOLATOR FOR UNIT <i>DOCCIA INFERIORE X GRUPPO</i>
	21		11002626	ASS. COFFEE CONTAINER GREY 9 GR. <i>ASS. COFFEE CONTAINER GREY 9 GR.</i>
	22		9161.021.060	KEY FOR BREW UNIT BROWN <i>CHIAVE X GRUPPO CAFFE' MARRO</i>
	23		11005422	ЗАВАРЮВАЛЬНИЙ БЛОК 9GR SAECO 996530002882 <i>GRUPPO CAFFE' 9GR CRISTALLO 600</i>
	24		11013053	CARTER FOR DOSER UNIT <i>CARTER FOR DOSER UNIT</i>

Model Machine

MACSAE304

CRISTALLO 600 EVO 7GPM 1K (10004817)

MACSAE304.T.0020



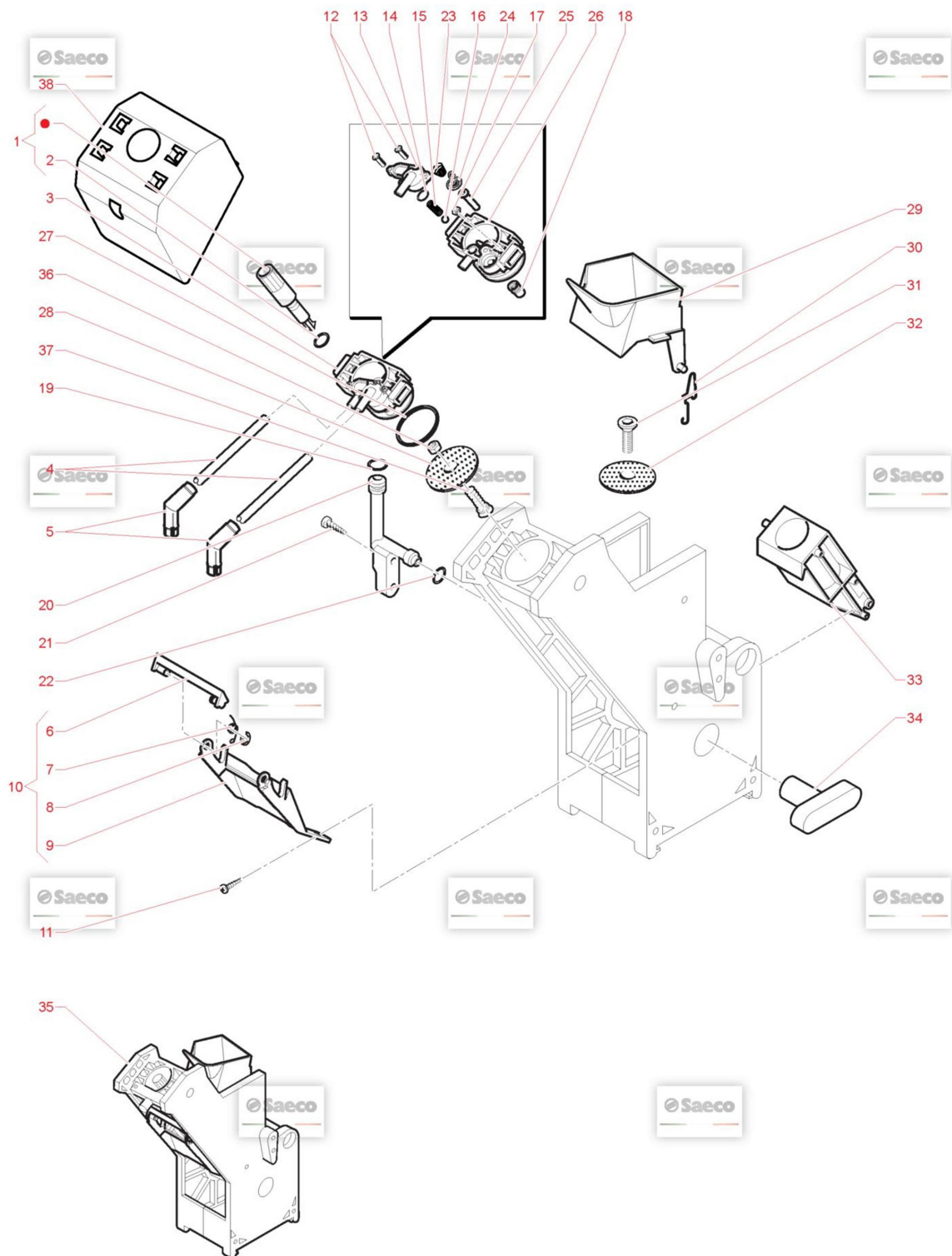























TAVOLA NR. 20 - ARTICOLO CRISTALLO 600 EVO 7GPM 1K (10004817)



Model Machine

MACSAE304











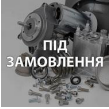







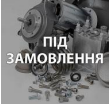



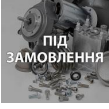



CRISTALLO 600 EVO 7GPM 1K (10004817)

Web	Pos.	Foto	Item - Replace by	Description
				<i>Press - CTRL + CLICK go to item in a new window Натисніть - Ctrl + права кнопка миші щоб відкрити запчастину в новому вікні</i>
	1		9169.A14.150	PIN FOR PERCOLATOR GREY ASS.PERNO X DOCCIA COMPLETO GRIGIO
	2		NM02.006	OR R5 TERMOIL OR R5 EPDM
	3		11007343	НОСИК В ЗБОРІ 10 ГРАМ ASS.COUNTERPISTON FRESH-BREW
	4		9972.057	КОРИЧНЕВА ГУМОВА ТРУБКА 5X8 2 МЕТРИ TUBO SILICONE MARRON 5X8 L.2000 MM
	5		9111.349	ELBOW DISPENSING NOZZLE UGELLO EROGAZIONE GOMITO
	6		9111.537.150	GREY SCRAPER COFFEE GROUP GREY SCRAPER COFFEE GROUP
	7		9111.520	SPRING FOR SCRAPER SECTION 0.6 SPRING FOR SCRAPER SECTION 0.6
	8		U701.006	ФІКСУЮЧА СКОБА 3,2 (ЗАПІЗО) SAECO ANELLO ELASTICO 3,2
	9		9111.539.150	FORK FOR SCRAPER FORCELLA PER RASCHIATORE
	10		9110.067.150	SCRAPER ASS.FOR CAPPUCCINAT. TUBE ASS.RASCHIATORE X SG500/700
	11		U110.013	БОЛТ МЕТАЛЕВИЙ 3,9X6,5 DIN 7981 F SCREW AUT.TCB 3,9X6,5 DIN 7981 F
	12	 ПІД ЗАМОВЛЕННЯ	U109.030	САМОРІЗ AUT.TCB 2,9X16 DIN 7981 C SCREW AUT.TCB 2,9X16 DIN 7981 C
	13		11003470	КРИШКА НОСИКА LID X COUNTERPISTON FRESH-BREW

Model Machine

MACSAE304

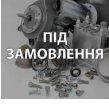



















CRISTALLO 600 EVO 7ГРМ 1К (10004817)

	14		NM02.013	OR ORM 0080-15 TERMOIL <i>OR ORM 0080-15 TERMOIL</i>
	15		11028830	ПРУЖИНКА ДЛЯ FS400 ПІД ШАРИК ПОРШНЯ <i>SPRING FOR FS400 COVER CHASSIS</i>
	16		12001650	SPHERE TEFLON D.5 <i>SPHERE TEFLON D.5</i>
	17		U302.003	МЕТАЛЕВА ГАЙКА М4 UNI 5588 ZNP <i>DADO ESAGONALE M4 UNI 5588 ZNP</i>
	18		11003472	RUBBER X UNIT FRESH-BREW <i>RUBBER X UNIT FRESH-BREW</i>
	19		140320461	OR ORM 0080-20 TERMOIL <i>OR ORM 0080-20 IN TERMOIL</i>
	20		322000559	WATER FLOW PISTON GREY <i>WATER FLOW PISTON GREY</i>
	21		129512921	SCREW TCB TORX 10 AB 2,9X13 SHEET SS <i>SCREW TCB TORX 10 2,9X13 SHEET SS</i>
	22		140321462	O-RING 2018 SILICONE <i>OR 2018 IN SILICONE</i>
	23		11002603	SPING FOR MEMBRANE <i>SPING FOR MEMBRANE</i>
	24		11002625	MEMBRANE <i>MEMBRANE</i>
	25		11003471	PIN FOR MEMBRANE FRESH-BREW <i>PIN FOR MEMBRANE FRESH-BREW</i>
	26		11003469	COUNTERPISTON FRESH-BREW <i>COUNTERPISTON FRESH-BREW</i>
	27		NM01.044	OR ORM 0320-40 SILICONE PTFE/FDA <i>OR ORM 0320-40 SILICONE PTFE</i>

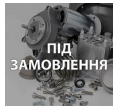
Model Machine

MACSAE304

CRISTALLO 600 EVO 7GPM 1K (10004817)

	28		9161.167	СИТО МЕТАЛЕВЕ D=35,8 SAECO 11008362 <i>PERCOLATOR D.35,8</i>
	29		11003529	HOPPER DOSER UNIT FRESH BREW <i>HOPPER DOSER UNIT FRESH BREW</i>
	30		126836618	SPRING H=28 NEW FOR SCRAPER <i>MOLLA H=28 NEW X RASCHIATORE</i>
	31		129851921	TSP SCREW M3X6 UNI 7688 SS <i>TSP SCREW M3X6 UNI 7688 SS</i>
	32		9161.037	LOWER PERCOLATOR FOR UNIT <i>DOCCIA INFERIORE X GRUPPO</i>
	33		11002626	ASS. COFFEE CONTAINER GREY 9 GR. <i>ASS. COFFEE CONTAINER GREY 9 GR.</i>
	34		9161.021.060	KEY FOR BREW UNIT BROWN <i>CHIAVE X GRUPPO CAFFE' MARRO</i>
	35	 ПІД ЗАМОВЛЕННЯ	11007283	BREW UNIT 10GRAMS FRESH BREW <i>BREW UNIT 10GRAMS FRESH BREW</i>
	36		U301.003	ГАЙКА HEXAGONAL M3 UNI 5587 <i>NUT HEXAGONAL M3 UNI 5587</i>
	37		129852821	TSP SCREW M3X14 UNI 7688 SS <i>TSP SCREW M3X14 UNI 7688 SS</i>
	38		11013053	CARTER FOR DOSER UNIT <i>CARTER FOR DOSER UNIT</i>

Model Machine

MACSAE304

CRISTALLO 600 EVO 7FPM 1K (10004817)

MACSAE304.T.0021

TAVOLA NR. 21 - ARTICOLO CRISTALLO 600 EVO 7FPM 1K (10004817)

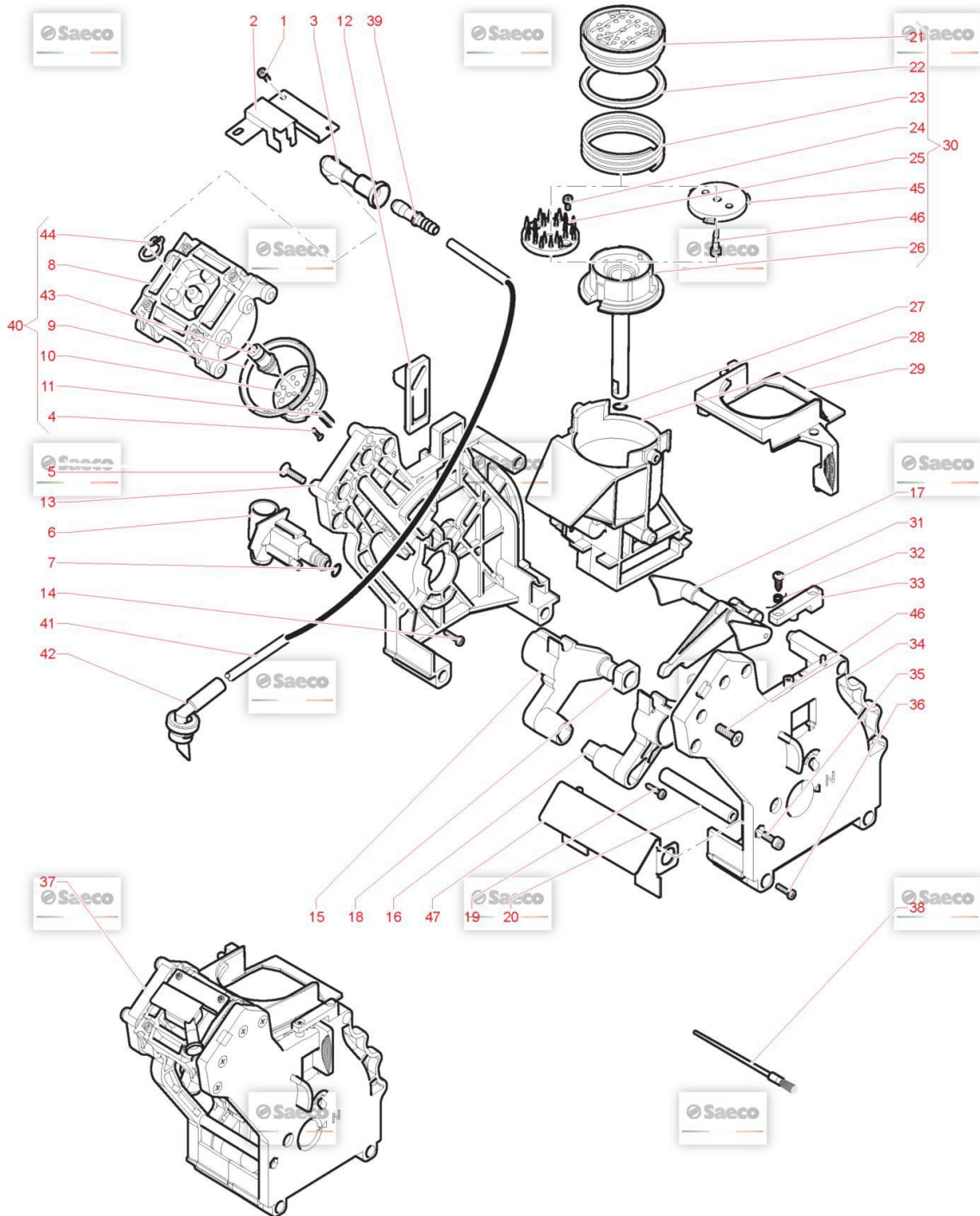

Model Machine

MACSAE304

CRISTALLO 600 EVO 7GPM 1K (10004817)

Web Pos. Foto Item - Replace by Description



Press - CTRL + CLICK go to item in a new window
Натисніть - Ctrl + права кнопка миші щоб відкрити запчастину в новому вікні



1



129512921

SCREW TCB TORX 10 AB 2,9X13 SHEET SS
SCREW TCB TORX 10 2,9X13 SHEET SS



2

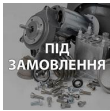

11031906

PLATE
PLATE



3

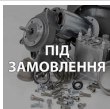

11004586

BLK COFFEE OUTLET CONVEYOR OCS
BLK COFFEE OUTLET CONVEYOR OCS



3

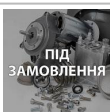

9161.356

BLK COFFEE OUTLET CONVEYOR LAV.
BLK COFFEE OUTLET CONVEYOR LAV.



4

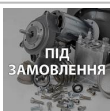

129912621

SCREW PT KB 30X8 WN 1413 INOXA2
SCREW PT KB 30X8 WN 1413 INOX A2



5

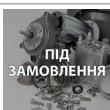

129911721

SCREW TSP TORX 4X16 PLAST STEEL
SCREW TSP TORX 4X16 PLAST STEEL



6



9161.064.150

ВХІДНИЙ КЛАПАН ЗАВАРЮВАЛЬНОГО БЛОКУ КАВОВАРКИ SAECO ПРО...
MANICOTTO ENTRATA ACQUA GRUP.CAF.GRIGIO CON OR NM02.007 - F...



7



NM02.007

OR 2025 IN TERMOIL
OR 2025 TERMOIL



8

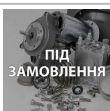

11013418

BLK COFF.CAPSULE FIXED CONTAINER V3 LAV.
BLK COFF.CAPSULE FIXED CONTAINER V3 LAV.



8

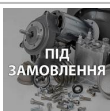

11034351

BLK COFF.CAPSULE FIXED CONTAINER
CONT.FISSO CAPS LAVORATO CO BLK



8



421941306941

CONT.FISSO CAPS.CAF.ATL700 CAGRI.
GREY COFFEE CAPS.FIXED CONTAINER ATL700



9



11031760

SEAL FOR BREW UNIT CAPS
SEAL FOR BREW UNIT CAPS



9

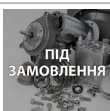











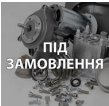

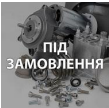













421941306911

SEAL FOR BREW UNIT CAPS CA
SEAL FOR BREW UNIT CAPS CA

Model Machine

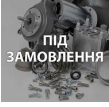
MACSAE304

















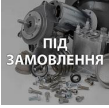





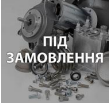

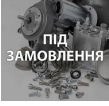
CRISTALLO 600 EVO 7GPM 1K (10004817)

	10		11031226	PIERCER GROUP CAPS <i>PIERCER GROUP CAPS</i>
	11		126773518	SS SPRING FOR COFFEE CAPSULE LAV. <i>SS SPRING FOR COFFEE CAPSULE LAV.</i>
	11		421941306921	SPRING FOR STEEL PIERCE BU CAPSULE CA <i>MOLLA X FORATORE CA</i>
	12		9161.373.150	GREY BREW UNIT COUPLING PLATESMART <i>GREY BREW UNIT COUPLING PLATE SMART</i>
	13		11013396	BLACK BREW UNIT REAR PLATE V3LAV. <i>BLACK BREW UNIT REAR PLATE V3 LAV.</i>
	14		12000550	CAMOPI3 TCB TORX 10 3X25 PLAST.SS <i>SCREW TCB TORX 10 3X25 PLAST.SS</i>
	15		120080722	ALUM.FEMALE ELBOW SHAFT <i>ALUM.FEMALE ELBOW SHAFT</i>
	16		120080622	ALUM.MALE ELBOW SHAFT <i>ALUM.MALE ELBOW SHAFT</i>
	17		11032146	GREY BREW UNIT CONNECTING RODCAPS <i>GREY BREW UNIT CONNECTING ROD CAPS</i>
	18		9161.094.050	BLACK BREW UNIT DRILLED BLOCK <i>BLACK BREW UNIT DRILLED BLOCK</i>
	19		129574421	SCREW TCB PH/TT 4X20 UNI 8112ST.ST <i>SCREW TCB PH/TT 4X20 UNI 8112 ST.ST</i>
	20		9161.298	BRASS SPACER <i>BRASS SPACER</i>
	21		11011770	CASING TO MOVABLE DRILLING PLATE V3 LAV. <i>CORPO A PIATTEL.MOBILE FORATO V3 LAV.NER</i>
	21		142906059	CASING TO MOVABLE DRILLING PLATE <i>CASING TO MOVABLE DRILLING PLATE</i>

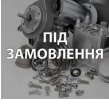
Model Machine

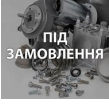
MACSAE304

















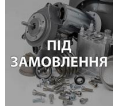

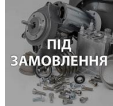

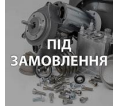

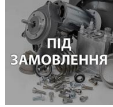

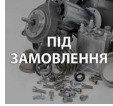

CRISTALLO 600 EVO 7GPM 1K (10004817)

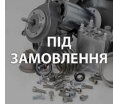
	22		11026624	LIP SEAL FOR CAPS.EXPELLER PISTON V4 LAV <i>LIP SEAL FOR CAPS.EXPELLER PISTON V4 LAV</i>
	22		145855700	LIP SEAL FOR EXPELLER PISTON OCS <i>LIP SEAL FOR EXPELLER PISTON OCS</i>
	23		126772418	COFF.CAPSULE EXPELLER PISTON SPRING LAV. <i>COFF.CAPSULE EXPELLER PISTON SPRING LAV.</i>
	23		126774118	SPIRAL SPRING FOR PISTON EXPELLER <i>SPIRAL SPRING FOR PISTON EXPELLER</i>
	24		129910921	SCREW TCB TORX 10 3X10 SS <i>SCREW TCB TORX 10 3X10 SS</i>
	25		149198000	COFFEE CAPS.LOWER DRILLING SUPPORT LAV. <i>COFFEE CAPS.LOWER DRILLING SUPPORT LAV.</i>
	26		229211859	COFFEE CAPSULE EXPELLER PISTONLAV. <i>COFFEE CAPSULE EXPELLER PISTON LAV.</i>
	26		229211959	COFFEE CAPSULE EXPELLER PISTONOCS <i>COFFEE CAPSULE EXPELLER PISTON OCS</i>
	27		NM02.018	OR ORM 0090-25 TERMOIL <i>OR ORM 0090-25 TERMOIL</i>
	28		421941306881	MOBILE CONT. BU CAPS V3 ATL 700 ASSY <i>MOBILE CONT. BU CAPS V3 ATL 700 ASSY</i>
	28		421941306901	MOBILE CONTAINER BU OCS CAPS ATL700 ASSY <i>ASS.CONT.MOBILE GRUPPO CAPS ATL700 GRY</i>
	29		11031018	HOPPER COFFEE GROUP <i>HOPPER COFFEE GROUP</i>
	30		11026626	PISTON EXPELLER COFFEE CAPSULEV4 ASSY. <i>PISTON EXPELLER COFFEE CAPSULE V4 ASSY.</i>

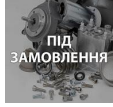
Model Machine

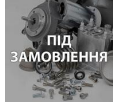
MACSAE304

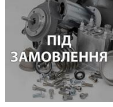







CRISTALLO 600 EVO 7GPM 1K (10004817)

	30		227661000	PISTON AS.EXPELLER COFF.CAPSULE OCS ASSY <i>PISTON AS.EXPELLER COFF.CAPSULE OCS ASSY</i>
	31		12000895	SCREW TSP TORX 10 3X10 PLAST.SS <i>SCREW TSP TORX 10 3X10 PLAST.SS</i>
	32		9161.378	SS HOPPER SPRING FOR BREW UNITSMART <i>SS HOPPER SPRING FOR BREW UNIT SMART</i>
	33	 ПІД ЗАМОВЛЕННЯ	9161.374.150	GRY BREWUNIT HOPPER BLOCKING PLATE SMART <i>GRY BREWUNIT HOPPER BLOCKING PLATE SMART</i>
	34	 ПІД ЗАМОВЛЕННЯ	11014199	BLK BREW UNIT FRONT PLATE V3 S/SCR.LAV. <i>BLK BREW UNIT FRONT PLATE V3 S/SCR.LAV.</i>
	35	 ПІД ЗАМОВЛЕННЯ	U023.011	SCREW TCEI M4,0X10 UNI 5931 SSA <i>SCREW TCEI M4,0X10 UNI 5931 SS A</i>
	36	 ПІД ЗАМОВЛЕННЯ	12000897	SCREW TCB TORX 10 3,5X20 PLAST.SS <i>SCREW TCB TORX 10 3,5X20 PLAST.SS</i>
	37		11031702	РОБОЧА ГРУПА V4 BLK SAECO ATLANTE, CRISTALLO <i>COFFEE GROUP V4 ATLANTE CAPS BLK</i>
	37	 ПІД ЗАМОВЛЕННЯ	11032374	BLACK BREW UNIT V2 CAP CA <i>BLACK BREW UNIT V2 ATLANTE CAPS CA</i>
	37	 ПІД ЗАМОВЛЕННЯ	11034353	BREW UNIT CAPS CO <i>BREW UNIT CAPS CO</i>
	39	 ПІД ЗАМОВЛЕННЯ	1040.028.050	STD TOOTHED CONNECT. F3/8X09 <i>STD TOOTHED CONNECT. F3/8X09</i>
	40	 ПІД ЗАМОВЛЕННЯ	11031829	COFF.CAPSULE FIXED CONT.V3 ATL700 ASSY. <i>COFF.CAPSULE FIXED CONT.V3 ATL700 ASSY.</i>
	40	 ПІД ЗАМОВЛЕННЯ	11034352	CAPSULE FIXED CONT. CO ASSY. <i>CAPSULE FIXED CONT. CO ASSY.</i>
	40	 ПІД ЗАМОВЛЕННЯ	11034993	CAPSULE FIXED CONT. CA ASSY. <i>ASS.CONT.FISSO CAPS CA</i>

Model Machine

MACSAE304

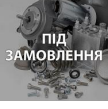
CRISTALLO 600 EVO 7GPM 1K (10004817)

	41		11032468	SILICONE TUBE 3,5X6 L=2000 MM <i>SILICONE TUBE 3.5 X 6 L=2000 MM</i>
	42	 ПІД ЗАМОВЛЕННЯ	11033574	COFFEE NOZZLES <i>COFFEE NOZZLES</i>
	43	 ПІД ЗАМОВЛЕННЯ	421941306931	STAINLESS STEEL PIERCER OUTLET COFFEE CA <i>CORPO FORATORE CA USCITA CAFFE' OCS INOX</i>
	44	 ПІД ЗАМОВЛЕННЯ	120340421	ELAST.SHAFT RETAIN.RING D=5 UNI7435 <i>ELAST.SHAFT RETAIN.RING D=5 UNI7435</i>
	45	 ПІД ЗАМОВЛЕННЯ	149203000	LOWER COFF.CAPSULE DRILLING SUPPORT OCS <i>LOWER COFF.CAPSULE DRILLING SUPPORT OCS</i>
	46	 ПІД ЗАМОВЛЕННЯ	122908721	STAINLESS STEEL PIERCER INLET WATER OCS <i>STAINLESS STEEL PIERCER INLET WATER OCS</i>
	47	 ПІД ЗАМОВЛЕННЯ	11032349	ANTI-OVERTURNING PLATE <i>ANTI-OVERTURNING PLATE</i>