

Model Machine

MACSAE113

SAECO CRISTALLO 600 ЧЁРНАЯ

MACSAE113.T.0001



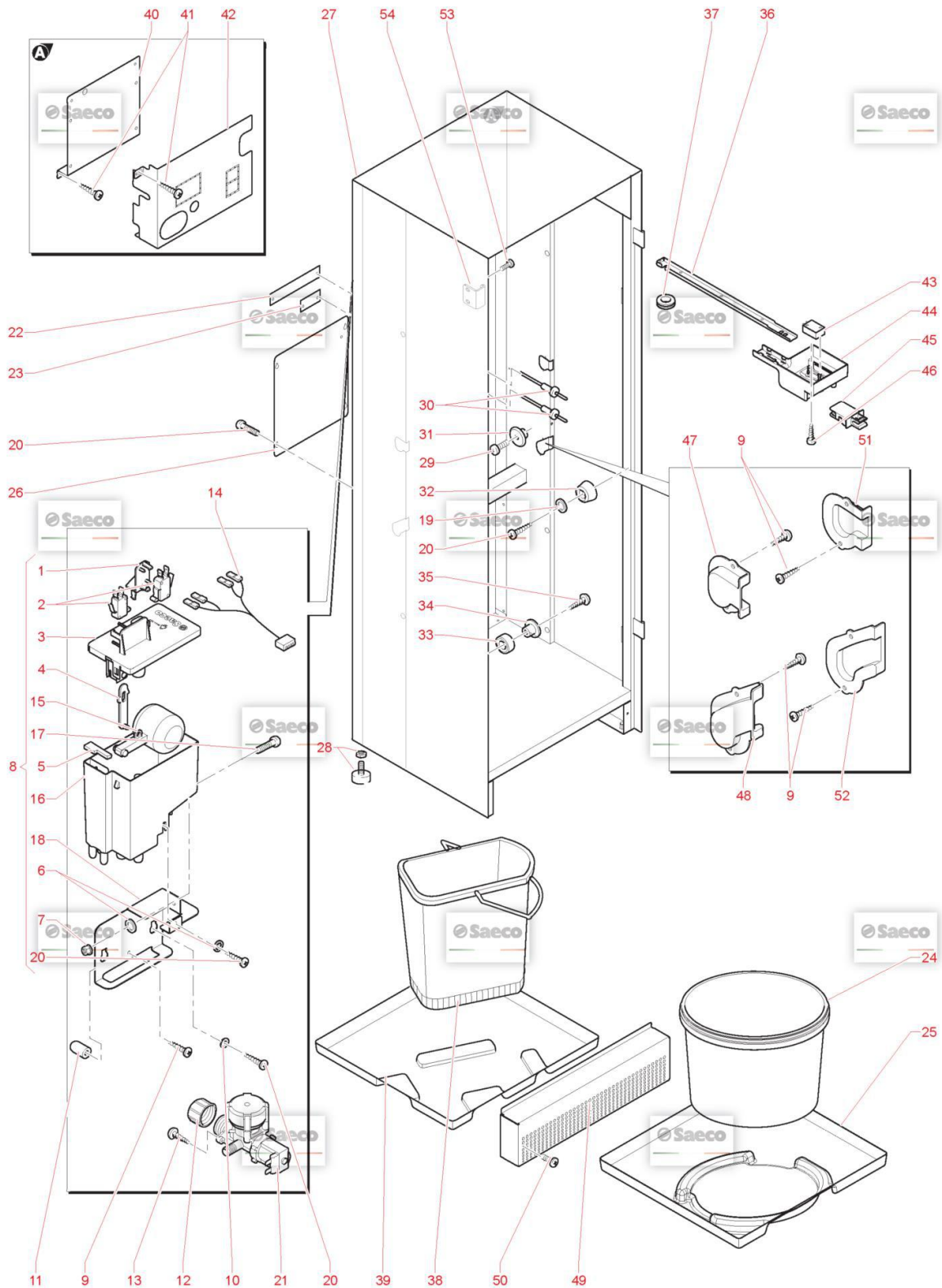





















TAVOLA NR. 1 - ARTICOLO SAECO CRISTALLO 600 ЧЁРНАЯ

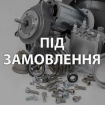

Model Machine

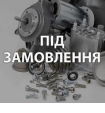
MACSAE113











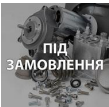

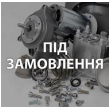













SAECO CRISTALLO 600 ЧЁРНАЯ

Web	Pos.	Foto	Item - Replace by	Description
				<i>Press - CTRL + CLICK go to item in a new window Натисніть - Ctrl + права кнопка миші щоб відкрити запчастину в новому вікні</i>
	1		9161.207.150	GREY FAUCET MICRO SUPPORT M5000 <i>SUPPORTO X MICRO RUBINETTO</i>
	2		NE05.062	MICROSWITCH + WHEEL <i>MICROINTERRUTTORE C/ROTELLA</i>
	3		9111.623	LID TANK AIR BREAK <i>COPERCHIO X SERBATOIO AIR BREAK</i>
	4		9111.621	CONNECTING ROD TANK WATER <i>CONNECTING ROD TANK WATER</i>
	5	 ПІД ЗАМОВЛЕННЯ	9111.632	RUBBER FOR AIR BREAK <i>RUBBER FOR AIR BREAK</i>
	6	 ПІД ЗАМОВЛЕННЯ	U207.009	PLAIN WASHER 5,5X15 UNI 6593 GA <i>PLAIN WASHER 5,5X15 UNI 6593 GA</i>
	7	 ПІД ЗАМОВЛЕННЯ	U324.003	NUT M5 FLANGED INDENTED BASE <i>NUT M5 FLANGED INDENTED BASE</i>
	8	 ПІД ЗАМОВЛЕННЯ	11006703	ASSEMBLY AIR BREAK CRISTALLO400 <i>ASSEMBLY AIR BREAK CRISTALLO400</i>
	9		U143.022	SCREW T.M.T. K.F.R. 3,5X9,5 ZNP <i>VITE T.M.T. K.F.R. 3,5X9,5 ZNP</i>
	10	 ПІД ЗАМОВЛЕННЯ	11011054	PIN FOR BOSS D.8 <i>PIN FOR BOSS D.8</i>
	11	 ПІД ЗАМОВЛЕННЯ	NV01.008	HOOD FOR DISPEN.COMPARTMENT SPRING <i>HOOD FOR DISPEN.COMPARTMENT SPRING</i>
	12		NV03.002	CAP 3/4 "KAPSTO 800R 3/4" <i>"CAP 3/4 "KAPSTO 800R 3/4""</i>

Model Machine

MACSAE113

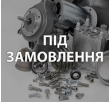









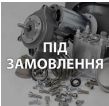

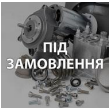













SAECO CRISTALLO 600 ЧЁРНАЯ

	13	 ПІД ЗАМОВЛЕННЯ	U110.002	SCREW AUT.TCB 3,5X13 DIN 7981F SCREW AUT.TCB 3,5X13 DIN 7981 F
	14	 ПІД ЗАМОВЛЕННЯ	1863.642	HARNESS HARNESS
	15		9111.508	FLOAT FOR AIR BREAK BOWL FLOAT FOR AIR BREAK BOWL
	16	 ПІД ЗАМОВЛЕННЯ	9111.641	TANK AIR BREAK SERBATOIO AIR BREAK C/FORO
	17		U043.015	SCREW TCBC M5,0X12 UNI 7687 GALV. SCREW TCBC M5,0X12 UNI 7687 GALV.
	18		1863.015	AIR BREAK SUPPORT AIR BREAK SUPPORT
	19		U203.001	ШАЙБА 4,3X8 UNI 1749 GA PLAIN WASHER 4,3X8 UNI 1749 GAL
	20		U110.005	SCREW AUT.TCB 3,9X9,5 DIN 7981F VITE AUT.TCB 3,9X9,5 DIN 798
	21		9121.057.00P	SAFETY ELECTROVALVE 24V DC SAFETY ELECTROVALVE 24V DC
	22	 ПІД ЗАМОВЛЕННЯ	11000371	PANEL INSPECTION LED BOARD I/O90X20 TAVOLA NR. 1 - ARTICOLO
	22	 ПІД ЗАМОВЛЕННЯ	11008157	PLATE FOR PANEL INSPECTION CADRLED 90X20 PLATE FOR PANEL INSPECTION CADR LED 90X20
	23	 ПІД ЗАМОВЛЕННЯ	11000372	PANEL INSPECTION LED BOARD I/O35X20 PANEL INSPECTION LED BOARD I/O 35X20
	23	 ПІД ЗАМОВЛЕННЯ	11008185	PLATE FOR PANEL INSPECTION CADRLED 35X20 PLATE FOR PANEL INSPECTION CADR LED 35X20
	24		12002042	BUCKET UTILPLASTIC 328X250X300BLACK BUCKET UTILPLASTIC 328X250X300 BLACK

Model Machine

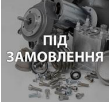
MACSAE113

















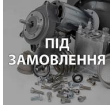



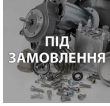



SAECO CRISTALLO 600 ЧЁРНАЯ

	25		11032654	BOTTOM TUB <i>BOTTOM TUB</i>
	26		11005970	BACK PANEL INSPECTION NEW VERSION <i>BACK PANEL INSPECTION NEW VERSION</i>
	27		11001410	COMPLETE CRISTALLO600 BOX <i>COMPLETE CRISTALLO600 BOX</i>
	27		11014246	COMPLETE CRISTALLO600 BOX BLK <i>COMPLETE CRISTALLO600 BOX BLK</i>
	27		11028013	COMPLETE CRISTALLO600 BOX BLK <i>COMPLETE CRISTALLO600 BOX BLK</i>
	28		NV01.002	FOOT D.34 H.35 WITH NUT M10 <i>PIEDINO D.34 H.35 CON DADO M</i>
	29		U043.014	SCREW TCBC M5,0X20 UNI 7687 GALV. <i>SCREW TCBC M5,0X20 UNI 7687 GALV.</i>
	30		NF11.102	RIVET 4,8X8 ALUMINUM/IRON BLACK <i>RIVET 4,8X8 ALUMINUM/IRON BLACK</i>
	31		9111.763	PIN <i>PIN</i>
	32		NV01.013	FOOT BUFFER D.20 X H10 <i>FOOT BUFFER D.20 X H10</i>
	33		11003474	FS400 DOOR WHEEL <i>FS400 DOOR WHEEL</i>
	34		11006477	FS400 DOOR PIVOT FOR WHEEL <i>FS400 DOOR PIVOT FOR WHEEL</i>
	35		12000780	SCREW TSPC M4,0X20 UNI 7688 GALV. <i>SCREW TSPC M4,0X20 UNI 7688 GALV.</i>
	36		1863.034	CHANNEL FOR DOOR CABLES <i>CHANNEL FOR DOOR CABLES</i>

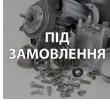
Model Machine

MACSAE113

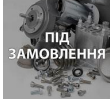









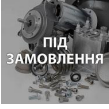

SAECO CRISTALLO 600 ЧЕРНАЯ

	37		NE16.002	GROMMET D.11X20,5XH.7 GROMMET D.11X20,5XH.7
	38		12000031	BUCKET UTILPLASTIC 18262 KOUROS 1 BLACK SECCHIO UTILPLASTIC 18262 KOUROS 1 ROSSO
	39		11000551	BOTTOM TUB VASCA DI FONDO
	40		11004621	CPU CARD SUPPORT CPU CARD SUPPORT
	41		U109.003	SCREW TCB 3,5X9,5 DIN 7981 C NICK SCREW TCB 3,5X9,5 DIN 7981 C NICK
	42		11004622	CPU CARTER CPU CARTER
	43		NE05.054	MICROSWITCH CROUZET F83161.9 MICROINTERRUTTORE CROUZET F83161.9
	44		1863.035.A20	SUPPORT FOR MICRO DOOR SUPPORTO MICRO PORTA
	45		NE05.039	BIPOLAR MICROSWITCH MICROINTERRUTTORE BIPOLARE
	45		NE05.061	MICROSWITCH CHERRY D413 .V3LD MICROINT.BIPOLARE XTD 22AZ1
	46		U116.006	SCREW AUT.PT TCB 3,5X12 WN 1441 ZNP VITE AUT.PT TCB 3,5X12 WN 1441 ZNP
	47		1863.016.A20	UPPER GUIDE LEFT PLATE UPPER GUIDE LEFT PLATE
	48		1863.017.A20	LOWER GUIDE LEFT PLATE LOWER GUIDE LEFT PLATE

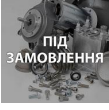
Model Machine

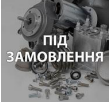
MACSAE113

SAECO CRISTALLO 600 ЧЁРНАЯ

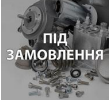

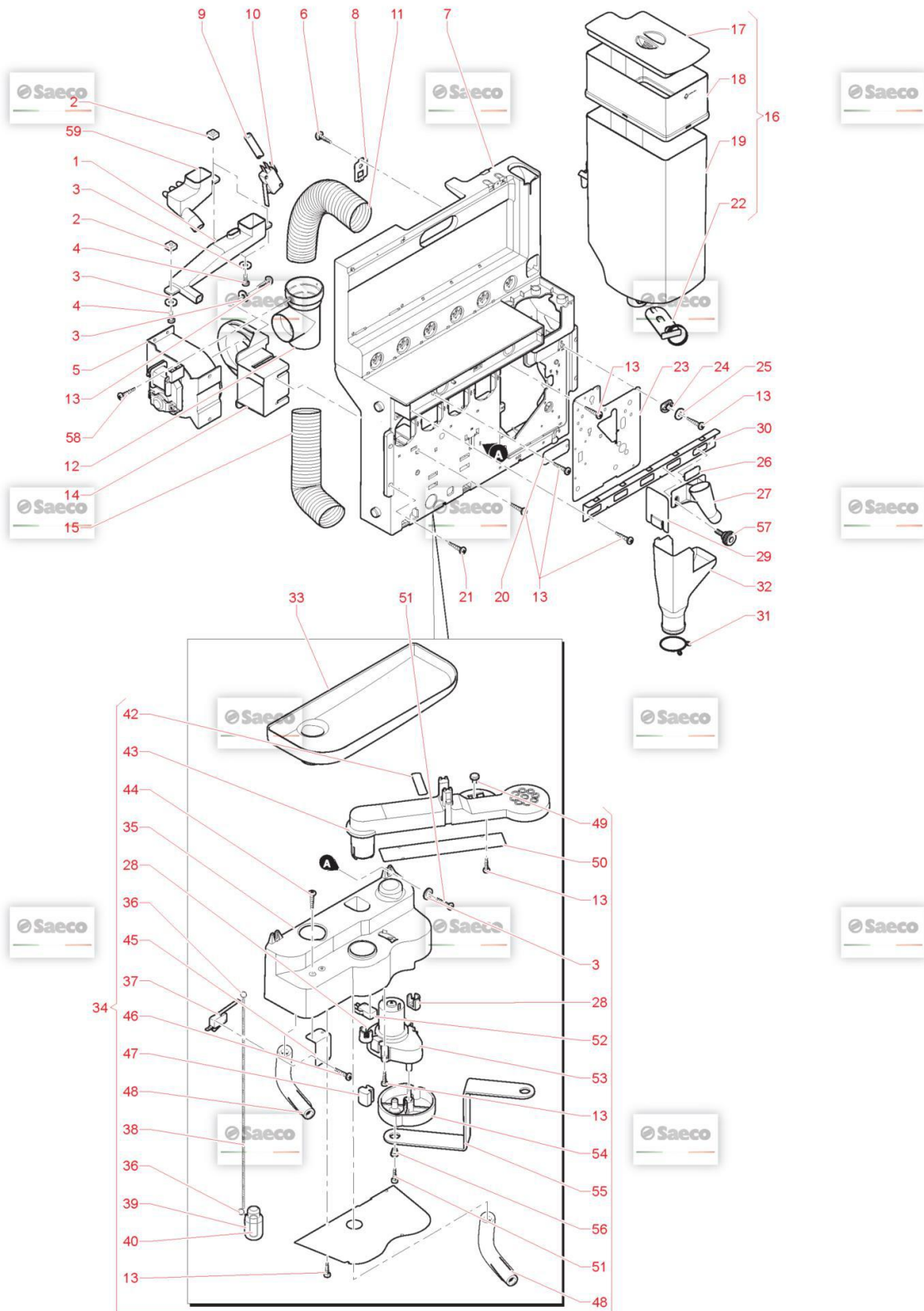























	49		11006056	BASE CRISTALLO600 BEIGE <i>BASE CRISTALLO600 BEIGE</i>
	49		11014232	BASE CRISTALLO400-600 BLACK <i>BASE CRISTALLO400-600 BLACK</i>
	50		12002052	ZN-B TCB SCREW M4X16 <i>ZN-B TCB SCREW M4X16</i>
	51		1863.018.A20	UPPER GUIDE RIGHT PLATE <i>UPPER GUIDE RIGHT PLATE</i>
	52		1863.019.A20	LOWER GUIDE RIGHT PLATE <i>LOWER GUIDE RIGHT PLATE</i>
	53		129824002	TCB SCREW M4X10 UNI 7687 ZNP <i>VITE TCB M4X10 UNI 7687 ZNP</i>
	54		11027979	ROD LOCK HOOKUP SEAGA <i>AGGANCIO ASTA X SERRATURA A 3 PUNTI</i>



Model Machine

MACSAE113

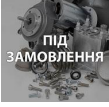











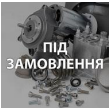













SAECO CRISTALLO 600 ЧЁРНАЯ

Web	Pos.	Foto	Item - Replace by	Description
				<i>Press - CTRL + CLICK go to item in a new window Натисніть - Ctrl + права кнопка миші щоб відкрити запчастину в новому вікні</i>
	1		9111.720.050	UNLOADING COLLECTOR COLLETORE SCARICHI
	2		U315.001	NUT SQUARE M4 UNI 5596 GALV. NUT SQUARE M4 UNI 5596 GALV.
	3		U207.002	PLAIN WASHER 4,3X9 UNI 6592 GAL ROSETTA PIANA 4,3X9 UNI 6592 ZNP
	4		129825002	TCB SCREW M4X20 UNI 7687 ZNP TCB SCREW M4X20 UNI 7687 ZNP
	5		11003905	ВЕНТИЛЯТОР 120 VL CENTRIFUGAL FAN 120V UL
	5		9121.198.00A	ВЕНТИЛЯТОР ВИТЯЖКИ 07 120X100X100 SAECO 9121.198.00A VENTILATORE CENTRIFUGO CAP 07
	6		U110.003	SCREW AUT.TCB 3,5X9,5 DIN 7981F VITE AUT.TCB 3,5X9,5 DIN 798
	7		9111.708.A20	MAIN PLATE PIASTRA PRINCIPALE
	8		9111.766	CONNECTING PLATE CONNECTING PLATE
	9		1883.004	SHEATH SHEATH
	10		NE05.018	MICROSWITCH MICROINTERRUTTORE SAECO XCG5-81-P5
	11		0862.014	ASPIRATOR TUBE L=290 ASPIRATOR TUBE L=290
	12		9111.640.060	TUBE CONNECTOR TUBE CONNECTOR

Model Machine

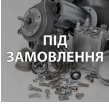
MACSAE113

















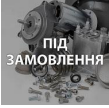





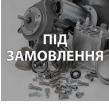

SAECO CRISTALLO 600 ЧЁРНАЯ

	13		129670202	TCB PANELVIT SCREW 3,5X16 TESTA D=8 ZNP <i>TCB PANELVIT SCREW 3,5X16 TESTA D=8 ZNP</i>
	14		9111.732.A20	SUPPORT <i>SUPPORT</i>
	15		0862.145	SPIRAL TUBE L.210MM <i>SPIRAL TUBE L.210MM</i>
	16		11006485	COFFEE TANK ASSEMBLY WITH EXTENSION <i>ASS.CONTENTITORE CAFFE CON PROLUNGA</i>
	17		9111.728	COVER FOR COFFEE CONTAINER <i>COPERCHIO CONTENITORE CAFFE'</i>
	18		11001581	EXTENSION TANK COFFEE <i>EXTENSION TANK COFFEE</i>
	19		9111.724	CONTAINER FOR COFFEE BEAN <i>CONTENTITORE CAFFE' IN GRANI</i>
	20		11000793	MIXER ASPIRATION PLATE <i>MIXER ASPIRATION PLATE</i>
	21		U023.009	SCREW TCEI M5,0X30 UNI 5931 8.8 B <i>SCREW TCEI M5,0X30 UNI 5931 8.8 B</i>
	22		11010736	ASS.GUILLOTINE COFFEE (1813.027) <i>ASS.GUILLOTINE COFFEE</i>
	23		9111.711	INOX. PLATE <i>INOX. PLATE</i>
	24		9111.717.270	KNOB FIXING PLATE <i>KNOB FIXING PLATE</i>
	25		U207.001	PLAIN WASHER 5,3X10 UNI 6592 GAL <i>ROSETTA PIANA 5,3X10 UNI 6</i>
	26		9111.481.060	COLUMN CAP <i>COLUMN CAP</i>

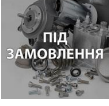
Model Machine

MACSAE113















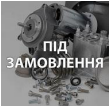











SAECO CRISTALLO 600 ЧЁРНАЯ

	27		11011651	SOLUBLECONVEYOR TTT <i>SOLUBLECONVEYOR TTT</i>
	28		11033193	SPACER MOTOR ARM <i>SPACER MOTOR ARM</i>
	29		11002131	CARTER FOR MIXER TANK <i>CARTER X VASCA MIXER</i>
	30		11011713	CRISTALLO400 TTT CANISTER'L FIXING PLATE <i>CRISTALLO400 TTT CANISTER'L FIXING PLATE</i>
	30		9111.712	INOX. PLATE FOR MIXERS <i>INOX. PLATE FOR MIXERS</i>
	31		0862.112	GROUNDS SACK RING 8P <i>КОЛЬЦО ANELLO SACCO FONDI 8P</i>
	32		0862.111.050	GROUNDS DUCT <i>CONDOTTO X FONDI</i>
	33		9111.714.A20	TANK <i>TANK</i>
	34		11028763	ETL ASSEMBLED NOZZLES ARM <i>ETL ASSEMBLED NOZZLES ARM</i>
	34		11033202	NOZZLE ARM <i>NOZZLE ARM</i>
	34		9110.148	NOZZLE ARM <i>NOZZLE ARM</i>
	35		11033186	SUPPORT NOZZLE ARM <i>SUPPORT NOZZLE ARM</i>
	35		9111.709.A20	SUPPORT NOZZLE ARM <i>SUPPORT NOZZLE ARM</i>

Model Machine

























MACSAE113

SAECO CRISTALLO 600 ЧЁРНАЯ

	36		9111.148	ELASTIC RING FOR FLOAT <i>ANELLO ELASTICO X GALLEGGIANTE</i>
	37		NE05.041	MICROSWITCH <i>MICROINTERRUTTORE</i>
	38	 ПІД ЗАМОВЛЕННЯ	9111.775	CHAIN <i>CHAIN</i>
	39	 ПІД ЗАМОВЛЕННЯ	9111.130	FLOAT FOR DISCHARGE LEVEL <i>FLOAT FOR DISCHARGE LEVEL</i>
	40		9111.147	COUNTERWEIGHT FOR FLOAT <i>CONTRAPPESO X GALLEGGIANTE</i>
	41		9111.722	PLATE <i>PIASTRA SUPPORTO BRACCIO</i>
	42		140321560	O-RING 3187 NBR <i>OR 3187 IN NBR</i>
	43		9111.710.A20	NOZZLE ARM <i>BRACCIO GIREVOLE</i>
	44	 ПІД ЗАМОВЛЕННЯ	129512903	SCREW TCB PH-AB 2,9X13 UNI 6954 NI <i>SCREW TCB PH-AB 2,9X13 UNI 6954 NI</i>
	45	 ПІД ЗАМОВЛЕННЯ	9111.719	PLATE <i>PLATE</i>
	46		U109.003	SCREW TCB 3,5X9,5 DIN 7981 C NICK <i>SCREW TCB 3,5X9,5 DIN 7981 C NICK</i>
	47		0875.150	RUBBER FOR DISPENSING COMP. <i>RUBBER FOR DISPENSING COMP.</i>
	48		11001454	PVC TUBE 16X22 L.350 MM <i>TUBO PVC 16X22 L.180MM</i>
	49		NV01.009	RUBBER BUFFER <i>GOMMINO PARACOLPI</i>

Model Machine

MACSAE113 SAECO CRISTALLO 600 ЧЁРНАЯ

	50		9111.723	PLATE <i>PIASTRA X BRACCIO</i>
	51		U116.002	SCREW AUT.PT TCB 3,5X16 WN 1441 <i>SCREW AUT.PT TCB 3,5X16 WN 1441</i>
	52		NE05.010	MICROSWITCH <i>MICROINTERRUTTORE</i>
	53		11025284	MOTORIDUTTORE FIBER 37RPM <i>MOTORIDUTTORE FIBER 37RPM</i>
	53		11033191	GEARMOTOR MECHTEX 25 RPM <i>MOTORIDUTTORE MECHTEX 25 RPM</i>
	53		9121.107.00P	STIRRER RATIONOMOTOR FIBER <i>MOTORIDUTTORE PALETTE FIBER</i>
	54		9111.716.A20	CAM ARM <i>CAMMA BRACCIO</i>
	55		9111.715	CONNECTING ROD ARM <i>BIELLA BRACCIO</i>
	56		9111.204	BUSH FOR SPRING COMPENSATE STIRRER <i>BOCCOLA X MOLLA BILANCERE PALETTE</i>
	57		12002031	KNOB D.18 M5X15 <i>KNOB D.18 M5X15</i>
	58		U109.005	SCREW AUT.TCB 3,5X16 DIN 7981C <i>VITE AUT.TCB 3,5X16 DIN 798</i>
	59		11030483	SYPHON <i>SIFONE FORATO</i>

Model Machine

MACSAE113

SAECO CRISTALLO 600 ЧЁРНАЯ

MACSAE113.T.0003

TAVOLA NR. 3 - ARTICOLO SAECO CRISTALLO 600 ЧЁРНАЯ

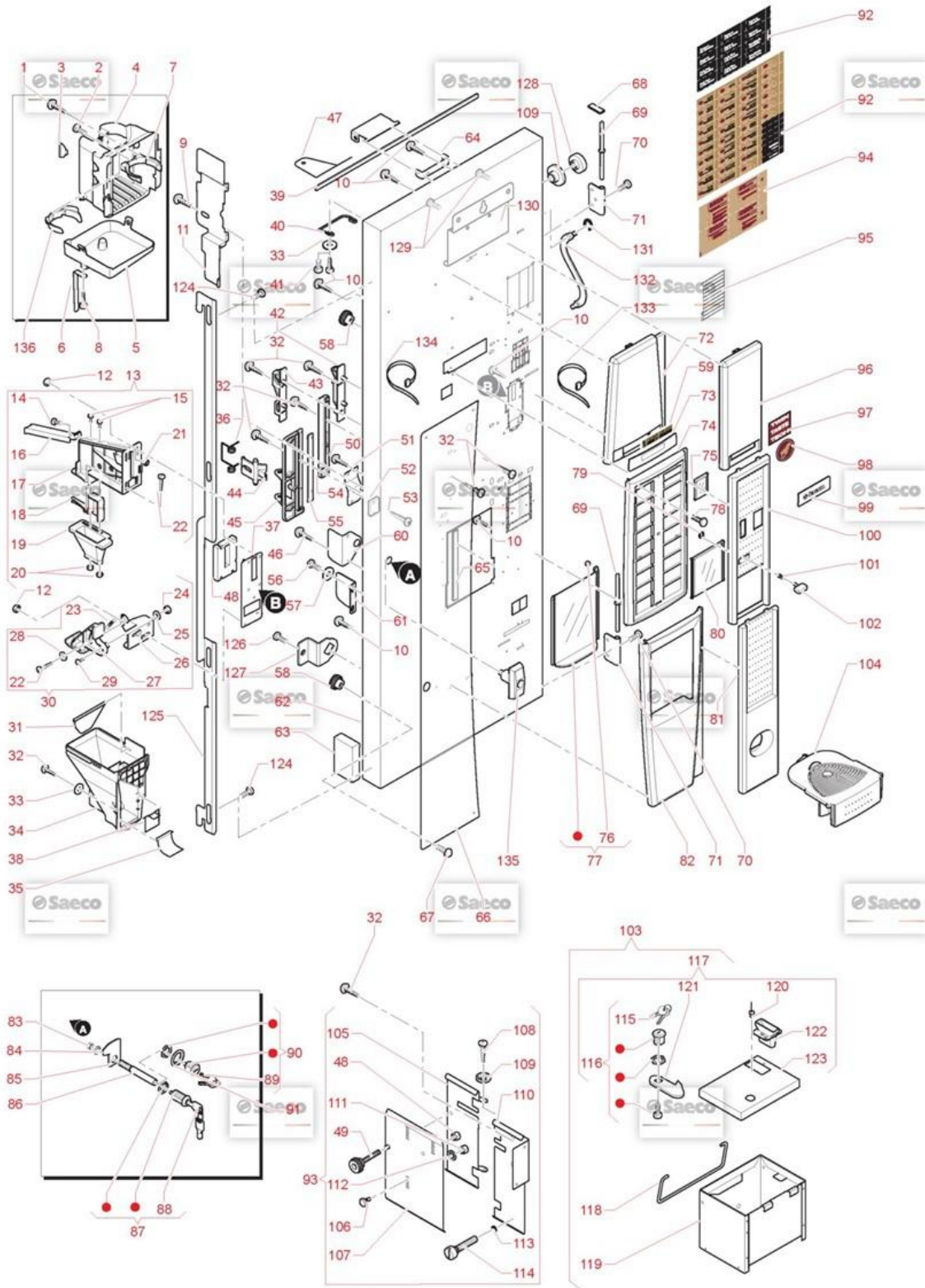

Model Machine

MACSAE113

SAECO CRISTALLO 600 ЧЁРНАЯ

Web Pos. Foto Item - Replace by Description



Press - CTRL + CLICK go to item in a new window

Натисніть - Ctrl + права кнопка миші щоб відкрити запчастину в новому вікні



1



U109.022

SCREW AUT.TCB 4,2X13 DIN 7981C
SCREW AUT.TCB 4,2X13 DIN 7981 C



2



U019.005

STEI SCREW M5,0X10 UNI 5923 GALV.
VITE STEI M5,0X10 UNI 5923 Z



3



1863.013

LENS FOR COMPARTMENT DISPENSER
LENTE X VANO EROGAZIONE



4

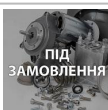

11027365

COMPARTMENT DISPENSER MILLED
COMPARTMENT DISPENSER MILLED



4

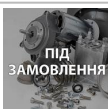

1863.012.050

COMPARTMENT DISPENSER
VANO EROGAZIONE



5



1863.023.050

WATER DRIP TRAY
VASCA X VANO EROGAZIONE



6



1863.024

STIRRUP FOR COMPARTMENT DISPENSER
STAFFA X VANO EROGATORE



7



9111.368.050

VARIABLE CUP SUPPORT BLACK
SUPPORTO BICCHIERE VARIABILE



8



U109.023

SCREW AUT.TCB 4,2X9,5 DIN 7981C
SCREW AUT.TCB 4,2X9,5 DIN 7981 C



9



U110.004

SCREW AUT.TCB 3,5X6,5 DIN 7981F
VITE AUT.TCB 3,5X6,5 DIN 7981 F NIK



10

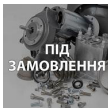

U110.003

SCREW AUT.TCB 3,5X9,5 DIN 7981F
VITE AUT.TCB 3,5X9,5 DIN 798



11



11002386

PROTECTION COVER PAYMENT SYSTEM
PROTECTION COVER PAYMENT SYSTEM



12













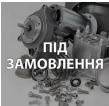















U324.003

NUT M5 FLANGED INDENTED BASE
NUT M5 FLANGED INDENTED BASE

Model Machine

MACSAE113





















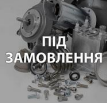



SAECO CRISTALLO 600 ЧЁРНАЯ

	13	 ПІД ЗАМОВЛЕННЯ	11011614	ASS.SCIVOLO MONETE CRISTALLO400 ASS.SCIVOLO MONETE CRISTALLO400
	14		U043.007	SCREW TCBC M3,0X8 UNI 7687 GALV. SCREW TCBC M3,0X8 UNI 7687 GALV.
	15		12002039	SCREW TCBD TORX 20 M4X12 ZN-B VITE TCBD TORX 20 M4X12 ZN-B
	16		11011663	SLIDE COVER COIN SLIDE COVER COIN
	17		11011616	COIN CHUTE COIN CHUTE
	18	 ПІД ЗАМОВЛЕННЯ	11011618	БЛОК ДЛЯ КОНВЕЄРА МОНЕТ BLOCCO X CONVOGLIATORE MONETE REGOLABILE
	19		11012131	COIN CONVEYOR ADJUSTABLE FS400/600 COIN CONVEYOR ADJUSTABLE FS400/600
	20		U302.003	GALV.NUT HEXAGONAL M4 UNI 5589ZN DADO ESAGONALE M4 UNI 5588 ZNP
	21		U302.002	NUT HEXAGONAL M3 UNI 5588 NUT HEXAGONAL M3 UNI 5588
	22		U116.005	SCREW AUT.PT TCB 3,0X8 WN 1441 VITE AUT.PT TCB 3,0X8 WN 1441 ZNP
	23		9111.397	SPRING FOR TRAY /LEVER COIN RECOVERE MOLLA X BACINELLA/LEVA RECUP
	24		123453102	GALV.SELF LOCK NUT HIGH M4 DIN982 GALV.SELF LOCK NUT HIGH M4 DIN 982
	25	 ПІД ЗАМОВЛЕННЯ	U201.005	PLAIN WASHER 4,3X12 DIN 7349 GAL PLAIN WASHER 4,3X12 DIN 7349 GAL
	26		11011619	SUPPORT LEVER COIN RECOVERY SUPPORT LEVER COIN RECOVERY

Model Machine

MACSAE113













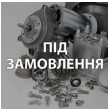



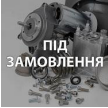

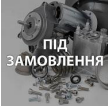







SAECO CRISTALLO 600 ЧЁРНАЯ

	27		11011660	LEVER COIN RECOVERY <i>LEVER COIN RECOVERY</i>
	28		U212.006	WASHER 3,2X11X0,5 ZNP <i>WASHER 3,2X11X0,5 ZNP</i>
	29		129825002	TCB SCREW M4X20 UNI 7687 ZNP <i>TCB SCREW M4X20 UNI 7687 ZNP</i>
	30		11011615	LEVER ASS. COIN RECOVERY <i>LEVER ASS. COIN RECOVERY</i>
	31		11011662	ADJUSTABLE PLATE <i>ADJUSTABLE PLATE</i>
	32		U110.002	SCREW AUT.TCB 3,5X13 DIN 7981F <i>SCREW AUT.TCB 3,5X13 DIN 7981 F</i>
	33		U207.002	PLAIN WASHER 4,3X9 UNI 6592 GAL <i>ROSETTA PIANA 4,3X9 UNI 6592 ZNP</i>
	34		11011661	DUCT COIN RECOVERY <i>DUCT COIN RECOVERY</i>
	35		9111.357.050	COIN CHUTE BOTTOM BLACK <i>FONDO CONDOTTO MONETE NERO</i>
	36		9111.373	SPRING FOR DISP. COMP. RETAINING <i>MOLLA X FERMO VANO EROGAZ.</i>
	37		11012569	ASS.PIASTRA MONT.CANALE MONETEF400/600 <i>ASS.PIASTRA MONT.CANALE MONETE FS400/600</i>
	37		11021706	BLANK PROTECTION COIN CHANNELRU/UA <i>BLANK PROTECTION COIN CHANNEL RU/UA</i>
	38		11001739	COIN CHUTE DOOR RED <i>PORTELLO CONDOTTO MONETE ROSSO</i>

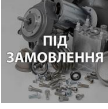
Model Machine

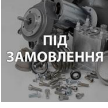
MACSAE113

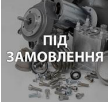









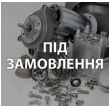

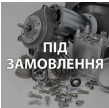













SAECO CRISTALLO 600 ЧЁРНАЯ

	38		11006845	DOOR CONDUCTING COINS GREY <i>DOOR CONDUCTING COINS GREY</i>
	39		1863.073	DOOR SEAL FS400 <i>DOOR SEAL FS400</i>
	40		11002095	SPRING FOR CHASSIS COVER'S SWITCH <i>MOLLA X MICRO COPERCHIO CARCASSA</i>
	40		11007640	SPRING FOR UPPER DOOR MICROSWITCH <i>SPRING FOR UPPER DOOR MICROSWITCH</i>
	41		U043.006	SCREW TCBC M4,0X14 UNI 7687 GALV. <i>SCREW TCBC M4,0X14 UNI 7687 GALV.</i>
	42		1863.033.A20	CUP DISTR. SUPPORT <i>SUPPORTO DISTRIBUTORE BICCH.DX</i>
	43		1863.032.A20	CUP DISTR. SUPPORT <i>SUPPORTO DISTRIBUTORE BICCH.SX</i>
	44		9111.372.050	DISP. COMPARTM. LOCKING LEVERBLAC <i>LEVA FERMO VANO EROGAZIONE NERO</i>
	45		9111.371.050	RIGHT SUPPORT DISP. COMP. BLACK <i>SUPPORTO DX VANO EROGAZ.NERO</i>
	46		U109.003	SCREW TCB 3,5X9,5 DIN 7981 C NICK <i>SCREW TCB 3,5X9,5 DIN 7981 C NICK</i>
	47		1863.079	BASKET STOP PLATE <i>BASKET STOP PLATE</i>
	48		11029543	SPACER <i>SPACER</i>
	49		12002033	KNOB D.18 M5X25 <i>KNOB D.18 M5X25</i>
	50		129512503	SCREW TCB 2,9X9,5 DIN 7981 NICK <i>SCREW TCB 2,9X9,5 DIN 7981 NICK</i>

Model Machine

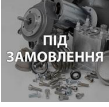
MACSAE113























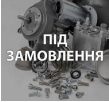

SAECO CRISTALLO 600 ЧЁРНАЯ

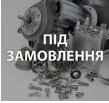
	51		1863.077	BRACKET SUPPORT REED <i>BRACKET SUPPORT REED</i>
	52		1863.649	REED FOR DOOR <i>REED FOR DOOR</i>
	53		U110.011	SCREW AUT.TCB 2,9X9,5 DIN 7981F <i>SCREW AUT.TCB 2,9X9,5 DIN 7981 F</i>
	54		1863.058	LEFT SUPPORT DISP.COMP. BLACK <i>SUPPORTO SX VANO EROGAZIONE</i>
	55		9111.774	SPACER FOR SUPPORT <i>DISTANZIALE X SUPPORTO VANO BICCH.</i>
	56		U043.015	SCREW TCBC M5,0X12 UNI 7687 GALV. <i>SCREW TCBC M5,0X12 UNI 7687 GALV.</i>
	57		U207.001	PLAIN WASHER 5,3X10 UNI 6592 GAL <i>ROSETTA PIANA 5,3X10 UNI 6</i>
	58		12002034	KNOB WITH BUSH M5 <i>KNOB WITH BUSH M5</i>
	59		15004049	ADHESIVE GRAN GUSTO <i>ADHESIVE GRAN GUSTO</i>
	60		1863.059	BRACKET FOR LOCK <i>BRACKET FOR LOCK</i>
	61		11003448	MOVABLE PLATE FOR FS400 DOOR <i>MOVABLE PLATE FOR FS400 DOOR</i>
	62		11001413	ANTERIOR COMPLETE DOOR <i>ANTERIOR COMPLETE DOOR</i>
	62		11014244	ANTERIOR COMPLETE DOOR CRISTALLO600 <i>ANTERIOR COMPLETE DOOR CRISTALLO600</i>
	62		11027978	ANTERIOR COMPLETE DOOR CRIST600 ETL <i>ANTERIOR COMPLETE DOOR CRIST600 ETL</i>

Model Machine

MACSAE113





























SAECO CRISTALLO 600 ЧЁРНАЯ

	63		11000390	OUTDISTANCE FOR FS400 DOOR <i>OUTDISTANCE FOR FS400 DOOR</i>
	64		0894.185	BASKET STOP BRACKET <i>BASKET STOP BRACKET</i>
	65		11000399	PROFILE GES26F-A-C0 L=148 MM <i>PROFILE GES26F-A-C0 L=148 MM</i>
	66		11014279	CRISTALLO400/600 DIA <i>CRISTALLO400/600 DIA</i>
	66		11028033	CRISTALLO400/600 DIA ETL <i>CRISTALLO400/600 DIA ETL</i>
	66		11030994	CRISTALLO600 C.B. DIA <i>CRISTALLO600 C.B. DIA</i>
	67		12001436	SCREW FOR BLACK SLIDE <i>SCREW FOR BLACK SLIDE</i>
	68		11003787	PROFILE GES62F-A-C0 L=20 MM <i>PROFILE GES62F-A-C0 L=20 MM</i>
	69		1863.043	HINGE <i>HINGE</i>
	70		U044.013	SCREW TSPC M4,0X12 UNI 7688 GALV. <i>VITE TSPC M4,0X12 UNI 7688 ZNP</i>
	71		11001936	FS400 MET.BEIGE HINGE <i>FS400 MET.BEIGE HINGE</i>
	71		11014249	FS400 BLK HINGE <i>FS400 BLK HINGE</i>
	72		11003414	RED PEARLY DISPLAY PANEL <i>PANNELLO DISPLAY ROSSO PERLATO</i>

Model Machine

MACSAE113























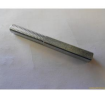



SAECO CRISTALLO 600 ЧЁРНАЯ

	72		11014269	FS400 DISPLAY PANEL BLACK <i>FS400 DISPLAY PANEL BLACK</i>
	73		1863.074	DISPLAY GLASS <i>VETRINO DISPLAY</i>
	74		11003413	RED PEARLY KEYBOARD PANEL <i>PANNELLO TASTIERA ROSSO PERLATO</i>
	74		11014291	FS400 KEYBOARD PANEL <i>FS400 KEYBOARD PANEL</i>
	75		1863.065	ASS.COIN BOX <i>VETRINO INTRODUZIONE MONETE</i>
	76		9991.093	MAGNET D=9,5 X H=1,5 <i>MAGNETE D.9,5 X 1,5</i>
	77		11032646	CUP STATION'S DOOR <i>CUP STATION S DOOR</i>
	78	 ПІД ЗАМОВЛЕННЯ	U005.015	SCREW TE M5,0X30 UNI 5739 GALV. <i>SCREW TE M5,0X30 UNI 5739 GALV.</i>
	79		U701.003	SNAP RING 7 UNI 7434 <i>ANELLO ELASTICO 7 UNI 7434</i>
	80	 ПІД ЗАМОВЛЕННЯ	1863.061	ASS.COVER BOX <i>VETRINO ISTRUZIONI</i>
	81		11003415	RED PEARLY PANEL RECOVERY REST <i>PANNELLO RECUPERO RESTO ROSSO PERLATO</i>
	81		11014270	BLACK PANEL RECOVERY REST <i>BLACK PANEL RECOVERY REST</i>
	82		11003412	RED PEARLY VAIN DISBURSEMENT PANEL <i>PANNELLO VANO EROGATORE ROSSO PERLATO</i>
	82		11014290	FS400 DISBURSEMENT PANEL VAIN <i>FS400 DISBURSEMENT PANEL VAIN</i>

Model Machine

MACSAE113

















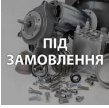





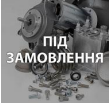

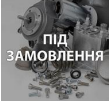
SAECO CRISTALLO 600 ЧЁРНАЯ

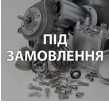
	83		U302.006	NUT HEXAGONAL M10 UNI 5588 <i>DADO ESAGONALE M10 UNI 5</i>
	84		U208.008	TOOTHED WASHER 10,5X18 UNI 3703 G <i>ROSETTA DENT. 10,5X18 UNI 3</i>
	85		11003519	PLATE FOR LOCK COMBI <i>PIASTRINA X SERRATURA COMBI</i>
	85		1863.057	LOCK LEVER <i>LOCK LEVER</i>
	86		0875.338	LOCK FOR PIN M10 <i>PERNO M10 X SERRATURA FUORI PRODUZIONE</i>
	86		11003515	PIN FOR LOCK M6 COMBI <i>PERNO X SERRATURA M6 COMBI</i>
	86		11021368	PIN FOR LOCK M6 CRISTALLO400/600 <i>PIN FOR LOCK M6 CRISTALLO400/600</i>
	87		NV02.052	TUBULAR LOCK L.31 <i>SERRATURA TUBOLARE L.31</i>
	88		1482.R02	***KEY FOR DOOR MB DA 8P <i>KEY FOR DOOR MB DA 8P</i>
	89		NV02.243	KEY RIELDA AJ306A <i>KEY RIELDA AJ306A</i>
	90		NV02.229	LOCK RIELDA MOD.512 + KEY <i>LOCK RIELDA MOD.512 + KEY</i>
	91		11014166	LOCK BUSH <i>LOCK BUSH</i>
	92		15000246	PRODUCTS LABEL'S SHEET FS400 F <i>PRODUCTS LABEL'S SHEET FS400 F</i>
	92		15000247	PRODUCTS LABEL'S SHEET FS400 I <i>PRODUCTS LABEL'S SHEET FS400 I</i>

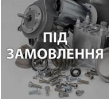
Model Machine

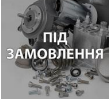
MACSAE113











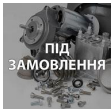

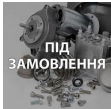

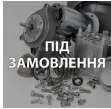

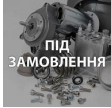

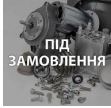

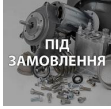

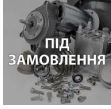

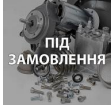

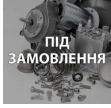
SAECO CRISTALLO 600 ЧЁРНАЯ

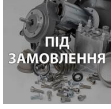
	92		15000248	PRODUCTS LABEL'S SHEET FS400 D <i>PRODUCTS LABEL'S SHEET FS400 D</i>
	92		15000249	PRODUCTS LABEL'S SHEET FS400 P <i>PRODUCTS LABEL'S SHEET FS400 P</i>
	92		15000250	PRODUCTS LABEL'S SHEET FS400 E <i>PRODUCTS LABEL'S SHEET FS400 E</i>
	92		15000251	PRODUCTS LABEL'S SHEET FS400 CH <i>PRODUCTS LABEL'S SHEET FS400 CH</i>
	92		15000252	PRODUCTS LABEL'S SHEET FS400 NL <i>PRODUCTS LABEL'S SHEET FS400 NL</i>
	92		15000253	PRODUCTS LABEL'S SHEET FS400 UK <i>PRODUCTS LABEL'S SHEET FS400 UK</i>
	92		15001893	PRODUCTS LABEL'S SHEET CRISTALLO600TTT <i>PRODUCTS LABEL'S SHEET CRISTALLO600TTT</i>
	92		15001972	PRODUCTS LABEL'S SHEET CRISTALLO BLK ITA <i>PRODUCTS LABEL'S SHEET CRISTALLO BLK ITA</i>
	92		15001973	PRODUCTS LABEL'S SHEET CRISTALLO BLK FRA <i>PRODUCTS LABEL'S SHEET CRISTALLO BLK FRA</i>
	92		15001974	PRODUCTS LABEL'S SHEET CRISTALLO BLK DE <i>PRODUCTS LABEL'S SHEET CRISTALLO BLK DE</i>
	92		15001975	PRODUCTS LABEL'S SHEET CRISTALLO BLK POR <i>PRODUCTS LABEL'S SHEET CRISTALLO BLK POR</i>
	92		15001976	PRODUCTS LABEL'S SHEET CRISTALLO BLK ESP <i>PRODUCTS LABEL'S SHEET CRISTALLO BLK ESP</i>
	92		15001978	PRODUCTS LABEL'S SHEET CRISTALLO BLK NL <i>PRODUCTS LABEL'S SHEET CRISTALLO BLK NL</i>

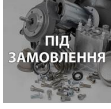
Model Machine

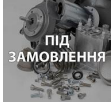
MACSAE113

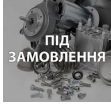









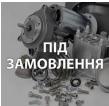

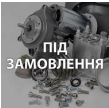













SAECO CRISTALLO 600 ЧЁРНАЯ

	92		15001979	PRODUCTS LABEL'S SHEET CRISTALLO BLK ENG <i>PRODUCTS LABEL'S SHEET CRISTALLO BLK ENG</i>
	92		15002022	PRODUCTS LABEL'S SHEET CRISTALLO600TTT <i>PRODUCTS LABEL'S SHEET CRISTALLO600TTT</i>
	92		15004032	PRODUCTS LABEL'S SHEET CRISTALLO C.B FRA <i>PRODUCTS LABEL'S SHEET CRISTALLO C.B FRA</i>
	92		15004033	PRODUCTS LABEL'S SHEET CRISTALLO C.B DE <i>PRODUCTS LABEL'S SHEET CRISTALLO C.B DE</i>
	92		15004034	PRODUCTS LABEL'S SHEET CRISTALLO C.B POR <i>PRODUCTS LABEL'S SHEET CRISTALLO C.B POR</i>
	92		15004035	PRODUCTS LABEL'S SHEET CRISTALLO C.B ESP <i>PRODUCTS LABEL'S SHEET CRISTALLO C.B ESP</i>
	92		15004036	PRODUCTS LABEL'S SHEET CRISTALLO C.B NL <i>PRODUCTS LABEL'S SHEET CRISTALLO C.B NL</i>
	92		15004044	INSTRUCTION LABEL CRISTALLO600TTT CB BLK <i>INSTRUCTION LABEL CRISTALLO600TTT CB BLK</i>
	92		15004045	PRODUCTS LABEL'S SHEET CRISTALLO C.B ITA <i>PRODUCTS LABEL'S SHEET CRISTALLO C.B ITA</i>
	92		15004046	PRODUCTS LABEL'S SHEET CRISTALLO C.B ENG <i>PRODUCTS LABEL'S SHEET CRISTALLO C.B ENG</i>
	93		1863.A13	ASS.SUPPORT COIN BOX <i>ASS.SUPPORT COIN BOX</i>
	94		15000256	INSTR./ACCEPTED COINS LABEL FS400 F <i>INSTR./ACCEPTED COINS LABEL FS400 F</i>
	94		15000257	INSTR. LABEL/ACCEPTED COINS FS400 <i>INSTR. LABEL/ACCEPTED COINS FS400</i>
	94		15000258	INSTR.LABEL/ACCEPTED COINS FS400 P <i>INSTR.LABEL/ACCEPTED COINS FS400 P</i>

Model Machine

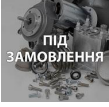
MACSAE113

















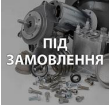





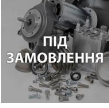

SAECO CRISTALLO 600 ЧЁРНАЯ

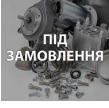
	94		15000259	INSTR./ACCEPTED COINS LABEL FS400 E <i>INSTR./ACCEPTED COINS LABEL FS400 E</i>
	94		15000260	INSTR./ACCEPTED COINS LABEL FS400 CH <i>INSTR./ACCEPTED COINS LABEL FS400 CH</i>
	94		15000261	INSTR./ACCEPTED COINS LABEL FS400 NL <i>INSTR./ACCEPTED COINS LABEL FS400 NL</i>
	94		15000262	INSTR./ACCEPTED COINS LABEL FS400 UK <i>INSTR./ACCEPTED COINS LABEL FS400 UK</i>
	94		15000263	INSTR./ACCEPTED COINS LABEL FS400 I <i>INSTR./ACCEPTED COINS LABEL FS400 I</i>
	94		15001980	INSTRUCTION LABEL CRISTALLO BLK ITA <i>INSTRUCTION LABEL CRISTALLO BLK ITA</i>
	94		15001981	INSTRUCTION LABEL CRISTALLO BLK FRA <i>INSTRUCTION LABEL CRISTALLO BLK FRA</i>
	94		15001982	INSTRUCTION LABEL CRISTALLO BLK DE <i>INSTRUCTION LABEL CRISTALLO BLK DE</i>
	94		15001983	INSTRUCTION LABEL CRISTALLO BLK POR <i>INSTRUCTION LABEL CRISTALLO BLK POR</i>
	94		15001984	INSTRUCTION LABEL CRISTALLO BLK ESP <i>INSTRUCTION LABEL CRISTALLO BLK ESP</i>
	94		15001986	INSTRUCTION LABEL CRISTALLO BLK NL <i>INSTRUCTION LABEL CRISTALLO BLK NL</i>
	94		15001987	INSTRUCTION LABEL CRISTALLO BLK ENG <i>INSTRUCTION LABEL CRISTALLO BLK ENG</i>
	94		15004037	INSTRUCTION LABEL CRISTALLO C.B ITA <i>INSTRUCTION LABEL CRISTALLO C.B ITA</i>
	94		15004038	INSTRUCTION LABEL CRISTALLO C.B FRA <i>INSTRUCTION LABEL CRISTALLO C.B FRA</i>

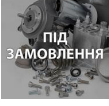
Model Machine

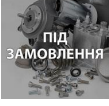
MACSAE113















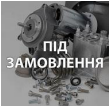











SAECO CRISTALLO 600 ЧЁРНАЯ

	94		15004039	INSTRUCTION LABEL CRISTALLO C.B DE <i>INSTRUCTION LABEL CRISTALLO C.B DE</i>
	94		15004040	INSTRUCTION LABEL CRISTALLO C.B POR <i>INSTRUCTION LABEL CRISTALLO C.B POR</i>
	94		15004041	INSTRUCTION LABEL CRISTALLO C.B ESP <i>INSTRUCTION LABEL CRISTALLO C.B ESP</i>
	94		15004042	INSTRUCTION LABEL CRISTALLO C.B NL <i>INSTRUCTION LABEL CRISTALLO C.B NL</i>
	94		15004043	INSTRUCTION LABEL CRISTALLO C.B ENG <i>INSTRUCTION LABEL CRISTALLO C.B ENG</i>
	95		0701.995	PRICE LABELS BLACK EURO <i>PRICE LABELS BLACK EURO</i>
	95		0775.989	PRICE LABELS WHITE EURO <i>PRICE LABELS WHITE EURO</i>
	96		11003417	RED PEARLY UPPER COLUMN PANEL <i>PANNELLO COLONNA SUPERIORE ROSSO PERLATO</i>
	96		11014273	BLACK FS400 SUPERIOR COLUMN PANEL <i>BLACK FS400 SUPERIOR COLUMN PANEL</i>
	97		15001210	LABEL TWIN TASTE TECH <i>LABEL TWIN TASTE TECH</i>
	97		15002044	LABEL TWIN TASTE TECH GREY <i>LABEL TWIN TASTE TECH GREY</i>
	98		15000325	ITALIAN TIME LABEL D=60MM <i>ITALIAN TIME LABEL D=60MM</i>
	99		1863.060	LOGO SAECO GLASS <i>VETRINO LOGO SAECO</i>

Model Machine

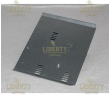
MACSAE113











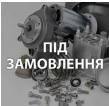





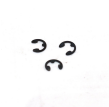









SAECO CRISTALLO 600 ЧЁРНАЯ

	10001		11003416	RED PEARLY COIN INTRODUCTION PANEL <i>PANNELLO INTROD.UZ.MONETE ROSSO PERLATO</i>
	10001		11014265	FS400 INTRODUCTION COINS PANELBLK <i>FS400 INTRODUCTION COINS PANEL BLK</i>
	10001		11014267	PANEL COIN INPUT BLACK <i>PANEL COIN INPUT BLACK</i>
	1010		9111.355	SPRING FOR CHANGE BUTTON <i>MOLLA X PULSANTE RENDIRESTO</i>
	1020		11000392	BUTTON RECOVERY COINS <i>PULSANTE RECUPERO MONETE CROMATO OPACO</i>
	1020		11001795	COIN RECOVERY BUTTON RED <i>COIN RECOVERY BUTTON RED</i>
	1020		11006846	PULSANTE RECUPERO MONETE GRY <i>PULSANTE RECUPERO MONETE GRY</i>
	1030		11021831	ASSEMBLY COIN BOX <i>ASSEMBLY COIN BOX</i>
	1040		11001836	FS400 STANDARD GRILL <i>GRIGLIA STANDARD FS400</i>
	1050		0875.365	SUP.COIN BOX <i>SUP.COIN BOX</i>
	1060		9111.614	COIN BOX ANCHORING PIN <i>COIN BOX ANCHORING PIN</i>
	1070		0875.357	ASS.FIXING PLATE COIN BOX <i>ASS.FIXING PLATE COIN BOX</i>
	1080		U110.005	SCREW AUT.TCB 3,9X9,5 DIN 7981F <i>VITE AUT.TCB 3,9X9,5 DIN 798</i>
	1090		1602.147	BUSH FOR DOOR CONNECTING ROD <i>BUSH FOR DOOR CONNECTING ROD</i>

Model Machine

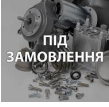
MACSAE113

















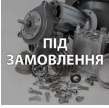





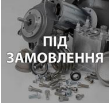

SAECO CRISTALLO 600 ЧЕРНАЯ

	1100		11032971	COIN BOX SUPPORT <i>COIN BOX SUPPORT</i>
	1110		123160302	NUT M3 HIGH UNI 5587 GALVANIZED <i>NUT M3 HIGH UNI 5587 GALVANIZED</i>
	1120		U207.003	PLAIN WASHER 3,2X7 UNI 6592 GALV. <i>PLAIN WASHER 3,2X7 UNI 6592 GALV.</i>
	1130		U701.011	STEEL SNAP RING 5 UNI 7434 <i>ANELLO ELASTICO 5 UNI 7434</i>
	1140		11004932	ADJUSTMENT PIN PLATE COIN BOX <i>ADJUSTMENT PIN PLATE COIN BOX</i>
	1150		0701.R29	KEY KA 35 <i>CHIAVE VIRO KA 35 X SERRAT.S</i>
	1150		20007333	KEY MERONI 337 <i>KEY MERONI 337</i>
	1160		12001902	LOCK MERONI 337 <i>LOCK MERONI 337</i>
	1160		20007143	KIT SPARE PART <i>KIT SPARE PART</i>
	1170		11012748	COIN BOX CASE LID ASS. NEW <i>COIN BOX CASE LID ASS. NEW</i>
	1180		0875.271	HANDLE FOR COIN CASE <i>HANDLE FOR COIN CASE</i>
	1190		11021832	MONEY BOX ASSEMBLY <i>MONEY BOX ASSEMBLY</i>
	1200		NF11.026	EXPANSION RIVET D.3,9X8 ALU. <i>RIVETTO AD ESPANSIONE D.3,9X8 ALL.</i>
	1210		11001583	LEVER FOR LOCK <i>LEVER FOR LOCK</i>

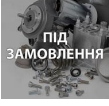
Model Machine

MACSAE113

SAECO CRISTALLO 600 ЧЁРНАЯ

	1210		11031071	LEVER FOR LOCK <i>LEVER FOR LOCK</i>
	1220		11011665	COIN BOX HOPPER <i>COIN BOX HOPPER</i>
	1230		1863.064	COVER COIN BOX <i>COVER COIN BOX</i>
	1240		U046.007	SCREW TEFZ M4,0X12 GALV. <i>SCREW TEFZ M4,0X12 GALV.</i>
	1250		11028040	ROD FOR LOCK DOOR SEAGA <i>ROD FOR LOCK DOOR SEAGA</i>
	1260		U046.001	SCREW TEFZ M5,0X16 UNI 6921 GALV. <i>SCREW TEFZ M5,0X16 UNI 6921 GALV.</i>
	1270		11028041	LEVER FOR LOCK SEAGA <i>LEVER FOR LOCK SEAGA</i>
	1280		11008644	LOCK PIN <i>LOCK PIN</i>
	1290		U046.005	SCREW TE M5,0X10 WITH WASHER <i>SCREW TE M5,0X10 WITH WASHER</i>
	1300		11028022	DISPENSER GLASSES SUPPORT D.83CRISTALLO <i>DISPENSER GLASSES SUPPORT D.83 CRISTALLO</i>
	1310		U701.001	SNAP RING 4 UNI 7434 <i>ANELLO ELASTICO 4 UNI 7434</i>
	1320		11008615	LEVER ASS. LOCK <i>LEVER ASS. LOCK</i>
	1330		144320200	SELF LOCK STRIP W=2.6 L=200 <i>SELF LOCK STRIP W=2.6 L=200</i>

Model Machine

MACSAE113

SAECO CRISTALLO 600 ЧЁРНАЯ



1340

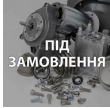

NF11.002

SELF LOCK STRIP W=2.5 L=98

SELF LOCK STRIP W=2.5 L=98



1350

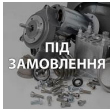

12001724

LOCK EVERGOOD WITH HANDLE A 'T'

LOCK EVERGOOD WITH HANDLE A 'T'



1360



11027722

CUP SUPPORT D.83



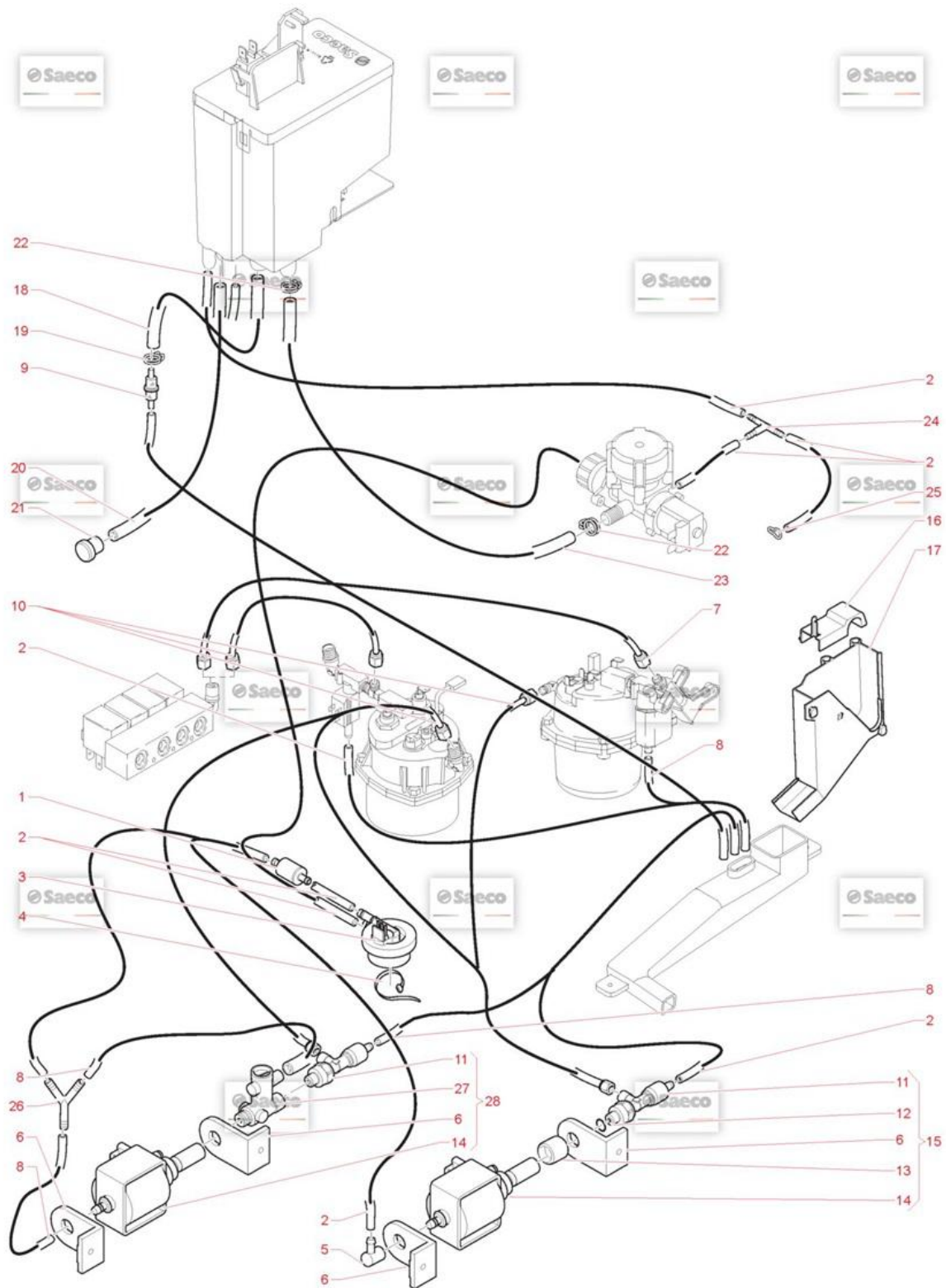









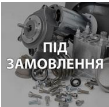













CUP SUPPORT D.83



Model Machine

MACSAE113

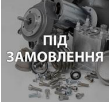









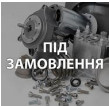















SAECO CRISTALLO 600 ЧЁРНАЯ

Web	Pos.	Foto	Item - Replace by	Description
				<i>Press - CTRL + CLICK go to item in a new window Натисніть - Ctrl + права кнопка миші щоб відкрити запчастину в новому вікні</i>
	1		11024178	WATER FILTER PHEDRA WATER FILTER PHEDRA
	2		9972.057	КОРИЧНЕВА ГУМОВА ТРУБКА 5X8 2 МЕТРИ TUBO SILICONE MARRON 5X8 L.2000 MM
	3		NV99.099	TURBINE D=1,2 ASSY. TURBINA DIGMESA FHKSC 1,2 ARNITE OC
	4		144320200	SELF LOCK STRIP W=2.6 L=200 SELF LOCK STRIP W=2.6 L=200
	5		147920150	90° INLET PUMP CONNECTOR RACCORDO A 90° IN SANTOPRENE
	6		149185850	ТРИМАЧ (ГУМОВИЙ)ПОМПИ ДЛЯ КАВОМАШИН SAECO MAGIC 4002012 (... SUPPORTO POMPA EATON MAGIC 4
	7		11025292	TEFLON TUBE 3X6 L.230 1/8"-1/8 TEFLON TUBE 3X6 L.230 1/8"-1/8
	8		9972.247	SILICONE TUBE 5X10 L.1400MM TUBO SILICON.5X10 L=2000MM 60 SHORE
	9		144650300	ФІЛЬТР ОЧИСТКИ ВОДИ ДЛЯ КАВОМАШИНИ SAECO NEW (NV99.001) (88... ASPIRATION FILTER GAUZE NET 500 (NEW)
	10		11025297	TEFLON TUBE 3X6 L.310 1/8"-1/8 TEFLON TUBE 3X6 L.310 1/8"-1/8
	11		11005590	SAFETY VALVE/NON RETURN ASS. NEW ASS.VALVOLA SICUREZZA/NON RI
	12		NM02.020	OR 2031 TERMOIL OR 2031 TERMOIL
	13		9071.098	REINFORCEMENT FOR ULKA PUMP REINFORCEMENT FOR ULKA PUMP

Model Machine

MACSAE113















SAECO CRISTALLO 600 ЧЁРНАЯ

	14		9070.034.00F	ULKA PUMP EP7 120V <i>ULKA PUMP EP7 120V</i>
	14		9070.042.00A	ULKA НАСОС (ПОМПА) EX5GW 230/240V 50HZ SD1 БЪЯНКО 15 BAR <i>ULKA PUMP EX5 SD1</i>
	14		9070.042.00N	PUMP 220V <i>ULKA PUMP EX5 SD1</i>
	14		9070.044.00F	PUMP 120V-60HZ <i>ULKA PUMP EP5 D1</i>
	15		11012024	ULKA PUMP ASS. EP7 120/60 CR600TTT UL <i>ULKA PUMP ASS. EP7 120/60 CR600TTT UL</i>
	15		9070.043.00A	ULKA PUMP+NON RETURN <i>ULKA PUMP EX5 SD1 +NON RETURN</i>
	15		9070.043.00N	PUMP+NON RETURN <i>ULKA PUMP EX5 SD1 +NON RETURN</i>
	15		9070.045.00F	PUMP 120V <i>ULKA PUMP ASS.EP5 D1 120V</i>
	16		9161.262.060	DRIP CHANNEL COVER <i>COPERTURA CANALINO RACCOGLIGOCCE</i>
	17		9111.597.050	COFFEE DISCHARGE CHANNEL SHORT <i>CANALINO SCARICO CAFFE' CORTO</i>
	18		9972.141	SILICONE TUBE 7X11 L.160MM <i>SILICONE TUBE 7X11 L.160 MM</i>
	19		NV99.072	HOSE CLAMP D. 11.6/12.3 <i>HOSE CLAMP D. 11.6/12.3</i>
	20		9972.335	SILICONE TUBE 7X11 L.135MM <i>TUBO SILICONE 7X11 L.1240 MM</i>
	21		NV03.006	CAP KAPSTO LPN 615/010 <i>TAPPO KAPSTO LPN 615/010</i>

Model Machine

MACSAE113

SAECO CRISTALLO 600 ЧЁРНАЯ

	22		NV99.050	HOSECLAMP D. 13.3/14.1 <i>HOSECLAMP D. 13.3/14.1</i>
	23	 ПІД ЗАМОВЛЕННЯ	9972.134	SILICONE TUBE 7X11 L.850MM <i>SILICONE TUBE 7X11 L.850 MM</i>
	24		NV99.004	CONNECTOR T MORONI 8026047 D=8 <i>CONNECTOR T MORONI 8026047 D=8</i>
	25		9111.141	DISCHARGE TUBE CLOSURE SPRING <i>DISCHARGE TUBE CLOSURE SPRING</i>
	26		147920800	Y CONNECTOR D=8 ART.80.26.048KA.466 <i>RACCORDO Y D=8 ART.80.26.048 KA.466</i>
	27		20007360	ОБХІДНИЙ КЛАПАН FLUID-O-TECH B7E <i>BYPASS VALVE FLUID-O-TECH B7E</i>
	28	 ПІД ЗАМОВЛЕННЯ	11032988	ASSMEBLY PUMP EX5 SD1 230V <i>ASSMEBLY PUMP EX5 SD1 230V</i>

Model Machine

MACSAE113

SAECO CRISTALLO 600 ЧЁРНАЯ

MACSAE113.T.0005



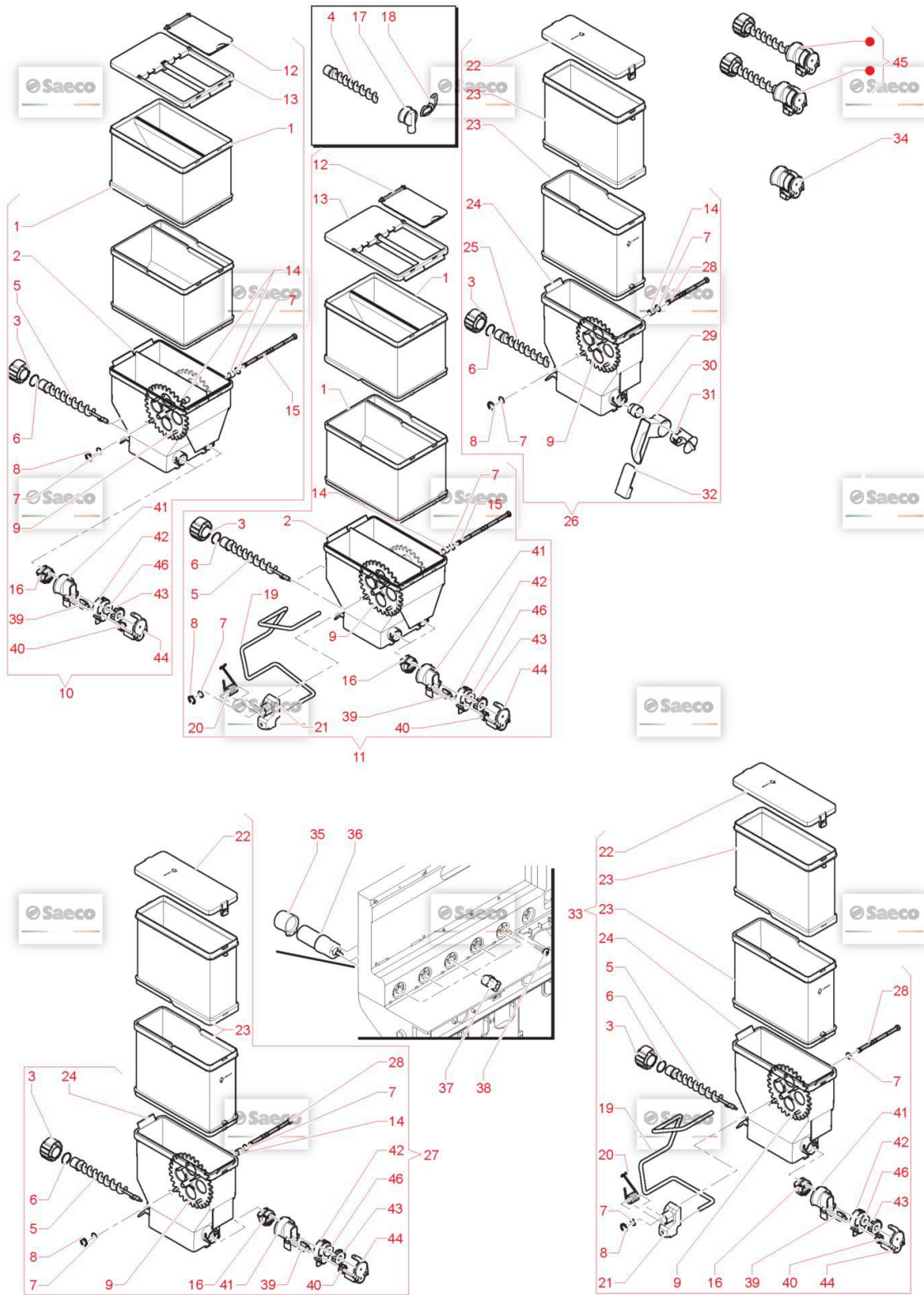























TAVOLA NR. 5 - ARTICOLO SAECO CRISTALLO 600 ЧЁРНАЯ



Model Machine

MACSAE113











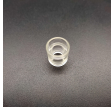















SAECO CRISTALLO 600 ЧЁРНАЯ

Web	Pos.	Foto	Item - Replace by	Description
				<i>Press - CTRL + CLICK go to item in a new window Натисніть - Ctrl + права кнопка миші щоб відкрити запчастину в новому вікні</i>
	1		9111.681	DOUBLE EXTENSION 145 <i>PROLUNGA DOPPIA 145</i>
	2		9111.680	BASE CONTAINER DOUBLE SOLUBLE <i>BASE CONTENITORE SOLUBILI DOPPIO</i>
	3		11012130	BACK BUSH REINFORCE <i>BACK BUSH REINFORCE</i>
	4		9111.701	SCROLL SCREW DOUBLE CONTAINER <i>COCLEA CONTENITORE DOPPIO</i>
	5		11005180	SCROLL SCREW FOR NEW DISPENSER APERTURE <i>COCLEA X BOCCHETTA EROGAZIONE APERTURE SCROLL SCREW FOR ...</i>
	6		NM03.013	OR 2,3X15 NBR <i>OR 2,3X15 NBR</i>
	7		NM03.022	OR ORM 0060-10 NBR <i>OR ORM 0060-10 NBR</i>
	8		U701.003	SNAP RING 7 UNI 7434 <i>ANELLO ELASTICO 7 UNI 7434</i>
	9		9111.702	WHEEL DOUBLE CONTAINER <i>RUOTA CONTENITORE DOPPIO</i>
	10		11031891	ASSEMBLED DOUBLE TANK EASY DRY2 <i>ASSEMBLED DOUBLE TANK EASY DRY 2</i>
	11		11031885	PHEDRA ASSEMBLED DOUBLE TANK <i>PHEDRA ASSEMBLED DOUBLE TANK</i>
	12		9111.683	SOLUBLE COVER <i>COPERCHIETTO SOLUBILI</i>
	13		9111.682	COVER CONTAINER DOUBLE SOLUBLE <i>COPERCHIO CONT.SOLUBILI DOPPIO</i>

Model Machine

MACSAE113













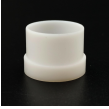











SAECO CRISTALLO 600 ЧЁРНАЯ

	14		11032945	SPACE FOR GEAR BPA FREE <i>SPACE FOR GEAR BPA FREE</i>
	15		9111.703	DOUBLE PIN FOR WHEEL <i>PERNO DOPPIA PER RUOTA</i>
	16		11028378	FRONT BUSH <i>FRONT BUSH</i>
	17		9111.629.060	APERTURE FOR SOLUBLES HOPPER <i>APERTURE FOR SOLUBLES HOPPER</i>
	18		9111.338.270	BULKHEAD FOR APERT. CLOSURE ORANGE <i>PARATIA CHIUSURA BOCCHETTA ARANCIO</i>
	19		11006124	WIRE AGITATOR UNIFIED <i>FILO AGITATORE UNIFICATO WIRE AGITATOR UNIFIED</i>
	20		9111.731	SPRING <i>MOLLA AGITATORE</i>
	21		11007155	ПЛАСТИКОВИЙ ТРИМАЧ ВЗБИВАЛКИ SAECO 9111.735 <i>AGITATOR SUPPORT</i>
	22		11001578	COVER CONTAINER SINGLE SOLUBLE <i>COPERCHIO CONTENITORE SOLUBILE SINGOLO</i>
	23		11001577	EXTENSION CONTAINER SINGLE SOLUBLE <i>PROLUNGA CONTENITORE SOLUBILE SINGOLO</i>
	24		11001576	BASE CONTAINER SINGLE SOLUBLE <i>BASE CONTENITORE SOLUBILE SINGOLO</i>
	25		11001658	SCROLL SCREW <i>COCLEA PER DEVIATORE</i>
	26		11004505	ASSEMBLY SINGLE CONTAINER W/SWITCH <i>ASS.MONTATO CONT.SINGOLO C/DEVIATORE</i>
	27		11031883	ASSEMBLY SINGLE CONTAINER <i>ASSEMBLY SINGL CONTAINER</i>

Model Machine

MACSAE113









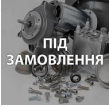

SAECO CRISTALLO 600 ЧЁРНАЯ

	28		11001580	PIN WHEEL CONTAINER SINGLE SOLUBLE <i>PERNO RUOTA DENTATA CONT.SOLUB.SINGOLO</i>
	29		11001654	BUSH CONTAINER <i>BOCCOLA CONTENITORE</i>
	30		9111.425.060	POWDER DUCT <i>CONDOTTO POLVERE ORIENTABILE</i>
	31		9111.457.060	BUSH FOR LEFT/RIGHT DUCT COSMEC <i>BOCCOLA X CONDOTTO DX-SX COSMEC</i>
	32		9111.428.060	PLUG FOR LEFT-RIGHT DUCT <i>TAPPO X CONDOTTO DX-SX</i>
	33		11031886	ASSEMBLY SINGLE CONTAINER <i>ASSEMBLY SINGLE CONTAINER</i>
	34		21002190	KIT EASY DRY 2 <i>KIT EASY DRY</i>
	35		9121.155	HOOD FOR RATIOMOTOR <i>CUFFIA X MOTORIDUTTORE</i>
	36		9121.106.00P	SUGAR RATIOMOTOR 24V DC <i>MOTORIDUTTORE ZUCCHERO 24V D.C.</i>
	37		9111.131	COUPLING FOR SOLUBLES MOTOR <i>GIUNTO X MOTORE SOLUBILI</i>
	38		U116.005	SCREW AUT.PT TCB 3,0X8 WN 1441 <i>VITE AUT.PT TCB 3,0X8 WN 1441 ZNP</i>
	39		11031679	DISPENSER FAN EASY DRY <i>DISPENSER FAN EASY DRY</i>
	40		11005182	WHEEL Z=9 <i>WHEEL Z=9</i>

Model Machine

MACSAE113

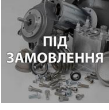
SAECO CRISTALLO 600 ЧЁРНАЯ

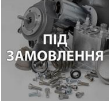
	41		11031678	EASY DRY DISPENSER APERTURE <i>EASY DRY DISPENSER APERTURE</i>
	42		11031691	CARTER FOR GEAR EASY DRY <i>CARTER FOR GEAR EASY DRY</i>
	43		11031690	WHEEL Z=18 EASY DRY <i>WHEEL Z=18 EASY DRY</i>
	44		11005168	LID CARTER GEAR <i>LID CARTER GEAR</i>
	45		21001290	KIT NEW POWDER DISPENSING SYSTEM <i>KIT NEW POWDER DISPENSING SYSTEM</i>
	46		11031692	FELT RING DE=47,4 DI=41,4H=4 <i>FELT RING DE=47,4 DI=41,4H=4</i>

Model Machine

MACSAE113

SAECO CRISTALLO 600 ЧЁРНАЯ

MACSAE113.T.0006



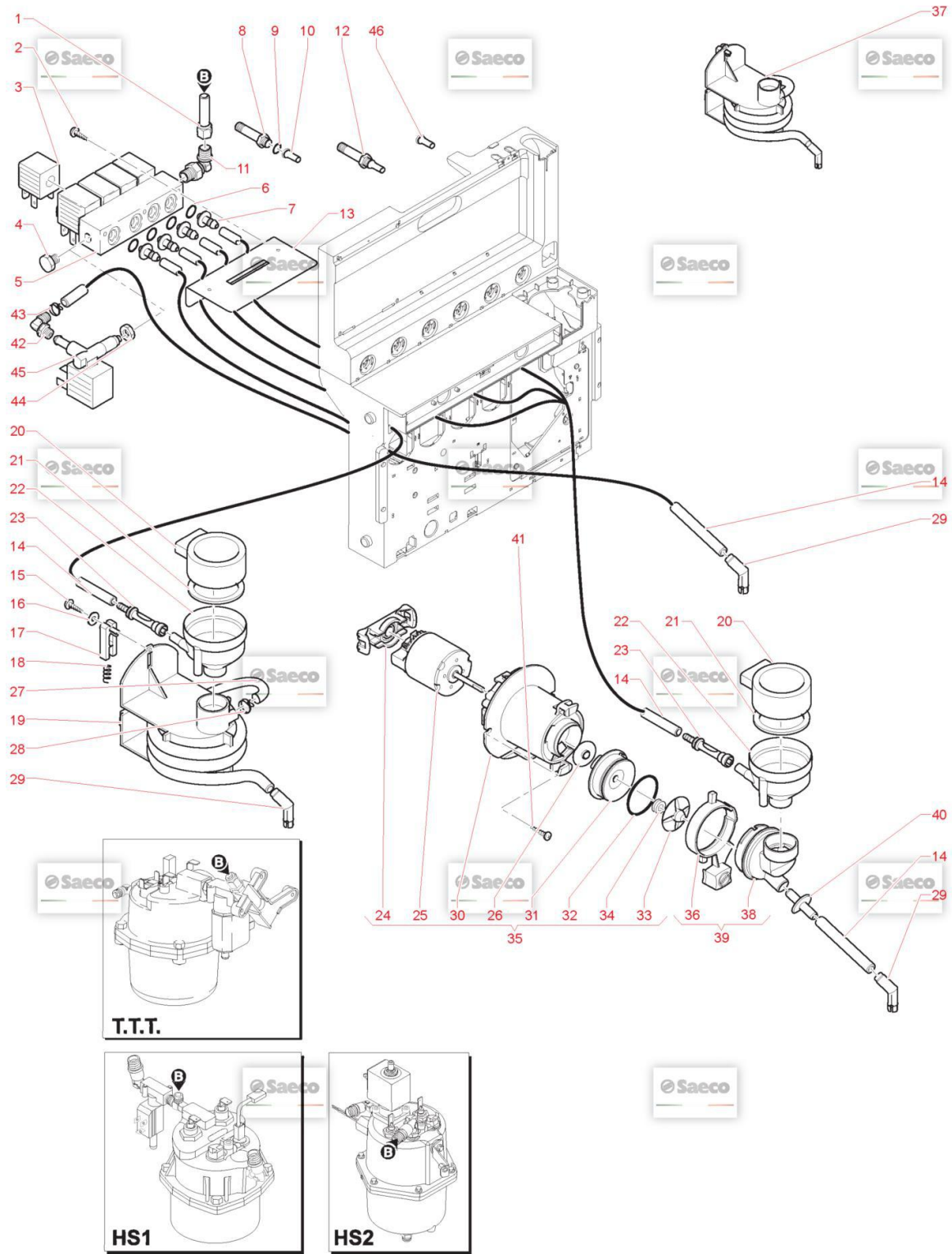









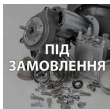

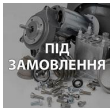









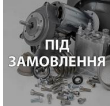

TAVOLA NR. 6 - ARTICOLO SAECO CRISTALLO 600 ЧЁРНАЯ

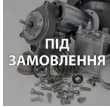

Model Machine

MACSAE113





























SAECO CRISTALLO 600 ЧЁРНАЯ

Web	Pos.	Foto	Item - Replace by	Description
				<i>Press - CTRL + CLICK go to item in a new window Натисніть - Ctrl + права кнопка миші щоб відкрити запчастину в новому вікні</i>
	1		11025292	TEFLON TUBE 3X6 L.230 1/8"-1/8 TEFLON TUBE 3X6 L.230 1/8"-1/8
	1		11025297	TEFLON TUBE 3X6 L.310 1/8"-1/8 TEFLON TUBE 3X6 L.310 1/8"-1/8
	2		129516803	SCREW TCB3,5X19 DIN 7981 NICK SCREW TCB3,5X19 DIN 7981 NICK
	3		0862.R07	SOLENOID FOR MM VALVE 3 WAY 24V DC SOLENOID FOR MM VALVE 3 WAY 24V DC
	3		20005373	SOLENOID X HS1 11023762 SOLENOID X OLAB 24V DC 6000BH/BODN
	4		12001169	BRASS CAP 1/8 GAS CONICAL TEA BRASS CAP 1/8 GAS CONICAL TEA
	5		11009225	BLOCK 4 ELECTROVALVE DC OLAB BLOCK 4 ELECTROVALVE DC OLAB
	5		11011470	BLOCK 4 ELECTROVALVE DC OLAB TEA BLOCK 4 ELECTROVALVE DC OLAB TEA
	5		9121.156.00P	4 ELECTROVALVE DC BLOCK 4 ELECTROVALVE DC BLOCK
	6		NM01.004	OR 2025 SILICONE OR 2025 SILICONE
	7		11011453	RUBBER HOLDER CONNECTOR TEA RUBBER HOLDER CONNECTOR TEA
	8		0875.R09	TUBE CANOTTO
	9		0875.R10	OR X TUBE OR X CANOTTO

Model Machine

MACSAE113



























SAECO CRISTALLO 600 ЧЁРНАЯ

	10		0875.R11	NUCLEUS FOR SPRING <i>NUCLEO CON MOLLA</i>
	11		11025082	1/8"G M/CONICAL ORIENT. NUT/OGV <i>1/8G M/CONICAL ORIENT. NUT/OGV</i>
	11		12001181	BICONICAL CONNECT. L M 1/8X06TEA <i>BICONICAL CONNECT. L M 1/8X06 TEA</i>
	12		20005374	ASS.NUCLEO FIS+MOB.X 11009225 <i>ASS.NUCLEUS 6000BH/BODN X 11009225</i>
	13		9111.713	PLATE <i>PIASTRA ELETTROVALVOLE</i>
	14		9972.057	КОРИЧНЕВА ГУМОВА ТРУБКА 5X8 2 МЕТРИ <i>TUBO SILICONE MARRON 5X8 L.2000 MM</i>
	15		U116.005	SCREW AUT.PT TCB 3,0X8 WN 1441 <i>VITE AUT.PT TCB 3,0X8 WN 1441 ZNP</i>
	16		U207.004	PLAIN WASHER 4,3X16 UNI 6592 GAL <i>PLAIN WASHER 4,3X16 UNI 6592 GAL</i>
	17		9111.209.060	CURSOR FOR SPIRAL MIXER FIXING <i>CURSOR FOR SPIRAL MIXER FIXING</i>
	18		9111.211	SPRING FOR MIXER CURSOR <i>MOLLA X CURSORE MISCELATORE</i>
	19		9111.643.060	RAPID FIXING MIXER <i>RAPID FIXING MIXER</i>
	20		9111.010.060	LID FOR FUNNEL BROWN <i>COPERCHIO X IMBUTO MARRON</i>
	21		9111.011.060	SEAL FOR FUNNEL BROWN <i>GUARNIZIONE X IMBUTO MARRON</i>
	22		9111.009.060	FUNNEL FOR POWDERS BROWN <i>IMBUTO X POLVERI MARRON</i>

Model Machine

MACSAE113























SAECO CRISTALLO 600 ЧЁРНАЯ

	23		1863.A07	ESPRESSO NOZZLE ASS.UGELLO ESPRESSO
	24		9111.771.270	MOTOR COUPLING ORANGE RAL MOTOR COUPLING ORANGE RAL
	25		9121.248.00P	MOTOR МИКСЕРА '05 24V DC - M.B.T. COD. 912124800 SAECO 9121.248.00 MOTORE MIXER '05 24V DC - M.B.T.
	26		9111.773.060	MOTOR PROTECTION RING ANELLO PROTEZIONE MOTORE MIXER '05
	27		9972.055	ТРУБКА СИЛИКОНОВА 8X12 2 МЕТРИ SILICONE TUBE 8X12 L.2000MM
	28		NV99.072	HOSE CLAMP D. 11.6/12.3 HOSE CLAMP D. 11.6/12.3
	29		9111.349	ELBOW DISPENSING NOZZLE UGELLO EROGAZIONE GOMITO
	30		9111.769.150	MIXER FLANGE MIXER FLANGE
	31		9111.770.060	COVER MIXER FLANGE COVER MIXER FLANGE
	32		NM03.012	OR ORM 0320-25 NBR OR ORM 0320-25 NBR
	33		9111.772.060	DISK FAN VENTOLINA A DISCO MIXER '05
	34		NM05.015	ПРОКЛАДКА V-RING 405 МИКСЕРА ДЛЯ КАВОМАШИН SAECO V-RING MIXER '05
	35		9110.160.06P	ДВИГУН МИКСЕРА ДЛЯ КАВОМАШИНИ SAECO 05 24V DC SAECO 9110.1... ASS.MIXER '05 24V DC GROUP 500 SAECO

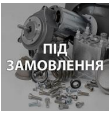
Model Machine

MACSAE113

SAECO CRISTALLO 600 ЧЁРНАЯ

	36		9111.230.270	MIXER LOCKING RING NUT ORANGERAL <i>GHIERA BLOCCAGGIO MIXER ARANCIO RAL</i>
	37		1863.A10	ASS.MIXER FS400 <i>ASS.MIXER A SPIRALE FS400</i>
	38		9111.227.060	MIXER CASING <i>CORPO MIXER</i>
	39		9110.027.060	MIX CASING ASS. <i>ASS.CORPO MIX SAECO CRISTALLO,ATLANTE,QUARZO,RUBINO</i>
	40		9111.232.060	STD TUBE HOLDER SLEEVE <i>MANICOTTO PORTATUBO STANDARD</i>
	40		9111.233.060	DECAFF.TUBE HOLDER SLEEVE <i>MANICOTTO PORTATUBO DECAFFEINATO</i>
	41		U116.006	SCREW AUT.PT TCB 3,5X12 WN 1441 ZNP <i>VITE AUT.PT TCB 3,5X12 WN 1441 ZNP</i>
	42		NR10.014	МЕТАЛЕВИЙ ПЕРЕХІДНИК 1/8" D.6 <i>RACCORDO 1/8" D.6 ORIENTABILE COD. OLAB</i>
	43		NV99.036	HOSECLAMP D=8,5 09993.41.00 <i>HOSECLAMP D=8,5 09993.41.00</i>
	44		9991.035	NUT 1/8 H 4.5 <i>DADO 1/8 H.4,5</i>
	45		11027286	ELETTROVALVE 24V DC TEA <i>ELETTROVALVE 24V DC TEA</i>
	46		20007305	ЧАСТИНА ЕЛЕКТРОМАГНІТНОГО КЛАПАНА З ПОДВИЖНИМ СЕРДЕЧНИК... <i>SPARE EV MOBILE CORE 11023762</i>

Model Machine

MACSAE113

SAECO CRISTALLO 600 ЧЁРНАЯ

MACSAE113.T.0007



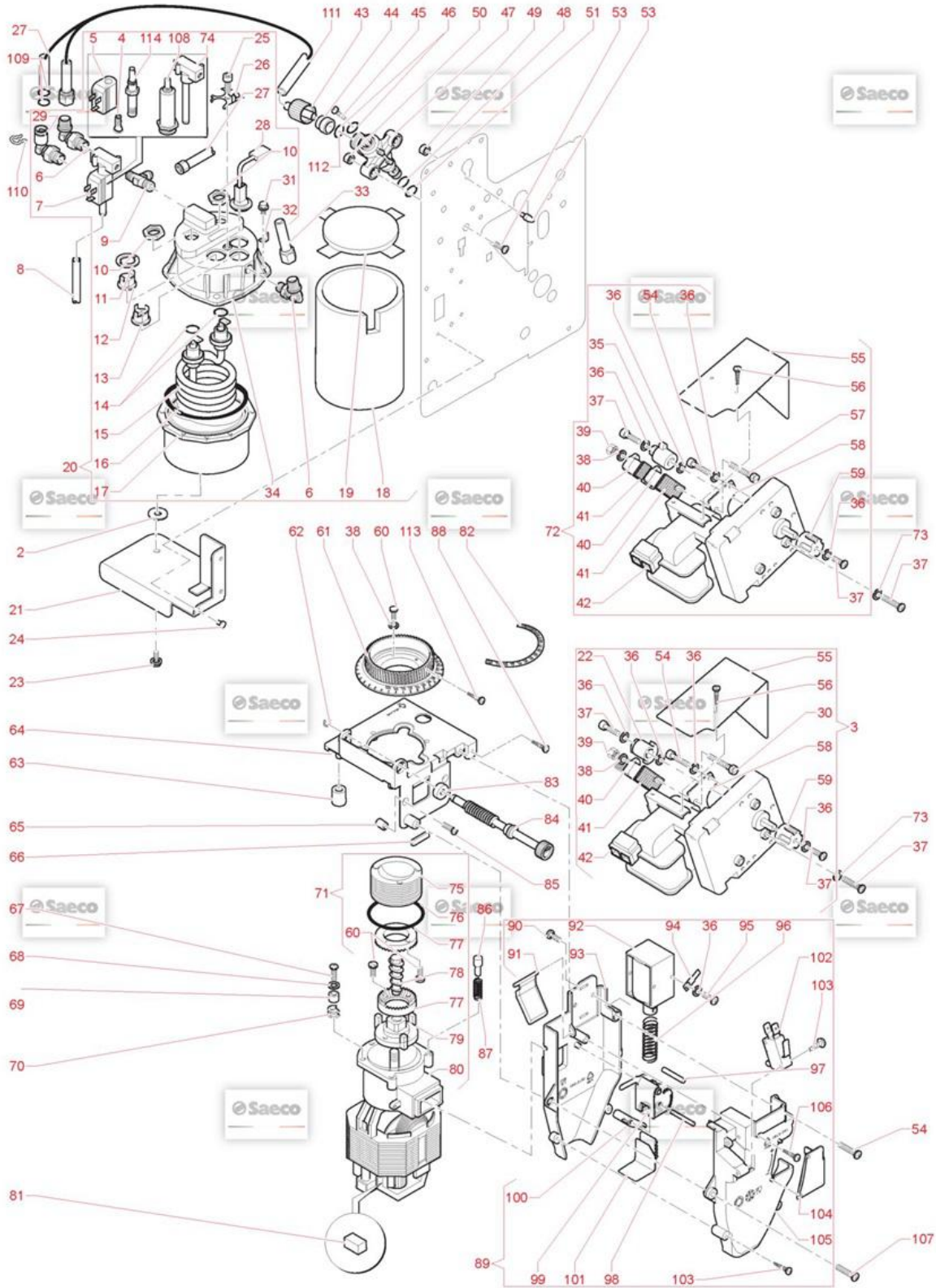









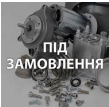













TAVOLA NR. 7 - ARTICOLO SAECO CRISTALLO 600 ЧЁРНАЯ



Model Machine

MACSAE113



















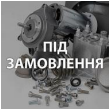



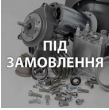



SAECO CRISTALLO 600 ЧЁРНАЯ

Web	Pos.	Foto	Item - Replace by	Description
				<i>Press - CTRL + CLICK go to item in a new window Натисніть - Ctrl + права кнопка миші щоб відкрити запчастину в новому вікні</i>
	1		11025408	TUBE ASSEMBLY TEFLON 3X6 L.290MM <i>TUBE ASSEMBLY TEFLON 3X6 L.290MM</i>
	2		9111.501	INSULATION WASHER <i>INSULATION WASHER</i>
	3		11025216	ASS.RATIOMOTOR FOR DA 230V FS400 <i>ASS.RATIOMOTOR FOR DA 230V FS400</i>
	3		11025217	ASS.RATIOMOTOR FOR DA 220/60 FS400 <i>ASS.RATIOMOTOR FOR DA 220/60 FS400</i>
	3		11025218	ASS.RATIOMOTOR FOR DA 120V FS400 <i>ASS.RATIOMOTOR FOR DA 120V FS400</i>
	4		20007307	SPARE EVT HS1 11023762 <i>SPARE EVT HS1 11023762</i>
	5		20005373	SOLENOID X HS1 11023762 <i>SOLENOID X OLAB 24V DC 6000BH/BODN</i>
	5		20007361	SOLENOID EVT ODE <i>SOLENOID EVT ODE</i>
	6		12001181	BICONICAL CONNECT. L M 1/8X06TEA <i>BICONICAL CONNECT. L M 1/8X06 TEA</i>
	7		11023762	ELECTROVALVE OLAB 3 WAYS 24V DC TEA <i>ELETTROVALVOLA OLAB 3 VIE 24V DC TEA</i>
	7		11032408	ELECTROVALVE ODE 3 WAYS 24V DC <i>ELECTROVALVE ODE 3 WAYS 24V DC</i>
	8		9972.057	КОРИЧНЕВА ГУМОВА ТРУБКА 5X8 2 МЕТРИ <i>TUBO SILICONE MARRON 5X8 L.2000 MM</i>
	9		11011454	"T" CONNECTOR FOR BOILER TEAT"" CONNECTOR FOR BOILER TEA <i>RACCORDO A T X CALDAIA TEA</i>

Model Machine

MACSAE113























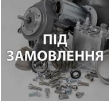

SAECO CRISTALLO 600 ЧЕРНАЯ

	10		9991.029	NUT FOR RESISTOR <i>DADO X RESISTENZA</i>
	11		9991.085	THERMOSTAT FIXING WASHER <i>RONDELLA FERMATERMOSTATI</i>
	12		NE09.021	THERMOSTAT 150°NC FASTON 90° <i>TERMOSTATO 150°NC FASTON 90°</i>
	13		189428700	THERMOSTAT 175° 1NT-15L-5126 <i>THERMOSTAT 175° 1NT-15L-5126</i>
	14	 ПІД ЗАМОВЛЕННЯ	11000972	OR 3050 FKM 80 FD PEROXIDICA <i>OR 3050 FKM 80 FD PEROXIDICA</i>
	15		11007593	RES CALD. V120 W1000 INC.800 <i>RES CALD. V120 W1000 INC.800</i>
	15	 ПІД ЗАМОВЛЕННЯ	9011.255.00A	RES CALD.V230 W1000 <i>RES.CALD. 230V 1000W</i>
	16		NM04.010	OR ORM 0730-40 FPM 70+-5 IRHDBLACK <i>OR ORM 0730-40 FPM 70 +-5 IRHD NERO</i>
	17		9011.226	LOWER OVERSIZE CASING M6 VENDING <i>UPPER OVERSIZE CASING M6 VENDING</i>
	18		11030779	ІЗОЛЯЦІЯ НИЖНЬОЇ ЧАСТИНИ БОЙЛЕРА 600CC <i>COFFEE BOILER 600CC UPPER ISOLATOR</i>
	19		11030777	COFFEE BOILER 600CC UPPER ISOLATOR <i>COFFEE BOILER 600CC UPPER ISOLATOR</i>
	20		11025319	BOILER 230V TEA <i>BOILER ASS. CRISTALLO600 230V</i>
	20	 ПІД ЗАМОВЛЕННЯ	11031131	BOILER CRISTALLO600 C.B. 230V <i>BOILER CRISTALLO600 C.B. 230V</i>
	20	 ПІД ЗАМОВЛЕННЯ	11032545	BOILER PHEDRA ODE 230V <i>BOILER PHEDRA ODE 230V</i>

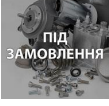
Model Machine

MACSAE113













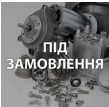













SAECO CRISTALLO 600 ЧЁРНАЯ

	20		11032698	BOILER CRISTALLO ODE 230V <i>BOILER CRISTALLO ODE 230V</i>
	21		11005639	SUPPORT PLATE BOILER <i>SUPPORT PLATE BOILER</i>
	22		9991.037	CAM FOR RATIONMOTOR 1 MICRO <i>CAMMA X MOTORIDUTTORE 1 MICRO</i>
	23		U046.005	SCREW TE M5,0X10 WITH WASHER <i>SCREW TE M5,0X10 WITH WASHER</i>
	24		NF11.115	BLIND RIVETS <i>BLIND RIVETS</i>
	25		12001052	SCREW TCEI M4,0X6 DIN 912 ZIN <i>SCREW TCEI M4,0X6 DIN 912 ZIN</i>
	26		226830200	RETAIN.SPRING 3 THERM. +THERMAL FUSE <i>RETAIN.SPRING 3 THERM. +THERMAL FUSE</i>
	27		11025292	TEFLON TUBE 3X6 L.230 1/8"-1/8 <i>TEFLON TUBE 3X6 L.230 1/8"-1/8</i>
	28		11000090	ASS.SENSOR FS400 <i>ASS.SENSORE X FS400</i>
	28		11003810	SENSOR ASS.CRISTALLO400 120V <i>SENSOR ASS.CRISTALLO400 120V</i>
	29		11029569	CONNECTOR <i>RACC.ORIENT.DADO/OGIV.1/8"CONICO TUBO D4</i>
	30		U034.003	SCREW TCI M3,0X20 UNI 6107 GALV. <i>SCREW TCI M3,0X20 UNI 6107 GALV.</i>
	31		U023.020	SCREW TCEI M6X20 UNI 5931 ZIN <i>VITE TCEI M6X20 UNI 5931 8.8</i>

Model Machine

MACSAE113

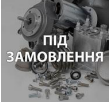











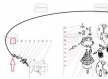













SAECO CRISTALLO 600 ЧЁРНАЯ

	32		NE15.031	MALE TONGUE PLAIN 6,3 D.6,3 MALE TONGUE PLAIN 6,3 D.6,3
	33		11025297	TEFLON TUBE 3X6 L.310 1/8"-1/8 TEFLON TUBE 3X6 L.310 1/8"-1/8
	34		11002259	UPPER DOSER CASING M6 TEA UPPER DOSER CASING M6 TEA
	35		11003525	CAM COFFEE GROUP FRESH BREW CAM COFFEE GROUP FRESH BREW
	35		9991.012.050	CAM FOR RATIOMOTOR BLACK CAMMA X MOTORIDUTTORE NERA
	36		128310404	МЕТАЛЕВЕ УБЧАСТЕ КОЛІЩАТКО UNI 8842 A4 WASHER UNI 8842 A4 BURNISHED
	37		129824002	TCB SCREW M4X10 UNI 7687 ZNP VITE TCB M4X10 UNI 7687 ZNP
	38		U208.002	TOOTHED WASHER 3,3X5,8 UNI 3703 G ROSETTA DENT. 3,3X5,8 UNI 3703 ZNP
	39		U302.002	NUT HEXAGONAL M3 UNI 5588 NUT HEXAGONAL M3 UNI 5588
	40		NE05.066	MICROSWITCH CHERRY D419Q1A МІКРОПЕРЕМИКАЧ РЕДУКТОРА РОБОЧОЇ ГРУПИ
	41		9991.014	CARD FOR MICRO SWITCHES CARTONCINO X MICROINTERRUTTORE
	42		11032817	RATIOMOTOR 30 PACK 230/240-50 RATIOMOTOR 30 PACK 230/240-50
	42		11032818	RATIOMOTOR 30 PACK 120/60 RATIOMOTOR 30 PACK 120/60
	42		11032819	RATIOMOTOR 30 PACK 220/60 MOTORIDUTT.IN PLASTICA PACCO 30 220/60

Model Machine

MACSAE113







SAECO CRISTALLO 600 ЧЁРНАЯ

	43		11005743	KNURLED FEMALE HAND BOLT M14 GODRONE FEMMINA M14
	43		11029574	ГАЙКА ДЛЯ РУЧНОГО ЗАЖИМУ М14 ДЛЯ ТРУБКИ 4Х2 GODRONE FEMMINA M14 X TUBO 4X2
	44		11005741	CONNECTOR D.6 BOCCOLA ESTERNA D.6
	45		U109.037	SCREW AUT.TCB 4,8X13 DIN 7981C VITE AUT.TCB 4,8X13 DIN 7981 C NIK
	46		140321462	O-RING 2018 SILICONE OR 2018 IN SILICONE
	47		11005370	PIN FOR MUFF PERNO X MANICOTTO PIN FOR MUFF
	48		11013173	OR ORM 0090-20 FKM 80 FD GREENPEROXIDA OR ORM 0090-20 FKM 80 FD GREEN PEROXIDA
	49		U302.001	NUT HEXAGONAL M5 UNI 5588 DADO ESAGONALE M5 UNI 5
	50		U302.003	GALV.NUT HEXAGONAL M4 UNI 5589ZN DADO ESAGONALE M4 UNI 5588 ZNP
	51		11013174	OR ORM 0050-20 FKM 80 FD GREENPEROXIDA OR ORM 0050-20 FKM 80 FD GREEN PEROXIDA
	52		11006046	PEG FOR BOILER PEG FOR BOILER
	53		U044.013	SCREW TSPC M4,0X12 UNI 7688 GALV. VITE TSPC M4,0X12 UNI 7688 ZNP
	54		129825502	TCB SCREW M4X25 UNI 7687 ZNP TCB SCREW M4X25 UNI 7687 ZNP
	55		11004265	CENTRAL UNIT MOTOR STEEL CARTER CENTRAL UNIT MOTOR STEEL CARTER

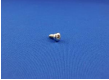
Model Machine

MACSAE113





























SAECO CRISTALLO 600 ЧЁРНАЯ

	55		11014251	CENTRAL UNIT MOTOR STEEL CARTER <i>CENTRAL UNIT MOTOR STEEL CARTER</i>
	56		129511903	SCREW TCB 2,9X6,4 DIN 7981 BZNICK <i>SCREW TCB 2,9X6,4 DIN 7981 BZ NICK</i>
	57		U034.001	SCREW TCI M3,0X30 UNI 6107 GALV. <i>VITE TCI M3,0X30 UNI 6107 ZNP</i>
	58		11003524	PLATE FOR MICRO RATIOMOTOR <i>PLATE FOR MICRO RATIOMOTOR</i>
	58		9991.015	PLATE FOR MICRO <i>PIASTRINA X MICRO</i>
	59		9991.013	JOINT FOR RATIOMOTOR <i>GIUNTO X MOTORIDUTTORE</i>
	60		U043.007	SCREW TCBC M3,0X8 UNI 7687 GALV. <i>SCREW TCBC M3,0X8 UNI 7687 GALV.</i>
	61		11027723	RING NUT OF GRIND REGULATION <i>RING NUT OF GRIND REGULATION</i>
	61		1813.103.A20	RING NUT OF GRIND REGULATION <i>RING NUT OF GRIND REGULATION</i>
	62		U701.011	STEEL SNAP RING 5 UNI 7434 <i>ANELLO ELASTICO 5 UNI 7434</i>
	63		1813.046.050	RUBBER GRIND SUPPORT <i>RUBBER GRIND SUPPORT</i>
	64		1813.045.A20	GRIND SUPPORT <i>GRIND SUPPORT</i>
	65		1813.097.A20	SPACER <i>SPACER</i>

Model Machine

MACSAE113











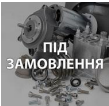













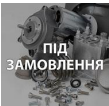

SAECO CRISTALLO 600 ЧЁРНАЯ

	66		1813.177	SUPPORT SEAL SUPPORT SEAL
	67		12002052	ZN-B TCB SCREW M4X16 ZN-B TCB SCREW M4X16
	68		U203.001	ШАЙБА 4,3X8 UNI 1749 GA PLAIN WASHER 4,3X8 UNI 1749 GAL
	69		9141.003	SPACER FOR RUBBER SPACER FOR RUBBER
	70		9991.005	RUBBER FOR COFFEE GRINDER GOMMINO X MACINA CAFFE
	71		9140.001.00A	COFFEGRINDER MOTOR ASS.220/230V ASS.MOTORE MACINACAFFE'220/2
	71		9140.001.00F	COFFEGRINDER MOTOR ASS.120V COFFEGRINDER MOTOR ASS.120V
	72	 ПІД ЗАМОВЛЕННЯ	11003768	ASS.RATIOMOTOR CRISTALLO400 120V ASS.RATIOMOTOR CRISTALLO400 120V
	72	 LIBERTY	11005172	ASS.RATIOMOTOR CRISTALLO400 220/60 ASS.RATIOMOTOR CRISTALLO400 220/60
	72	 ПІД ЗАМОВЛЕННЯ	11023413	RATIOMOTOR CRISTALLO600 TTT 120V CSA RATIOMOTOR CRISTALLO600 TTT 120V CSA
	72	 ПІД ЗАМОВЛЕННЯ	11023414	RATIOMOTOR CRISTALLO600 TTT 230V RATIOMOTOR CRISTALLO600 TTT 230V
	72		9120.060.00A	ASS.RATIOMOTOR FOR DA 230V FS400 ASS.MOTORIDUTTORE X DA 230V FS400
	73		U207.002	PLAIN WASHER 4,3X9 UNI 6592 GAL ROSETTA PIANA 4,3X9 UNI 6592 ZNP
	74	 ПІД ЗАМОВЛЕННЯ	20007364	SPARE EVT 11032408 SPARE EVT 11032408

Model Machine

MACSAE113

















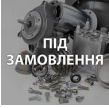





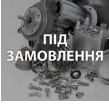

SAECO CRISTALLO 600 ЧЁРНАЯ

	75		9141.008	KNOB ADJUSTMENT SCREW <i>KNOB ADJUSTMENT SCREW</i>
	76		140321560	O-RING 3187 NBR <i>OR 3187 IN NBR</i>
	77		9141.081	МЕТАЛЕВИЙ ПОДРІБНЮВАЧ D.43 TIN SAECO (1 ШТ) <i>MACINA PIANA D.43 TIN NB) PREZZO ACQUISTO PER 1 PEZZO</i>
	78		9141.001	BRASS NCREMENT SCREW MC <i>BRASS NCREMENT SCREW MC</i>
	79		9141.007	FAN <i>VENTOLINA</i>
	80		9140.002.00A	MOTOR ASS.WITH CAP 230V <i>ASS.MOTORE CON CALOTTA 230V</i>
	80		9140.002.00F	MOTOR ASS.WITH CAP 120V <i>MOTOR ASS.WITH CAP 120V</i>
	81		0701.R34	MOTOR BRUSH <i>SPAZZOLA X MOTORE MACINACAFFE'</i>
	82		15000422	LABEL GRADUATION GRINDING <i>LABEL GRADUATION GRINDING</i>
	83		1813.159	ANTIVIBRATION RUBBER <i>ANTIVIBRATION RUBBER</i>
	84		1813.104.A20	ADJUSTMENT SCREW WITH TUBE HOLDER <i>VITE REGOLAZIONE MACININO</i>
	85		U044.022	SCREW TSPC M5,0X8 UNI 7688 GALV. <i>SCREW TSPC M5,0X8 UNI 7688 GALV.</i>
	86		9141.005	KNOB PIN <i>PERNO MANOPOLA</i>
	87		126769118	SPRING FOR KNOB STOP PIN (H=19) <i>SPRING FOR KNOB STOP PIN (H=19)</i>

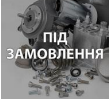
Model Machine

MACSAE113























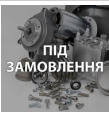

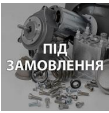

SAECO CRISTALLO 600 ЧЁРНАЯ

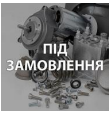
	88		U116.006	SCREW AUT.PT TCB 3,5X12 WN 1441 ZNP <i>VITE AUT.PT TCB 3,5X12 WN 1441 ZNP</i>
	89		11033675	DOSER <i>DOSER</i>
	89		11033677	DOSER <i>DOSER</i>
	89		1813.A10.A2N	DOSER ASS. 6-11 GR. 220V 60HZ <i>DOSER ASS. 6-11 GR. 220V 60HZ</i>
	90		12002151	TSP SCREW M3X4 UNI 7688 SS <i>TSP SCREW M3X4 UNI 7688 SS</i>
	91		1813.042.A20	DISPENSER PALLET <i>DISPENSER PALLET</i>
	92		9121.235.00A	ELECTROMAGNET FOR DISPENSER WITH NUCLEUS <i>ELETTROM. PER DOSATORE CON NUCLEO</i>
	92		9121.235.00F	ELECTROMAGNET X DISPENSER W/NUCLEUS 120V <i>ELECTROMAGNET X DISPENSER W/NUCLEUS 120V</i>
	92		9121.235.00N	ЕЛЕКТРОМАГНІТ ДЛЯ ДОЗАТОРА W/NUCLEUS 220V <i>ELECTROMAGNET X DISPENSER W/NUCLEUS 220V</i>
	93		11033683	DISPENSER SHELL <i>DISPENSER SHELL</i>
	94		NE15.003	MALE TONGUE PLAIN 6,3 D.5,2 <i>LINGUETTA MASCHIO PIANA 6,3 D.5,2</i>
	95		129821402	TCB SCREW M3X4 UNI 7687 ZNP <i>TCB SCREW M3X4 UNI 7687 ZNP</i>
	96		1813.127	SPRING FOR ELECTROMAGNET <i>MOLLA X ELETTROMAGNETE DOSAT</i>

Model Machine

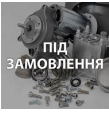
MACSAE113

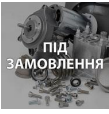











SAECO CRISTALLO 600 ЧЁРНАЯ

	97		1813.092	PIN <i>PIN</i>
	98		1813.091	PIN FOR DISPENSER REGULATION <i>PIN FOR DISPENSER REGULATION</i>
	99		1813.043.A20	DISPENSER REGULATION <i>REGOLATORE DOSATORE</i>
	10001		1813.078.A20	ADJUSTMENT LEVER <i>ADJUSTMENT LEVER</i>
	1010		1813.044.A20	PALLET FOR REGULATION <i>PALETTA X REGOLATORE</i>
	1020		NE05.062	MICROSWITCH + WHEEL <i>MICROINTERRUTTORE C/ROTELLA</i>
	1030		U116.004	SCREW AUT.PT TCB 3,0X16 WN 1441 <i>SCREW AUT.PT TCB 3,0X16 WN 1441</i>
	1040		1813.191.A20	DISPENSER COVER <i>COPERTURA DOSATORE</i>
	1050		11033684	OUTSIDE SHELL DISPENSER <i>GUSCIO EST.DOSATORE 1813.041.A20 LAV.</i>
	1060		12000390	SCREW AUT.TCB 2,9X25 DIN 7981C NIK <i>SCREW AUT.TCB 2,9X25 DIN 7981 C NIK</i>
	1070		12002039	SCREW TCBD TORX 20 M4X12 ZN-B <i>VITE TCBD TORX 20 M4X12 ZN-B</i>
	1080		20007306	SPARE EVT HS1 11023762 <i>SPARE EVT HS1 11023762</i>
	1080		20007363	SPARE EVT ODE <i>SPARE EVT ODE</i>
	1090		140328059	OR 2015 SILICONE PTFE/FDA <i>OR 2015 SILICONE PTFE/FDA</i>

Model Machine

MACSAE113

SAECO CRISTALLO 600 ЧЁРНАЯ

	1100		9011.144	SS FORK FOR TUBE D=4 <i>FORCELLA X TUBO D.4</i>
	1110		9972.236	BLACK SILICONE TUBE 7,5X9,3 L=200 MM <i>BLACK SILICONE TUBE 7,5X9,3 L=200 MM</i>
	1120		12001810	OR 275 DE.8,04 SILICONE PERNOMANICOTTO <i>OR 275 DE.8,04 SILICONE PERNO MANICOTTO</i>
	1130		U109.004	SCREW AUT.TCB 4,8X9,5 DIN 7981C <i>VITE AUT.TCB 4,8X9,5 DIN 798</i>
	1140		20007305	ЧАСТИНА ЕЛЕКТРОМАГНІТНОГО КЛАПАНА З ПОДВИЖНИМ СЕРДЕЧНИК... <i>SPARE EV MOBILE CORE 11023762</i>
	1140		20007362	SPARE CORE EV ODE <i>RIC. NUCLEO EVT ODE</i>

Model Machine

MACSAE113

SAECO CRISTALLO 600 ЧЁРНАЯ

MACSAE113.T.0008

TAVOLA NR. 8 - ARTICOLO SAECO CRISTALLO 600 ЧЁРНАЯ

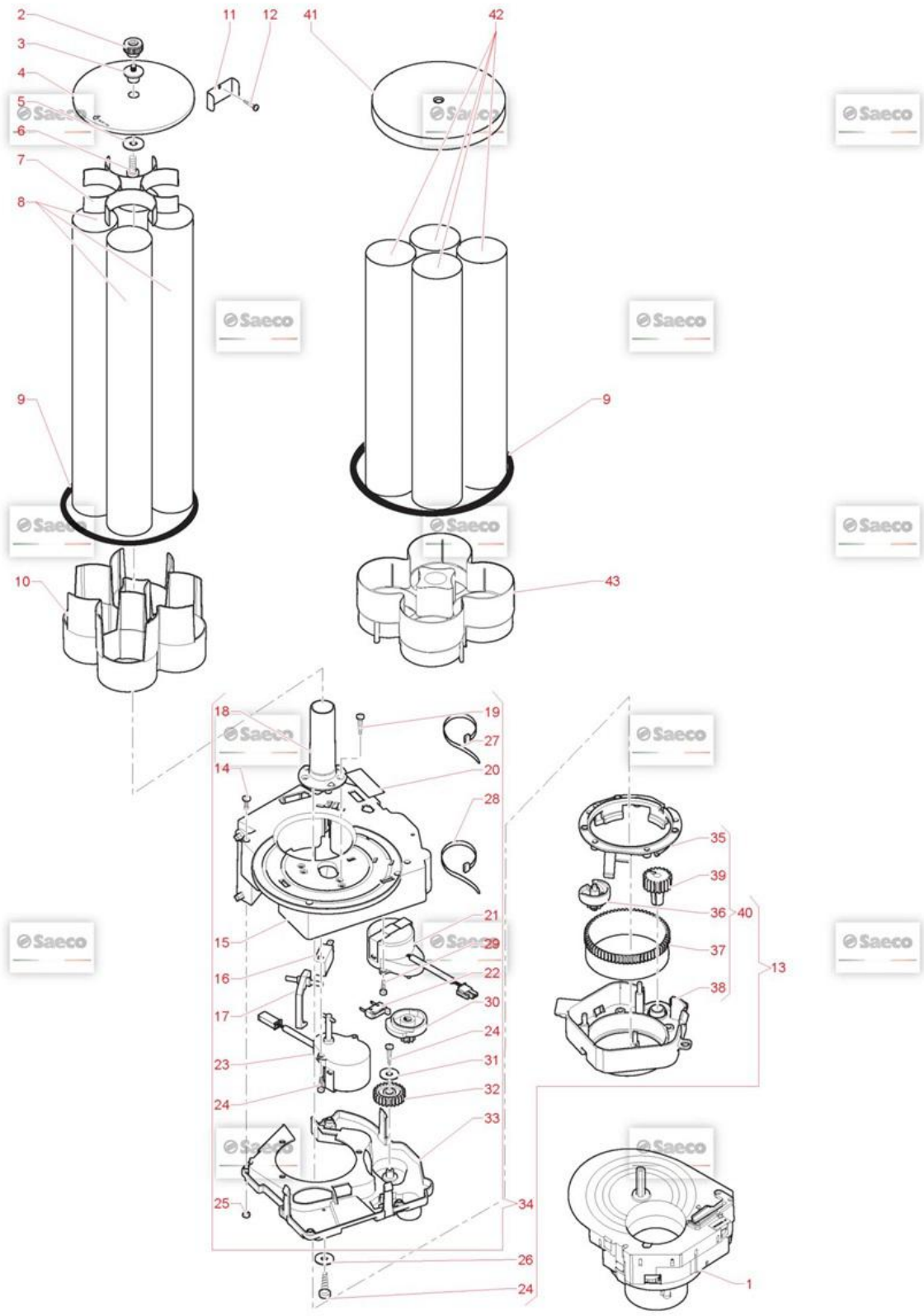

Model Machine

MACSAE113

SAECO CRISTALLO 600 ЧЁРНАЯ

Web Pos. Foto Item - Replace by Description



Press - CTRL + CLICK go to item in a new window

Натисніть - Ctrl + права кнопка миші щоб відкрити запчастину в новому вікні



1

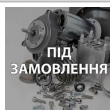

11028668

DISPENSER GLASSES D.83 120V ETL
DISPENSER GLASSES D.83 120V ETL



2



12002034

KNOB WITH BUSH M5
KNOB WITH BUSH M5



3



11010585

CENTRAL PIN FOR CUP COLUMN
CENTRAL PIN FOR CUP COLUMN



4



11028032

TANK LID GLASSES
TANK LID GLASSES



5

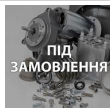

U207.009

PLAIN WASHER 5,5X15 UNI 6593 GA
PLAIN WASHER 5,5X15 UNI 6593 GA



6



U043.021

SCREW TCBC M5,0X8 UNI 7687 GALV.
VITE TCBC M5,0X8 UNI 7687 ZNP



7



11005072

CUP TUBE FIXING SPRING
CUP TUBE FIXING SPRING



8



11001422

TUBE PVC 80X1.5 L=705
TUBE PVC 80X1.5 L=705



9

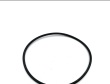

NM02.002

OR 4412 EPDM
OR 4412 EPDM



10



11000976

TANK DRINKS
SERBATOIO BICCHIERI UNIFICATO



11

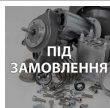

1813.162

BRACKET STOP DISPENSER
BRACKET STOP DISPENSER



12



U110.004

SCREW AUT.TCB 3,5X6,5 DIN 7981F
VITE AUT.TCB 3,5X6,5 DIN 7981 F NIK



13

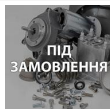











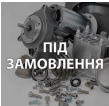















11004750

ASS. CUP DISPENSER 120V D.73
ASS. CUP DISPENSER 120V D.73

Model Machine

MACSAE113

















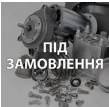

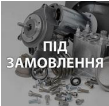





SAECO CRISTALLO 600 ЧЁРНАЯ

	13		9110.140.A2A	CUP DISTRIBUTOR <i>ASS.DISTRIBUTORE BICCHIERI FS400</i>
	14		U034.001	SCREW TCI M3,0X30 UNI 6107 GALV. <i>VITE TCI M3,0X30 UNI 6107 ZNP</i>
	15		11000785	ВЕРХНІЙ КОРПУС БЛОКУ ВИДАЧІ СТАКАНІВ <i>CORPO SUPERIORE DISTRIBUTORE BICCHIERI</i>
	15		11000868	CASING UPPER CUP DISTRIBUTOR UL <i>CASING UPPER CUP DISTRIBUTOR UL</i>
	16		NE05.065	MICROSWITCH CHERRY D41R-QGAD_61 <i>MICROINTERRUTTORE CHERRY D419Q1A ATLANTE CRISTALLO NEXTAGE</i>
	17		1813.067.A20	LEVER <i>LEVA PRESENZA BICCHIERI</i>
	18		11000642	TUBE FOR BASKET GLASSES <i>CANOTTO PER CESTELLO BICCHIERI</i>
	19		U142.008	PANELVIT TSP 3,5X12 DIN 7505 AGAL <i>PANELVIT TSP 3,5X12 DIN 7505 A GAL</i>
	20		11001467	ADHESIVE LABEL PVC 54X30 MM <i>ADHESIVE LABEL PVC 54X30 MM</i>
	21		9121.226.00A	MOTOR SAIA UDS 5 RPM 220V <i>MOTORE SAIA UDS 5 RPM 220V</i>
	21		9121.226.00F	RATIOMOTOR SAIA UDS 5RPM 120V60HZ <i>RATIOMOTOR SAIA UDS 5RPM 120V 60HZ</i>
	22		NE05.064	MICROSWITCH SAIA V4NC <i>MICROINTERRUTTORE SAIA V4NC</i>
	23		11000391	MOTOR SAIA UDS1ND5M75CAN2WZ239 <i>MOTORE SAIA UDS1ND5M75CAN2WZ239</i>
	23		11000481	MOTOR SAIA CUP DISPENSER D6 PIVOT 120V <i>MOTOR SAIA CUP DISPENSER D6 PIVOT 120V</i>

Model Machine

MACSAE113











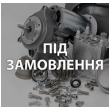









SAECO CRISTALLO 600 ЧЁРНАЯ

	24		U116.005	SCREW AUT.PT TCB 3,0X8 WN 1441 VITE AUT.PT TCB 3,0X8 WN 1441 ZNP
	25		U324.005	NUT M3 FLANGED INDENTED BASE DADO M3 FLANGIATO BASE DENTELLATA
	26		U212.006	WASHER 3,2X11X0,5 ZNP WASHER 3,2X11X0,5 ZNP
	27	 ПІД ЗАМОВЛЕННЯ	NF11.002	SELF LOCK STRIP W=2.5 L=98 SELF LOCK STRIP W=2.5 L=98
	28	 ПІД ЗАМОВЛЕННЯ	144320200	SELF LOCK STRIP W=2.6 L=200 SELF LOCK STRIP W=2.6 L=200
	29		U109.005	SCREW AUT.TCB 3,5X16 DIN 7981C VITE AUT.TCB 3,5X16 DIN 798
	30		1863.066.A20	DISENGAGE CAM GLASSES DISENGAGE CAM GLASSES
	31		U201.001	PLAIN WASHER 3,2X9 DIN 7349 GALV. PLAIN WASHER 3,2X9 DIN 7349 GALV.
	32	 ПІД ЗАМОВЛЕННЯ	1813.068.A20	TOOTHED WHEEL TOOTHED WHEEL
	33	 ПІД ЗАМОВЛЕННЯ	1813.062.A20	LOWER CASING DISPENSER GLASSES LOWER CASING DISPENSER GLASSES
	33	 ПІД ЗАМОВЛЕННЯ	1813.308.050	LOVER CASING DISPENSER GLASSESUL LOVER CASING DISPENSER GLASSES UL
	34	 ПІД ЗАМОВЛЕННЯ	11003955	FS400 UL ASSEMBL.CUP DISP. GROUP FS400 UL ASSEMBL.CUP DISP. GROUP
	34	 ПІД ЗАМОВЛЕННЯ	9110.151.A2A	DISPENSER ASS. DISPENSER ASS.

Model Machine

MACSAE113

SAECO CRISTALLO 600 ЧЁРНАЯ

	35		11000786	RETAINING RING <i>RETAINING RING</i>
	36		1813.072.A20	SNAIL FOR GLASSES D.70 <i>CHIOCCIOLA X BICCHIERI</i>
	36		1813.192.050	SNAIL FOR GLASSES D.73 <i>CHIOCCIOLA X BICCHIERI D.73</i>
	37		1813.073.A20	TOOTHED WHEEL FOR SNAIL <i>TOOTHED WHEEL FOR SNAIL</i>
	38		11000833	SNAIL SUPPORT <i>SNAIL SUPPORT</i>
	39		1813.074.A20	TOOTHED WHEEL <i>TOOTHED WHEEL</i>
	40		11000835	ASS.SNAIL SUPPORT <i>ASS.SNAIL SUPPORT</i>
	40		11000863	ASSEMBLY SUPPORT <i>ASSEMBLY SUPPORT</i>
	41		11027368	TANK LID GLASSES D.80 <i>COPERCHIO CESTELLO BICCHIERI D.80</i>
	42		11028131	TUBE PVC 80X1.5 L=620 <i>TUBO PVC 84X1.5 L=620</i>
	43		11026360	BASE GLASSES BASKET 4 COLUMN D.80 <i>BASE CESTELLO BICCHIERI 4 COL. D.80</i>

Model Machine

MACSAE113

SAECO CRISTALLO 600 ЧЁРНАЯ

MACSAE113.T.0009



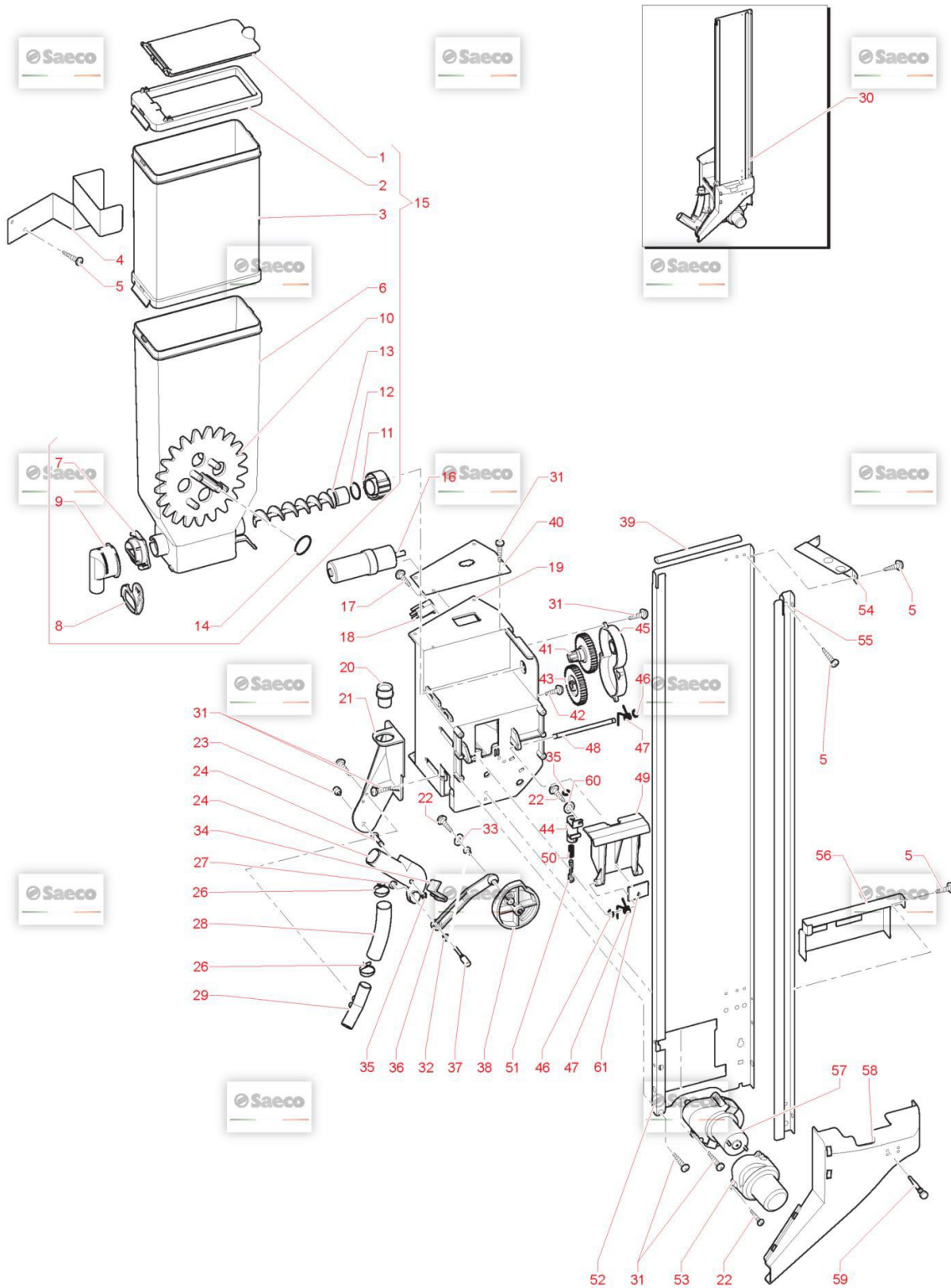























TAVOLA NR. 9 - ARTICOLO SAECO CRISTALLO 600 ЧЁРНАЯ



Model Machine

MACSAE113











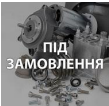

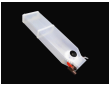













SAECO CRISTALLO 600 ЧЁРНАЯ

Web	Pos.	Foto	Item - Replace by	Description
				<i>Press - CTRL + CLICK go to item in a new window Натисніть - Ctrl + права кнопка миші щоб відкрити запчастину в новому вікні</i>
	1		9111.683	SOLUBLE COVER <i>COPERCHIETTO SOLUBILI</i>
	2		9111.696	COVER SUGAR CONTAINER <i>COPERCHIO CONTENITORE ZUCCHERO</i>
	3		11004610	EXTENSION FOR CONTAINER SUGAR <i>PROLUNGAX CONTENITORE ZUCCHERO</i>
	4		11005130	PLATE STOP CONTAINER SUGAR CRISTALLO600 <i>PLATE STOP CONTAINER SUGAR CRISTALLO600</i>
	5		U110.004	SCREW AUT.TCB 3,5X6,5 DIN 7981F <i>VITE AUT.TCB 3,5X6,5 DIN 7981 F NIK</i>
	6		9111.685	SUGAR CONTAINER <i>CONTENITORE ZUCCHERO</i>
	7		9111.630.060	BUSH FOR POWDERS TANK <i>BOCCOLA X SERBAT.POLVERI C/AGGANCI</i>
	8		9111.338.270	BULKHEAD FOR APERT. CLOSURE ORANGE <i>PARATIA CHIUSURA BOCCHETTA ARANCIO</i>
	9		9111.629.060	APERTURE FOR SOLUBLES HOPPER <i>APERTURE FOR SOLUBLES HOPPER</i>
	10		11032878	ШЕСТЕРНЯ КОНТЕЙНЕРА ДЛЯ ЦУКРУ (EX 9111.725) <i>CONTAINER WHEEL SUGAR BPA FREE</i>
	11		11012130	BACK BUSH REINFORCE <i>BACK BUSH REINFORCE</i>
	12		NM03.013	OR 2,3X15 NBR <i>OR 2,3X15 NBR</i>
	13		9111.726	SCROLL SCREW SUGAR CONTAINER <i>COCLEA CONTENITORE ZUCCHERO</i>

Model Machine

MACSAE113



















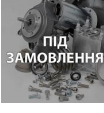

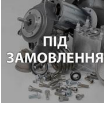

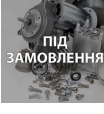

SAECO CRISTALLO 600 ЧЁРНАЯ

	14		9111.646	ADHESIVE FOR TANK <i>ADHESIVE FOR TANK</i>
	15		11005129	ASSEMBLY SUGAR CONTAINER <i>ASS.CONT.ZUCCHERO CON PROLUNGA</i>
	16		9121.106.00P	SUGAR RATIOMOTOR 24V DC <i>MOTORIDUTTORE ZUCCHERO 24V D.C.</i>
	17		U110.007	SCREW AUT.TCB 2,9X16 DIN 7981F ZNP <i>SCREW AUT.TCB 2,9X16 DIN 7981 F ZNP</i>
	18		NE05.002	МІКРОВИМИКАЧ ДЛЯ КАВОМАШИНИ EF83161.8 <i>MICROINTERRUTTORE</i>
	19		11033196	СУПОРТ МЕХАНІЗМА МЕШАЛКИ САХАРА <i>SUPP.PALETTIERA</i>
	19		9111.684.A20	SUPPORT STIRRER <i>SUPPORTO PALETTIERA</i>
	20		9111.699	APERTURE SUGAR TUBE <i>BOCCHETTA TUBO ZUCCHERO</i>
	21		9111.686.A20	SUPPORT SUGAR CONVEYER <i>SUPPORTO BASCULINA ZUCCHERO</i>
	22		U116.004	SCREW AUT.PT TCB 3,0X16 WN 1441 <i>SCREW AUT.PT TCB 3,0X16 WN 1441</i>
	23		11000388	KNOB M3 SUGAR CONVEYER <i>POMELLO M 3 BASCULINA ZUCCHERO</i>
	24		11000389	GRAINED PIVOT SUGAR COVEYER <i>PERNO ZIGRINATO BASCULINA ZUCCHERO</i>
	25		9111.690	SUGAR CONVEYER <i>BASCULINA ZUCCHERO</i>
	26		9111.553	SELF-ENERGIZING SPRING FOR TUBE D.2 <i>SELF-ENERGIZING SPRING FOR TUBE D.2</i>

Model Machine

MACSAE113

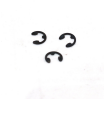



























SAECO CRISTALLO 600 ЧЁРНАЯ

	27		123160302	NUT M3 HIGH UNI 5587 GALVANIZED <i>NUT M3 HIGH UNI 5587 GALVANIZED</i>
	28		9111.700	SUGAR TUBE <i>TUBO ZUCCHERO</i>
	29		9111.697	CONNECTOR SUGAR TUBE <i>RACCORDO TUBO ZUCCHERO</i>
	30		11001411	DISTRIBUTOR ASS. <i>ASSIEME DISTRIBUTORE ZUCCHERO PALETTE</i>
	30		11004629	ASSEMBLY SUGAR/SPOONS DISPENDER 120V UL <i>ASSEMBLY SUGAR/SPOONS DISPENDER 120V UL</i>
	30		11033206	DISTRIBUTOR 25RPM <i>DISTRIBUTOR 25RPM</i>
	30		11033207	ASSEMBLY SUGAR/SPOONS DISPENDER 120V UL <i>ASSEMBLY SUGAR/SPOONS DISPENDER 120V UL</i>
	31		U116.006	SCREW AUT.PT TCB 3,5X12 WN 1441 ZNP <i>VITE AUT.PT TCB 3,5X12 WN 1441 ZNP</i>
	32		9111.705	SPHERICAL PIN <i>PERNO SFERICO</i>
	33		U201.001	PLAIN WASHER 3,2X9 DIN 7349 GALV. <i>PLAIN WASHER 3,2X9 DIN 7349 GALV.</i>
	34		9111.727	BULKHEAD SUGAR CONVEYER <i>PARATIA BASCULINA ZUCCHERO</i>
	35		U701.011	STEEL SNAP RING 5 UNI 7434 <i>ANELLO ELASTICO 5 UNI 7434</i>
	36		9111.691	CONNECTING ROD SUGAR DISPENCER <i>BIELLA DISTRIBUTORE ZUCCHERO</i>

Model Machine

MACSAE113

SAECO CRISTALLO 600 ЧЁРНАЯ

	37		11004295	KNOB FOR SUGAR CONNECTING RODPIPE <i>POMELLO BLOCCAGGIO BIELLA TUBO ZUCCH.</i>
	38		9111.688.A20	CAM SUGAR DISPENCER <i>CAMMA DISTRIBUTORE ZUCCHERO</i>
	39		9111.668	STIRRER DISP.COUNTERWEIGHT D.10 <i>CONTRAPPESO PALETTE D.10</i>
	39		9111.669	STIRRER DISP.COUNTERWEIGHT D.10 <i>STIRRER DISP.COUNTERWEIGHT D.10</i>
	39		9111.745	STIRRER DISP.COUNTERWEIGHT <i>CONTRAPPESO PALETTE L=113MM</i>
	40		9111.707	REINFORCING PLATE <i>PIASTRA RINFORZO PALETTIERA</i>
	41		9111.694	JOINT WITH GEAR <i>GIUNTO CON INGRANAGGIO</i>
	42		U116.005	SCREW AUT.PT TCB 3,0X8 WN 1441 <i>VITE AUT.PT TCB 3,0X8 WN 1441 ZNP</i>
	43		9111.695	GEAR Z40 <i>INGRANAGGIO Z 40</i>
	44		9111.737	SUPPORT <i>SUPPORT</i>
	45		9111.687.A20	GEAR COVER <i>COPERCHIO INGRANAGGI</i>
	46		U701.006	SNAP RING 3,2 UNI 7434 <i>ANELLO ELASTICO 3,2</i>
	47		9111.730	SPRING <i>MOLLA ESPULSORE PALETTE</i>
	48		9111.376	PIN FOR STIRRER EXPELLER <i>PIN FOR STIRRER EXPELLER</i>

Model Machine

MACSAE113

SAECO CRISTALLO 600 ЧЁРНАЯ

	49		11011240	STIRRER EXPELLER BLACK NEW <i>STIRRER EXPELLER BLACK NEW</i>
	50		11031341	SPRING <i>SPRING</i>
	51		11002209	PIN <i>PIN</i>
	52		11009887	STIRRER GUIDE CRISTALLO600 NEW <i>STIRRER GUIDE CRISTALLO600 NEW</i>
	53		11025411	CRISTALLO SPOON'S MOTOR COVER <i>CRISTALLO SPOON'S MOTOR COVER</i>
	54		11004620	BRACKET FOR STIRRER GUIDE DOOR <i>BRACKET FOR STIRRER GUIDE DOOR</i>
	55		11001420	STIRRER GUIDE CRISTALLO600 <i>STIRRER GUIDE CRISTALLO600</i>
	56		9111.739	CARTER STIRRER EXPULSION <i>CARTER STIRRER EXPULSION</i>
	57		11025284	MOTORIDUTTORE FIBER 37RPM <i>MOTORIDUTTORE FIBER 37RPM</i>
	57		11033191	GEARMOTOR MECHTEX 25 RPM <i>MOTORIDUTTORE MECHTEX 25 RPM</i>
	57		9121.107.00P	STIRRER RATIOMOTOR FIBER <i>MOTORIDUTTORE PALETTE FIBER</i>
	58		9111.698.A20	STIRRER SLIDE <i>SCIVOLO PALETTE</i>
	59		9161.082	RUBBER COUPLER <i>AGGANCIO IN GOMMA</i>
	60		U207.003	PLAIN WASHER 3,2X7 UNI 6592 GALV. <i>PLAIN WASHER 3,2X7 UNI 6592 GALV.</i>

Model Machine

MACSAE113

SAECO CRISTALLO 600 ЧЁРНАЯ



61

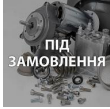

11025089

PLATE REINFORCEMENT

PIASTRINA RINFORZO ESPULSORE

Model Machine

MACSAE113

SAECO CRISTALLO 600 ЧЁРНАЯ

MACSAE113.T.0010

TAVOLA NR. 10 - ARTICOLO SAECO CRISTALLO 600 ЧЁРНАЯ

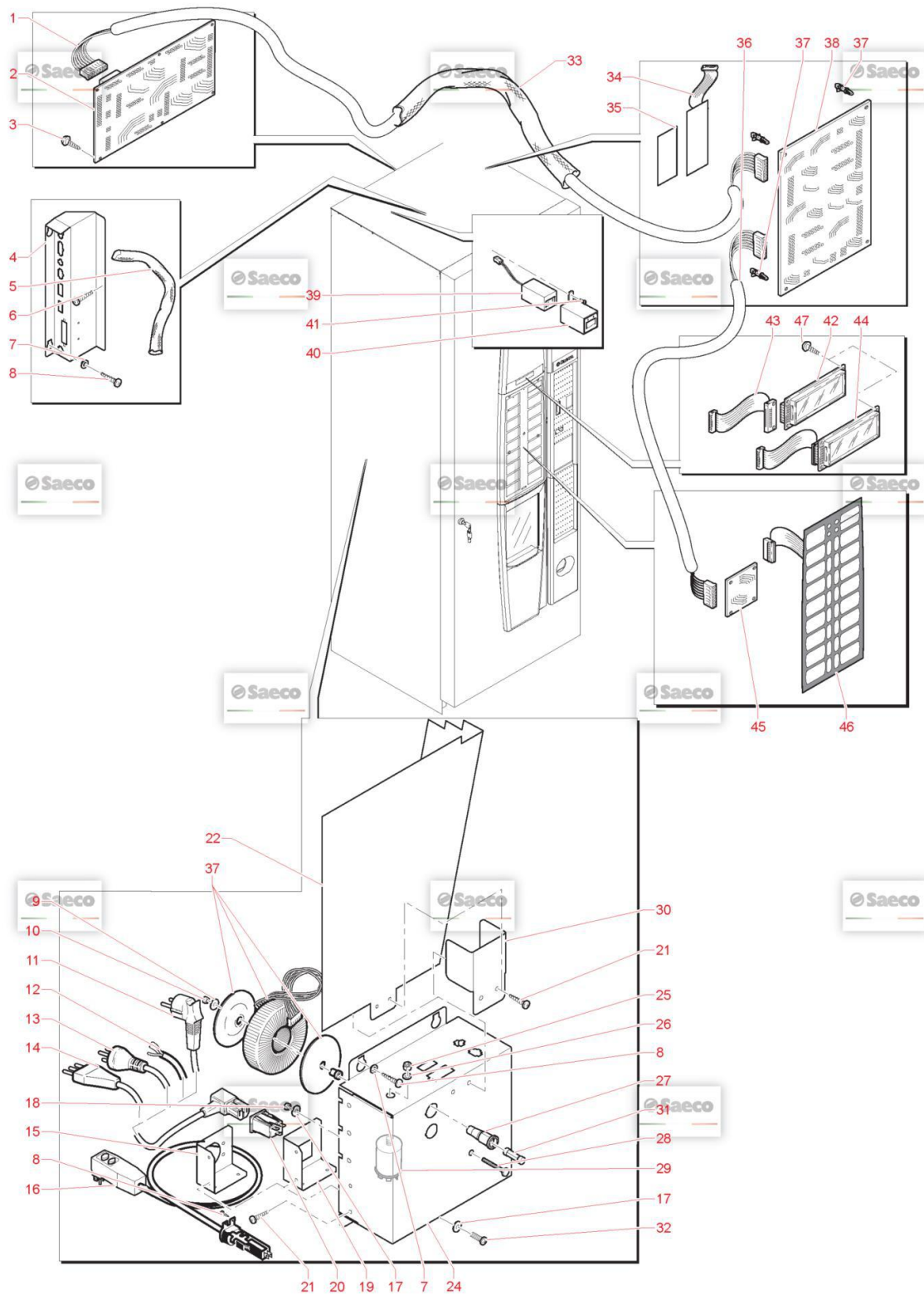

Model Machine

MACSAE113

SAECO CRISTALLO 600 ЧЁРНАЯ

Web Pos. Foto Item - Replace by Description



Press - CTRL + CLICK go to item in a new window

Натисніть - Ctrl + права кнопка миші щоб відкрити запчастину в новому вікні



1

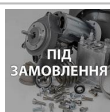

1863.603

FLAT CABLE
FLAT CABLE



2



1863.636

POWER CARD FS400
SCHEDA POWER FS400



3



U116.006

SCREW AUT.PT TCB 3,5X12 WN 1441 ZNP
VITE AUT.PT TCB 3,5X12 WN 1441 ZNP



4

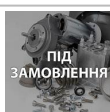

1863.070

BOX
BOX



5



11001619

CABLE TUBE L.520 MM
GUAINA X CAVI L.520 MM



6



U109.003

SCREW TCB 3,5X9,5 DIN 7981 C NICK
SCREW TCB 3,5X9,5 DIN 7981 C NICK



7

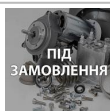

11011054

PIN FOR BOSS D.8
PIN FOR BOSS D.8



8



U110.005

SCREW AUT.TCB 3,9X9,5 DIN 7981F
VITE AUT.TCB 3,9X9,5 DIN 798



9

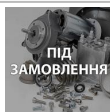

U207.013

PLAIN WASHER 6.5X18 UNI 6592 GALV
PLAIN WASHER 6.5X18 UNI 6592 GALV



10



U310.004

NUT SELF LOCK.M6 UNI 7473
NUT SELF LOCK.M6 UNI 7473



11



NE01.050

CABLE SCHUKO WITH PLUG EN60320C1
CAVO SCHUKO CON SPINA EN60320 C13



12

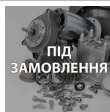

NE01.054

CABLE WITH PLUG EN60320 C13
CABLE WITH PLUG EN60320 C13



13

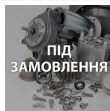











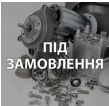

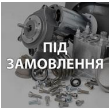













NE01.053

CABLE AUSTRAL. +PLUG EN60320 C13
CABLE AUSTRAL. +PLUG EN60320 C13

Model Machine

MACSAE113























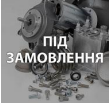

SAECO CRISTALLO 600 ЧЁРНАЯ

	13		NE01.093	CABLE ARGENTINA + PLUG EN60320C13 <i>CABLE ARGENTINA + PLUG EN60320 C13</i>
	14		NE01.051	CABLE SWITZERLAND WITH PLUG EN603 <i>CABLE SWITZERLAND WITH PLUG EN603</i>
	15		11003906	USA CABLE SUPPORT ELECTRONIC PARTS BOX <i>USA CABLE SUPPORT ELECTRONIC PARTS BOX</i>
	16		11008469	POWER CABLE USA 3 POLE 15A <i>POWER CABLE USA 3 POLE 15A</i>
	17		U208.003	TOOTHED WASHER 5,1X9 BRU <i>TOOTHED WASHER 5,1X9 BRU</i>
	18		U302.003	GALV.NUT HEXAGONAL M4 UNI 5589ZN <i>DADO ESAGONALE M4 UNI 5588 ZNP</i>
	19		11000546	POWER CONNECTOR SUPPORT <i>SQUADRETTA X PRESA VASCHETTA</i>
	20		187850400	TRIPOLE SOCKET SELF-LOCKING <i>TRIPOLE SOCKET SELF-LOCKING</i>
	21		U110.003	SCREW AUT.TCB 3,5X9,5 DIN 7981F <i>VITE AUT.TCB 3,5X9,5 DIN 798</i>
	22		11008601	HARNESS UL CARTER CRISTALLO600 <i>HARNESS UL CARTER CRISTALLO600</i>
	23		NE19.023	TOROIDAL TRANSFORMER COMBI 240V <i>TOROIDAL TRANSFORMER COMBI 240V</i>
	23		NE19.028	TOROIDAL TRANSFORMER FS 400 <i>TRASFORMATORE TOROIDALE FS 400</i>
	24		1863.045	ASPIRATION CASING FOR MIXER <i>ASPIRATION CASING FOR MIXER</i>
	25		U302.007	NUT HEXAGONAL M8 UNI 5588 <i>NUT HEXAGONAL M8 UNI 5588</i>

Model Machine

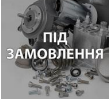
MACSAE113

























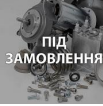

SAECO CRISTALLO 600 ЧЁРНАЯ

	26		U208.009	TOOTHED WASHER 8,4X15 UNI 3703 <i>TOOTHED WASHER 8,4X15 UNI 3703</i>
	27		NE13.016	FUSE HOLDER WITH SCREW ON CAP <i>PORTAFUSIBILE CON TAPPO A VITE</i>
	28		U005.013	SCREW TE M6,0X70 UNI 5739 GALV. <i>SCREW TE M6,0X70 UNI 5739 GALV.</i>
	29		12001353	МЕРЕЖЕВИЙ ФІЛЬТР 16А <i>LOCKING SCREW ANTIDISTURB FILTER 16A</i>
	30		11003867	SAFETY PLATE FOR EL.BOX CONNECTOR <i>SAFETY PLATE FOR EL.BOX CONNECTOR</i>
	31		NE13.002	FUSE 6,3X32 8A 250V DELAYED <i>FUSE 6,3X32 8A 250V DELAYED</i>
	31		NE13.081	FUSE 6,3X32 16A 250V DELAYED UL <i>FUSIBILE 6,3 X 32 15A 250V RITARD UL SOLO UL</i>
	32		12002039	SCREW TCBD TORX 20 M4X12 ZN-B <i>VITE TCBD TORX 20 M4X12 ZN-B</i>
	33		11003521	620MM CABLE TUBE <i>GUAINA X CAVI L.780MM</i>
	34		0875.741	TOUCH PANEL <i>TOUCH PANEL</i>
	35		0875.990	TOUCH PANEL PLATE <i>TOUCH PANEL PLATE</i>
	36		11005277	FLAT CABLE CONNECTING T.PANEL/CPU FS600 <i>FLAT CABLE COLL.TASTIERA CPU CRISTALLO 600</i>
	37		NF11.048	SPACER FOR CPU CARD <i>SPACER FOR CPU CARD</i>

Model Machine

MACSAE113

SAECO CRISTALLO 600 ЧЁРНАЯ

	38		11006822	CPU+SW AS.CRISTALLO600 <i>AS.CPU+SW CRISTALLO 600</i>
	38		11011825	CPU+SW AS.CRISTALLO600 TTT <i>CPU+SW AS.CRISTALLO600 TTT</i>
	38		11026055	CPU+SW AS CRISTALLO400/600 ESP/TTT <i>CPU+SW AS CRISTALLO400/600 ESP/TTT</i>
	39		NE13.025.00P	IMPULSE COUNTER KEISU GX-06R 24V <i>CONTAIMPULSI KEISU GX-06R 24</i>
	40		9991.140.050	IMPULSECOUNTERHOLDER KEISU GX-06R <i>PORTA CONTAIMPULSI KEISU GX-</i>
	41		U110.004	SCREW AUT.TCB 3,5X6,5 DIN 7981F <i>VITE AUT.TCB 3,5X6,5 DIN 7981 F NIK</i>
	42		11000299	DISPLAY FS400 GREY <i>DISPLAY FS400 GRIGIO</i>
	43		11005334	16 POLES FLAT CABLE FOR CRISTALLO600 <i>FLAT CABLE 16 POLI CRISTALLO 600</i>
	43		11021700	FLAT CABLE 16 POLES L.300MM <i>FLAT CABLE 16 POLES L.300MM</i>
	44		192200500	20X2 LCD BLUE DISPLAY STN + FLAT <i>20X2 LCD BLUE DISPLAY STN + FLAT</i>
	45		0875.651	TOUCH PANEL CONNECTION CARD <i>SCHEDINO COLLEGAMENTO TASTIE</i>
	46		11005282	SWITCH PUSHBUTTON BEIGE-RED <i>TASTIERA ADESIVA MEMBRANA ROSSO-BEIGE</i>
	46		11014219	SWITCH PUSHBUTTON GREY <i>SWITCH PUSHBUTTON GREY</i>
	46		11028016	SWITCH PUSHBUTTON GREY <i>SWITCH PUSHBUTTON GREY</i>

Model Machine

MACSAE113

SAECO CRISTALLO 600 ЧЁРНАЯ



46



11030948

SWITCH PUSHBUTTON GREY

TASTIERA ADES.MEMBR.CRISTALLO600 C.B.GRY



47



U116.005

SCREW AUT.PT TCB 3,0X8 WN 1441

VITE AUT.PT TCB 3,0X8 WN 1441 ZNP

Model Machine

MACSAE113

SAECO CRISTALLO 600 ЧЁРНАЯ

MACSAE113.T.0011



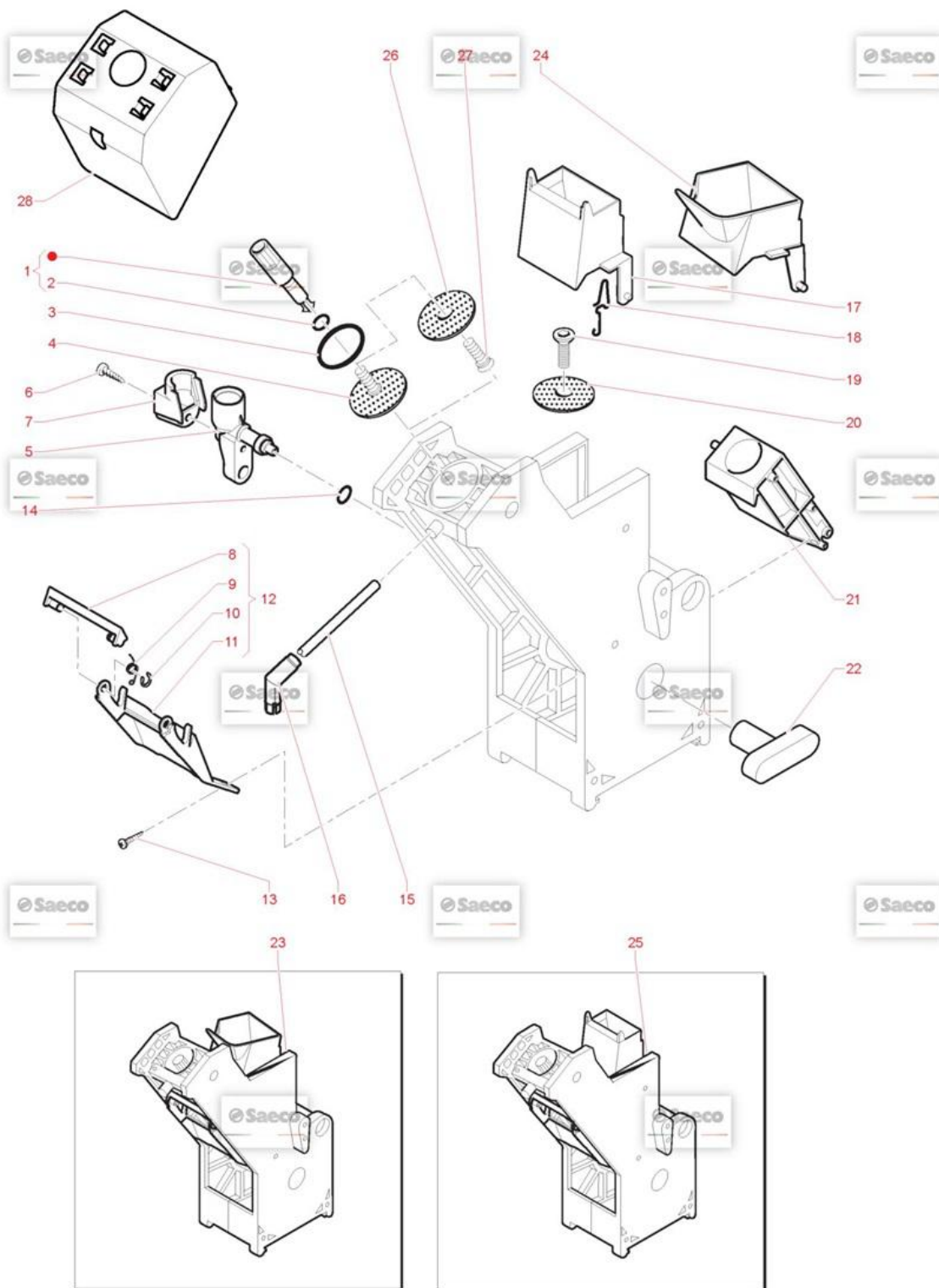























TAVOLA NR. 11 - ARTICOLO SAECO CRISTALLO 600 ЧЁРНАЯ



Model Machine

MACSAE113



























SAECO CRISTALLO 600 ЧЁРНАЯ

Web	Pos.	Foto	Item - Replace by	Description
				<i>Press - CTRL + CLICK go to item in a new window Натисніть - Ctrl + права кнопка миші щоб відкрити запчастину в новому вікні</i>
	1		9169.A14.060	ТРИМАЧ ФІЛЬТРА-СИТО РОБОЧОГО БЛОКУ КОРИЧНЕВИЙ КАВОМАШИН... <i>PIN FOR PERCOLATOR BROWN</i>
	2		NM02.006	OR R5 TERMOIL <i>OR R5 EPDM</i>
	3		140322061	O-RING 4112 EPDM <i>OR 4112 IN EPDM</i>
	4		324000100	SS PERCOLATOR D=34 SCREW FOR UNIT <i>SS PERCOLATOR D=34 SCREW FOR UNIT</i>
	5		11005371	UNIT COFFEE MUFF <i>MANICOTTO GRUPPO CAFFE' UNIT COFFEE MUFF</i>
	6		129512921	SCREW TCB TORX 10 AB 2,9X13 SHEET SS <i>SCREW TCB TORX 10 2,9X13 SHEET SS</i>
	7		11010013	CARTER FOR MUFF PREHEATING UNIT <i>CARTE X MANICOTTO GRUPPO PRERISCALDO</i>
	8		9111.537.060	BROWN SCRAPER COFFEE GROUP <i>BROWN SCRAPER COFFEE GROUP</i>
	9		9111.520	SPRING FOR SCRAPER SECTION 0.6 <i>SPRING FOR SCRAPER SECTION 0.6</i>
	10		U701.006	SNAP RING 3,2 UNI 7434 <i>ANELLO ELASTICO 3,2</i>
	11		9111.539.060	FORK FOR SCRAPER <i>FORCELLA PER RASCHIATORE</i>
	12		9110.067.060	SCRAPER ASS.FOR CAPPUCCINAT. TUBE <i>ASS.RASCHIATORE X SG500/700</i>
	13		U110.013	SCREW AUT.TCB 3,9X6,5 DIN 7981F <i>SCREW AUT.TCB 3,9X6,5 DIN 7981 F</i>

Model Machine

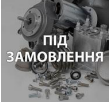
MACSAE113

SAECO CRISTALLO 600 ЧЁРНАЯ

	14		140321462	O-RING 2018 SILICONE <i>OR 2018 IN SILICONE</i>
	15		9972.057	КОРИЧНЕВА ГУМОВА ТРУБКА 5X8 2 МЕТРИ <i>TUBO SILICONE MARRON 5X8 L.2000 MM</i>
	16		9111.349	ELBOW DISPENSING NOZZLE <i>UGELLO EROGAZIONE GOMITO</i>
	17		322001201	MOBILE SCRAPER BROWN NARROW <i>MOBILE SCRAPER BROWN NARROW</i>
	18		9161.425	SPRING FOR SCRAPER <i>SPRING FOR SCRAPER</i>
	19		129851921	TSP SCREW M3X6 UNI 7688 SS <i>TSP SCREW M3X6 UNI 7688 SS</i>
	20	 ПІД ЗАМОВЛЕННЯ	324000200	SS PERCOLATOR D=34 FOR UNIT <i>SS PERCOLATOR D=34 FOR UNIT</i>
	21		222711101	BROWN GROUND COFF.CONTAINER D=36 ASSY. <i>BROWN GROUND COFF.CONTAINER D=36 ASSY.</i>
	22		9161.021.060	KEY FOR BREW UNIT BROWN <i>CHIAVE X GRUPPO CAFFE' MARRO</i>
	23	 ПІД ЗАМОВЛЕННЯ	11021839	BREW UNIT 7 GRAMS CRISTALLO600DUO <i>BREW UNIT 7 GRAMS CRISTALLO600DUO</i>
	24		11003529	HOPPER DOSER UNIT FRESH BREW <i>HOPPER DOSER UNIT FRESH BREW</i>
	25	 ПІД ЗАМОВЛЕННЯ	11005421	BREW UNIT 7 GRAMS CRISTALLO600 <i>GRUPPO CAFFE' 7GR CRISTALLO600</i>
	25		11023330	BREW UNIT 7 GRAMS <i>BREW UNIT 7 GRAMS CRISTALLO600</i>
	26		11012630	PERCOLATOR D.34 <i>PERCOLATOR D.34</i>

Model Machine

MACSAE113

SAECO CRISTALLO 600 ЧЁРНАЯ



27



129852821

TSP SCREW M3X14 UNI 7688 SS

TSP SCREW M3X14 UNI 7688 SS



28



11013053

CARTER FOR DOSER UNIT

CARTER FOR DOSER UNIT

Model Machine

MACSAE113

SAECO CRISTALLO 600 ЧЁРНАЯ

MACSAE113.T.0012

TAVOLA NR. 12 - ARTICOLO SAECO CRISTALLO 600 ЧЁРНАЯ

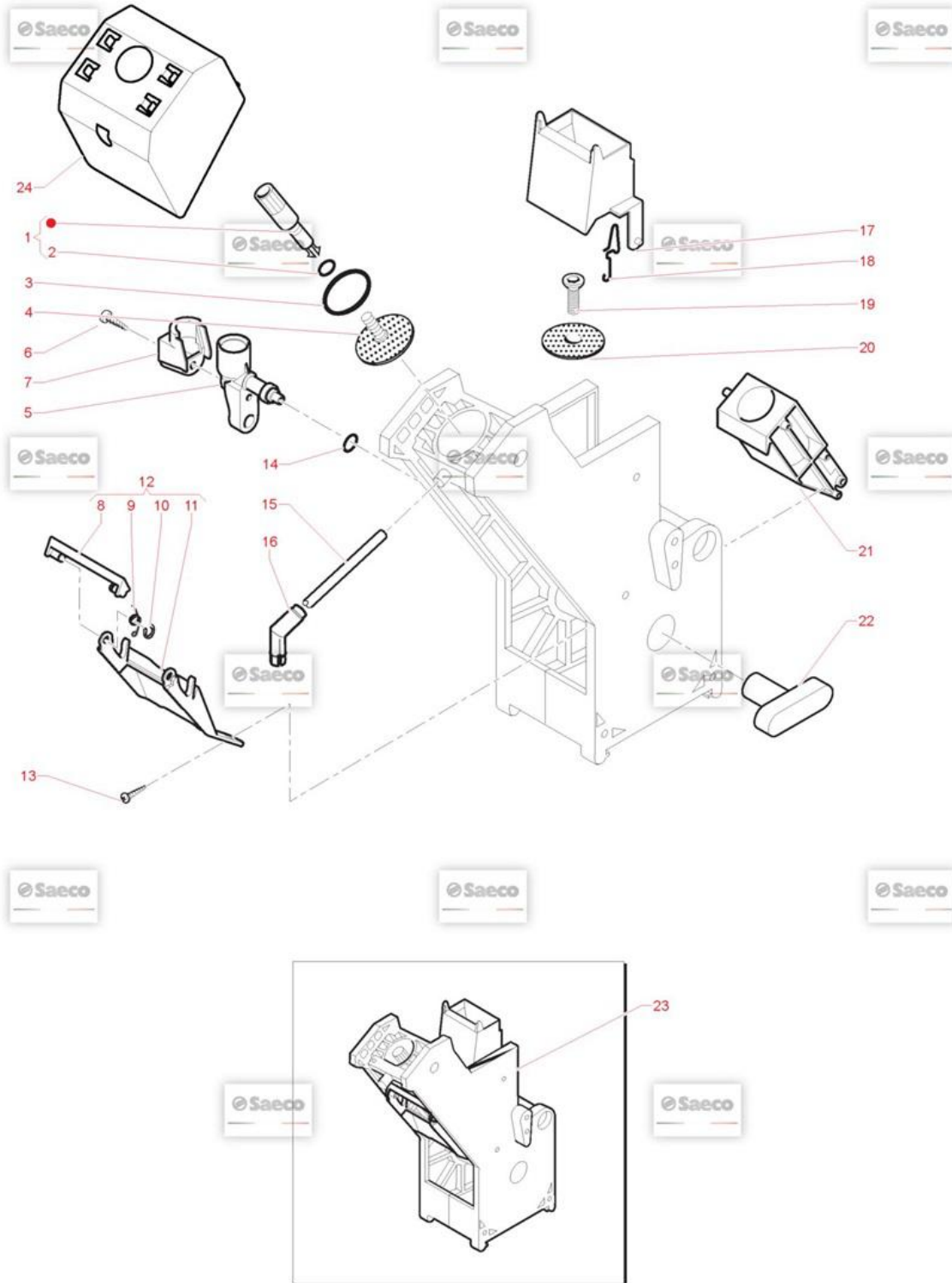

Model Machine

MACSAE113

SAECO CRISTALLO 600 ЧЁРНАЯ

Web Pos. Foto Item - Replace by Description



Press - CTRL + CLICK go to item in a new window
Натисніть - Ctrl + права кнопка миші щоб відкрити запчастину в новому вікні



1



9169.A14.150

PIN FOR PERCOLATOR GREY
ASS.PERNO X DOCCIA COMPLETO GRIGIO



2



NM02.006

OR R5 TERMOIL
OR R5 EPDM



3

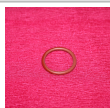

NM01.044

OR ORM 0320-40 SILICONE PTFE/FDA
OR ORM 0320-40 SILICONE PTFE



4



9161.036

UPPER PERCOLATOR FOR UNIT
DOCCIA SUPERIORE X GRUPPO



5



11005371

UNIT COFFEE MUFF
MANICOTTO GRUPPO CAFFE' UNIT COFFEE MUFF



6



129512921

SCREW TCB TORX 10 AB 2,9X13 SHEET SS
SCREW TCB TORX 10 2,9X13 SHEET SS



7



11010013

CARTER FOR MUFF PREHEATING UNIT
CARTE X MANICOTTO GRUPPO PRERISCALDO



8



9111.537.150

GREY SCRAPER COFFEE GROUP
GREY SCRAPER COFFEE GROUP



9



9111.520

SPRING FOR SCRAPER SECTION 0.6
SPRING FOR SCRAPER SECTION 0.6



10



U701.006

SNAP RING 3,2 UNI 7434
ANELLO ELASTICO 3,2



11



9111.539.150

FORK FOR SCRAPER
FORCELLA PER RASCHIATORE



12



9110.067.150

SCRAPER ASS.FOR CAPPUCCIAT. TUBE
ASS.RASCHIATORE X SG500/700



13

























U110.013

SCREW AUT.TCB 3,9X6,5 DIN 7981F
SCREW AUT.TCB 3,9X6,5 DIN 7981 F

Model Machine

MACSAE113

SAECO CRISTALLO 600 ЧЁРНАЯ

	14		140321462	O-RING 2018 SILICONE <i>OR 2018 IN SILICONE</i>
	15		9972.057	КОРИЧНЕВА ГУМОВА ТРУБКА 5X8 2 МЕТРИ <i>TUBO SILICONE MARRON 5X8 L.2000 MM</i>
	16		9111.349	ELBOW DISPENSING NOZZLE <i>UGELLO EROGAZIONE GOMITO</i>
	17		322001259	ПЛАСТИКОВА ВОРНОКА ПОДАЧИ КАВИ (ПЛАСТИК) ЧОРНИЙ <i>MOBILE SCRAPER GREY NARROW</i>
	18		9161.425	SPRING FOR SCRAPER <i>SPRING FOR SCRAPER</i>
	19		129851921	TSP SCREW M3X6 UNI 7688 SS <i>TSP SCREW M3X6 UNI 7688 SS</i>
	20		9161.037	LOWER PERCOLATOR FOR UNIT <i>DOCCIA INFERIORE X GRUPPO</i>
	21		11002626	ASS. COFFEE CONTAINER GREY 9 GR. <i>ASS. COFFEE CONTAINER GREY 9 GR.</i>
	22		9161.021.060	KEY FOR BREW UNIT BROWN <i>CHIAVE X GRUPPO CAFFE' MARRO</i>
	23		11005422	BREW UNIT 9 GRAMS <i>GRUPPO CAFFE' 9GR CRISTALLO 600</i>
	24		11013053	CARTER FOR DOSER UNIT <i>CARTER FOR DOSER UNIT</i>

Model Machine

MACSAE113

SAECO CRISTALLO 600 ЧЁРНАЯ

MACSAE113.T.0013



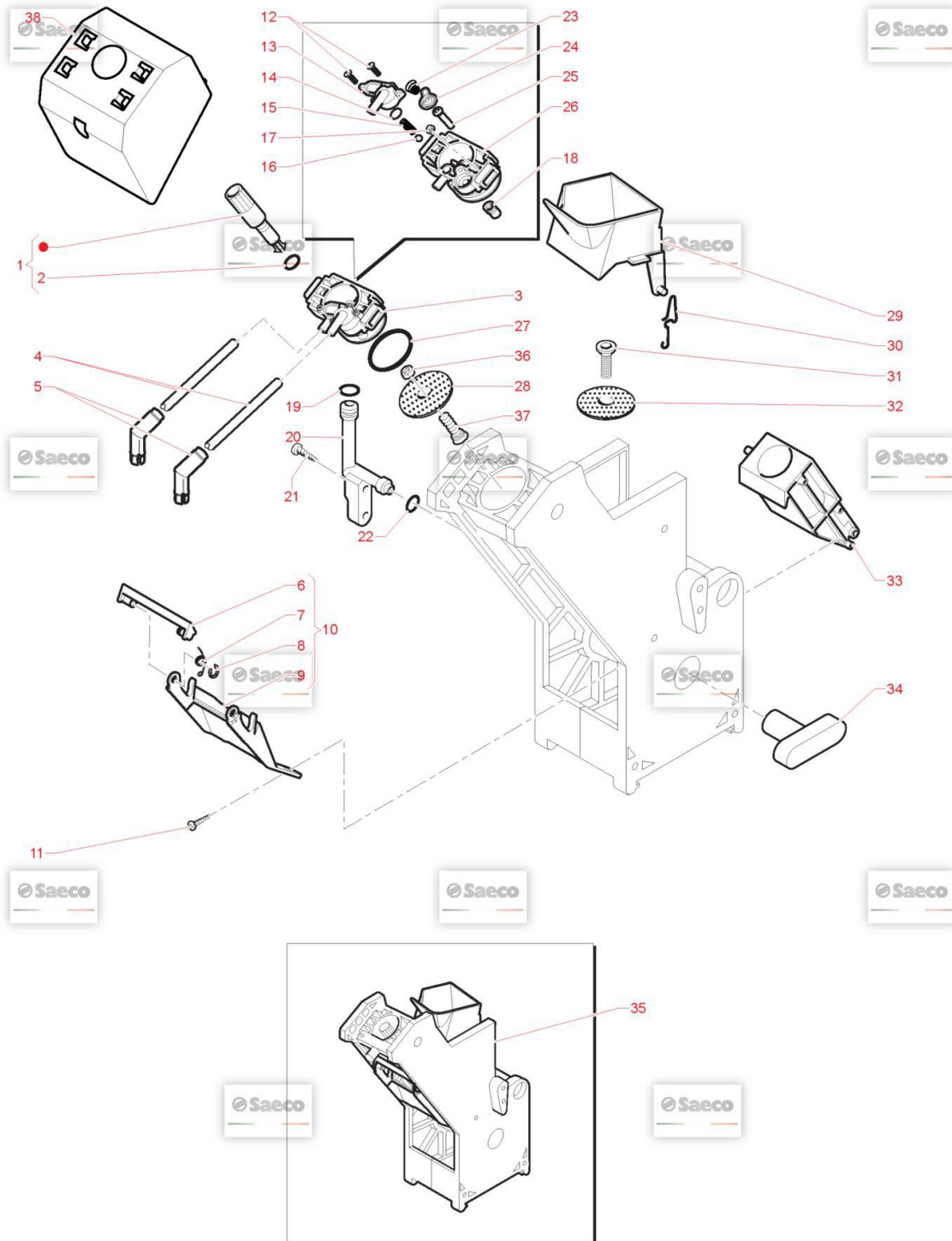























TAVOLA NR. 13 - ARTICOLO SAECO CRISTALLO 600 ЧЁРНАЯ



Model Machine

MACSAE113

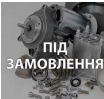









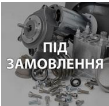















SAECO CRISTALLO 600 ЧЁРНАЯ

Web	Pos.	Foto	Item - Replace by	Description
				<i>Press - CTRL + CLICK go to item in a new window Натисніть - Ctrl + права кнопка миші щоб відкрити запчастину в новому вікні</i>
	1		9169.A14.150	PIN FOR PERCOLATOR GREY ASS.PERNO X DOCCIA COMPLETO GRIGIO
	2		NM02.006	OR R5 TERMOIL OR R5 EPDM
	3		11007343	ASS.COUNTERPISTON FRESH-BREW ASS.COUNTERPISTON FRESH-BREW
	4		9972.057	КОРИЧНЕВА ГУМОВА ТРУБКА 5X8 2 МЕТРИ TUBO SILICONE MARRON 5X8 L.2000 MM
	5		9111.349	ELBOW DISPENSING NOZZLE UGELLO EROGAZIONE GOMITO
	6		9111.537.150	GREY SCRAPER COFFEE GROUP GREY SCRAPER COFFEE GROUP
	7		9111.520	SPRING FOR SCRAPER SECTION 0.6 SPRING FOR SCRAPER SECTION 0.6
	8		U701.006	SNAP RING 3,2 UNI 7434 ANELLO ELASTICO 3,2
	9		9111.539.150	FORK FOR SCRAPER FORCELLA PER RASCHIATORE
	10		9110.067.150	SCRAPER ASS.FOR CAPPUCCINAT. TUBE ASS.RASCHIATORE X SG500/700
	11		U110.013	SCREW AUT.TCB 3,9X6,5 DIN 7981F SCREW AUT.TCB 3,9X6,5 DIN 7981 F
	12	 ПІД ЗАМОВЛЕННЯ	U109.030	CAMOP13 AUT.TCB 2,9X16 DIN 7981 C SCREW AUT.TCB 2,9X16 DIN 7981 C
	13		11003470	КРИШКА НОСИКА LID X COUNTERPISTON FRESH-BREW

Model Machine

MACSAE113



















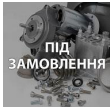

SAECO CRISTALLO 600 ЧЁРНАЯ

	14		NM02.013	OR ORM 0080-15 TERMOIL <i>OR ORM 0080-15 TERMOIL</i>
	15		11028830	ПРУЖИНКА ДЛЯ FS400 ПІД ШАРИК ПОРШНЯ <i>SPRING FOR FS400 COVER CHASSIS</i>
	16		9991.168	GLASS SPHERE D.5 MM <i>SFERA IN VETRO D.5 MM</i>
	17		U302.003	GALV.NUT HEXAGONAL M4 UNI 5589ZN <i>DADO ESAGONALE M4 UNI 5588 ZNP</i>
	18		11003472	RUBBER X UNIT FRESH-BREW <i>RUBBER X UNIT FRESH-BREW</i>
	19		140320461	OR ORM 0080-20 TERMOIL <i>OR ORM 0080-20 IN TERMOIL</i>
	20		322000559	WATER FLOW PISTON GREY <i>WATER FLOW PISTON GREY</i>
	21		129512921	SCREW TCB TORX 10 AB 2,9X13 SHEET SS <i>SCREW TCB TORX 10 2,9X13 SHEET SS</i>
	22		140321462	O-RING 2018 SILICONE <i>OR 2018 IN SILICONE</i>
	23		11002603	SPING FOR MEMBRANE <i>SPING FOR MEMBRANE</i>
	24		11002625	MEMBRANE <i>MEMBRANE</i>
	25		11003471	PIN FOR MEMBRANE FRESH-BREW <i>PIN FOR MEMBRANE FRESH-BREW</i>
	26		11003469	COUNTERPISTON FRESH-BREW <i>COUNTERPISTON FRESH-BREW</i>
	27		NM01.044	OR ORM 0320-40 SILICONE PTFE/FDA <i>OR ORM 0320-40 SILICONE PTFE</i>

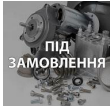
Model Machine

MACSAE113

SAECO CRISTALLO 600 ЧЁРНАЯ



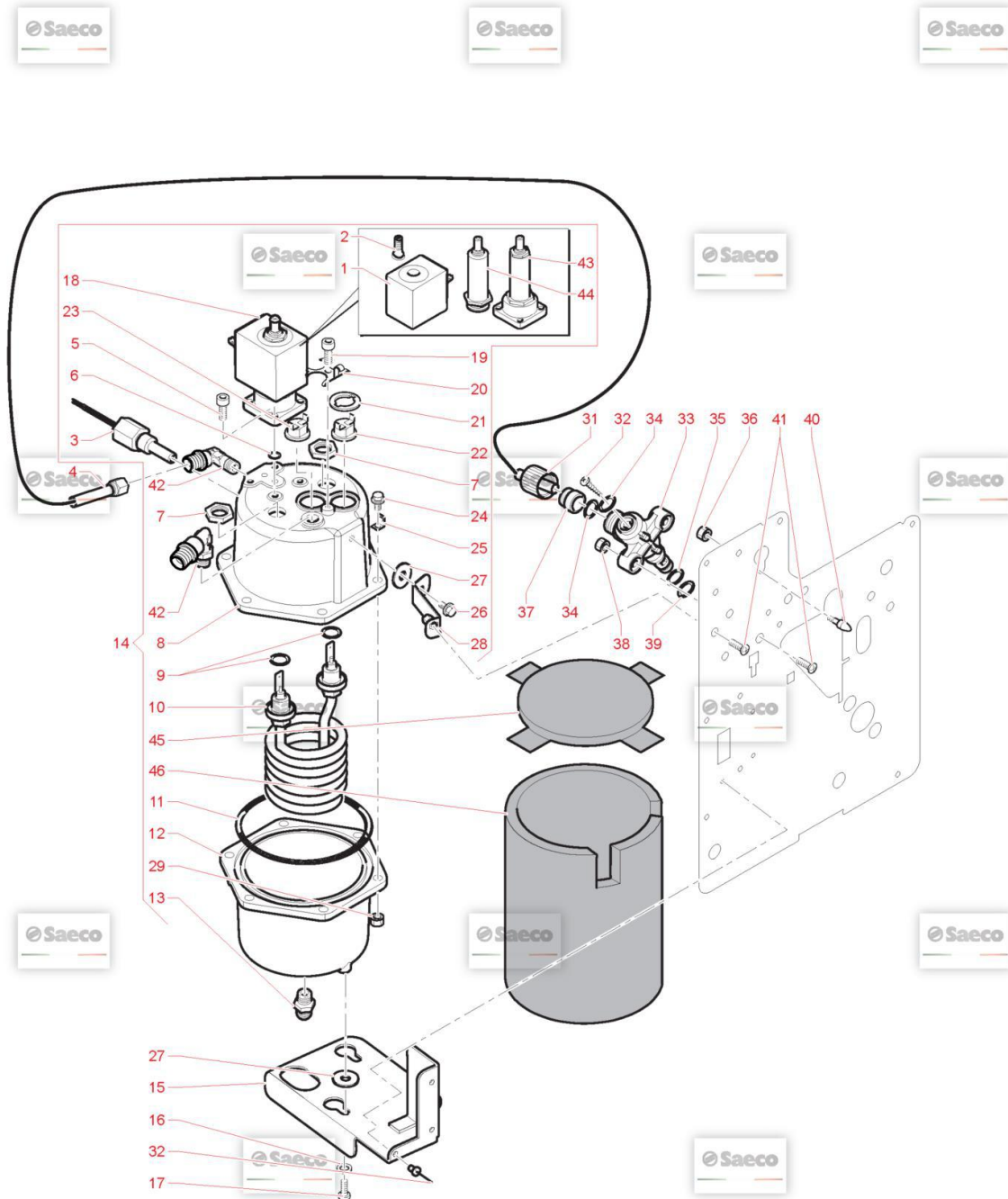



















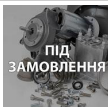

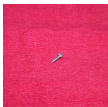

	28		9161.167	СИТО МЕТАЛЛЕВЕ D=35,8 SAECO 11008362 <i>PERCOLATOR D.35,8</i>
	29		11003529	HOPPER DOSER UNIT FRESH BREW <i>HOPPER DOSER UNIT FRESH BREW</i>
	30		126836618	SPRING H=28 NEW FOR SCRAPER <i>MOLLA H=28 NEW X RASCHIATORE</i>
	31		129851921	TSP SCREW M3X6 UNI 7688 SS <i>TSP SCREW M3X6 UNI 7688 SS</i>
	32		9161.037	LOWER PERCOLATOR FOR UNIT <i>DOCCIA INFERIORE X GRUPPO</i>
	33		11002626	ASS. COFFEE CONTAINER GREY 9 GR. <i>ASS. COFFEE CONTAINER GREY 9 GR.</i>
	34		9161.021.150	KEY FOR BREW UNIT GREY <i>KEY FOR BREW UNIT GREY</i>
	35		11007283	BREW UNIT 10GRAMS FRESH BREW <i>BREW UNIT 10GRAMS FRESH BREW</i>
	36		U301.003	ГАЙКА HEXAGONAL M3 UNI 5587 <i>NUT HEXAGONAL M3 UNI 5587</i>
	37		129852821	TSP SCREW M3X14 UNI 7688 SS <i>TSP SCREW M3X14 UNI 7688 SS</i>
	38		11013053	CARTER FOR DOSER UNIT <i>CARTER FOR DOSER UNIT</i>

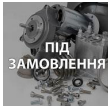

Model Machine

MACSAE113





























SAECO CRISTALLO 600 ЧЁРНАЯ

Web	Pos.	Foto	Item - Replace by	Description
				<i>Press - CTRL + CLICK go to item in a new window Натисніть - Ctrl + права кнопка миші щоб відкрити запчастину в новому вікні</i>
	1		20006583	COIL EVT HS2 11012534 COIL 11005360 11006877 11012534/533
	1		20007361	SOLENOID EVT ODE SOLENOID EVT ODE
	2		20006974	MOBILE NUCLEUS OLAB 8000-836 MOBILE NUCLEUS OLAB 8000-836
	2		20007362	SPARE CORE EV ODE RIC. NUCLEO EVT ODE
	3		11005368	IMMERSION PROBE ASS. ASS.SONDA TEMPER.AD.IMMERSIONE
	4		11025409	TUBE ASSEMBLY TEFLON 3X6 L.220MM TUBE ASSEMBLY TEFLON 3X6 L.220MM
	5		12001179	SCREW TCEI M4,0X12 UNI 5931 8.8 ZIN. SCREW TCEI M4,0X12 UNI 5931 8.8 ZIN.
	6		20007312	SPARE OR EVT HS2 11012534 SPARE OR EVT HS2 11012534
	7		9991.029	NUT FOR RESISTOR DADO X RESISTENZA
	8		11012528	UPPER CASING BOILER 600CC TEA UPPER CASING BOILER 600CC TEA
	9		11000972	OR 3050 FKM 80 FD PEROXIDICA OR 3050 FKM 80 FD PEROXIDICA
	10		11005367	HEAT ELEMENT BOILER 230V 1550W HEAT ELEMENT BOILER 230V 1550W
	11		12000770	OR ORM 4350 VITON OR METRICO 4350 IN VITON

Model Machine

MACSAE113















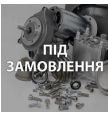



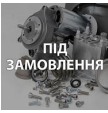





SAECO CRISTALLO 600 ЧЁРНАЯ

	12		11012529	LOWER CASING BOILER 600CC TEA <i>LOWER CASING BOILER 600CC TEA</i>
	13		11027089	WATER INLET CONNECTOR <i>WATER INLET CONNECTOR</i>
	14		11025321	BOILER 600CC 230/50 TEA <i>BOILER ASS.CRISTALLO600 600CC 230/50 TEA</i>
	15		11008090	SUPPORT PLATE BOILER 600CC <i>SUPPORT PLATE BOILER 600CC</i>
	16		U207.001	PLAIN WASHER 5,3X10 UNI 6592 GAL <i>ROSETTA PIANA 5,3X10 UNI 6</i>
	17		U005.011	SCREW TE M4,0X10 UNI 5739 GALV. <i>SCREW TE M4,0X10 UNI 5739 GALV.</i>
	18		11012534	TEA ELECTROVALVE 2/3 WAY N.C. <i>TEA ELECTROVALVE 2/3 WAY N.C.</i>
	19		12001052	SCREW TCEI M4,0X6 DIN 912 ZIN <i>SCREW TCEI M4,0X6 DIN 912 ZIN</i>
	20		226760100	RETAINING SPRING 3 THERMOSTATS <i>RETAINING SPRING 3 THERMOSTATS</i>
	21		9991.085	THERMOSTAT FIXING WASHER <i>RONDELLA FERMATERMOSTATI</i>
	22		NE09.021	THERMOSTAT 150°NC FASTON 90° <i>TERMOSTATO 150°NC FASTON 90°</i>
	23		189428700	THERMOSTAT 175° 1NT-15L-5126 <i>THERMOSTAT 175° 1NT-15L-5126</i>
	24		U023.020	SCREW TCEI M6X20 UNI 5931 ZIN <i>VITE TCEI M6X20 UNI 5931 8.8</i>
	25		NE15.031	MALE TONGUE PLAIN 6,3 D.6,3 <i>MALE TONGUE PLAIN 6,3 D.6,3</i>

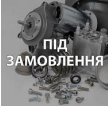
Model Machine

MACSAE113











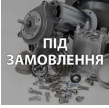

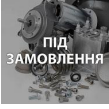



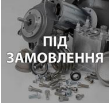

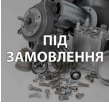
SAECO CRISTALLO 600 ЧЕРНАЯ

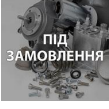
	26		U046.005	SCREW TE M5,0X10 WITH WASHER SCREW TE M5,0X10 WITH WASHER
	27		9111.501	INSULATION WASHER INSULATION WASHER
	28		11008063	BOILER 600CC SUPPORT CRISTALLO600 SUPPORTO CALDAIA 600CC CRISTALLO600
	29		U302.004	NUT HEXAGONAL M6 UNI 5588 DADO ESAGONALE M6 UNI 5
	30		NF11.115	BLIND RIVETS BLIND RIVETS
	31		11005743	KNURLED FEMALE HAND BOLT M14 GODRONE FEMMINA M14
	32		U109.037	SCREW AUT.TCB 4,8X13 DIN 7981C VITE AUT.TCB 4,8X13 DIN 7981 C NIK
	33		11005370	PIN FOR MUFF PERNO X MANICOTTO PIN FOR MUFF
	34		140321462	O-RING 2018 SILICONE OR 2018 IN SILICONE
	35		11013173	OR ORM 0090-20 FKM 80 FD GREENPEROXIDA OR ORM 0090-20 FKM 80 FD GREEN PEROXIDA
	36		U302.001	NUT HEXAGONAL M5 UNI 5588 DADO ESAGONALE M5 UNI 5
	37		11005741	CONNECTOR D.6 BOCCOLA ESTERNA D.6
	38		U302.003	GALV.NUT HEXAGONAL M4 UNI 5589ZN DADO ESAGONALE M4 UNI 5588 ZNP

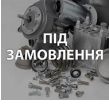
Model Machine

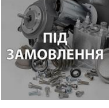
MACSAE113

SAECO CRISTALLO 600 ЧЁРНАЯ

	39		11013174	OR ORM 0050-20 FKM 80 FD GREENPEROXIDA <i>OR ORM 0050-20 FKM 80 FD GREEN PEROXIDA</i>
	40		11006046	PEG FOR BOILER <i>PEG FOR BOILER</i>
	41		U044.013	SCREW TSPC M4,0X12 UNI 7688 GALV. <i>VITE TSPC M4,0X12 UNI 7688 ZNP</i>
	42		12001181	BICONICAL CONNECT. L M 1/8X06TEA <i>BICONICAL CONNECT. L M 1/8X06 TEA</i>
	43		20007311	SPARE EVT HS2 11012534 <i>SPARE EVT HS2 11012534</i>
	43		20007370	SPARE EVT 11012534 <i>SPARE EVT 11012534</i>
	44		20007310	SPARE EVT HS2 11012534 <i>SPARE EVT HS2 11012534</i>
	44		20007363	SPARE EVT ODE <i>SPARE EVT ODE</i>
	45		11030776	COFFEE BOILER 600CC UPPER ISOLATOR <i>ISOLANTE SUP.CALDAIA 600CC VENDING</i>
	46		11030778	COFFEE BOILER 600CC UPPER ISOLATOR <i>ISOLANTE PERIMETR.CALDAIA 600CC VENDING</i>

Model Machine

MACSAE113

SAECO CRISTALLO 600 ЧЁРНАЯ

MACSAE113.T.0015



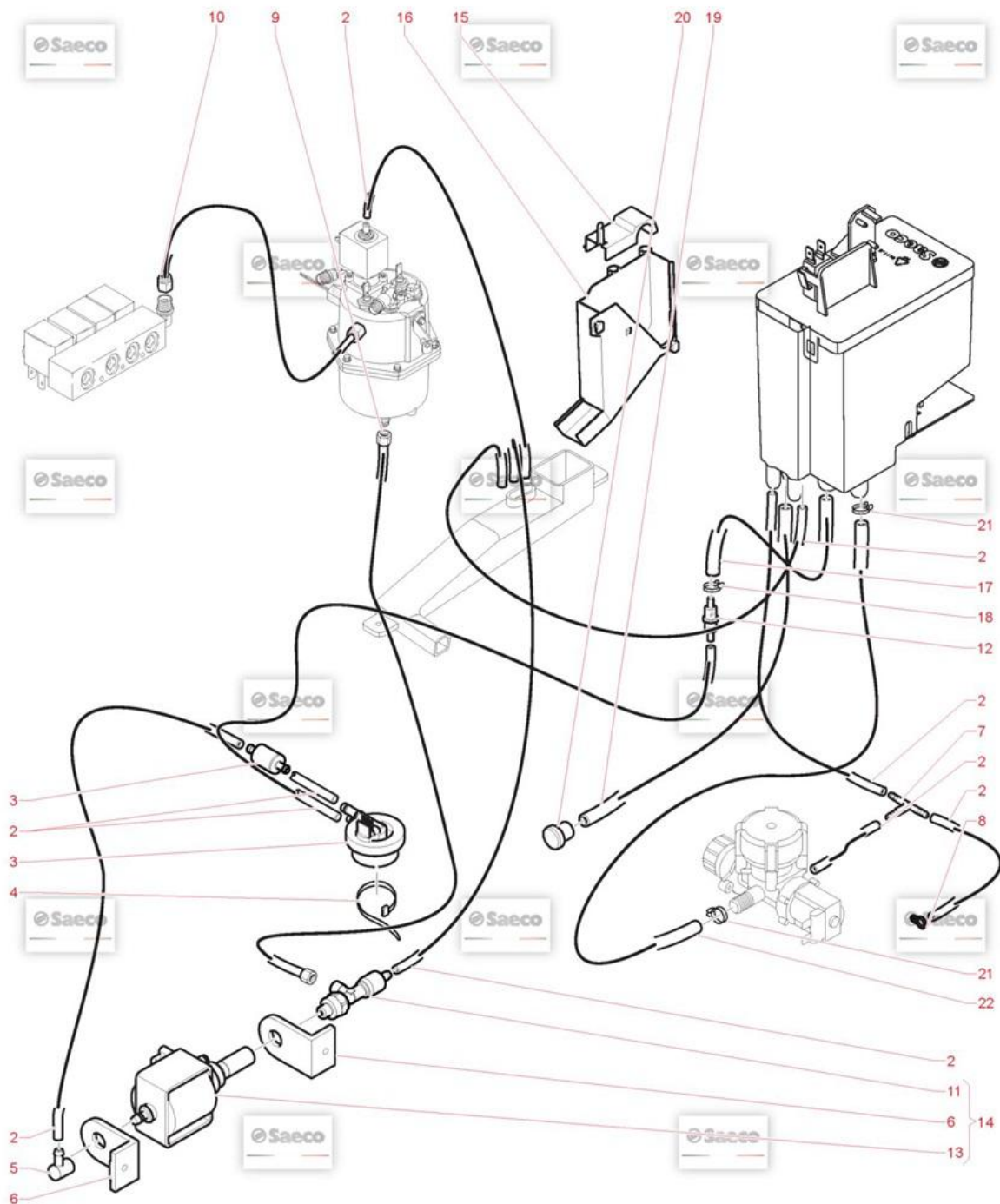









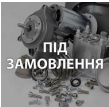













TAVOLA NR. 15 - ARTICOLO SAECO CRISTALLO 600 ЧЁРНАЯ



Model Machine

MACSAE113











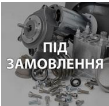





SAECO CRISTALLO 600 ЧЁРНАЯ

Web	Pos.	Foto	Item - Replace by	Description
				<i>Press - CTRL + CLICK go to item in a new window Натисніть - Ctrl + права кнопка миші щоб відкрити запчастину в новому вікні</i>
	1		11024178	WATER FILTER PHEDRA WATER FILTER PHEDRA
	2		9972.057	КОРИЧНЕВА ГУМОВА ТРУБКА 5X8 2 МЕТРИ TUBO SILICONE MARRON 5X8 L.2000 MM
	3		NV99.099	TURBINE D=1,2 ASSY. TURBINA DIGMESA FHKSC 1,2 ARNITE OC
	4		144320200	SELF LOCK STRIP W=2.6 L=200 SELF LOCK STRIP W=2.6 L=200
	5		147920150	90° INLET PUMP CONNECTOR RACCORDO A 90° IN SANTOPRENE
	6		149185850	ТРИМАЧ (ГУМОВИЙ)ПОМПИ ДЛЯ КАВОМАШИН SAECO MAGIC 4002012 (...) SUPPORTO POMPA EATON MAGIC 4
	7		NV99.004	CONNECTOR T MORONI 8026047 D=8 CONNECTOR T MORONI 8026047 D=8
	8		9111.141	DISCHARGE TUBE CLOSURE SPRING DISCHARGE TUBE CLOSURE SPRING
	9		11025297	TEFLON TUBE 3X6 L.310 1/8"-1/8 TEFLON TUBE 3X6 L.310 1/8"-1/8
	10		11025292	TEFLON TUBE 3X6 L.230 1/8"-1/8 TEFLON TUBE 3X6 L.230 1/8"-1/8
	11		11005590	SAFETY VALVE/NON RETURN ASS. NEW ASS.VALVOLA SICUREZZA/NON RI
	12		144650300	ФІЛЬТР ОЧИСТКИ ВОДИ ДЛЯ КАВОМАШИНИ SAECO NEW (NV99.001) (88...) ASPIRATION FILTER GAUZE NET 500 (NEW)
	13		9070.042.00A	ULKA НАСОС (ПОМПА) EX5GW 230/240V 50HZ SD1 БЪЯНКО 15 BAR ULKA PUMP EX5 SD1

Model Machine

MACSAE113

SAECO CRISTALLO 600 ЧЁРНАЯ

	14	 ПІД ЗАМОВЛЕННЯ	9070.043.00A	ULKA PUMP+NON RETURN <i>ULKA PUMP EX5 SD1 +NON RETURN</i>
	15		9161.262.060	DRIP CHANNEL COVER <i>COPERTURA CANALINO RACCOGLIGOCCE</i>
	16		9111.597.050	COFFEE DISCHARGE CHANNEL SHORT <i>CANALINO SCARICO CAFFE' CORTO</i>
	17	 ПІД ЗАМОВЛЕННЯ	9972.141	SILICONE TUBE 7X11 L.160MM <i>SILICONE TUBE 7X11 L.160 MM</i>
	18		NV99.072	HOSE CLAMP D. 11.6/12.3 <i>HOSE CLAMP D. 11.6/12.3</i>
	19		9972.335	SILICONE TUBE 7X11 L.135MM <i>TUBO SILICONE 7X11 L.1240 MM</i>
	20		NV03.006	CAP KAPSTO LPN 615/010 <i>TAPPO KAPSTO LPN 615/010</i>
	21		NV99.050	HOSECLAMP D. 13.3/14.1 <i>HOSECLAMP D. 13.3/14.1</i>
	22	 ПІД ЗАМОВЛЕННЯ	9972.134	SILICONE TUBE 7X11 L.850MM <i>SILICONE TUBE 7X11 L.850 MM</i>

Model Machine

MACSAE113

SAECO CRISTALLO 600 ЧЁРНАЯ

MACSAE113.T.0016

TAVOLA NR. 16 - ARTICOLO SAECO CRISTALLO 600 ЧЁРНАЯ

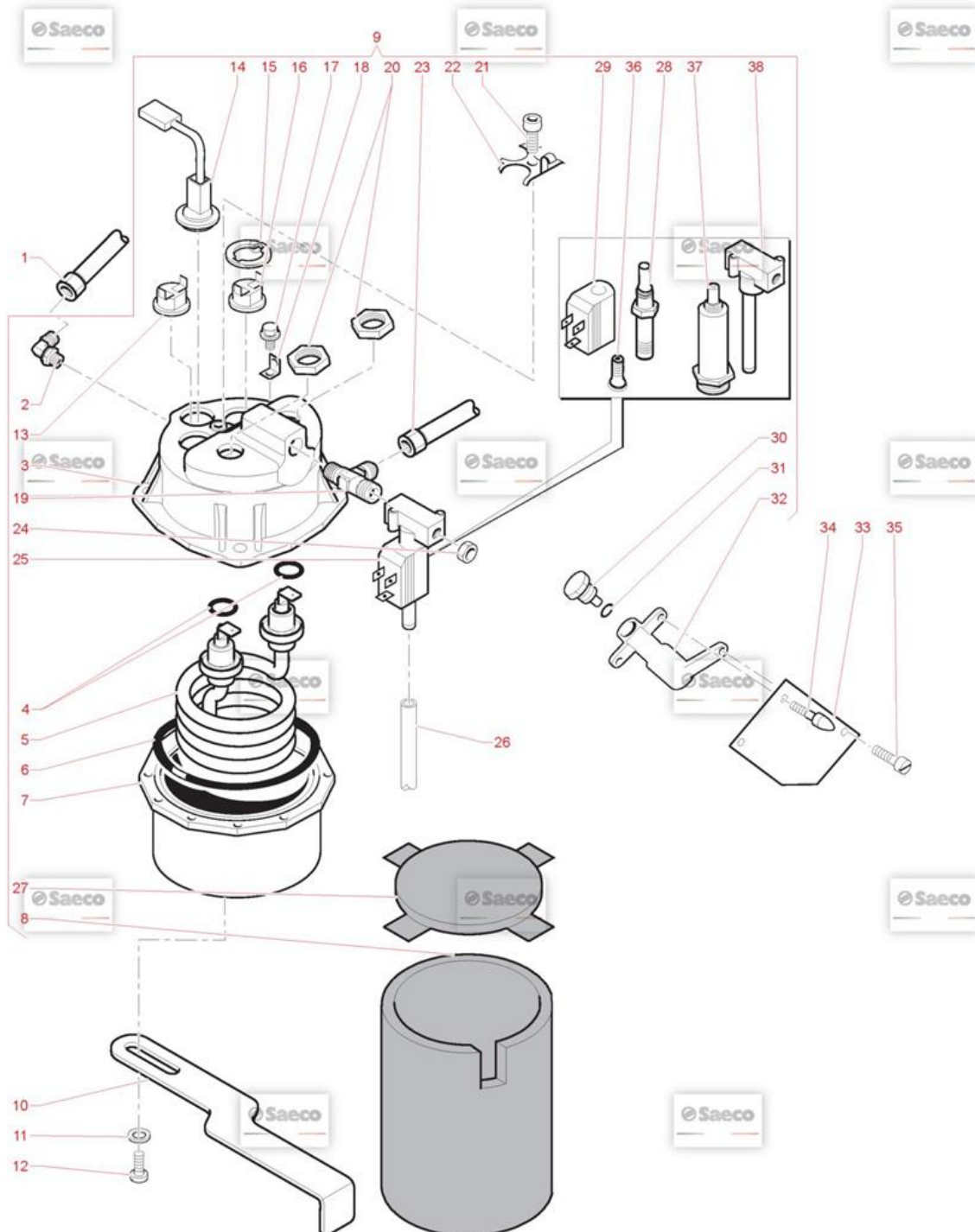

Model Machine

MACSAE113

SAECO CRISTALLO 600 ЧЁРНАЯ

Web Pos. Foto Item - Replace by Description



Press - CTRL + CLICK go to item in a new window

Натисніть - Ctrl + права кнопка миші щоб відкрити запчастину в новому вікні



1

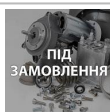

11025297

TEFLON TUBE 3X6 L.310 1/8"-1/8
TEFLON TUBE 3X6 L.310 1/8"-1/8



2

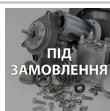

12001181

BICONICAL CONNECT. L M 1/8X06TEA
BICONICAL CONNECT. L M 1/8X06 TEA



3



11002259

UPPER DOSER CASING M6 TEA
UPPER DOSER CASING M6 TEA



4

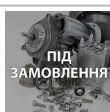

11000972

OR 3050 FKM 80 FD PEROXIDICA
OR 3050 FKM 80 FD PEROXIDICA



5



11007593

RES CALD. V120 W1000 INC.800
RES CALD. V120 W1000 INC.800



5

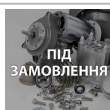

9011.255.00A

RES CALD.V230 W1000
RES.CALD. 230V 1000W



6



NM04.010

OR ORM 0730-40 FPM 70+-5 IRHDBLACK
OR ORM 0730-40 FPM 70 +-5 IRHD NERO



7



9011.226

LOWER OVERSIZE CASING M6 VENDING
UPPER OVERSIZE CASING M6 VENDING



8



11030779

ІЗОЛЯЦІЯ НИЖНЬОЇ ЧАСТИНИ БОЙЛЕРА 600CC
COFFEE BOILER 600CC UPPER ISOLATOR



9

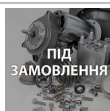

11025322

BOILER ASS. CRISTALLO600TTT 120/60 UL
BOILER ASS. CRISTALLO600TTT 120/60 UL



10



9111.610

CHASE BOILER
STAFFA CALDAIA



11



U207.001

PLAIN WASHER 5,3X10 UNI 6592 GAL
ROSETTA PIANA 5,3X10 UNI 6



12































U043.021

SCREW TCBC M5,0X8 UNI 7687 GALV.
VITE TCBC M5,0X8 UNI 7687 ZNP

Model Machine

MACSAE113

















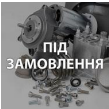







SAECO CRISTALLO 600 ЧЁРНАЯ

	13		189428700	THERMOSTAT 175° 1NT-15L-5126 <i>THERMOSTAT 175° 1NT-15L-5126</i>
	14		11000090	ASS.SENSOR FS400 <i>ASS.SENSORE X FS400</i>
	14		11003810	SENSOR ASS.CRISTALLO400 120V <i>SENSOR ASS.CRISTALLO400 120V</i>
	15		9991.085	THERMOSTAT FIXING WASHER <i>RONDELLA FERMATERMOSTATI</i>
	16		NE09.021	THERMOSTAT 150°NC FASTON 90° <i>TERMOSTATO 150°NC FASTON 90°</i>
	17		U023.020	SCREW TCEI M6X20 UNI 5931 ZIN <i>VITE TCEI M6X20 UNI 5931 8.8</i>
	18		NE15.031	MALE TONGUE PLAIN 6,3 D.6,3 <i>MALE TONGUE PLAIN 6,3 D.6,3</i>
	19		11011454	"T" CONNECTOR FOR BOILER TEAT" <i>RACCORDO A T X CALDAIA TEA</i>
	20		9991.029	NUT FOR RESISTOR <i>DADO X RESISTENZA</i>
	21		12001052	SCREW TCEI M4,0X6 DIN 912 ZIN <i>SCREW TCEI M4,0X6 DIN 912 ZIN</i>
	22		226830200	RETAIN.SPRING 3 THERM. +THERMAL FUSE <i>RETAIN.SPRING 3 THERM. +THERMAL FUSE</i>
	23		11025292	TEFLON TUBE 3X6 L.230 1/8"-1/8 <i>TEFLON TUBE 3X6 L.230 1/8"-1/8</i>
	24		9991.035	NUT 1/8 H 4.5 <i>DADO 1/8 H.4,5</i>
	25		11023762	ELECTROVALVE OLAB 3 WAYS 24V DC TEA <i>ELETTROVALVOLA OLAB 3 VIE 24V DC TEA</i>

Model Machine

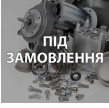
MACSAE113













SAECO CRISTALLO 600 ЧЁРНАЯ

	25		11032408	ELECTROVALVE ODE 3 WAYS 24V DC <i>ELECTROVALVE ODE 3 WAYS 24V DC</i>
	26		9972.057	КОРИЧНЕВА ГУМОВА ТРУБКА 5X8 2 МЕТРИ <i>TUBO SILICONE MARRON 5X8 L.2000 MM</i>
	27		11030777	COFFEE BOILER 600CC UPPER ISOLATOR <i>COFFEE BOILER 600CC UPPER ISOLATOR</i>
	28		20007307	SPARE EVT HS1 11023762 <i>SPARE EVT HS1 11023762</i>
	29		20005373	SOLENOID X HS1 11023762 <i>SOLENOID X OLAB 24V DC 6000BH/BODN</i>
	29		20007361	SOLENOID EVT ODE <i>SOLENOID EVT ODE</i>
	30		9991.212	CONNECTOR BOILER SUPPORT <i>RACCORDO SUPPORTO CALDAIA</i>
	30		9991.214	CONNECTOR NIK BOILER SUPPORT <i>RACCORDO SUPPORTO CALDAIA NIK</i>
	31		140321462	O-RING 2018 SILICONE <i>OR 2018 IN SILICONE</i>
	32		9161.213	BOILER TEFLON SUPPORT <i>BOILER TEFLON SUPPORT</i>
	32		9161.271	BRASS BOILER SUPPORT NIK <i>BRASS BOILER SUPPORT NIK</i>
	33		9111.473	INSULATOR FOR BOILER SUPPORT <i>ISOLANTE X SUPPORTO CALDAIA</i>
	34		9011.005	PEG FOR BOILER <i>PERNO X CALDAIA</i>

Model Machine

MACSAE113

SAECO CRISTALLO 600 ЧЁРНАЯ



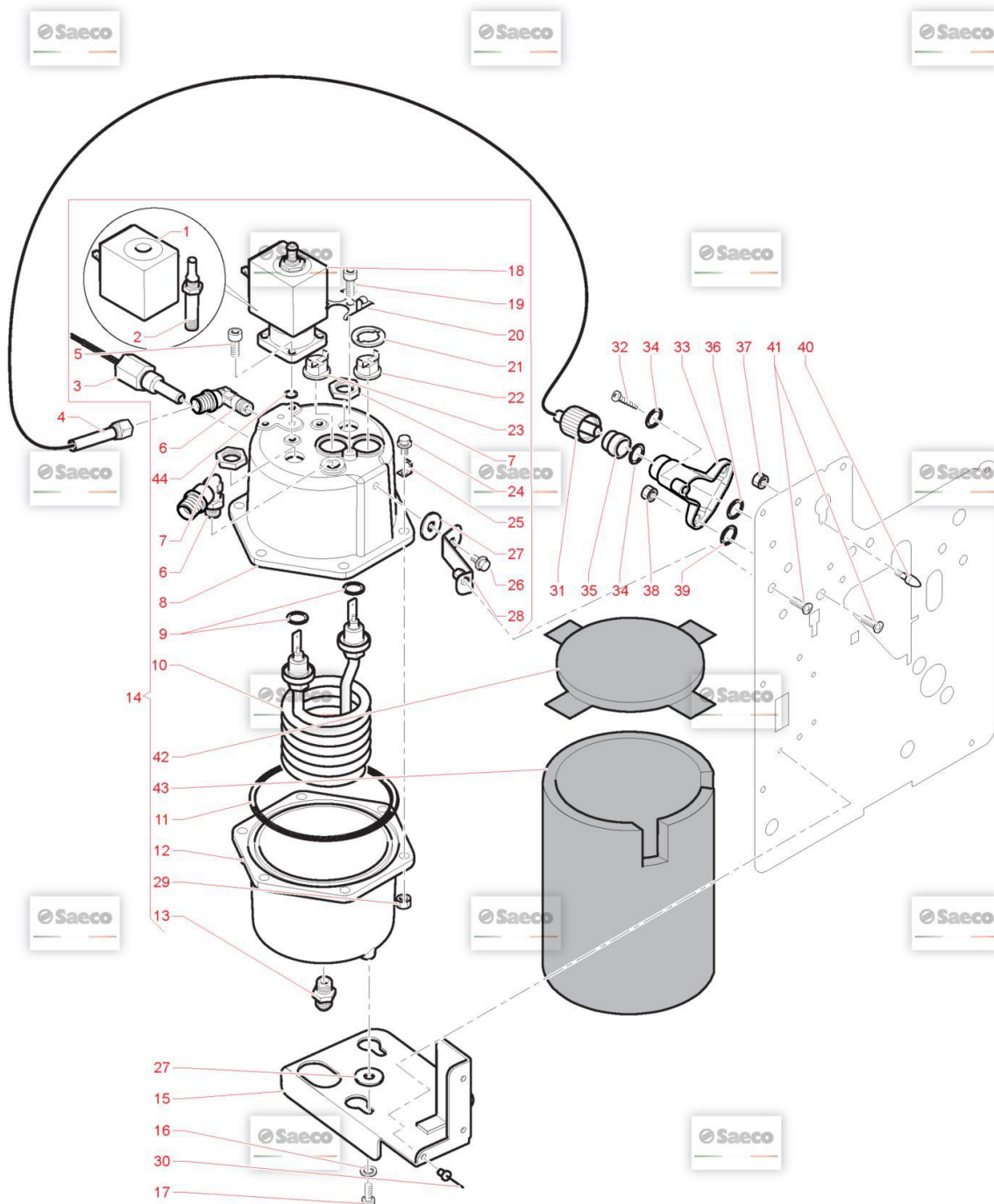









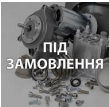













	35		U044.013	SCREW TSPC M4,0X12 UNI 7688 GALV. VITE TSPC M4,0X12 UNI 7688 ZNP
	36		20007305	ЧАСТИНА ЕЛЕКТРОМАГНІТНОГО КЛАПАНА З ПОДВИЖНИМ СЕРДЕЧНИК... SPARE EV MOBILE CORE 11023762
	36		20007362	SPARE CORE EV ODE RIC. NUCLEO EVT ODE
	37		20007306	SPARE EVT HS1 11023762 SPARE EVT HS1 11023762
	37		20007363	SPARE EVT ODE SPARE EVT ODE
	38		20007364	SPARE EVT 11032408 SPARE EVT 11032408



Model Machine

MACSAE113











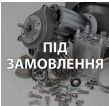

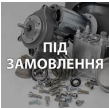













SAECO CRISTALLO 600 ЧЁРНАЯ

Web	Pos.	Foto	Item - Replace by	Description
				<i>Press - CTRL + CLICK go to item in a new window Натисніть - Ctrl + права кнопка миші щоб відкрити запчастину в новому вікні</i>
	1		20006973	SOLENOID X ELECTROVALVE OLAB 8000BH/B0LN <i>SOLENOID X ELECTROVALVE OLAB 8000BH/B0LN</i>
	2		20006974	MOBILE NUCLEUS OLAB 8000-836 <i>MOBILE NUCLEUS OLAB 8000-836</i>
	3		11005368	IMMERSION PROBE ASS. <i>ASS.SONDA TEMPER.AD.IMMERSIONE</i>
	4		11025409	TUBE ASSEMBLY TEFLON 3X6 L.220MM <i>TUBE ASSEMBLY TEFLON 3X6 L.220MM</i>
	5		12001179	SCREW TCEI M4,0X12 UNI 5931 8.8 ZIN. <i>SCREW TCEI M4,0X12 UNI 5931 8.8 ZIN.</i>
	6		11025082	1/8"G M/CONICAL ORIENT. NUT/OGV <i>1/8G M/CONICAL ORIENT. NUT/OGV</i>
	7		9991.029	NUT FOR RESISTOR <i>DADO X RESISTENZA</i>
	8		11012528	UPPER CASING BOILER 600CC TEA <i>UPPER CASING BOILER 600CC TEA</i>
	9		11000972	OR 3050 FKM 80 FD PEROXIDICA <i>OR 3050 FKM 80 FD PEROXIDICA</i>
	10		11005374	HEAT ELEMENT BOILER 120V 1100W <i>HEAT ELEMENT BOILER 120V 1100W</i>
	11		12000770	OR ORM 4350 VITON <i>OR METRICO 4350 IN VITON</i>
	12		11012529	LOWER CASING BOILER 600CC TEA <i>LOWER CASING BOILER 600CC TEA</i>
	13		11027089	WATER INLET CONNECTOR <i>WATER INLET CONNECTOR</i>

Model Machine

MACSAE113























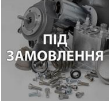

SAECO CRISTALLO 600 ЧЁРНАЯ

	14		11025320	BOILER ASS. CRISTALLO600 600CC120/60 TEA <i>BOILER ASS. CRISTALLO600 600CC120/60 TEA</i>
	15		11008090	SUPPORT PLATE BOILER 600CC <i>SUPPORT PLATE BOILER 600CC</i>
	16		U207.001	PLAIN WASHER 5,3X10 UNI 6592 GAL <i>ROSETTA PIANA 5,3X10 UNI 6</i>
	17		U005.011	SCREW TE M4,0X10 UNI 5739 GALV. <i>SCREW TE M4,0X10 UNI 5739 GALV.</i>
	18		11012534	TEA ELECTROVALVE 2/3 WAY N.C. <i>TEA ELECTROVALVE 2/3 WAY N.C.</i>
	19		12001052	SCREW TCEI M4,0X6 DIN 912 ZIN <i>SCREW TCEI M4,0X6 DIN 912 ZIN</i>
	20		226760100	RETAINING SPRING 3 THERMOSTATS <i>RETAINING SPRING 3 THERMOSTATS</i>
	21		9991.085	THERMOSTAT FIXING WASHER <i>RONDELLA FERMATERMOSTATI</i>
	22		NE09.021	THERMOSTAT 150°NC FASTON 90° <i>TERMOSTATO 150°NC FASTON 90°</i>
	23		189428700	THERMOSTAT 175° 1NT-15L-5126 <i>THERMOSTAT 175° 1NT-15L-5126</i>
	24		U023.020	SCREW TCEI M6X20 UNI 5931 ZIN <i>VITE TCEI M6X20 UNI 5931 8.8</i>
	25		NE15.031	MALE TONGUE PLAIN 6,3 D.6,3 <i>MALE TONGUE PLAIN 6,3 D.6,3</i>
	26		U046.005	SCREW TE M5,0X10 WITH WASHER <i>SCREW TE M5,0X10 WITH WASHER</i>
	27		9111.501	INSULATION WASHER <i>INSULATION WASHER</i>

Model Machine

MACSAE113

SAECO CRISTALLO 600 ЧЕРНАЯ

	28		11008063	BOILER 600CC SUPPORT CRISTALLO600 <i>SUPPORTO CALDAIA 600CC CRISTALLO600</i>
	29		U302.004	NUT HEXAGONAL M6 UNI 5588 <i>DADO ESAGONALE M6 UNI 5</i>
	30		NF11.115	BLIND RIVETS <i>BLIND RIVETS</i>
	31		11005743	KNURLED FEMALE HAND BOLT M14 <i>GODRONE FEMMINA M14</i>
	32		U109.037	SCREW AUT.TCB 4,8X13 DIN 7981C <i>VITE AUT.TCB 4,8X13 DIN 7981 C NIK</i>
	33		11013431	PHEDRA TTT SLEEVE TTT CIRCUIT <i>PHEDRA TTT SLEEVE TTT CIRCUIT</i>
	34		140321462	O-RING 2018 SILICONE <i>OR 2018 IN SILICONE</i>
	35		11005741	CONNECTOR D.6 <i>BOCCOLA ESTERNA D.6</i>
	36		11013173	OR ORM 0090-20 FKM 80 FD GREENPEROXIDA <i>OR ORM 0090-20 FKM 80 FD GREEN PEROXIDA</i>
	37		U302.001	NUT HEXAGONAL M5 UNI 5588 <i>DADO ESAGONALE M5 UNI 5</i>
	38		U302.003	GALV.NUT HEXAGONAL M4 UNI 5589ZN <i>DADO ESAGONALE M4 UNI 5588 ZNP</i>
	39		11013174	OR ORM 0050-20 FKM 80 FD GREENPEROXIDA <i>OR ORM 0050-20 FKM 80 FD GREEN PEROXIDA</i>
	40		11006046	PEG FOR BOILER <i>PEG FOR BOILER</i>

Model Machine

MACSAE113

SAECO CRISTALLO 600 ЧЁРНАЯ



41



U044.013

SCREW TSPC M4,0X12 UNI 7688 GALV.
VITE TSPC M4,0X12 UNI 7688 ZNP



42



11030776

COFFEE BOILER 600CC UPPER ISOLATOR
ISOLANTE SUP.CALDAIA 600CC VENDING



43



11030778

COFFEE BOILER 600CC UPPER ISOLATOR
ISOLANTE PERIMETR.CALDAIA 600CC VENDING



44



20007312

SPARE OR EVT HS2 11012534
SPARE OR EVT HS2 11012534

Model Machine

MACSAE113

SAECO CRISTALLO 600 ЧЁРНАЯ

MACSAE113.T.0018



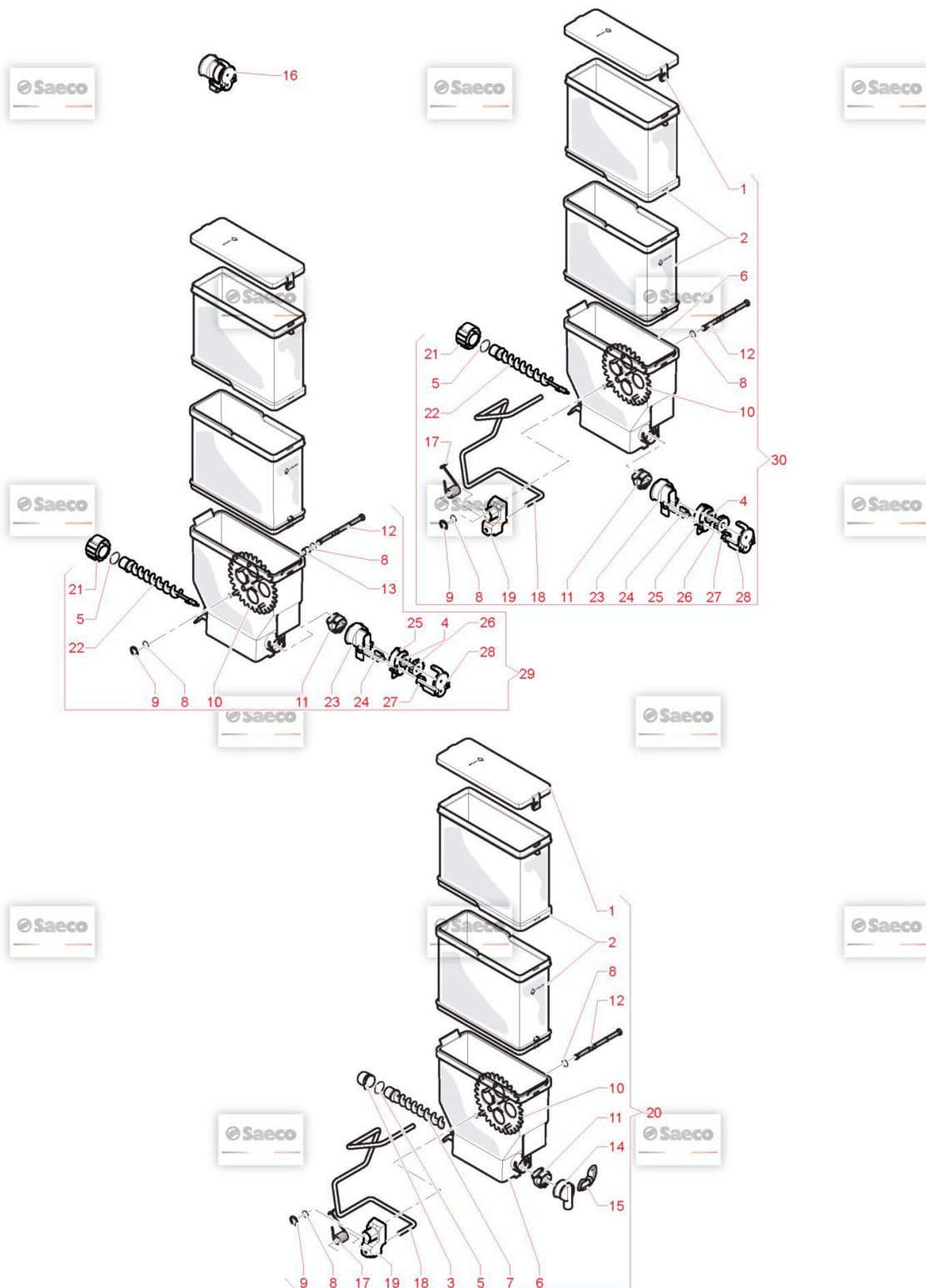























TAVOLA NR. 18 - ARTICOLO SAECO CRISTALLO 600 ЧЁРНАЯ



Model Machine

MACSAE113

























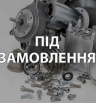

SAECO CRISTALLO 600 ЧЁРНАЯ

Web	Pos.	Foto	Item - Replace by	Description
				<i>Press - CTRL + CLICK go to item in a new window Натисніть - Ctrl + права кнопка миші щоб відкрити запчастину в новому вікні</i>
	1		11001578	COVER CONTAINER SINGLE SOLUBLE COPERCHIO CONTENITORE SOLUBILE SINGOLO
	2		11001577	EXTENSION CONTAINER SINGLE SOLUBLE PROLUNGA CONTENITORE SOLUBILE SINGOLO
	3		11005457	REAR BUSH NEW BOCCOLA POSTERIORE UN SOLO AGGANCIO NEW
	4		11031692	FELT RING DE=47,4 DI=41,4H=4 FELT RING DE=47,4 DI=41,4H=4
	5		NM03.013	OR 2,3X15 NBR OR 2,3X15 NBR
	6		11001576	BASE CONTAINER SINGLE SOLUBLE BASE CONTENITORE SOLUBILE SINGOLO
	7		9111.701	SCROLL SCREW DOUBLE CONTAINER COCLEA CONTENITORE DOPPIO
	8		NM03.022	OR ORM 0060-10 NBR OR ORM 0060-10 NBR
	9		U701.003	SNAP RING 7 UNI 7434 ANELLO ELASTICO 7 UNI 7434
	10		9111.702	WHEEL DOUBLE CONTAINER RUOTA CONTENITORE DOPPIO
	11		11028378	FRONT BUSH FRONT BUSH
	12		11001580	PIN WHEEL CONTAINER SINGLE SOLUBLE PERNO RUOTA DENTATA CONT.SOLUB.SINGOLO
	13		11032945	SPACE FOR GEAR BPA FREE SPACE FOR GEAR BPA FREE

Model Machine

MACSAE113

SAECO CRISTALLO 600 ЧЁРНАЯ

	14		9111.629.060	APERTURE FOR SOLUBLES HOPPER <i>APERTURE FOR SOLUBLES HOPPER</i>
	15		9111.338.270	BULKHEAD FOR APERT. CLOSURE ORANGE <i>PARATIA CHIUSURA BOCCHETTA ARANCIO</i>
	16		21002190	KIT EASY DRY 2 <i>KIT EASY DRY</i>
	17		9111.731	SPRING <i>MOLLA AGITATORE</i>
	18		11006124	WIRE AGITATOR UNIFIED <i>FILO AGITATORE UNIFICATO WIRE AGITATOR UNIFIED</i>
	19		11007155	ПЛАСТИКОВИЙ ТРИМАЧ ВЗБИВАЛКИ SAECO 9111.735 <i>AGITATOR SUPPORT</i>
	20		11031640	ASSEMBLY SINGLE CONTAINER WITH AGITATOR <i>ASSEMBLY SINGLE CONTAINER WITH AGITATOR</i>
	21		11012130	BACK BUSH REINFORCE <i>BACK BUSH REINFORCE</i>
	22		11005180	SCROLL SCREW FOR NEW DISPENSER APERTURE <i>COCLEA X BOCCHETTA EROGAZIONE APERTURE SCROLL SCREW FOR ...</i>
	23		11031678	EASY DRY DISPENSER APERTURE <i>EASY DRY DISPENSER APERTURE</i>
	24		11031679	DISPENSER FAN EASY DRY <i>DISPENSER FAN EASY DRY</i>
	25		11031691	CARTER FOR GEAR EASY DRY <i>CARTER FOR GEAR EASY DRY</i>
	26		11031690	WHEEL Z=18 EASY DRY <i>WHEEL Z=18 EASY DRY</i>
	27		11005182	WHEEL Z=9 <i>WHEEL Z=9</i>

Model Machine

MACSAE113

SAECO CRISTALLO 600 ЧЁРНАЯ



28



11005168

LID CARTER GEAR
LID CARTER GEAR



29



11031883

ASSEMBLY SINGLE CONTAINER
ASSEMBLY SINGL CONTAINER



30



11031886

ASSEMBLY SINGLE CONTAINER
ASSEMBLY SINGLE CONTAINER

Model Machine

MACSAE113

SAECO CRISTALLO 600 ЧЁРНАЯ

MACSAE113.T.0019



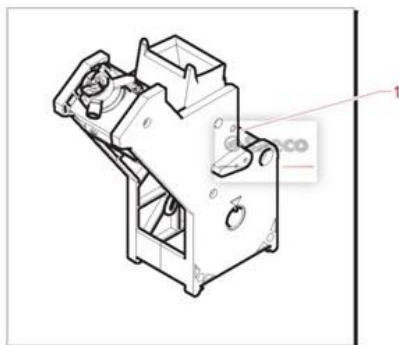
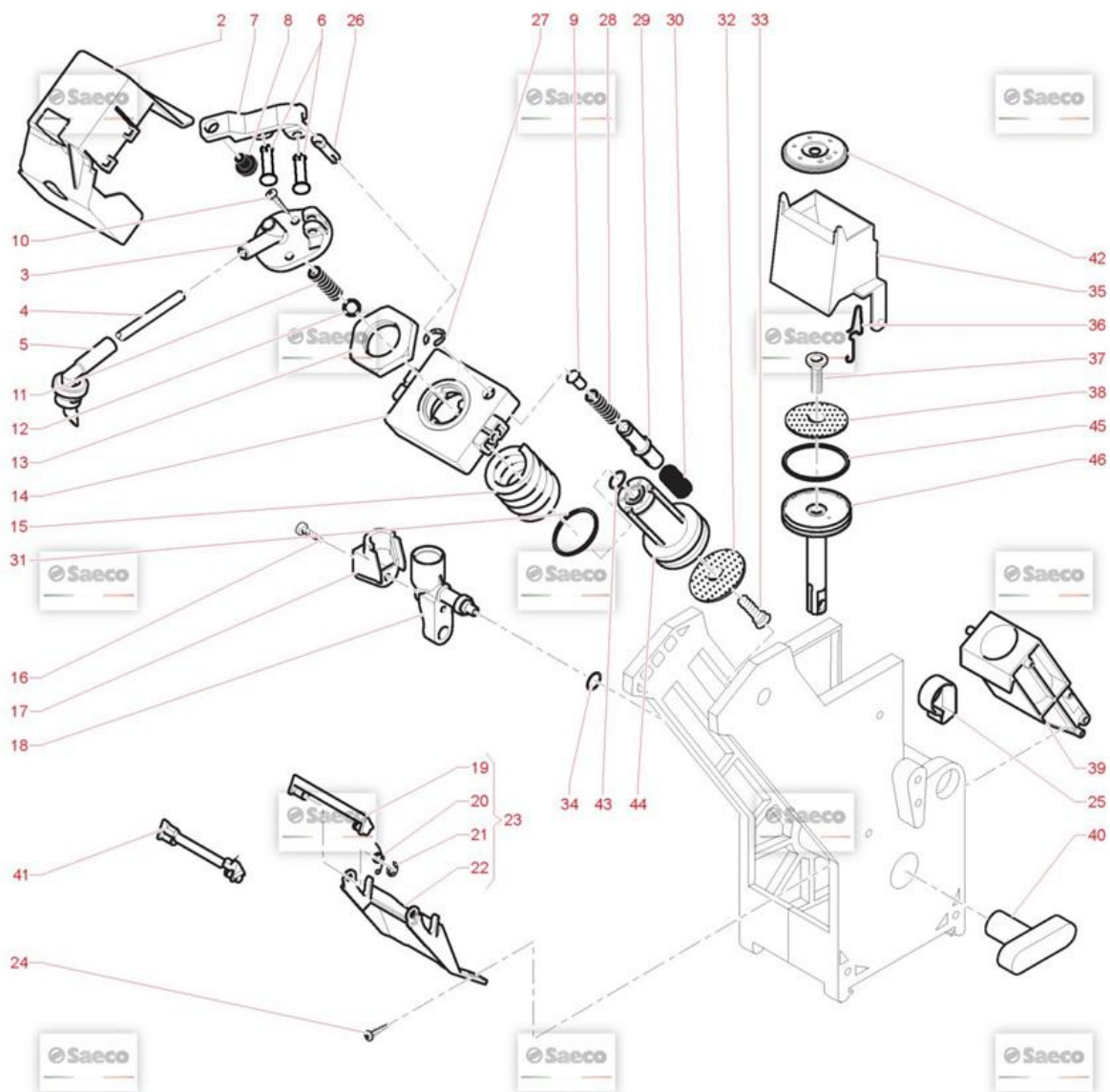























TAVOLA NR. 19 - ARTICOLO SAECO CRISTALLO 600 ЧЁРНАЯ



Model Machine

MACSAE113





























SAECO CRISTALLO 600 ЧЁРНАЯ

Web	Pos.	Foto	Item - Replace by	Description
				<i>Press - CTRL + CLICK go to item in a new window Натисніть - Ctrl + права кнопка миші щоб відкрити запчастину в новому вікні</i>
	1		11030408	BREWING UNIT ASS. 7GR GRAN GUSTO ASS. GRUPPO CAFFE 6/8GR NEW
	2		11029737	PROTECTION VALVE PROTEZIONE VALVOLA SFIATO GRUPPO CAFFE
	3		11029311	COVER BALL VALVE COPERCHIO VALVOLA SFERA
	4		9972.345	SILICONE TUBE 3,5X9 L.340MM SILICONE TUBE 3,5X9 L.340MM
	5		11033574	COFFEE NOZZLES COFFEE NOZZLES
	6		11030836	PIN FIXING VALVE SUPPORT PIN FIXING VALVE SUPPORT
	7		11029312	BREATHER VALVE CLOSED CHIUSURA VALVOLA SFIATO
	8		NV01.009	RUBBER BUFFER GOMMINO PARACOLPI
	9		9161.320	VALVE FOR UNIT VALVOLA X GRUPPO CAFFE'
	10		U109.006	SCREW AUT.TCB 2,2X9,5 DIN 7981C VITE AUT.TCB 2,2X9,5 DIN 7981 C NIK
	11		126771918	SS COFFEE UNIT CONTERPISTON SPRING SMART MOLLA CONTROPIST. GRUP. SMART INOX
	12		12001811	SPHERE TEFLON D.4,5 SFETA D.4.5 TEFLON X VALVOLA GRUPPO CAFF
	13		11029317	NUT SEAL PISTON MOVABLE DADO TENUTA CONTROPISTONE MOBILE

Model Machine

MACSAE113



























SAECO CRISTALLO 600 ЧЁРНАЯ

	14		11029316	FLANGE FOR CUPHOLDER <i>FLANGIA X PISTONE MOBILE</i>
	15		11029308	SPRING FOR MOVABLE COUNTERPISTON <i>MOLLA X CONTROPISTONE MOBILE</i>
	16		129512921	SCREW TCB TORX 10 AB 2,9X13 SHEET SS <i>SCREW TCB TORX 10 2,9X13 SHEET SS</i>
	17		11010013	CARTER FOR MUFF PREHEATING UNIT <i>CARTE X MANICOTTO GRUPPO PRERISCALDO</i>
	18		11005371	UNIT COFFEE MUFF <i>MANICOTTO GRUPPO CAFFE' UNIT COFFEE MUFF</i>
	19		9111.537.060	BROWN SCRAPER COFFEE GROUP <i>BROWN SCRAPER COFFEE GROUP</i>
	20		9111.520	SPRING FOR SCRAPER SECTION 0.6 <i>SPRING FOR SCRAPER SECTION 0.6</i>
	21		U701.006	SNAP RING 3,2 UNI 7434 <i>ANELLO ELASTICO 3,2</i>
	22		9111.539.060	FORK FOR SCRAPER <i>FORCELLA PER RASCHIATORE</i>
	23		9110.067.060	SCRAPER ASS.FOR CAPPUCINAT. TUBE <i>ASS.RASCHIATORE X SG500/700</i>
	24		U110.013	SCREW AUT.TCB 3,9X6,5 DIN 7981F <i>SCREW AUT.TCB 3,9X6,5 DIN 7981 F</i>
	25		11030309	RING FOR CAM <i>ANELLO X CAMMA PISTONE</i>
	26		11029313	CURSOR COMPENSATOR VALVE VENT <i>CURSORE COMPENSATORE X VALVOLA SFIATO</i>
	27		U701.007	SNAP RING 6 UNI 7434 <i>ЕЛАСТИЧНЕ КІЛЬЦЕ 6 UNI 7434 (ЗАЛІЗО)</i>

Model Machine

MACSAE113

SAECO CRISTALLO 600 ЧЁРНАЯ

	28		11029310	SPRING FOR RELIEF VALVE <i>MOLLA COMPENSATRICE X VALVOLA SFIATO</i>
	29		11029314	CURSOR FOR VALVE VENT <i>CURSORE X VALVOLA SFIATO</i>
	30		11029309	SPRING FOR RELIEF VALVE <i>MOLLA X VALVOLA SFIATO</i>
	31		140322061	O-RING 4112 EPDM <i>OR 4112 IN EPDM</i>
	32		11012630	PERCOLATOR D.34 <i>PERCOLATOR D.34</i>
	33		U044.009	SS SCREW TSPC M3,0X8 UNI 7688 <i>VITE TSCP M3,0X8 UNI 7688 INO</i>
	34		140321462	O-RING 2018 SILICONE <i>OR 2018 IN SILICONE</i>
	35		322001201	MOBILE SCRAPER BROWN NARROW <i>MOBILE SCRAPER BROWN NARROW</i>
	36		9161.425	SPRING FOR SCRAPER <i>SPRING FOR SCRAPER</i>
	37		129851921	TSP SCREW M3X6 UNI 7688 SS <i>TSP SCREW M3X6 UNI 7688 SS</i>
	38		324000200	SS PERCOLATOR D=34 FOR UNIT <i>SS PERCOLATOR D=34 FOR UNIT</i>
	39		222711101	BROWN GROUND COFF.CONTAINER D=36 ASSY. <i>BROWN GROUND COFF.CONTAINER D=36 ASSY.</i>
	40		9161.021.060	KEY FOR BREW UNIT BROWN <i>CHIAVE X GRUPPO CAFFE' MARRO</i>

Model Machine

MACSAE113

SAECO CRISTALLO 600 ЧЁРНАЯ

	41		11012957	SCRAPER FOR COFFEE UNIT 7-9GR. <i>SCRAPER FOR COFFEE UNIT 7-9GR.</i>
	42		11030122	SPACE <i>SPACE</i>
	43		NM01.029	OR ORM 0100-15 SILICONE <i>OR ORM 0100-15 SILICONE</i>
	44		11029878	ASS.CONTROPISTONE MOBILE <i>ASS.CONTROPISTONE MOBILE</i>
	45		140322500	ПРОКЛАДКА O-RING 2118 SH70 BIANCHI 36363116-01, SAECO 140322500 <i>OR 2118 IN NITRIL RUBBER</i>
	46		11029879	ASS.PISTONE X GRUPPO CAFFE' <i>ASS.PISTONE X GRUPPO CAFFE'</i>

Model Machine

MACSAE113

SAECO CRISTALLO 600 ЧЁРНАЯ

MACSAE113.T.0020

TAVOLA NR. 20 - ARTICOLO SAECO CRISTALLO 600 ЧЁРНАЯ

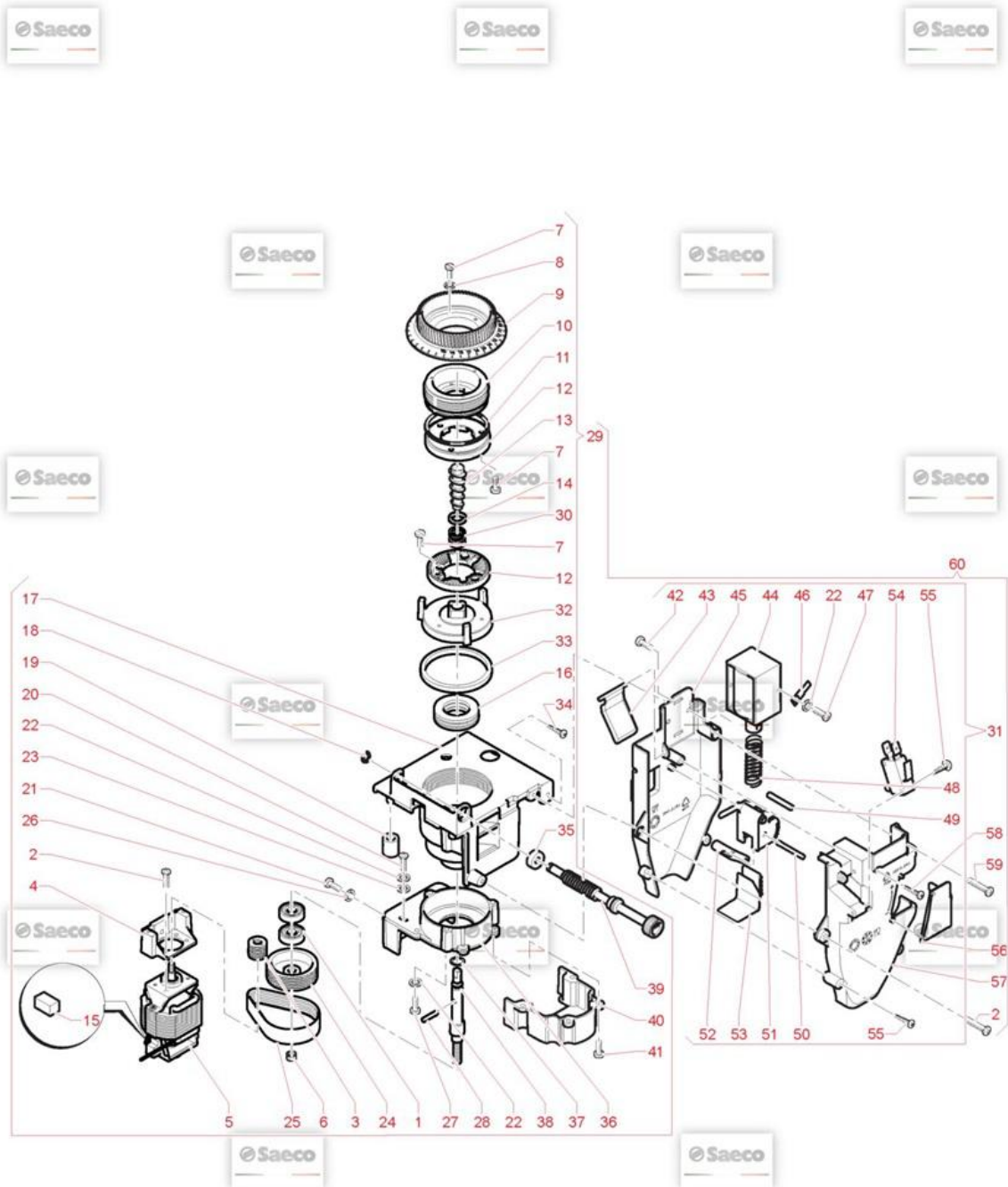

Model Machine

MACSAE113

SAECO CRISTALLO 600 ЧЁРНАЯ

Web Pos. Foto Item - Replace by Description



*Press - CTRL + CLICK go to item in a new window
Натисніть - Ctrl + права кнопка миші щоб відкрити запчастину в новому вікні*



1



11025696

BEARING RTP 608-2Z
BEARING RTP 608-2Z



2



12002039

SCREW TCBD TORX 20 M4X12 ZN-B
VITE TCBD TORX 20 M4X12 ZN-B



3



11025690

PULLEY D.15 "GRIND 48"
PULLEY D.15 "GRIND 48"



4

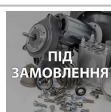

11027163

MOTOR SUPPORT GRINDERS D.48
MOTOR SUPPORT GRINDERS D.48



5

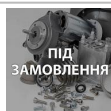

11027396

COFFEEGRINDER MOTOR D.48 230V
COFFEEGRINDER MOTOR D.48 230V



6



U310.004

NUT SELF LOCK.M6 UNI 7473
NUT SELF LOCK.M6 UNI 7473



7



U043.007

SCREW TCBC M3,0X8 UNI 7687 GALV.
SCREW TCBC M3,0X8 UNI 7687 GALV.



8



U208.002

TOOTHED WASHER 3,3X5,8 UNI 3703 G
ROSETTA DENT. 3,3X5,8 UNI 3703 ZNP



9



1813.103.A20

RING NUT OF GRIND REGULATION
RING NUT OF GRIND REGULATION



10



11025692

UPPER GRINDING DISK HOLDER "GRIND 48"
UPPER GRINDING DISK HOLDER "GRIND 48"



11



12001617

OR 3206 NBR
OR 3206 NBR



12



11021838

FLAT MILL D.48 TEA
FLAT MILL D.47 TEA



13















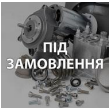













11025695

ШНЕК БОЛТИК ЗБІЛЬШЕННЯ "MACINE 48"
INCREASE SCREW "GRIND 48"

Model Machine

MACSAE113

























SAECO CRISTALLO 600 ЧЕРНАЯ

	14		11027418	SPACER FOR SCREW OF INCREASE <i>SPACER FOR SCREW OF INCREASE</i>
	15	 ПІД ЗАМОВЛЕННЯ	20007420	MOTOR BRUSH <i>MOTOR BRUSH</i>
	16		11025699	BEARING RTP 51104 <i>BEARING RTP 51104</i>
	17		11027162	GRINDERS CAP D.48 <i>GRINDERS CAP D.48</i>
	18		U701.011	STEEL SNAP RING 5 UNI 7434 <i>ANELLO ELASTICO 5 UNI 7434</i>
	19		1813.046.050	RUBBER GRIND SUPPORT <i>RUBBER GRIND SUPPORT</i>
	20		12002052	ZN-B TCB SCREW M4X16 <i>ZN-B TCB SCREW M4X16</i>
	21		U023.004	SCREW TCEI M6,0X12 UNI 5931 GALV. <i>VITE TCEI M6,0X12 UNI 5931 Z</i>
	22		128310404	МЕТАЛЕВЕ УБЧАСТЕ КОЛИЩАТКО UNI 8842 A4 <i>WASHER UNI 8842 A4 BURNISHED</i>
	23		U207.004	PLAIN WASHER 4,3X16 UNI 6592 GAL <i>PLAIN WASHER 4,3X16 UNI 6592 GAL</i>
	24	 ПІД ЗАМОВЛЕННЯ	11025689	PULLEY D.40 "GRIND 48" <i>PULLEY D.40 "GRIND 48"</i>
	25		11032130	BELT GRINDER COFFEE <i>BELT GRINDER COFFEE</i>
	26		U208.006	TOOTHED WASHER 6,4X11 UNI 3703 <i>ROSETTA DENT. 6,4X11 UNI 3</i>
	27	 ПІД ЗАМОВЛЕННЯ	12001700	SCREW TCB M4X30 UNI 7687 ZNP <i>SCREW TCB M4X30 UNI 7687 ZNP</i>

Model Machine

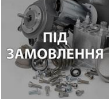
MACSAE113















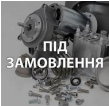











SAECO CRISTALLO 600 ЧЁРНАЯ

	28		11025921	POWER PLUG UNI-EN 28743 D.3X14 <i>POWER PLUG UNI-EN 28743 D.3X14</i>
	29		11027165	КАВОМОЛКА В ЗБОРІ Д 48 SAECO 11027165 <i>COFFEE GRINDER D.48</i>
	29		11027808	COFFEE GRINDER CRISTALLOTTT 120V <i>COFFEE GRINDER CRISTALLOTTT 120V</i>
	30		11025694	SPRING "GRIND 48" <i>SPRING GRIND 48</i>
	31		11033675	DOSER <i>DOSER</i>
	31		1813.A10.A2N	DOSER ASS. 6-11 GR. 220V 60HZ <i>DOSER ASS. 6-11 GR. 220V 60HZ</i>
	32		11025691	ТРИМАЧ НИЖНЬОГО НОЖА Д.48 <i>LOWER GRINDING DISK HOLDER GRIND 48</i>
	33		11027451	ПРОКЛАДКА DE=47,4 DI=41,4H=4 IN F <i>ПРОКЛАДКА DE=47,4 DI=41,4H=4 IN F</i>
	34		U116.006	SCREW AUT.PT TCB 3,5X12 WN 1441 ZNP <i>VITE AUT.PT TCB 3,5X12 WN 1441 ZNP</i>
	35		1813.159	ANTIVIBRATION RUBBER <i>ANTIVIBRATION RUBBER</i>
	36		11027164	MOTOR SUPPORT GRINDERS D.48 <i>MOTOR SUPPORT GRINDERS D.48</i>
	37		140321662	O-RING 2021 SILICONE <i>OR 2021 IN SILICONE</i>
	38		11025693	CENTRAL PIN "GRIND 48" <i>CENTRAL PIN "GRIND 48"</i>

Model Machine

MACSAE113















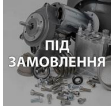

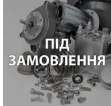

SAECO CRISTALLO 600 ЧЁРНАЯ

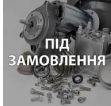
	39		1813.104.A20	ADJUSTMENT SCREW WITH TUBE HOLDER <i>VITE REGOLAZIONE MACININO</i>
	40		11027186	SHELL CLOSURE BELT <i>SHELL CLOSURE BELT</i>
	41	 ПІД ЗАМОВЛЕННЯ	U127.010	SCREW TAPT.TCB M4,0X10 DIN 7500C <i>SCREW TAPT.TCB M4,0X10 DIN 7500C</i>
	42	 ПІД ЗАМОВЛЕННЯ	12002151	TSP SCREW M3X4 UNI 7688 SS <i>TSP SCREW M3X4 UNI 7688 SS</i>
	43	 Liberty	1813.042.A20	DISPENSER PALLET <i>DISPENSER PALLET</i>
	44		9121.235.00A	ELECTROMAGNET FOR DISPENSER WITH NUCLEUS <i>ELETTROM. PER DOSATORE CON NUCLEO</i>
	45	 ПІД ЗАМОВЛЕННЯ	11033683	DISPENSER SHELL <i>DISPENSER SHELL</i>
	46		NE15.003	MALE TONGUE PLAIN 6,3 D.5,2 <i>LINGUETTA MASCHIO PIANA 6,3 D.5,2</i>
	47		129821402	TCB SCREW M3X4 UNI 7687 ZNP <i>TCB SCREW M3X4 UNI 7687 ZNP</i>
	48		1813.127	SPRING FOR ELECTROMAGNET <i>MOLLA X ELETTROMAGNETE DOSAT</i>
	49		1813.092	PIN <i>PIN</i>
	50		1813.091	PIN FOR DISPENSER REGULATION <i>PIN FOR DISPENSER REGULATION</i>
	51		1813.043.A20	DISPENSER REGULATION <i>REGOLATORE DOSATORE</i>
	52		1813.078.A20	ADJUSTMENT LEVER <i>ADJUSTMENT LEVER</i>

Model Machine

MACSAE113

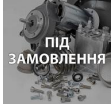
SAECO CRISTALLO 600 ЧЁРНАЯ

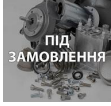
	53		1813.044.A20	PALLET FOR REGULATION <i>PALETTA X REGOLATORE</i>
	54		NE05.062	MICROSWITCH + WHEEL <i>MICROINTERRUTTORE C/ROTELLA</i>
	55		U116.004	SCREW AUT.PT TCB 3,0X16 WN 1441 <i>SCREW AUT.PT TCB 3,0X16 WN 1441</i>
	56		1813.191.A20	DISPENSER COVER <i>COPERTURA DOSATORE</i>
	57		11033684	OUTSIDE SHELL DISPENSER <i>GUSCIO EST.DOSATORE 1813.041.A20 LAV.</i>
	58		12000390	SCREW AUT.TCB 2,9X25 DIN 7981C NIK <i>SCREW AUT.TCB 2,9X25 DIN 7981 C NIK</i>
	59		129825502	TCB SCREW M4X25 UNI 7687 ZNP <i>TCB SCREW M4X25 UNI 7687 ZNP</i>
	60		11032631	COFFEE GRINDER D.48+DISPENCER220V/60HZ <i>COFFEE GRINDER D.48+DISPENCER 220V/60HZ</i>
	60		11033678	COFFEE GRINDER D.48 + DISPENCER <i>COFFEE GRINDER D.48 + DISPENCER</i>
	60		11033887	COFFEE GRINDER CRISTALLOTTT 120V <i>COFFEE GRINDER CRISTALLOTTT 120V</i>