

Model Machine

MACSAE160

CRISTALLO 400 EVO(10004761)

MACSAE160.T.0001



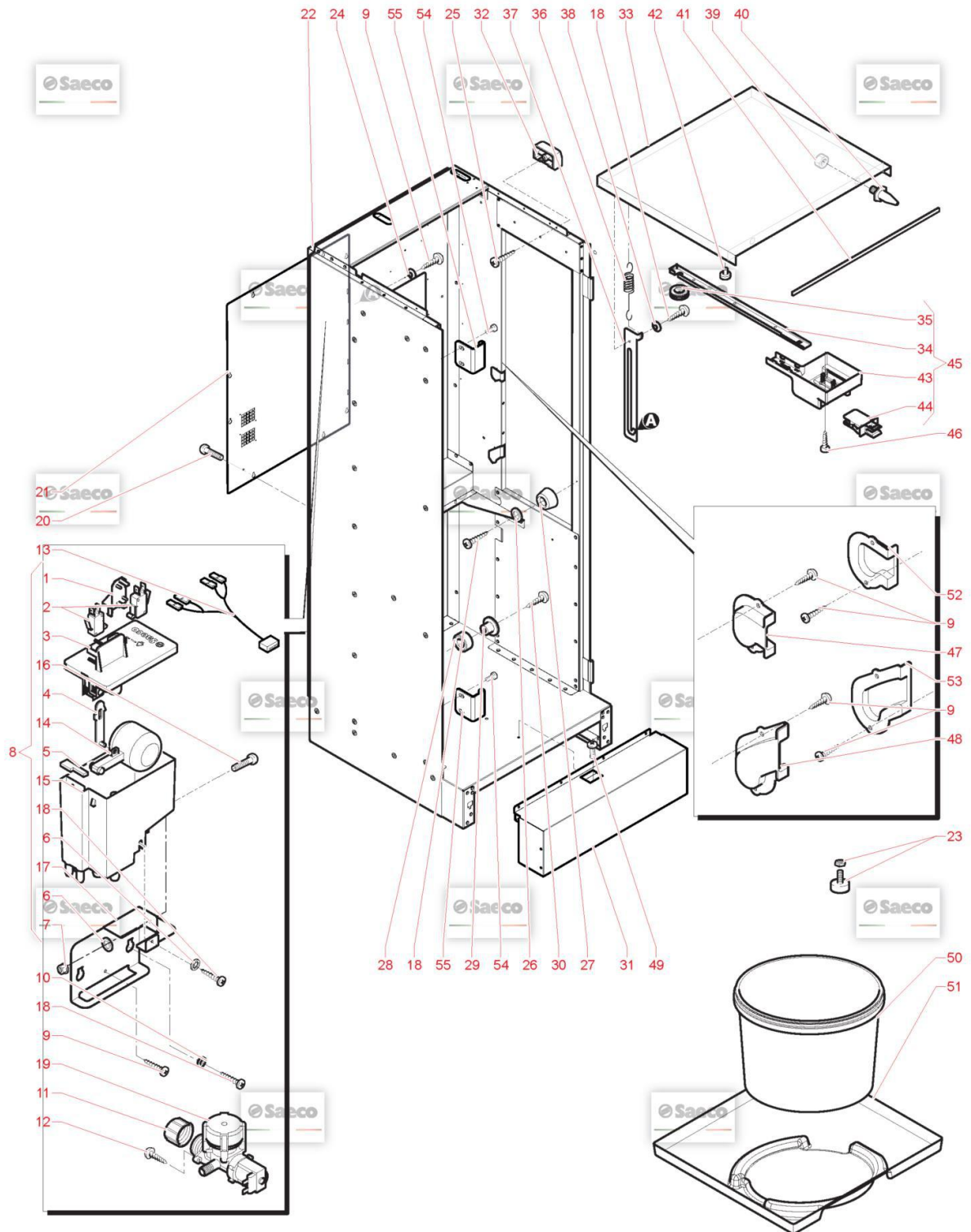





















TAVOLA NR. 1 - ARTICOLO CRISTALLO 400 EVO(10004761)

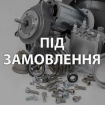

Model Machine

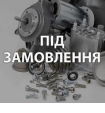
MACSAE160











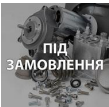



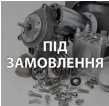











CRISTALLO 400 EVO(10004761)

Web	Pos.	Foto	Item - Replace by	Description
				<i>Press - CTRL + CLICK go to item in a new window Натисніть - Ctrl + права кнопка миші щоб відкрити запчастину в новому вікні</i>
	1		9161.207.150	GREY FAUCET MICRO SUPPORT M5000 <i>SUPPORTO X MICRO RUBINETTO</i>
	2		NE05.062	MICROSWITCH + WHEEL <i>MICROINTERRUTTORE C/ROTELLA</i>
	3		9111.623	LID TANK AIR BREAK <i>COPERCHIO X SERBATOIO AIR BREAK</i>
	4		9111.621	CONNECTING ROD TANK WATER <i>CONNECTING ROD TANK WATER</i>
	5	 ПІД ЗАМОВЛЕННЯ	9111.632	RUBBER FOR AIR BREAK <i>RUBBER FOR AIR BREAK</i>
	6	 ПІД ЗАМОВЛЕННЯ	U207.009	PLAIN WASHER 5,5X15 UNI 6593 GA <i>PLAIN WASHER 5,5X15 UNI 6593 GA</i>
	7	 ПІД ЗАМОВЛЕННЯ	U324.003	NUT M5 FLANGED INDENTED BASE <i>NUT M5 FLANGED INDENTED BASE</i>
	8	 ПІД ЗАМОВЛЕННЯ	11006703	ASSEMBLY AIR BREAK CRISTALLO400 <i>ASSEMBLY AIR BREAK CRISTALLO400</i>
	9		U143.022	SCREW T.M.T. K.F.R. 3,5X9,5 ZNP <i>VITE T.M.T. K.F.R. 3,5X9,5 ZNP</i>
	10	 ПІД ЗАМОВЛЕННЯ	11011054	PIN FOR BOSS D.8 <i>PIN FOR BOSS D.8</i>
	11		NV03.002	КРИШКА КЛАПАНУ ПОДАЧІ ВОДИ 3/4 <i>"CAP 3/4 "KAPSTO 800R 3/4"</i>
	12	 ПІД ЗАМОВЛЕННЯ	U110.002	SCREW AUT.TCB 3,5X13 DIN 7981F <i>SCREW AUT.TCB 3,5X13 DIN 7981 F</i>

Model Machine

MACSAE160











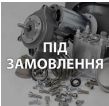

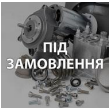













CRISTALLO 400 EVO(10004761)

	13		11006676	HARNESS AIR BREAK MICRO <i>HARNESS AIR BREAK MICRO</i>
	14		9111.508	FLOAT FOR AIR BREAK BOWL <i>FLOAT FOR AIR BREAK BOWL</i>
	15		9111.641	TANK AIR BREAK <i>SERBATOIO AIR BREAK C/FORO</i>
	16		U043.015	SCREW TCBC M5,0X12 UNI 7687 GALV. <i>SCREW TCBC M5,0X12 UNI 7687 GALV.</i>
	17		1863.015	AIR BREAK SUPPORT <i>AIR BREAK SUPPORT</i>
	18		U110.005	SCREW AUT.TCB 3,9X9,5 DIN 7981F <i>VITE AUT.TCB 3,9X9,5 DIN 798</i>
	19		9121.057.00P	SAFETY ELECTROVALVE 24V DC <i>SAFETY ELECTROVALVE 24V DC</i>
	20		U110.003	SCREW AUT.TCB 3,5X9,5 DIN 7981F <i>VITE AUT.TCB 3,5X9,5 DIN 798</i>
	21		11034045	BACK PANEL INSPECTION CRS EVO <i>BACK PANEL INSPECTION CRS EVO</i>
	22		11033839	CRS400 EVO CHASSIS <i>ASS.CARCASSA RIVETTATA CRS400 EVO</i>
	23		NV01.002	FOOT D.34 H.35 WITH NUT M10 <i>PIEDINO D.34 H.35 CON DADO M</i>
	24		1602.147	BUSH FOR DOOR CONNECTING ROD <i>BUSH FOR DOOR CONNECTING ROD</i>
	25		U109.003	SCREW TCB 3,5X9,5 DIN 7981 C NICK <i>SCREW TCB 3,5X9,5 DIN 7981 C NICK</i>
	26		U203.001	ШАЙБА 4,3X8 UNI 1749 GA <i>PLAIN WASHER 4,3X8 UNI 1749 GAL</i>

Model Machine

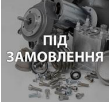
MACSAE160























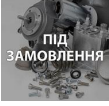

CRISTALLO 400 EVO(10004761)

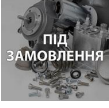
	27		NV01.013	FOOT BUFFER D.20 X H10 <i>FOOT BUFFER D.20 X H10</i>
	28		11003474	FS400 DOOR WHEEL <i>FS400 DOOR WHEEL</i>
	29		11006477	FS400 DOOR PIVOT FOR WHEEL <i>FS400 DOOR PIVOT FOR WHEEL</i>
	30		12000780	SCREW TSPC M4,0X20 UNI 7688 GALV. <i>SCREW TSPC M4,0X20 UNI 7688 GALV.</i>
	31		11033011	BASEBOARD ASSEMBLY <i>BASEBOARD ASSEMBLY</i>
	32		11000387	WEDGE FOR CHASSIS COVER <i>WEDGE FOR CHASSIS COVER</i>
	33		11032928	TOP ASSEMBLY FS4N <i>TOP ASSEMBLY FS4N</i>
	34		1863.034	CHANNEL FOR DOOR CABLES <i>CHANNEL FOR DOOR CABLES</i>
	35		NE16.002	GROMMET D.11X20,5XH.7 <i>GROMMET D.11X20,5XH.7</i>
	36		11008175	SPRING FOR UPPER DOOR CRISTALLO400 <i>SPRING FOR UPPER DOOR CRISTALLO400</i>
	37		1863.038	STIRRER UPPER DOOR <i>STIRRER UPPER DOOR</i>
	38		0875.113	BUSH FOR SLIDING PLATE <i>BUSH FOR SLIDING PLATE</i>
	39		U324.004	NUT M6 FLANGED INDENTED BASE <i>DADO M6 FLANGIATO BASE DENTELLATA</i>
	40		1863.071	PIN FOR CASING COVER <i>PERNO X COPERTURA CARCASSA</i>

Model Machine

MACSAE160

CRISTALLO 400 EVO(10004761)

	41		1863.073	DOOR SEAL FS400 <i>DOOR SEAL FS400</i>
	42		NV01.016	FOOT D.12 X H2,5 <i>FOOT D.12 X H2,5</i>
	43		1863.035.A20	SUPPORT FOR MICRO DOOR <i>SUPPORTO MICRO PORTA</i>
	44		NE05.039	BIPOLAR MICROSWITCH <i>MICROINTERRUTTORE BIPOLARE</i>
	44		NE05.061	MICROSWITCH CHERRY D413 .V3LD <i>MICROINT.BIPOLARE XTD 22AZ1</i>
	45		11032296	MICRO ROOF <i>MICRO ROOF</i>
	46		U116.006	SCREW AUT.PT TCB 3,5X12 WN 1441 ZNP <i>VITE AUT.PT TCB 3,5X12 WN 1441 ZNP</i>
	47		1863.016.A20	UPPER GUIDE LEFT PLATE <i>UPPER GUIDE LEFT PLATE</i>
	48		1863.017.A20	LOWER GUIDE LEFT PLATE <i>LOWER GUIDE LEFT PLATE</i>
	49		12002052	ZN-B TCB SCREW M4X16 <i>ZN-B TCB SCREW M4X16</i>
	50		12002042	BUCKET UTILPLASTIC 328X250X300BLACK <i>BUCKET UTILPLASTIC 328X250X300 BLACK</i>
	51		11032654	BOTTOM TUB <i>BOTTOM TUB</i>
	52		1863.018.A20	UPPER GUIDE RIGHT PLATE <i>UPPER GUIDE RIGHT PLATE</i>

Model Machine

MACSAE160

CRISTALLO 400 EVO(10004761)



53

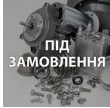

1863.019.A20

LOWER GUIDE RIGHT PLATE

LOWER GUIDE RIGHT PLATE



54



12002039

SCREW TCBD TORX 20 M4X12 ZN-B

VITE TCBD TORX 20 M4X12 ZN-B



55

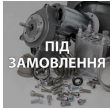

11027979

ROD LOCK HOOKUP SEAGA

AGGANCIO ASTA X SERRATURA A 3 PUNTI

Model Machine

MACSAE160

CRISTALLO 400 EVO(10004761)

MACSAE160.T.0002

TAVOLA NR. 2 - ARTICOLO CRISTALLO 400 EVO(10004761)

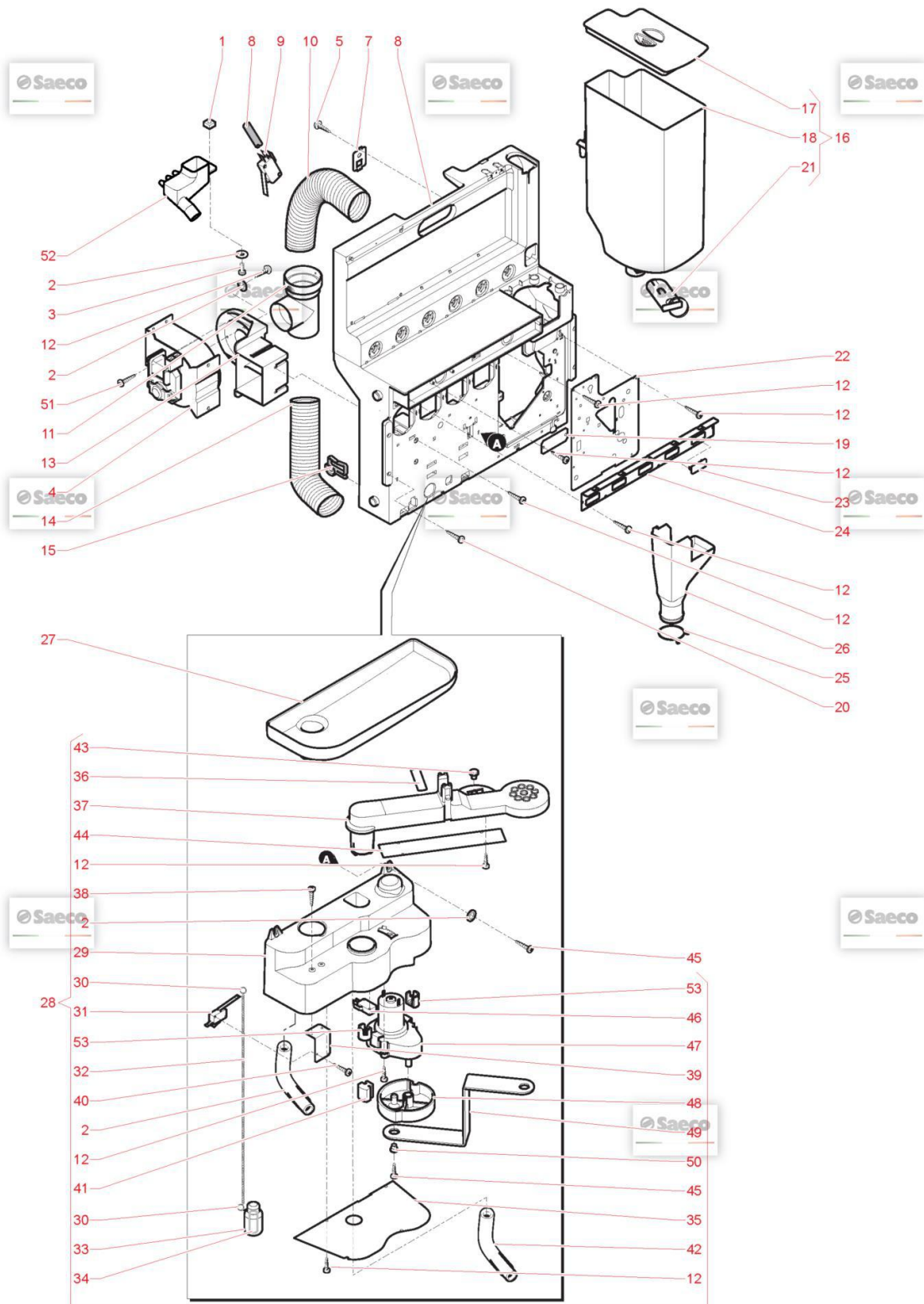

Model Machine

MACSAE160

CRISTALLO 400 EVO(10004761)

Web Pos. Foto Item - Replace by Description



Press - CTRL + CLICK go to item in a new window

Натисніть - Ctrl + права кнопка миші щоб відкрити запчастину в новому вікні



1



U315.001

NUT SQUARE M4 UNI 5596 GALV.
NUT SQUARE M4 UNI 5596 GALV.



2



U207.002

PLAIN WASHER 4,3X9 UNI 6592 GAL
ROSETTA PIANA 4,3X9 UNI 6592 ZNP



3

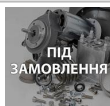

129825002

TCB SCREW M4X20 UNI 7687 ZNP
TCB SCREW M4X20 UNI 7687 ZNP



4



11003905

ВЕНТИЛЯТОР 120 VL
CENTRIFUGAL FAN 120V UL



4



9121.198.00A

ВЕНТИЛЯТОР ВИТЯЖКИ 07 120X100X100 SAECO 9121.198.00A
VENTILATORE CENTRIFUGO CAP 07



5

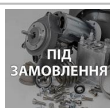

U110.003

SCREW AUT.TCB 3,5X9,5 DIN 7981F
VITE AUT.TCB 3,5X9,5 DIN 798



6

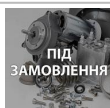

9111.708.A20

MAIN PLATE
PIASTRA PRINCIPALE



7

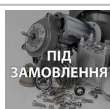

9111.766

CONNECTING PLATE
CONNECTING PLATE



8

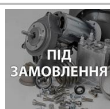

1883.004

SHEATH
SHEATH



9



NE05.018

MICROSWITCH
MICROINTERRUTTORE SAECO XCG5-81-P5



10

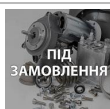

0862.014

ASPIRATOR TUBE L=290
ASPIRATOR TUBE L=290



11



9111.640.060

TUBE CONNECTOR
TUBE CONNECTOR



12



129670202

TCB PANELVIT SCREW 3,5X16 TESTA D=8 ZNP
TCB PANELVIT SCREW 3,5X16 TESTA D=8 ZNP

Model Machine

MACSAE160













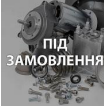

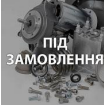







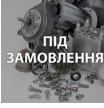

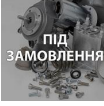
CRISTALLO 400 EVO(10004761)

	13		9111.732.A20	SUPPORT <i>SUPPORT</i>
	14		0862.145	SPIRAL TUBE L.210MM <i>SPIRAL TUBE L.210MM</i>
	15		9111.718	CLIP <i>CLIP</i>
	16		9110.139	COFFEE CONT. ASS. <i>ASS.CONTENTITORE CAFFE'</i>
	17		9111.728	COVER FOR COFFEE CONTAINER <i>COPERCHIO CONTENITORE CAFFE'</i>
	18		9111.724	CONTAINER FOR COFFEE BEAN <i>CONTENITORE CAFFE' IN GRANI</i>
	19		11000793	MIXER ASPIRATION PLATE <i>MIXER ASPIRATION PLATE</i>
	20		U023.009	SCREW TCEI M5,0X30 UNI 5931 8.8 B <i>SCREW TCEI M5,0X30 UNI 5931 8.8 B</i>
	21		11010736	ASS.GUILLOTINE COFFEE (1813.027) <i>ASS.GUILLOTINE COFFEE</i>
	22		9111.711	INOX. PLATE <i>INOX. PLATE</i>
	23		9111.481.060	COLUMN CAP <i>COLUMN CAP</i>
	24		9111.712	INOX. PLATE FOR MIXERS <i>INOX. PLATE FOR MIXERS</i>
	25		0862.112	GROUND SACK RING 8P <i>КОЛЬЦО ANELLO SACCO FONDI 8P</i>
	26		0862.111.050	GROUND DUCT <i>CONDOTTO X FONDI</i>

Model Machine

MACSAE160











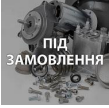















CRISTALLO 400 EVO(10004761)

	27		9111.714.A20	TANK TANK
	28		11033202	NOZZLE ARM NOZZLE ARM
	28		11033203	UL ASSEMBLED NOZZLES ARM UL ASSEMBLED NOZZLES ARM
	29		11033186	SUPPORT NOZZLE ARM SUPPORT NOZZLE ARM
	30		9111.148	ELASTIC RING FOR FLOAT ANELLO ELASTICO X GALLEGGIANTE
	31		NE05.041	MICROSWITCH MICROINTERRUTTORE
	32		9111.775	CHAIN CHAIN
	33		9111.130	FLOAT FOR DISCHARGE LEVEL FLOAT FOR DISCHARGE LEVEL
	34		9111.147	COUNTERWEIGHT FOR FLOAT CONTRAPPESO X GALLEGGIANTE
	35		9111.722	PLATE PIASTRA SUPPORTO BRACCIO
	36		140321560	O-RING 3187 NBR OR 3187 IN NBR
	37		9111.710.A20	NOZZLE ARM BRACCIO GIREVOLE
	38		129512903	SCREW TCB PH-AB 2,9X13 UNI 6954 NI SCREW TCB PH-AB 2,9X13 UNI 6954 NI

Model Machine

MACSAE160

CRISTALLO 400 EVO(10004761)

	39		9111.719	PLATE PLATE
	40		U109.003	SCREW TCB 3,5X9,5 DIN 7981 C NICK SCREW TCB 3,5X9,5 DIN 7981 C NICK
	41		0875.150	RUBBER FOR DISPENSING COMP. RUBBER FOR DISPENSING COMP.
	42		11001454	PVC TUBE 16X22 L.350 MM TUBO PVC 16X22 L.180MM
	43		NV01.009	RUBBER BUFFER GOMMINO PARACOLPI
	44		9111.723	PLATE PIASTRA X BRACCIO
	45		U116.002	SCREW AUT.PT TCB 3,5X16 WN 1441 SCREW AUT.PT TCB 3,5X16 WN 1441
	46		NE05.010	MICROSWITCH MICROINTERRUPTORE
	47		11033191	GEARMOTOR MECHTEX 25 RPM MOTORIDUTTORE MECHTEX 25 RPM
	48		9111.716.A20	CAM ARM CAMMA BRACCIO
	49		9111.715	CONNECTING ROD ARM BIELLA BRACCIO
	50		9111.204	BUSH FOR SPRING COMPENSATE STIRRER BOCCOLA X MOLLA BILANCERE PALETTE
	51		U109.005	SCREW AUT.TCB 3,5X16 DIN 7981C VITE AUT.TCB 3,5X16 DIN 798
	52		11030483	SYPHON SIFONE FORATO

Model Machine

MACSAE160

CRISTALLO 400 EVO(10004761)



53

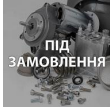

11033193

SPACER MOTOR ARM

SPACER MOTOR ARM

Model Machine

MACSAE160

CRISTALLO 400 EVO(10004761)

MACSAE160.T.0003

TAVOLA NR. 3 - ARTICOLO CRISTALLO 400 EVO(10004761)

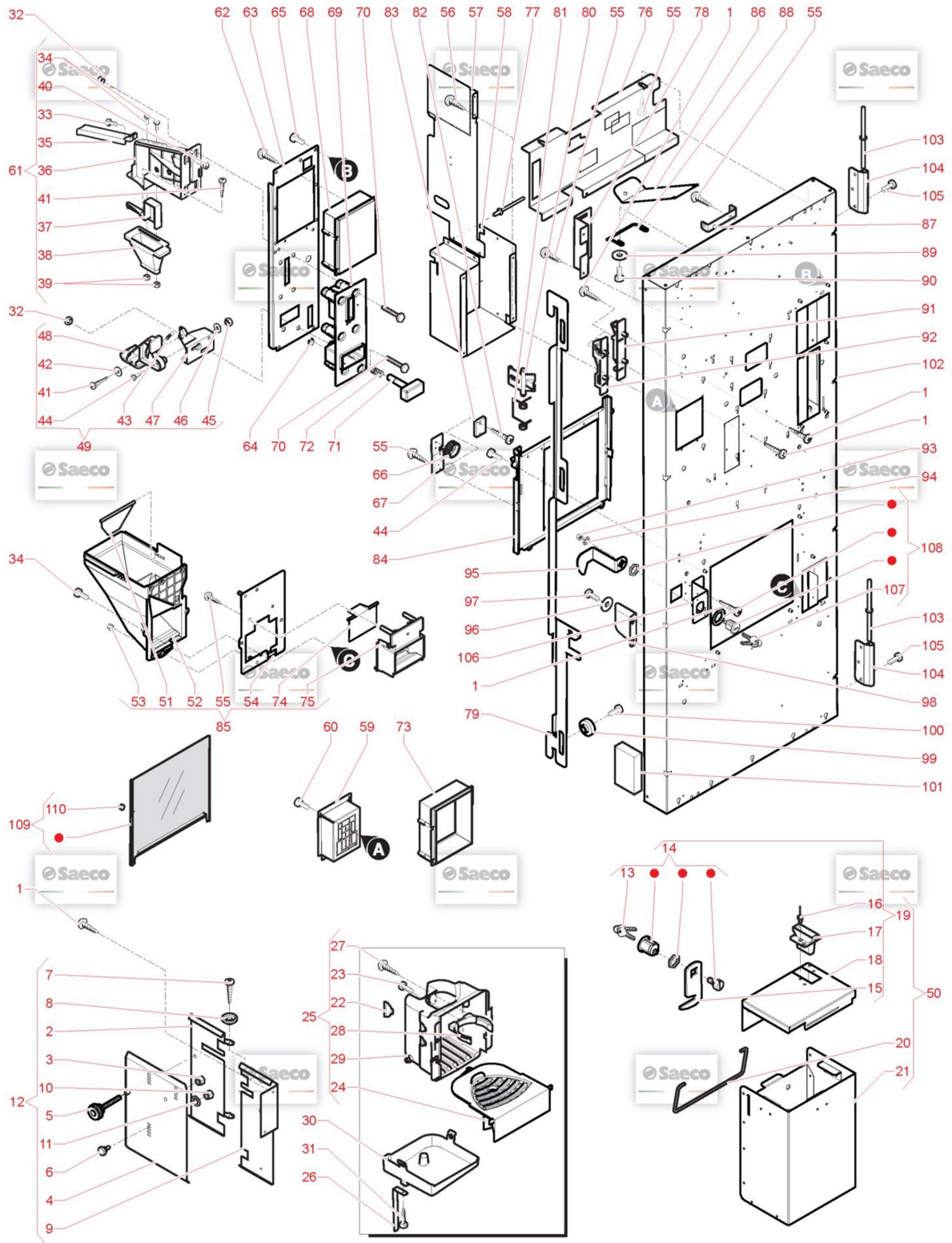

Model Machine

MACSAE160

CRISTALLO 400 EVO(10004761)

Web Pos. Foto Item - Replace by Description



Press - CTRL + CLICK go to item in a new window

Натисніть - Ctrl + права кнопка миші щоб відкрити запчастину в новому вікні



1

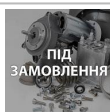

U110.002

SCREW AUT.TCB 3,5X13 DIN 7981F
SCREW AUT.TCB 3,5X13 DIN 7981 F



2

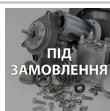

0875.365

SUP.COIN BOX
SUP.COIN BOX



3



123160502

GALVANIZED NUT M5 HIGH UNI 5587-68
GALVANIZED NUT M5 HIGH UNI 5587-68



4

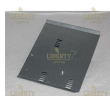

0875.357

ASS.FIXING PLATE COIN BOX
ASS.FIXING PLATE COIN BOX



5

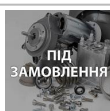

12002033

KNOB D.18 M5X25
KNOB D.18 M5X25



6



9111.614

COIN BOX ANCHORING PIN
COIN BOX ANCHORING PIN



7



U110.005

SCREW AUT.TCB 3,9X9,5 DIN 7981F
VITE AUT.TCB 3,9X9,5 DIN 798



8



1602.147

BUSH FOR DOOR CONNECTING ROD
BUSH FOR DOOR CONNECTING ROD



9

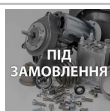

11032971

COIN BOX SUPPORT
COIN BOX SUPPORT



10



123160302

NUT M3 HIGH UNI 5587 GALVANIZED
NUT M3 HIGH UNI 5587 GALVANIZED



11

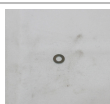

U207.003

PLAIN WASHER 3,2X7 UNI 6592 GALV.
PLAIN WASHER 3,2X7 UNI 6592 GALV.



12

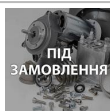

11032973

SUPPORT COIN BOX
ASS.SUPP.GETTONIERA RENDIRESTO FS4N



13

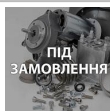













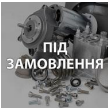



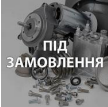





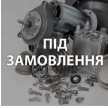



20007333

KEY MERONI 337
KEY MERONI 337

Model Machine

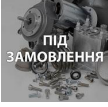
MACSAE160

























CRISTALLO 400 EVO(10004761)

	14		12001902	LOCK MERONI 337 <i>LOCK MERONI 337</i>
	15		11031071	LEVER FOR LOCK <i>LEVER FOR LOCK</i>
	16		NF11.026	EXPANSION RIVET D.3,9X8 ALU. <i>RIVETTO AD ESPANSIONE D.3,9X8 ALL.</i>
	17		11011665	COIN BOX HOPPER <i>COIN BOX HOPPER</i>
	18		11032960	COVER COIN BOX <i>COVER COIN BOX</i>
	19		11032962	COIN BOX CASE LID <i>COIN BOX CASE LID</i>
	20		0875.271	HANDLE FOR COIN CASE <i>HANDLE FOR COIN CASE</i>
	21		11032967	MONEY BOX ASSEMBLY <i>MONEY BOX ASSEMBLY</i>
	22		1863.013	LENS FOR COMPARTMENT DISPENSER <i>LENTE X VANO EROGAZIONE</i>
	23		U019.005	STEI SCREW M5,0X10 UNI 5923 GALV. <i>VITE STEI M5,0X10 UNI 5923 Z</i>
	24		11032880	FS4N GRILL <i>FS4N GRILL</i>
	25		11032969	DISPENSING COMPARTMENT FS4N <i>DISPENSING COMPARTMENT FS4N</i>
	26		1863.024	STIRRUP FOR COMPARTMENT DISPENSER <i>STAFFA X VANO EROGATORE</i>
	27		U109.022	SCREW AUT.TCB 4,2X13 DIN 7981C <i>SCREW AUT.TCB 4,2X13 DIN 7981 C</i>

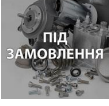
Model Machine

MACSAE160





























CRISTALLO 400 EVO(10004761)

	28		9111.368.050	VARIABLE CUP SUPPORT BLACK <i>SUPPORTO BICCHIERE VARIABILE</i>
	29		1863.012.050	COMPARTMENT DISPENSER <i>VANO EROGAZIONE</i>
	30		1863.023.050	WATER DRIP TRAY <i>VASCA X VANO EROGAZIONE</i>
	31		U109.023	SCREW AUT.TCB 4,2X9,5 DIN 7981C <i>SCREW AUT.TCB 4,2X9,5 DIN 7981 C</i>
	32		U324.003	NUT M5 FLANGED INDENTED BASE <i>NUT M5 FLANGED INDENTED BASE</i>
	33		U043.007	SCREW TCBC M3,0X8 UNI 7687 GALV. <i>SCREW TCBC M3,0X8 UNI 7687 GALV.</i>
	34		12002039	SCREW TCBD TORX 20 M4X12 ZN-B <i>VITE TCBD TORX 20 M4X12 ZN-B</i>
	35		11011663	SLIDE COVER COIN <i>SLIDE COVER COIN</i>
	36		11011616	COIN CHUTE <i>COIN CHUTE</i>
	37		11011618	БЛОК ДЛЯ КОНВЕЄРА МОНЕТ <i>BLOCCO X CONVOGLIATORE MONETE REGOLABILE</i>
	38		11012131	COIN CONVEYOR ADJUSTABLE FS400/600 <i>COIN CONVEYOR ADJUSTABLE FS400/600</i>
	39		U302.003	МЕТАЛЕВА ГАЙКА М4 UNI 5588 ZNP <i>DADO ESAGONALE M4 UNI 5588 ZNP</i>
	40		U302.002	NUT HEXAGONAL M3 UNI 5588 <i>NUT HEXAGONAL M3 UNI 5588</i>

Model Machine

MACSAE160











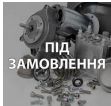



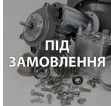

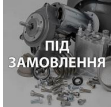

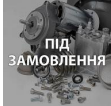



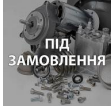

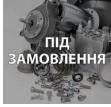

CRISTALLO 400 EVO(10004761)

	41		U116.005	SCREW AUT.PT TCB 3,0X8 WN 1441 VITE AUT.PT TCB 3,0X8 WN 1441 ZNP
	42		U212.006	WASHER 3,2X11X0,5 ZNP WASHER 3,2X11X0,5 ZNP
	43		9111.397	SPRING FOR TRAY /LEVER COIN RECOVE MOLLA X BACINELLA/LEVA RECUP
	44	 ПІД ЗАМОВЛЕННЯ	129825002	TCB SCREW M4X20 UNI 7687 ZNP TCB SCREW M4X20 UNI 7687 ZNP
	45		123453102	GALV.SELF LOCK NUT HIGH M4 DIN982 GALV.SELF LOCK NUT HIGH M4 DIN 982
	46	 ПІД ЗАМОВЛЕННЯ	U201.005	PLAIN WASHER 4,3X12 DIN 7349 GAL PLAIN WASHER 4,3X12 DIN 7349 GAL
	47		11011619	SUPPORT LEVER COIN RECOVERY SUPPORT LEVER COIN RECOVERY
	48		11011660	LEVER COIN RECOVERY LEVER COIN RECOVERY
	49		11011615	LEVER ASS. COIN RECOVERY LEVER ASS. COIN RECOVERY
	50	 ПІД ЗАМОВЛЕННЯ	11032968	ASSEMBLY COIN BOX ASSEMBLY COIN BOX
	51		11011662	ADJUSTABLE PLATE ADJUSTABLE PLATE
	52	 ПІД ЗАМОВЛЕННЯ	11032793	DUCT COIN RECOVERY FS4N CONDOTTO RECUPERO MONETE FS4N
	53		U324.004	NUT M6 FLANGED INDENTED BASE DADO M6 FLANGIATO BASE DENTELLATA
	54	 ПІД ЗАМОВЛЕННЯ	11033002	COIN RECOVER BRACKET FS4N COIN RECOVER BRACKET FS4N

Model Machine

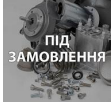
MACSAE160

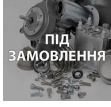





















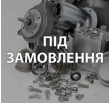

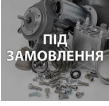
CRISTALLO 400 EVO(10004761)

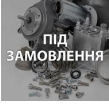
	55		U110.003	SCREW AUT.TCB 3,5X9,5 DIN 7981F <i>VITE AUT.TCB 3,5X9,5 DIN 798</i>
	56		U110.004	SCREW AUT.TCB 3,5X6,5 DIN 7981F <i>VITE AUT.TCB 3,5X6,5 DIN 7981 F NIK</i>
	57		11033723	COIN BOX BRACKET FS4N <i>PIASTRA PROTEZIONE GETTONIERA FS4N</i>
	58		11033000	COIN BOX BRACKET FS4N <i>PIASTRA SUPP.CASSA MONETE FS4N</i>
	59		11032996	BRACKET FOR BANKNOTE READER <i>BRACKET FOR BANKNOTE READER</i>
	60		U127.011	SCREW TAPT.TCB M5,0X8 DIN 7500C <i>SCREW TAPT.TCB M5,0X8 DIN 7500C</i>
	61		11011614	ASS.SCIVOLO MONETE CRISTALLO400 <i>ASS.SCIVOLO MONETE CRISTALLO400</i>
	62		U142.008	PANELVIT TSP 3,5X12 DIN 7505 AGAL <i>PANELVIT TSP 3,5X12 DIN 7505 A GAL</i>
	63		11032985	PLATE COIN RAMP FS4N <i>PLATE COIN RAMP FS4N</i>
	64		U701.003	SNAP RING 7 UNI 7434 <i>ANELLO ELASTICO 7 UNI 7434</i>
	65		129824002	TCB SCREW M4X10 UNI 7687 ZNP <i>VITE TCB M4X10 UNI 7687 ZNP</i>
	66		11034002	ASSEMBLY DAMPER+GEAR Z.21 <i>ASSEMBLY DAMPER+GEAR Z.21</i>
	67		11033871	SLOW DOWN BRACKET CRS EVO <i>SLOW DOWN BRACKET CRS EVO</i>
	68		11032946	СЕРМЕНТ БАНКНОТОПРИЙМАЧА FS4N <i>BANKNOTE READER CAP FS4N</i>

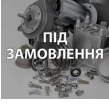
Model Machine

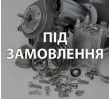
MACSAE160











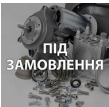

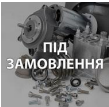

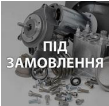











CRISTALLO 400 EVO(10004761)

	69		11032756	РАМКА ДЛЯ ВСТАВЛЯННЯ МОНЕТ ТА ПІД СІРУ КНОПКУ FS4N <i>CORNICE INTRO.MONETE E TASTO GRY FS4N</i>
	70		U005.018	SCREW TE M5,0X16 UNI 5739 ZNP8.8 <i>VITE TE M5,0X16 UNI 5739 ZNP</i>
	71		11032783	КНОПКА ПОВЕРНЕННЯ МОНЕТ FS4N <i>PUSH BUTTON FS4N</i>
	72		9111.355	SPRING FOR CHANGE BUTTON <i>MOLLA X PULSANTE RENDIRESTO</i>
	73		11032782	BANKNOTE READER FRAME FS4N <i>BANKNOTE READER FRAME FS4N</i>
	74		11032785	CHANGE DOOR FS4N <i>SPORTELLO RENDIRESTO FS4N</i>
	75		11032755	FRAME FOR COIN RECOVERY FS4N <i>FRAME FOR COIN RECOVERY FS4N</i>
	76		11032886	CARD PROTECTION CPU <i>PROTEZIONE SCHEDA CPU</i>
	77		12000962	MULTIGRIP RIVETS 4.8X11 <i>MULTIGRIP RIVETS 4.8X11</i>
	78		11033303	BRACKET TOUCH PANEL <i>BRACKET TOUCH PANEL</i>
	79		11033780	ROD FOR LOCK <i>ROD FOR LOCK</i>
	80		9111.372.050	DISP. COMPARTM. LOCKING LEVERBLAC <i>LEVA FERMO VANO EROGAZIONE NERO</i>
	81		9111.373	SPRING FOR DISP. COMP. RETAINING <i>MOLLA X FERMO VANO EROGAZ.</i>

Model Machine

MACSAE160





























CRISTALLO 400 EVO(10004761)

	82		U110.011	SCREW AUT.TCB 2,9X9,5 DIN 7981F <i>SCREW AUT.TCB 2,9X9,5 DIN 7981 F</i>
	83		1863.649	REED FOR DOOR <i>REED FOR DOOR</i>
	84		11032791	DISPENSER VAIN SUPPORT FS4N <i>DISPENSER VAIN SUPPORT FS4N</i>
	85		11033004	COIN REVOVER ASSEMBLY <i>ASS.RECUPERO MONETE</i>
	86		11032947	COVER GLASSES FRAME FS4N <i>COVER GLASSES FRAME FS4N</i>
	87		0894.185	BASKET STOP BRACKET <i>BASKET STOP BRACKET</i>
	88		11007640	SPRING FOR UPPER DOOR MICROSWITCH <i>SPRING FOR UPPER DOOR MICROSWITCH</i>
	89		U207.002	PLAIN WASHER 4,3X9 UNI 6592 GAL <i>ROSETTA PIANA 4,3X9 UNI 6592 ZNP</i>
	90		U043.006	SCREW TCBC M4,0X14 UNI 7687 GALV. <i>SCREW TCBC M4,0X14 UNI 7687 GALV.</i>
	91		1863.033.A20	CUP DISTR. SUPPORT <i>SUPPORTO DISTRIBUTORE BICCH.DX</i>
	92		1863.032.A20	CUP DISTR. SUPPORT <i>SUPPORTO DISTRIBUTORE BICCH.SX</i>
	93		U302.006	NUT HEXAGONAL M10 UNI 5588 <i>DADO ESAGONALE M10 UNI 5</i>
	94		U208.008	TOOTHED WASHER 10,5X18 UNI 3703 G <i>ROSETTA DENT. 10,5X18 UNI 3</i>
	95		11033781	LEVER LOCK <i>LEVER LOCK</i>

Model Machine

MACSAE160

CRISTALLO 400 EVO(10004761)

	96		U207.001	PLAIN WASHER 5,3X10 UNI 6592 GAL <i>ROSETTA PIANA 5,3X10 UNI 6</i>
	97		U043.015	SCREW TCBC M5,0X12 UNI 7687 GALV. <i>SCREW TCBC M5,0X12 UNI 7687 GALV.</i>
	98		11003448	MOVABLE PLATE FOR FS400 DOOR <i>MOVABLE PLATE FOR FS400 DOOR</i>
	99		11008644	LOCK PIN <i>LOCK PIN</i>
	10001		U046.001	SCREW TEFZ M5,0X16 UNI 6921 GALV. <i>SCREW TEFZ M5,0X16 UNI 6921 GALV.</i>
	1010		11000390	OUTDISTANCE FOR FS400 DOOR <i>OUTDISTANCE FOR FS400 DOOR</i>
	1020		11033842	ASSEMBLY FRONT DOOR CRS400 EVO <i>ASS.PORTA ANTERIORE RIVETTATA CRS400 EVO</i>
	1030		11032805	PIN HINGE FS4N <i>PERNO CERNIERA FS4N</i>
	1040		11033875	LOWER DOOR CRS EVO BLK <i>CERNIERA PORTA CRS EVO BLK</i>
	1050		U044.002	SCREW TSPC M4,0X10 UNI 7688 GALV. <i>SCREW TSPC M4,0X10 UNI 7688 GALV.</i>
	1060		11032998	BRACKET FOR LOCK <i>PIASTRA SUPP.SERRATURA FS4N</i>
	1070		NV02.243	KEY RIELDA AJ306A <i>KEY RIELDA AJ306A</i>
	1080		NV02.229	LOCK RIELDA MOD.512 + KEY <i>LOCK RIELDA MOD.512 + KEY</i>
	1090		11033747	CUP STATION'S DOOR <i>CUP STATION'S DOOR</i>

Model Machine

MACSAE160

CRISTALLO 400 EVO(10004761)



1100



9991.093

MAGNET D=9,5 X H=1,5

MAGNETE D.9,5 X 1,5

Model Machine

MACSAE160

CRISTALLO 400 EVO(10004761)

MACSAE160.T.0004

TAVOLA NR. 4 - ARTICOLO CRISTALLO 400 EVO(10004761)

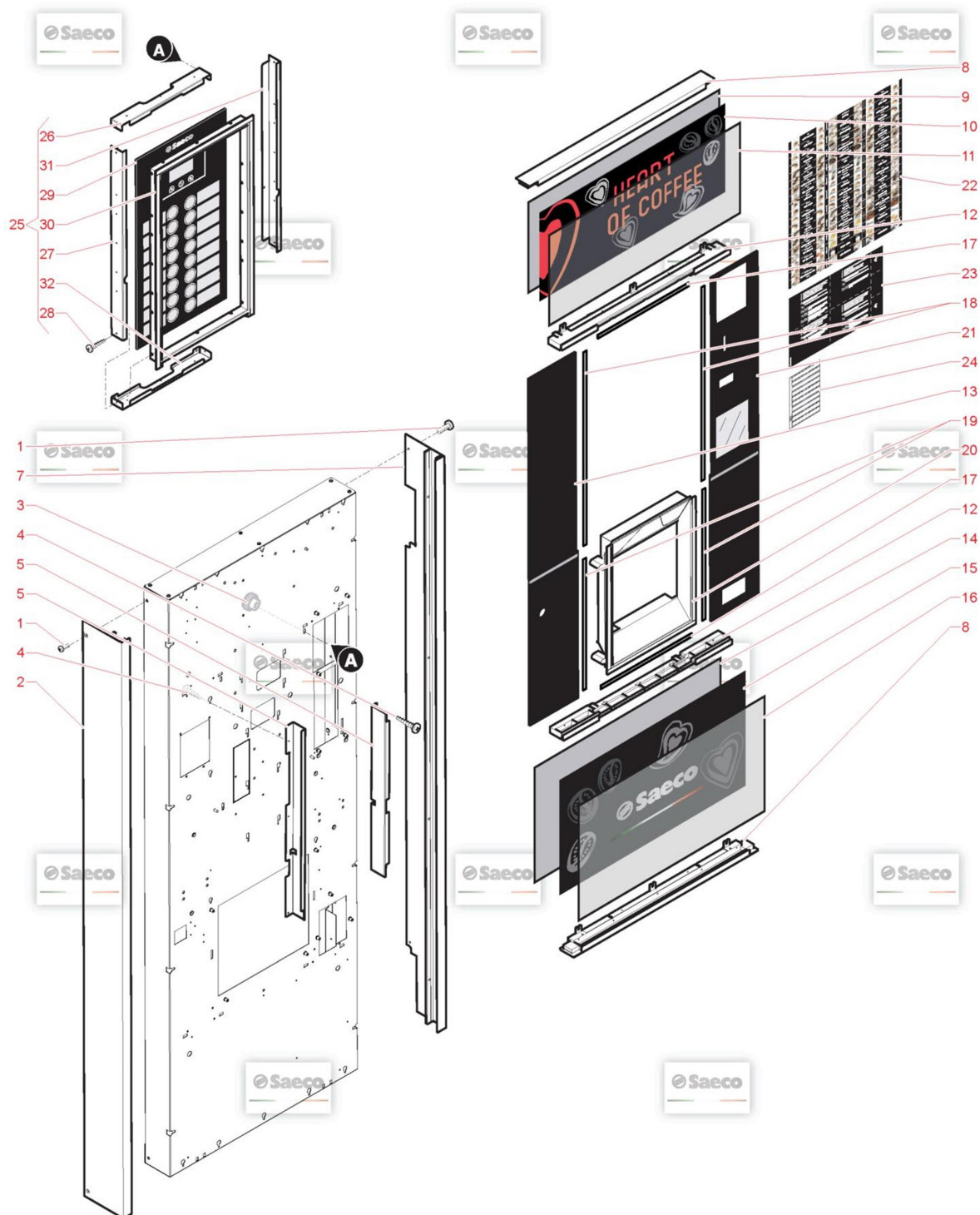

Model Machine

MACSAE160

CRISTALLO 400 EVO(10004761)

Web Pos. Foto Item - Replace by Description



Press - CTRL + CLICK go to item in a new window

Натисніть - Ctrl + права кнопка миші щоб відкрити запчастину в новому вікні



1

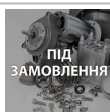

U044.002

SCREW TSPC M4,0X10 UNI 7688 GALV.
SCREW TSPC M4,0X10 UNI 7688 GALV.



2

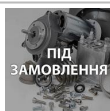

11032883

LEFT OUTLINE SIDE FS4N
LEFT OUTLINE SIDE FS4N



3



12002034

KNOB WITH BUSH M5
KNOB WITH BUSH M5



4

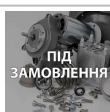

U110.003

SCREW AUT.TCB 3,5X9,5 DIN 7981F
VITE AUT.TCB 3,5X9,5 DIN 798



5

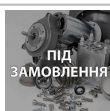

11032978

LEFT TRACK FOR LEXAN FS4N
LEFT TRACK FOR LEXAN FS4N



6

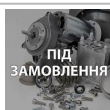

11032976

RIGHT TRACK FOR LEXAN FS4N
RIGHT TRACK FOR LEXAN FS4N



7

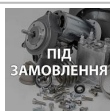

11033881

RIGHT OUTLINE SIDE CRS400 EVO
RIGHT OUTLINE SIDE CRS400 EVO



8

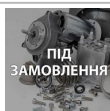

11032788

UPPER/LOWER OUTLINE FSN4
UPPER/LOWER OUTLINE FSN4



9

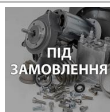

11033818

UPPER LEXAN CRS400 EVO
LEXAN SUPERIORE OPALINO CRS400 EVO



10

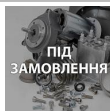

11032881

UPPER IMAGE CRISTALLO400 EVO
UPPER IMAGE CRISTALLO400 EVO



10

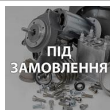

11033370

UPPER ADVERTISING CRISTALLO400EVO CAPS
TARGA SUPERIORE CRISTALLO400 EVO CAPS



10

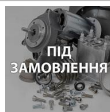

11034328

UPPER IMAGE CRS400 EVO CAPS COVIM
UPPER IMAGE CRS400 EVO CAPS COVIM



10















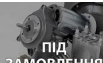



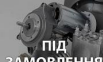









11034334

UPPER IMAGE CRS400 EVO CAPS CAFFITALY
UPPER IMAGE CRS400 EVO CAPS CAFFITALY

Model Machine

MACSAE160

















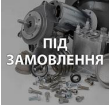





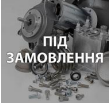

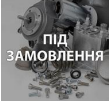
CRISTALLO 400 EVO(10004761)

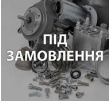
	11		11032795	ПЕРЕДНЯ ПАНЕЛЬ ПРОЗОРА FS4N <i>LEXAN SUPERIORE FS4N</i>
	12		11032787	CENTRAL OUTLINE FS4N <i>CENTRAL OUTLINE FS4N</i>
	13		11032797	LEFT SIDE LEXAN FS4N <i>LEXAN LATERALE SX FS4N</i>
	14		11033817	LOWER LEXAN CRS EVO <i>LOWER LEXAN CRS EVO</i>
	15		11033369	LOWER ADVERTISING PLATE CRISTALLO EVO <i>TARGA INFERIORE CRISTALLO EVO CAPS</i>
	15		11033784	LOWER IMAGE CRS H.342 <i>LOWER IMAGE CRS H.342</i>
	15		11034329	LOWER IMAGE CRS EVO CAPS COVIMITA <i>LOWER IMAGE CRS EVO CAPS COVIM ITA</i>
	15		11034335	LOWER IMAGE CRS EVO CAPS CAFFITALY <i>LOWER IMAGE CRS EVO CAPS CAFFITALY</i>
	15		11034506	LOWER IMAGE CRS EVO CAPS COVIMFRA <i>LOWER IMAGE CRS EVO CAPS COVIMFRA</i>
	16		11032796	LOWER LEXAN CRS EVO <i>LEXAN INFERIORE CRS EVO</i>
	17		11033293	STICKY FILLET 291,1 X 9,5 X 0,8 <i>STICKY FILLET 291,1 X 9,5 X 0,8</i>
	18		11033295	STICKY FILLET 506,8 X 9,5 X 0,8 <i>STICKY FILLET 506,8 X 9,5 X 0,8</i>
	19		11033294	STICKY FILLET 354,3 X 9,5 X 0,8 <i>STICKY FILLET 354,3 X 9,5 X 0,8</i>
	20		11032790	DISPENSER FRAME VAIN FS4N <i>CORNICE VANO EROGAZIONE FS4N</i>

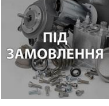
Model Machine

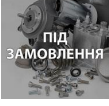
MACSAE160











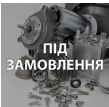

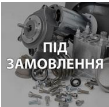

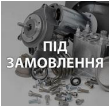











CRISTALLO 400 EVO(10004761)

	21		11033810	RIGHT SIDE LEXAN CRS400 EVO <i>LEXAN LATERALE DX CRS400 EVO</i>
	22		15004381	ТАБЛИЧКА З НАЗВАМИ НАПОЇВ ІТА <i>FOGLIO ETICH.PROD.TAST.CAPACITIVA ITA</i>
	22		15004382	PRODUCTS LABEL'S SHEET CRISTALLO EVO ENG <i>PRODUCTS LABEL'S SHEET CRISTALLO EVO ENG</i>
	22		15004383	PRODUCTS LABEL'S SHEET CRISTALLO EVO FRA <i>PRODUCTS LABEL'S SHEET CRISTALLO EVO FRA</i>
	22		15004384	PRODUCTS LABEL'S SHEET CRISTALLO EVO DE <i>PRODUCTS LABEL'S SHEET CRISTALLO EVO DE</i>
	22		15004385	PRODUCTS LABEL'S SHEET CRISTALLO EVO SPA <i>PRODUCTS LABEL'S SHEET CRISTALLO EVO SPA</i>
	22		15004386	PRODUCTS LABEL'S SHEET CRISTALLO EVO POR <i>FOGLIO ETICH.PROD.TAST.CAPACITIVA POR</i>
	22		15004387	PRODUCTS LABEL'S SHEET CRISTALLO EVO NL <i>PRODUCTS LABEL'S SHEET CRISTALLO EVO NL</i>
	22		15004540	PRODUCTS LABEL'S SHEET CRS EVOITA <i>PRODUCTS LABEL'S SHEET CRS EVOITA</i>
	22		15004611	PRODUCTS LABEL'S SHEET CRS EVOCOVIM FRA <i>PRODUCTS LABEL'S SHEET CRS EVO COVIM FRA</i>
	22		15004612	PRODUCTS LABEL'S SHEET CRS EVOCOVIM SPA <i>PRODUCTS LABEL'S SHEET CRS EVOCOVIM SPA</i>
	22		15004613	PRODUCTS LABEL'S SHEET CRS EVOCOVIM POR <i>PRODUCTS LABEL'S SHEET CRS EVOCOVIM POR</i>
	23		15004037	INSTRUCTION LABEL CRISTALLO C.B ITA <i>INSTRUCTION LABEL CRISTALLO C.B ITA</i>

Model Machine

MACSAE160

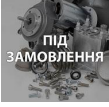
CRISTALLO 400 EVO(10004761)

	23		15004038	INSTRUCTION LABEL CRISTALLO C.B FRA <i>INSTRUCTION LABEL CRISTALLO C.B FRA</i>
	23		15004039	INSTRUCTION LABEL CRISTALLO C.B DE <i>INSTRUCTION LABEL CRISTALLO C.B DE</i>
	23		15004040	INSTRUCTION LABEL CRISTALLO C.B POR <i>INSTRUCTION LABEL CRISTALLO C.B POR</i>
	23		15004041	INSTRUCTION LABEL CRISTALLO C.B ESP <i>INSTRUCTION LABEL CRISTALLO C.B ESP</i>
	23		15004042	INSTRUCTION LABEL CRISTALLO C.B NL <i>INSTRUCTION LABEL CRISTALLO C.B NL</i>
	23		15004043	INSTRUCTION LABEL CRISTALLO C.B ENG <i>INSTRUCTION LABEL CRISTALLO C.B ENG</i>
	24		0775.989	PRICE LABELS WHITE EURO <i>PRICE LABELS WHITE EURO</i>
	25		11032874	CAPACITIVE INTERFACE <i>CAPACITIVE INTERFACE</i>
	26		11032866	UPPER ANGULAR FRAME <i>UPPER ANGULAR FRAME</i>
	27		11032862	LEFT ANGULAR FRAME <i>LEFT ANGULAR FRAME</i>
	28		12002160	SCREW TMTPH2 3,5X9,5 F ZNP ISO4759/1 <i>SCREW TMTPH2 3,5X9,5 F ZNP ISO4759/1</i>
	29		11032867	CAPACITIVE KEYBOARD <i>CAPACITIVE KEYBOARD</i>
	30		11032789	INTERFACE FRAME FS4N <i>INTERFACE FRAME FS4N</i>
	31		11032861	RIGHT ANGULAR FRAME <i>RIGHT ANGULAR FRAME</i>

Model Machine

MACSAE160

CRISTALLO 400 EVO(10004761)



32

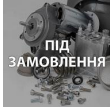

11032863

LOWER ANGULAR FRAME

LOWER ANGULAR FRAME

Model Machine

MACSAE160

CRISTALLO 400 EVO(10004761)

MACSAE160.T.0005

TAVOLA NR. 5 - ARTICOLO CRISTALLO 400 EVO(10004761)

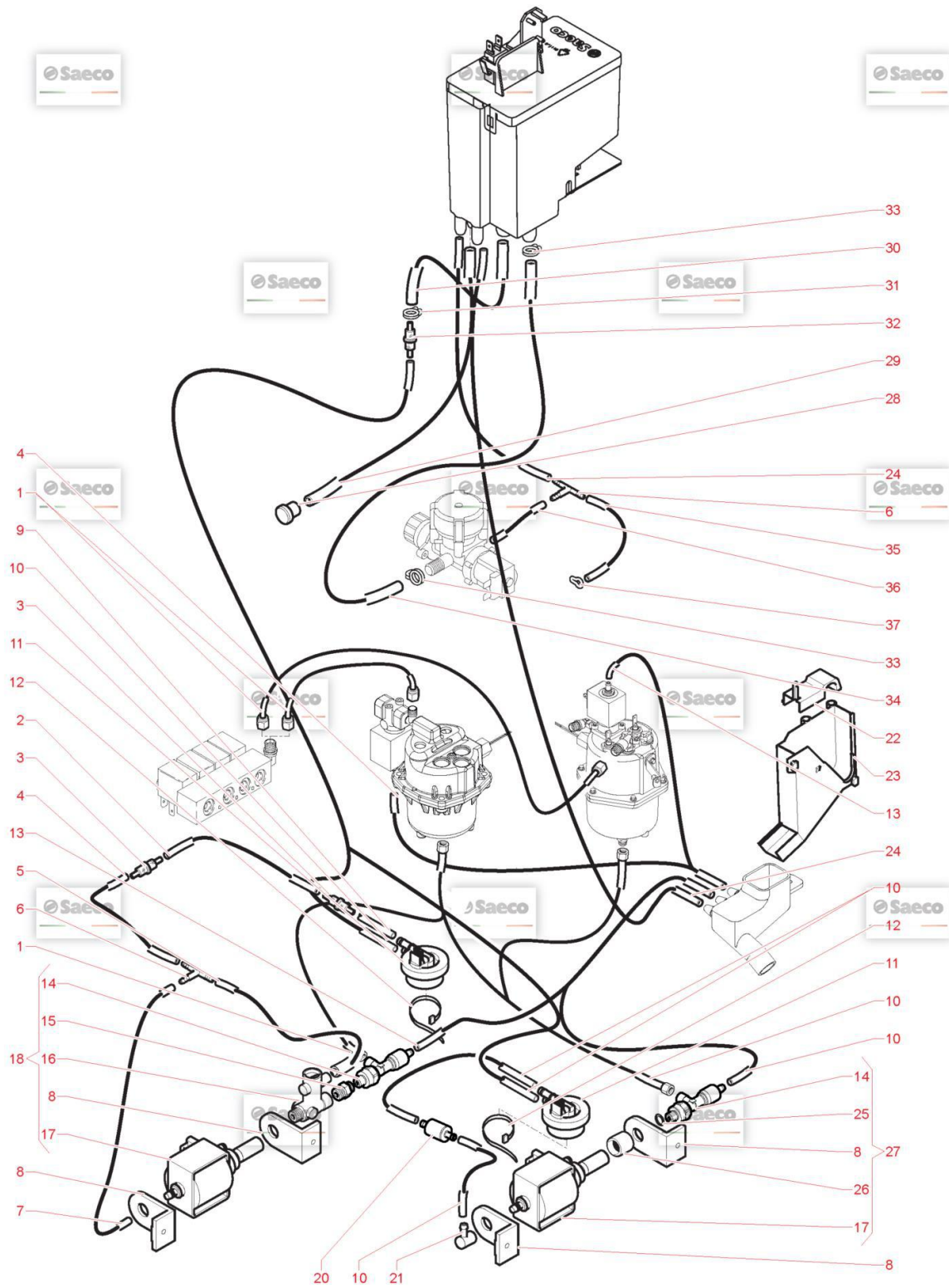

Model Machine

MACSAE160

CRISTALLO 400 EVO(10004761)

Web Pos. Foto Item - Replace by Description



Press - CTRL + CLICK go to item in a new window



















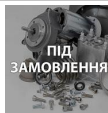

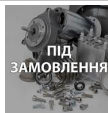



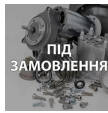

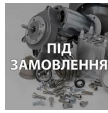
Натисніть - Ctrl + права кнопка миші щоб відкрити запчастину в новому вікні

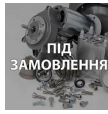
	1		11025295	TEFLON TUBE 3X6 L.170 1/8"-1/8 <i>TEFLON TUBE 3X6 L.170 1/8-1/8</i>
	2		11028368	TUBO SILICONE 5X10 L.190MM <i>TUBO SILICONE 5X10 L.190MM</i>
	3		11032038	FILTER INTAKE IN LUNG WATER SUPPLY <i>FILTRO POLMONE IN ASPIRAZ.RETE IDRICA</i>
	4		9972.087	SILICONE TUBE 5X10 L.300MM <i>SILICONE TUBE 6X9 L.330 MM</i>
	5		9972.073	SILICONE TUBE 7X11 L. 220MM <i>SILICONE TUBE 8X12 L. 220 MM</i>
	6		NV99.004	CONNECTOR T MORONI 8026047 D=8 <i>CONNECTOR T MORONI 8026047 D=8</i>
	7		9972.208	SILICONE TUBE 5X10 L.55MM <i>SILICONE TUBE 5X10 L.55MM</i>
	8		149185850	ТРИМАЧ (ГУМОВИЙ)ПОМПИ ДЛЯ КАВОМАШИН SAECO MAGIC 4002012 (...) <i>SUPPORTO POMPA EATON MAGIC 4</i>
	9		9972.195	SILICONE TUBE 5X10 L.250MM <i>SILICONE TUBE 5X10 L.250MM</i>
	10		9972.246	СИЛІКОНОВА ТРУБКА 5X10 SAECO 265918 (2 МЕТРИ) <i>TUBO SILICONE 5X10 L.2000 MM</i>
	11		NV99.099	TURBINE D=1,2 ASSY. <i>TURBINA DIGMESA FHKSC 1,2 ARNITE OC</i>
	12		144320200	SELF LOCK STRIP W=2.6 L=200 <i>SELF LOCK STRIP W=2.6 L=200</i>
	13		9972.115	SILICONE TUBE 5X10 L.230MM <i>SILICONE TUBE 5X10 60SH L=230 MM</i>

Model Machine

MACSAE160





















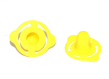

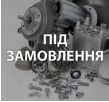

CRISTALLO 400 EVO(10004761)

	14		11005590	SAFETY VALVE/NON RETURN ASS. NEW <i>ASS.VALVOLA SICUREZZA/NON RI</i>
	15		11032615	FITTING ADAPTER VALVE <i>FITTING ADAPTER VALVE</i>
	16		20007360	ОБХІДНИЙ КЛАПАН FLUID-O-TECH B7E <i>BYPASS VALVE FLUID-O-TECH B7E</i>
	17		9070.042.00A	ULKA НАСОС (ПОМПА) EX5GW 230/240V 50HZ SD1 БЬЯНКО 15 BAR <i>ULKA PUMP EX5 SD1</i>
	17		9070.042.00N	PUMP 220V <i>ULKA PUMP EX5 SD1</i>
	17		9070.044.00F	PUMP 120V-60HZ <i>ULKA PUMP EP5 D1</i>
	18		11033578	ASSMEBLY PUMP EX5 SD1 230V <i>ASSMEBLY PUMP EX5 SD1 230V</i>
	18		11033749	ASSMEBLY PUMP EX5 SD1 220V <i>ASSMEBLY PUMP EX5 SD1 220V</i>
	19		11025292	TEFLON TUBE 3X6 L.230 1/8"-1/8 <i>TEFLON TUBE 3X6 L.230 1/8"-1/8</i>
	20		11024178	WATER FILTER PHEDRA <i>WATER FILTER PHEDRA</i>
	21		147920150	90° INLET PUMP CONNECTOR <i>RACCORDO A 90° IN SANTOPRENE</i>
	22		9161.262.060	DRIP CHANNEL COVER <i>COPERTURA CANALINO RACCOGLIGOCCE</i>
	23		9111.597.050	COFFEE DISCHARGE CHANNEL SHORT <i>CANALINO SCARICO CAFFE' CORTO</i>
	24		9972.336	SILICONE TUBE 5X10 L.580MM <i>SILICONE TUBE 5X10 L.580MM</i>

Model Machine

MACSAE160

CRISTALLO 400 EVO(10004761)

	25		140321961	ПРОКЛАДКА O-RING ДЛЯ КАВОМАШИНИ SAECO 2031 TERMOIL OR 2031 IN TERMOIL
	26		9071.098	REINFORCEMENT FOR ULKA PUMP REINFORCEMENT FOR ULKA PUMP
	27	 ПІД ЗАМОВЛЕННЯ	9070.043.00A	ULKA PUMP+NON RETURN ULKA PUMP EX5 SD1 +NON RETURN
	27	 ПІД ЗАМОВЛЕННЯ	9070.043.00N	PUMP+NON RETURN ULKA PUMP EX5 SD1 +NON RETURN
	27	 ПІД ЗАМОВЛЕННЯ	9070.045.00F	PUMP 120V ULKA PUMP ASS.EP5 D1 120V
	28		NV03.006	CAP KAPSTO LPN 615/010 TAPPO KAPSTO LPN 615/010
	29		9972.335	SILICONE TUBE 7X11 L.135MM TUBO SILICONE 7X11 L.1240 MM
	30	 ПІД ЗАМОВЛЕННЯ	9972.141	SILICONE TUBE 7X11 L.160MM SILICONE TUBE 7X11 L.160 MM
	31		NV99.072	HOSE CLAMP D. 11.6/12.3 HOSE CLAMP D. 11.6/12.3
	32		144650300	ФІЛЬТР ОЧИСТКИ ВОДИ ДЛЯ КАВОМАШИНИ SAECO NEW (NV99.001) (88... ASPIRATION FILTER GAUZE NET 500 (NEW)
	33		NV99.050	HOSECLAMP D. 13.3/14.1 HOSECLAMP D. 13.3/14.1
	34	 ПІД ЗАМОВЛЕННЯ	9972.312	SILICONE TUBE 7X11 L.960MM SILICONE TUBE 7X11 L.960MM
	35	 ПІД ЗАМОВЛЕННЯ	11013436	SILICONE TUBE 5X10 L.650MM SILICONE TUBE 5X10 L.650MM

Model Machine

MACSAE160

CRISTALLO 400 EVO(10004761)



36

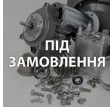

9972.265

SILICONE TUBE 5X10 L.170MM

SILICONE TUBE 6X9 L.170 MM



37



9111.141

DISCHARGE TUBE CLOSURE SPRING

DISCHARGE TUBE CLOSURE SPRING

Model Machine

MACSAE160

CRISTALLO 400 EVO(10004761)

MACSAE160.T.0006



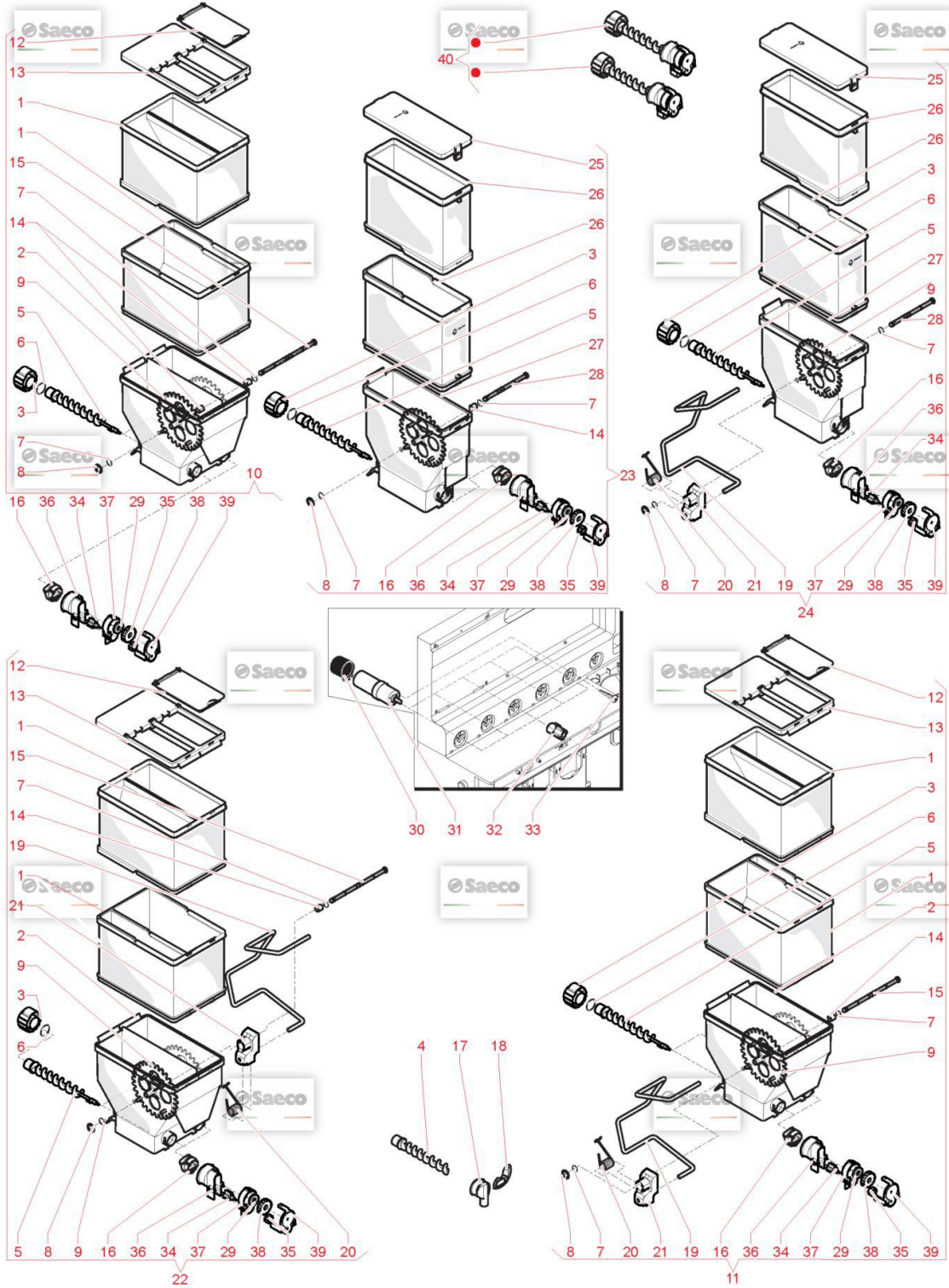























TAVOLA NR. 6 - ARTICOLO CRISTALLO 400 EVO(10004761)



Model Machine

MACSAE160











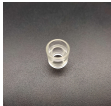















CRISTALLO 400 EVO(10004761)

Web	Pos.	Foto	Item - Replace by	Description
				<i>Press - CTRL + CLICK go to item in a new window Натисніть - Ctrl + права кнопка миші щоб відкрити запчастину в новому вікні</i>
	1		9111.681	DOUBLE EXTENSION 145 <i>PROLUNGA DOPPIA 145</i>
	2		9111.680	BASE CONTAINER DOUBLE SOLUBLE <i>BASE CONTENITORE SOLUBILI DOPPIO</i>
	3		11012130	BACK BUSH REINFORCE <i>BACK BUSH REINFORCE</i>
	4		9111.701	SCROLL SCREW DOUBLE CONTAINER <i>COCLEA CONTENITORE DOPPIO</i>
	5		11005180	SCROLL SCREW FOR NEW DISPENSER APERTURE <i>COCLEA X BOCCHETTA EROGAZIONE APERTURE SCROLL SCREW FOR ...</i>
	6		NM03.013	OR 2,3X15 NBR <i>OR 2,3X15 NBR</i>
	7		NM03.022	OR ORM 0060-10 NBR <i>OR ORM 0060-10 NBR</i>
	8		U701.003	SNAP RING 7 UNI 7434 <i>ANELLO ELASTICO 7 UNI 7434</i>
	9		9111.702	WHEEL DOUBLE CONTAINER <i>RUOTA CONTENITORE DOPPIO</i>
	10		11031891	ASSEMBLED DOUBLE TANK EASY DRY2 <i>ASSEMBLED DOUBLE TANK EASY DRY 2</i>
	11		11031885	PHEDRA ASSEMBLED DOUBLE TANK <i>PHEDRA ASSEMBLED DOUBLE TANK</i>
	12		9111.683	SOLUBLE COVER <i>COPERCHIETTO SOLUBILI</i>
	13		9111.682	COVER CONTAINER DOUBLE SOLUBLE <i>COPERCHIO CONT.SOLUBILI DOPPIO</i>

Model Machine

MACSAE160























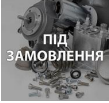

CRISTALLO 400 EVO(10004761)

	14		11032945	SPACE FOR GEAR BPA FREE <i>SPACE FOR GEAR BPA FREE</i>
	15		9111.703	DOUBLE PIN FOR WHEEL <i>PERNO DOPPIA PER RUOTA</i>
	16		11028378	FRONT BUSH <i>FRONT BUSH</i>
	17		9111.629.060	APERTURE FOR SOLUBLES HOPPER <i>APERTURE FOR SOLUBLES HOPPER</i>
	18		9111.338.270	BULKHEAD FOR APERT. CLOSURE ORANGE <i>PARATIA CHIUSURA BOCCHETTA ARANCIO</i>
	19		11006124	WIRE AGITATOR UNIFIED <i>FILO AGITATORE UNIFICATO WIRE AGITATOR UNIFIED</i>
	20		9111.731	SPRING <i>MOLLA AGITATORE</i>
	21		11007155	ПЛАСТИКОВИЙ ТРИМАЧ ВЗБИВАЛКИ SAECO 9111.735 <i>AGITATOR SUPPORT</i>
	22		11031888	ASSEMBLED DOUBLE TANK <i>ASSEMBLED DOUBLE TANK</i>
	23		11031883	ASSEMBLY SINGLE CONTAINER <i>ASSEMBLY SINGL CONTAINER</i>
	24		11031886	ASSEMBLY SINGLE CONTAINER <i>ASSEMBLY SINGLE CONTAINER</i>
	25		11001578	COVER CONTAINER SINGLE SOLUBLE <i>COPERCHIO CONTENITORE SOLUBILE SINGOLO</i>
	26		11001577	EXTENSION CONTAINER SINGLE SOLUBLE <i>PROLUNGA CONTENITORE SOLUBILE SINGOLO</i>
	27		11001576	BASE CONTAINER SINGLE SOLUBLE <i>BASE CONTENITORE SOLUBILE SINGOLO</i>

Model Machine

MACSAE160

CRISTALLO 400 EVO(10004761)

	28		11001580	PIN WHEEL CONTAINER SINGLE SOLUBLE <i>PERNO RUOTA DENTATA CONT.SOLUB.SINGOLO</i>
	29	 ПІД ЗАМОВЛЕННЯ	11031692	FELT RING DE=47,4 DI=41,4H=4 <i>FELT RING DE=47,4 DI=41,4H=4</i>
	30		9121.155	HOOD FOR RATIOMOTOR <i>CUFFIA X MOTORIDUTTORE</i>
	31		9121.106.00P	SUGAR RATIOMOTOR 24V DC <i>MOTORIDUTTORE ZUCCHERO 24V D.C.</i>
	32		9111.131	COUPLING FOR SOLUBLES MOTOR <i>GIUNTO X MOTORE SOLUBILI</i>
	33		U116.003	SCREW AUT.PT TCB 3,0X12 WN 1441 <i>VITE AUT.PT TCB 3,0X12 WN 1441 ZNP</i>
	34		11031679	DISPENSER FAN EASY DRY <i>DISPENSER FAN EASY DRY</i>
	35	 LIBERTY LUCASINE	11005182	WHEEL Z=9 <i>WHEEL Z=9</i>
	36	 ПІД ЗАМОВЛЕННЯ	11031678	EASY DRY DISPENSER APERTURE <i>EASY DRY DISPENSER APERTURE</i>
	37		11031691	CARTER FOR GEAR EASY DRY <i>CARTER FOR GEAR EASY DRY</i>
	38		11031690	WHEEL Z=18 EASY DRY <i>WHEEL Z=18 EASY DRY</i>
	39		11005168	LID CARTER GEAR <i>LID CARTER GEAR</i>
	40	 ПІД ЗАМОВЛЕННЯ	21001290	KIT NEW POWDER DISPENSING SYSTEM <i>KIT NEW POWDER DISPENSING SYSTEM</i>

Model Machine

MACSAE160

CRISTALLO 400 EVO(10004761)

MACSAE160.T.0007

TAVOLA NR. 7 - ARTICOLO CRISTALLO 400 EVO(10004761)

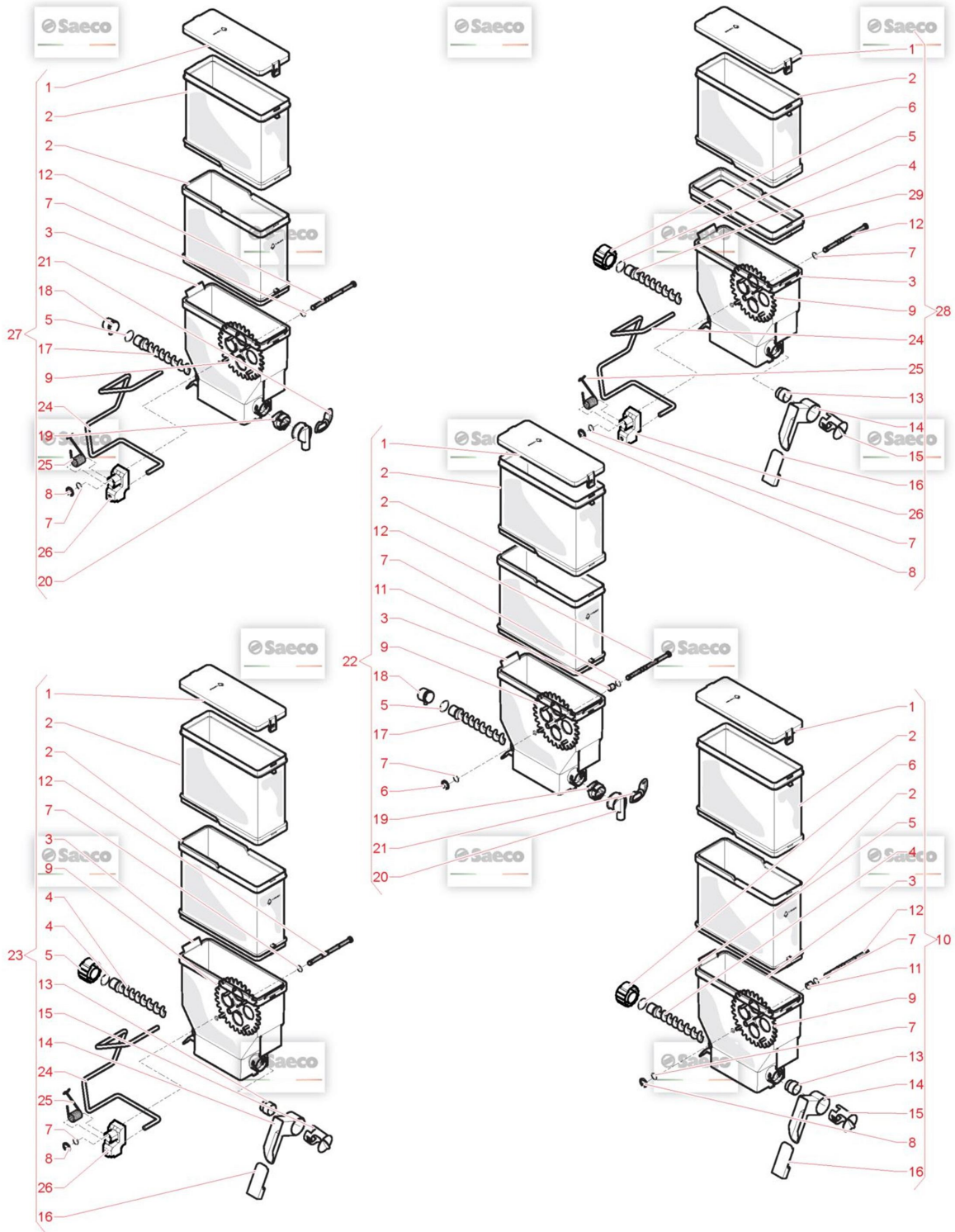

Model Machine

MACSAE160

CRISTALLO 400 EVO(10004761)

Web Pos. Foto Item - Replace by Description



Press - CTRL + CLICK go to item in a new window
Натисніть - Ctrl + права кнопка миші щоб відкрити запчастину в новому вікні



1



11001578

COVER CONTAINER SINGLE SOLUBLE
COPERCHIO CONTENITORE SOLUBILE SINGOLO



2



11001577

EXTENSION CONTAINER SINGLE SOLUBLE
PROLUNGA CONTENITORE SOLUBILE SINGOLO



3



11001576

BASE CONTAINER SINGLE SOLUBLE
BASE CONTENITORE SOLUBILE SINGOLO



4



11001658

SCROLL SCREW
COCLEA PER DEVIATORE



5



NM03.013

OR 2,3X15 NBR
OR 2,3X15 NBR



6



11012130

BACK BUSH REINFORCE
BACK BUSH REINFORCE



7



NM03.022

OR ORM 0060-10 NBR
OR ORM 0060-10 NBR



8



U701.003

SNAP RING 7 UNI 7434
ANELLO ELASTICO 7 UNI 7434



9



9111.702

WHEEL DOUBLE CONTAINER
RUOTA CONTENITORE DOPPIO



10



11004505

ASSEMBLY SINGLE CONTAINER W/SWITCH
ASS.MONTATO CONT.SINGOLO C/DEVIATORE



11



11032945

SPACE FOR GEAR BPA FREE
SPACE FOR GEAR BPA FREE



12



11001580

PIN WHEEL CONTAINER SINGLE SOLUBLE
PERNO RUOTA DENTATA CONT.SOLUB.SINGOLO



13































11001654

BUSH CONTAINER
BOCCOLA CONTENITORE

Model Machine

MACSAE160

CRISTALLO 400 EVO(10004761)

	14		9111.425.060	POWDER DUCT <i>CONDOTTO POLVERE ORIENTABILE</i>
	15		9111.457.060	BUSH FOR LEFT/RIGHT DUCT COSMEC <i>BOCCOLA X CONDOTTO DX-SX COSMEC</i>
	16		9111.428.060	PLUG FOR LEFT-RIGHT DUCT <i>TAPPO X CONDOTTO DX-SX</i>
	17		9111.701	SCROLL SCREW DOUBLE CONTAINER <i>COCLEA CONTENITORE DOPPIO</i>
	18		11005457	REAR BUSH NEW <i>BOCCOLA POSTERIORE UN SOLO AGGANCIAMENTO NEW</i>
	19		9111.630.060	BUSH FOR POWDERS TANK <i>BOCCOLA X SERBAT.POLVERI C/AGGANCI</i>
	20		9111.629.060	APERTURE FOR SOLUBLES HOPPER <i>APERTURE FOR SOLUBLES HOPPER</i>
	21		9111.338.270	BULKHEAD FOR APERT. CLOSURE ORANGE <i>PARATIA CHIUSURA BOCCHETTA ARANCIO</i>
	22		11026696	ASSEMBLY SINGLE CONTAINER <i>ASS.MONT.CONTENITORE SINGOLO</i>
	23		11006373	ASS.SINGLE CONTAINER W/AGITATOR SWITCH <i>ASS.SINGLE CONTAINER W/AGITATOR SWITCH</i>
	24		11006124	WIRE AGITATOR UNIFIED <i>FILO AGITATORE UNIFICATO WIRE AGITATOR UNIFIED</i>
	25		9111.731	SPRING <i>MOLLA AGITATORE</i>
	26		11007155	ПЛАСТИКОВИЙ ТРИМАЧ ВЗБИВАЛКИ SAECO 9111.735 <i>AGITATOR SUPPORT</i>
	27		11006123	ASSEMBLY SINGLE CONTAINER WITHAGITATOR <i>ASS.MONT.CONTENITORE SINGOLO C/AGITATORE</i>

Model Machine

MACSAE160

CRISTALLO 400 EVO(10004761)



28

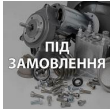

11032718

ASSEMBLY SINGLE CONTAINER H.350
ASSEMBLY SINGLE CONTAINER H.350



29

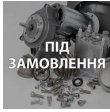

11032119

ADAPTER FOR EXTENSION CONTAINER SOLUBLE
ADAPTER FOR EXTENSION CONTAINER SOLUBLE

Model Machine

MACSAE160

CRISTALLO 400 EVO(10004761)

MACSAE160.T.0008

TAVOLA NR. 8 - ARTICOLO CRISTALLO 400 EVO(10004761)

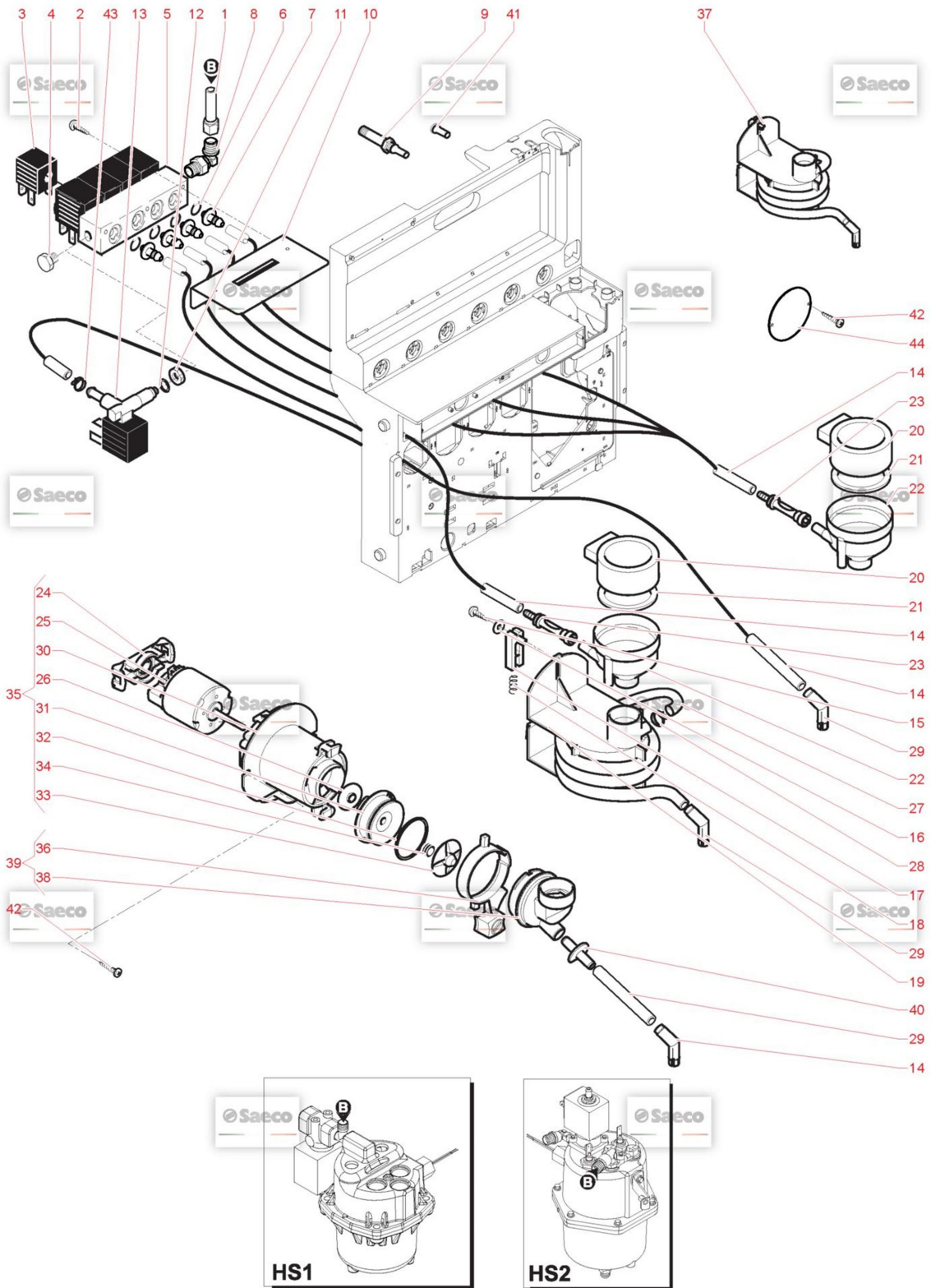

Model Machine

MACSAE160

CRISTALLO 400 EVO(10004761)

Web Pos. Foto Item - Replace by Description



Press - CTRL + CLICK go to item in a new window
Натисніть - Ctrl + права кнопка миші щоб відкрити запчастину в новому вікні



1



11025295

TEFLON TUBE 3X6 L.170 1/8"-1/8
TEFLON TUBE 3X6 L.170 1/8-1/8



2



U109.021

SCREW AUT.TCB 3,5X22 DIN 7981C
SCREW AUT.TCB 3,5X22 DIN 7981 C



3



20005373

SOLENOID X HS1 11023762
SOLENOID X OLAB 24V DC 6000BH/BODN



4

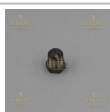

12001169

ЛАТУННА ЗАГЛУШКА BRASS CAP 1/8 GAS CONICAL TEA
BRASS CAP 1/8 GAS CONICAL TEA



5



11011470

BLOCK 4 ELECTROVALVE DC OLAB TEA
BLOCK 4 ELECTROVALVE DC OLAB TEA



6



NM01.004

OR 2025 SILICONE
OR 2025 SILICONE



7



11011453

RUBBER HOLDER CONNECTOR TEA
RUBBER HOLDER CONNECTOR TEA



8



11025082

1/8"G M/CONICAL ORIENT. NUT/OGV
1/8G M/CONICAL ORIENT. NUT/OGV



9



20005374

ASS.NUCLEO FIS+MOB.X 11009225
ASS.NUCLEUS 6000BH/BODN X 11009225



10

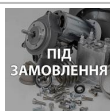

9111.713

PLATE
PIASTRA ELETTRORVALVOLE



11



9991.035

NUT 1/8 H 4.5
DADO 1/8 H.4,5



12



140321462

O-RING 2018 SILICONE
OR 2018 IN SILICONE



13































11027286

ELETTRORVALVE 24V DC TEA
ELETTRORVALVE 24V DC TEA

Model Machine

MACSAE160



























CRISTALLO 400 EVO(10004761)

	14		9972.057	КОРИЧНЕВА ГУМОВА ТРУБКА 5X8 2 МЕТРИ <i>TUBO SILICONE MARRON 5X8 L.2000 MM</i>
	15		U116.005	SCREW AUT.PT TCB 3,0X8 WN 1441 <i>VITE AUT.PT TCB 3,0X8 WN 1441 ZNP</i>
	16		U207.004	PLAIN WASHER 4,3X16 UNI 6592 GAL <i>PLAIN WASHER 4,3X16 UNI 6592 GAL</i>
	17		9111.209.060	CURSOR FOR SPIRAL MIXER FIXING <i>CURSOR FOR SPIRAL MIXER FIXING</i>
	18		9111.211	SPRING FOR MIXER CURSOR <i>MOLLA X CURSORE MISCELATORE</i>
	19		9111.643.060	RAPID FIXING MIXER <i>RAPID FIXING MIXER</i>
	20		9111.010.060	LID FOR FUNNEL BROWN <i>COPERCHIO X IMBUTO MARRON</i>
	21		9111.011.060	SEAL FOR FUNNEL BROWN <i>GUARNIZIONE X IMBUTO MARRON</i>
	22		9111.009.060	FUNNEL FOR POWDERS BROWN <i>IMBUTO X POLVERI MARRON</i>
	23		1863.A07	ESPRESSO NOZZLE <i>ASS.UGELLO ESPRESSO</i>
	24		9111.771.270	MOTOR COUPLING ORANGE RAL <i>MOTOR COUPLING ORANGE RAL</i>
	25		9121.248.00P	MOTOP MIKCEPA '05 24V DC - M.B.T. COD. 912124800 SAECO 9121.248.00 <i>MOTORE MIXER '05 24V DC - M.B.T.</i>
	26		9111.773.060	MOTOR PROTECTION RING <i>ANELLO PROTEZIONE MOTORE MIXER '05</i>
	27		9972.055	ТРУБКА СИЛІКОНОВА 8X12 2 МЕТРИ <i>SILICONE TUBE 8X12 L.2000MM</i>

Model Machine

MACSAE160











CRISTALLO 400 EVO(10004761)

	28		NV99.072	HOSE CLAMP D. 11.6/12.3 HOSE CLAMP D. 11.6/12.3
	29		9111.349	ELBOW DISPENSING NOZZLE UGELLO EROGAZIONE GOMITO
	30		9111.769.150	MIXER FLANGE MIXER FLANGE
	31		9111.770.060	COVER MIXER FLANGE COVER MIXER FLANGE
	32		NM03.012	OR ORM 0320-25 NBR OR ORM 0320-25 NBR
	33		9111.772.060	DISK FAN VENTOLINA A DISCO MIXER '05
	34		NM05.015	ПРОКЛАДКА V-RING 405 МІКСЕРА ДЛЯ КАВОМАШИН SAECO V-RING MIXER '05
	35		9110.160.06P	ДВИГУН МІКСЕРА ДЛЯ КАВОМАШИНИ SAECO 05 24V DC SAECO 9110.1... ASS.MIXER '05 24V DC GROUP 500 SAECO
	36		9111.230.270	MIXER LOCKING RING NUT ORANGERAL GHIERA BLOCCAGGIO MIXER ARANCIO RAL
	37		1863.A10	ASS.MIXER FS400 ASS.MIXER A SPIRALE FS400
	38		9111.227.060	MIXER CASING CORPO MIXER
	39		9110.027.060	MIX CASING ASS. ASS.CORPO MIX SAECO CRISTALLO,ATLANTE,QUARZO,RUBINO
	40		9111.232.060	STD TUBE HOLDER SLEEVE MANICOTTO PORTATUBO STANDARD

Model Machine

MACSAE160

CRISTALLO 400 EVO(10004761)

	40		9111.233.060	DECAFF.TUBE HOLDER SLEEVE <i>MANICOTTO PORTATUBO DECAFFEINATO</i>
	41		20007305	ЧАСТИНА ЕЛЕКТРОМАГНІТНОГО КЛАПАНА З ПОДВИЖНИМ СЕРДЕЧНИК... <i>SPARE EV MOBILE CORE 11023762</i>
	42		U116.006	SCREW AUT.PT TCB 3,5X12 WN 1441 ZNP <i>VITE AUT.PT TCB 3,5X12 WN 1441 ZNP</i>
	43		NV99.036	HOSECLAMP D=8,5 09993.41.00 <i>HOSECLAMP D=8,5 09993.41.00</i>
	44		9111.405.060	MIXER HOLE CAP BROWN <i>MIXER HOLE CAP BROWN</i>

Model Machine

MACSAE160

CRISTALLO 400 EVO(10004761)

MACSAE160.T.0009



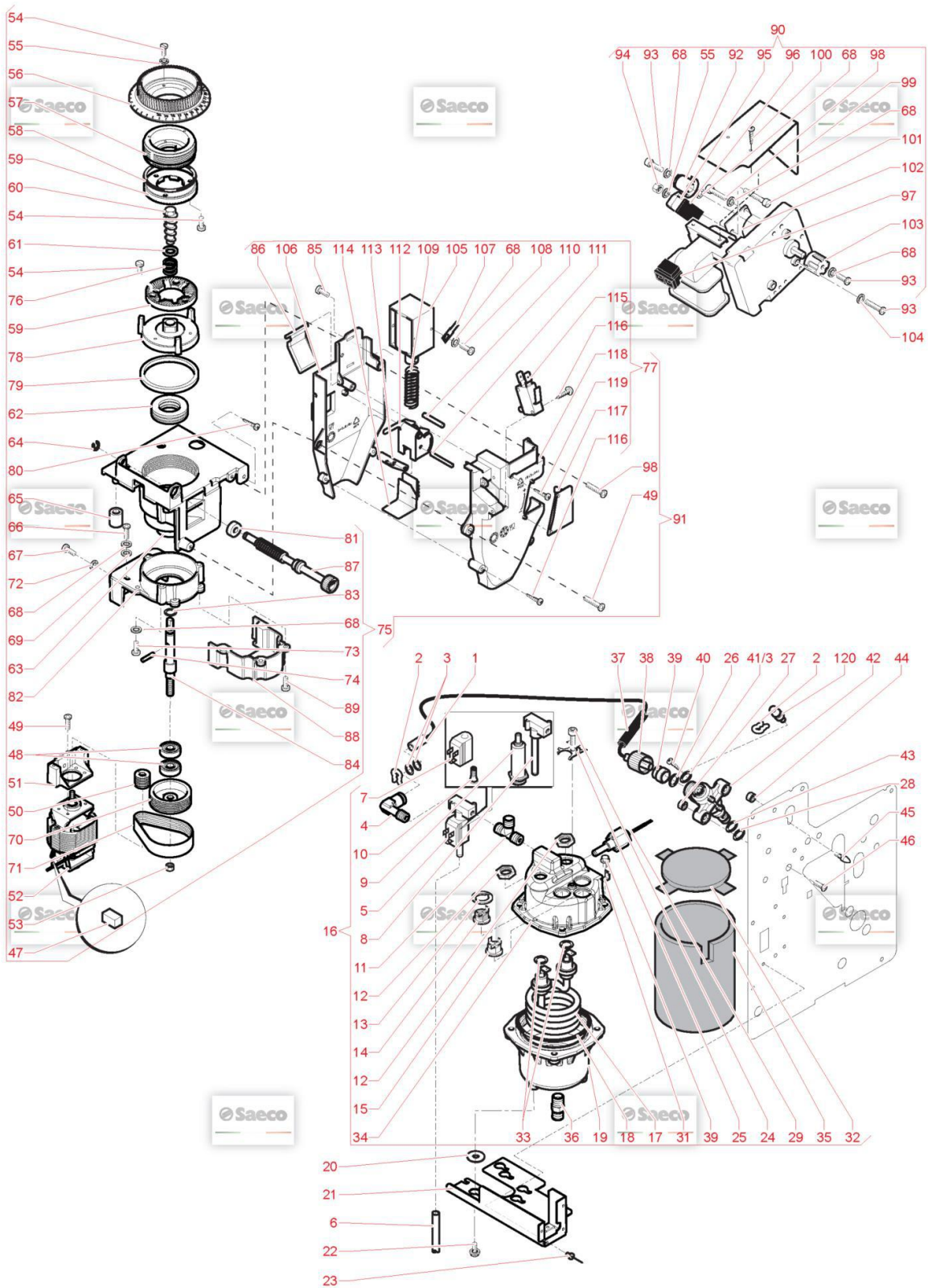









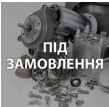













TAVOLA NR. 9 - ARTICOLO CRISTALLO 400 EVO(10004761)



Model Machine

MACSAE160





























CRISTALLO 400 EVO(10004761)

Web	Pos.	Foto	Item - Replace by	Description
				<i>Press - CTRL + CLICK go to item in a new window Натисніть - Ctrl + права кнопка миші щоб відкрити запчастину в новому вікні</i>
	1		11032592	TUBE TEFLON 4X2 L.320 <i>TUBE TEFLON 4X2 L.320</i>
	2		9011.144	SS FORK FOR TUBE D=4 <i>FORCELLA X TUBO D.4</i>
	3		140328059	OR 2015 SILICONE PTFE/FDA <i>OR 2015 SILICONE PTFE/FDA</i>
	4		9181.348	TEA/BRASS CONNECTOR 1/8" CONICAL AT 90° <i>TEA/BRASS CONNECTOR 1/8 CONICAL AT 90°</i>
	5		11032408	ЕЛЕКТРОМАГНІТНИЙ КЛАПАН 3 WAYS 24V <i>ELECTROVALVE ODE 3 WAYS 24V DC</i>
	6		9972.057	КОРИЧНЕВА ГУМОВА ТРУБКА 5X8 2 МЕТРИ <i>TUBO SILICONE MARRON 5X8 L.2000 MM</i>
	7		20007361	SOLENOID EVT ODE <i>SOLENOID EVT ODE</i>
	8		20007364	SPARE EVT 11032408 <i>SPARE EVT 11032408</i>
	9		20007363	SPARE EVT ODE <i>SPARE EVT ODE</i>
	10		20007362	SPARE CORE EV ODE <i>RIC. NUCLEO EVT ODE</i>
	11		11011454	"T" CONNECTOR FOR BOILER TEAT"" CONNECTOR FOR BOILER TEA <i>RACCORDO A T X CALDAIA TEA</i>
	12		9991.029	NUT FOR RESISTOR <i>DADO X RESISTENZA</i>
	13		9991.085	THERMOSTAT FIXING WASHER <i>RONDELLA FERMATERMOSTATI</i>

Model Machine

MACSAE160























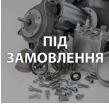

CRISTALLO 400 EVO(10004761)

	14		NE09.021	THERMOSTAT 150°NC FASTON 90° <i>TERMOSTATO 150°NC FASTON 90°</i>
	15		189428700	THERMOSTAT 175° 1NT-15L-5126 <i>THERMOSTAT 175° 1NT-15L-5126</i>
	16		11033527	BOILER 300CC EVO 1EV+SOLUBLES230 1,4KW <i>BOILER 300CC EVO 1EV+SOLUBLES 230 1,4KW</i>
	17		11007591	RES CALD. V230 W1400 INC.800 <i>RESISTENZA 230V 1400W INC.800</i>
	18		NM04.010	OR ORM 0730-40 FPM 70+-5 IRHDBLACK <i>OR ORM 0730-40 FPM 70 +-5 IRHD NERO</i>
	19		11033133	LOWER CASING BOILER 300CC TEA <i>CORPO INFERIORE CALDAIA 300CC TEA</i>
	20		9111.501	INSULATION WASHER <i>INSULATION WASHER</i>
	21		11033252	PLATE BOILER <i>SUPPORTO CALDAIA UNIFICATO</i>
	22		U046.005	SCREW TE M5,0X10 WITH WASHER <i>SCREW TE M5,0X10 WITH WASHER</i>
	23		NF11.115	BLIND RIVETS <i>BLIND RIVETS</i>
	24		12001052	SCREW TCEI M4,0X6 DIN 912 ZIN <i>SCREW TCEI M4,0X6 DIN 912 ZIN</i>
	25		226830200	RETAIN.SPRING 3 THERM. +THERMAL FUSE <i>RETAIN.SPRING 3 THERM. +THERMAL FUSE</i>
	26		12001810	OR 275 DE.8,04 SILICONE PERNOMANICOTTO <i>OR 275 DE.8,04 SILICONE PERNO MANICOTTO</i>
	27		U302.003	МЕТАЛЕВА ГАЙКА M4 UNI 5588 ZNP <i>DADO ESAGONALE M4 UNI 5588 ZNP</i>

Model Machine

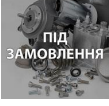
MACSAE160

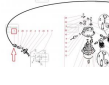



























CRISTALLO 400 EVO(10004761)

	28		11013174	OR ORM 0050-20 FKM 80 FD GREENPEROXIDA OR ORM 0050-20 FKM 80 FD GREEN PEROXIDA
	28		NM01.057	OR ORM 0050-20 IN SILICONE OR ORM 0050-20 IN SILICONE
	29		11033134	ПОГРУЖНИЙ ЗОНД ТЕМПЕРАТУРИ SAECO ASS. SONDA TEMPERATURA AD IMMERSIONE
	30		U023.020	SCREW TCEI M6X20 UNI 5931 ZIN VITE TCEI M6X20 UNI 5931 8.8
	31		NE15.031	MALE TONGUE PLAIN 6,3 D.6,3 MALE TONGUE PLAIN 6,3 D.6,3
	32		11030777	COFFEE BOILER 600CC UPPER ISOLATOR COFFEE BOILER 600CC UPPER ISOLATOR
	33		11000972	OR 3050 FKM 80 FD PEROXIDICA OR 3050 FKM 80 FD PEROXIDICA
	34		11033131	UPPER CASING BOILER 300CC TEA CORPO SURIORE CALDAIA 300CC TEA NUOVO PREZZO 32.64
	35		11030779	ІЗОЛЯЦІЯ НИЖНЬОЇ ЧАСТИНИ БОЙЛЕРА 600CC COFFEE BOILER 600CC UPPER ISOLATOR
	36		9991.059	STRAIGHT BICONE CONNECTOR M 1/8X06 STRAIGHT BICONE CONNECTOR M 1/8X06
	37		9972.236	BLACK SILICONE TUBE 7,5X9,3 L=200 MM BLACK SILICONE TUBE 7,5X9,3 L=200 MM
	38		11029574	ГАЙКА ДЛЯ РУЧНОГО ЗАЖИМУ M14 ДЛЯ ТРУБКИ 4X2 GODRONE FEMMINA M14 X TUBO 4X2
	39		11005741	CONNECTOR D.6 BOCCOLA ESTERNA D.6

Model Machine

MACSAE160











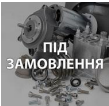

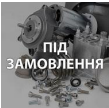













CRISTALLO 400 EVO(10004761)

	40		U109.037	SCREW AUT.TCB 4,8X13 DIN 7981C VITE AUT.TCB 4,8X13 DIN 7981 C NIK
	41		140321462	O-RING 2018 SILICONE OR 2018 IN SILICONE
	42		11005370	PIN FOR MUFF PERNO X MANICOTTO PIN FOR MUFF
	42	 ПІД ЗАМОВЛЕННЯ	11032673	PIN FOR MUFF PERNO X MANICOTTO CAPS
	43	 ПІД ЗАМОВЛЕННЯ	11013173	OR ORM 0090-20 FKM 80 FD GREENPEROXIDA OR ORM 0090-20 FKM 80 FD GREEN PEROXIDA
	43		NM01.035	OR ORM 0090-20 SILICONE OR ORM 0090-20 SILICONE
	44		U302.001	NUT HEXAGONAL M5 UNI 5588 DADO ESAGONALE M5 UNI 5
	45	 ПІД ЗАМОВЛЕННЯ	11006046	PEG FOR BOILER PEG FOR BOILER
	46		U044.013	SCREW TSPC M4,0X12 UNI 7688 GALV. VITE TSPC M4,0X12 UNI 7688 ZNP
	47	 ПІД ЗАМОВЛЕННЯ	20007420	MOTOR BRUSH MOTOR BRUSH
	48		11025696	BEARING RTP 608-2Z BEARING RTP 608-2Z
	49		12002039	SCREW TCBD TORX 20 M4X12 ZN-B VITE TCBD TORX 20 M4X12 ZN-B
	50		11025690	PULLEY D.15 "GRIND 48" PULLEY D.15 "GRIND 48"
	51	 ПІД ЗАМОВЛЕННЯ	11027163	MOTOR SUPPORT GRINDERS D.48 MOTOR SUPPORT GRINDERS D.48

Model Machine

MACSAE160























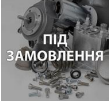

CRISTALLO 400 EVO(10004761)

	52	 ПІД ЗАМОВЛЕННЯ	11027396	COFFEEGRINDER MOTOR D.48 230V COFFEEGRINDER MOTOR D.48 230V
	52	 ПІД ЗАМОВЛЕННЯ	11027810	COFFEEGRINDER MOTOR D.48 120V MOTORE MACINACAFFE' D.48 120V
	53		U310.004	NUT SELF LOCK.M6 UNI 7473 NUT SELF LOCK.M6 UNI 7473
	54		U043.007	SCREW TCBC M3,0X8 UNI 7687 GALV. SCREW TCBC M3,0X8 UNI 7687 GALV.
	55		U208.002	TOOTHED WASHER 3,3X5,8 UNI 3703 G ROSETTA DENT. 3,3X5,8 UNI 3703 ZNP
	56		1813.103.A20	RING NUT OF GRIND REGULATION RING NUT OF GRIND REGULATION
	57		11025692	UPPER GRINDING DISK HOLDER "GRIND 48" UPPER GRINDING DISK HOLDER "GRIND 48"
	58		12001617	OR 3206 NBR OR 3206 NBR
	59		11021838	НІЖ КАВОМОЛКИ SAECO D-48 (1ШТ.) FLAT MILL D.47 TEA
	60		11025695	ШНЕК БОЛТИК ЗБІЛЬШЕННЯ "MACINE 48" INCREASE SCREW "GRIND 48"
	61		11027418	SPACER FOR SCREW OF INCREASE SPACER FOR SCREW OF INCREASE
	62		11025699	BEARING RTP 51104 BEARING RTP 51104
	63		11027162	GRINDERS CAP D.48 GRINDERS CAP D.48
	64		U701.011	STEEL SNAP RING 5 UNI 7434 ANELLO ELASTICO 5 UNI 7434

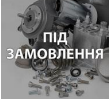
Model Machine

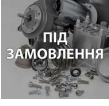
MACSAE160











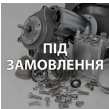

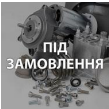

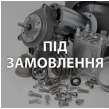









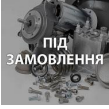

CRISTALLO 400 EVO(10004761)

	65		1813.046.050	RUBBER GRIND SUPPORT <i>RUBBER GRIND SUPPORT</i>
	66		12002052	ZN-B TCB SCREW M4X16 <i>ZN-B TCB SCREW M4X16</i>
	67		U023.004	SCREW TCEI M6,0X12 UNI 5931 GALV. <i>VITE TCEI M6,0X12 UNI 5931 Z</i>
	68		128310404	МЕТАЛЕВЕ УБЧАСТЕ КОЛІЩАТКО UNI 8842 A4 <i>WASHER UNI 8842 A4 BURNISHED</i>
	69		U207.004	PLAIN WASHER 4,3X16 UNI 6592 GAL <i>PLAIN WASHER 4,3X16 UNI 6592 GAL</i>
	70	 ПІД ЗАМОВЛЕННЯ	11025689	PULLEY D.40 "GRIND 48" <i>PULLEY D.40 "GRIND 48"</i>
	71		11032130	BELT GRINDER COFFEE <i>BELT GRINDER COFFEE</i>
	72		U208.006	TOOTHED WASHER 6,4X11 UNI 3703 <i>ROSETTA DENT. 6,4X11 UNI 3</i>
	73	 ПІД ЗАМОВЛЕННЯ	12001700	SCREW TCB M4X30 UNI 7687 ZNP <i>SCREW TCB M4X30 UNI 7687 ZNP</i>
	74	 ПІД ЗАМОВЛЕННЯ	11025921	POWER PLUG UNI-EN 28743 D.3X14 <i>POWER PLUG UNI-EN 28743 D.3X14</i>
	75	 ПІД ЗАМОВЛЕННЯ	11027165	КАВОМОЛКА В ЗБОРІ Д 48 SAECO 11027165 <i>COFFEE GRINDER D.48</i>
	75	 ПІД ЗАМОВЛЕННЯ	11034068	COFFEE GRINDER D.48 120V 60HZ <i>COFFEE GRINDER D.48 120V 60HZ</i>
	76		11025694	SPRING "GRIND 48" <i>SPRING GRIND 48</i>

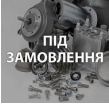
Model Machine

MACSAE160











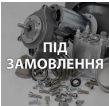















CRISTALLO 400 EVO(10004761)

	77		11033675	DOSER <i>DOSER</i>
	77		11033677	DOSER <i>DOSER</i>
	77		1813.A10.A2N	DOSER ASS. 6-11 GR. 220V 60HZ <i>DOSER ASS. 6-11 GR. 220V 60HZ</i>
	78		11025691	ТРИМАЧ НИЖНЬОГО НОЖА Д.48 <i>LOWER GRINDING DISK HOLDER GRIND 48</i>
	79		11027451	ПРОКЛАДКА DE=47,4 DI=41,4H=4 IN F <i>ПРОКЛАДКА DE=47,4 DI=41,4H=4 IN F</i>
	80		U116.006	SCREW AUT.PT TCB 3,5X12 WN 1441 ZNP <i>VITE AUT.PT TCB 3,5X12 WN 1441 ZNP</i>
	81		1813.159	ANTIVIBRATION RUBBER <i>ANTIVIBRATION RUBBER</i>
	82		11027164	MOTOR SUPPORT GRINDERS D.48 <i>MOTOR SUPPORT GRINDERS D.48</i>
	83		140321662	O-RING 2021 SILICONE <i>OR 2021 IN SILICONE</i>
	84		11025693	CENTRAL PIN "GRIND 48" <i>CENTRAL PIN "GRIND 48"</i>
	85		12002151	TSP SCREW M3X4 UNI 7688 SS <i>TSP SCREW M3X4 UNI 7688 SS</i>
	86		1813.042.A20	DISPENSER PALLET <i>DISPENSER PALLET</i>
	87		1813.104.A20	ADJUSTMENT SCREW WITH TUBE HOLDER <i>VITE REGOLAZIONE MACININO</i>
	88		11027186	ЧАСТИНА КРИПЛЕННЯ КАВОМОЛКИ SAECO <i>SHELL CLOSURE BELT</i>

Model Machine

MACSAE160

















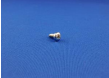





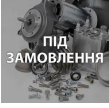

CRISTALLO 400 EVO(10004761)

	89		U127.010	SCREW TAPT.TCB M4,0X10 DIN 7500C <i>SCREW TAPT.TCB M4,0X10 DIN 7500C</i>
	90		11025216	ASS.RATIOMOTOR FOR DA 230V FS400 <i>ASS.RATIOMOTOR FOR DA 230V FS400</i>
	90		11025217	ASS.RATIOMOTOR FOR DA 220/60 FS400 <i>ASS.RATIOMOTOR FOR DA 220/60 FS400</i>
	90		11025218	ASS.RATIOMOTOR FOR DA 120V FS400 <i>ASS.RATIOMOTOR FOR DA 120V FS400</i>
	91		11032631	COFFEE GRINDER D.48+DISPENCER220V/60HZ <i>COFFEE GRINDER D.48+DISPENCER 220V/60HZ</i>
	91		11033678	COFFEE GRINDER D.48 + DISPENCER <i>COFFEE GRINDER D.48 + DISPENCER</i>
	91		11034069	COFFEE GRINDER D.48 + DISPENCER 120V CRS <i>COFFEE GRINDER D.48 + DISPENCER 120V CRS</i>
	92		9991.037	CAM FOR RATIOMOTOR 1 MICRO <i>CAMMA X MOTORIDUTTORE 1 MICRO</i>
	93		129824002	TCB SCREW M4X10 UNI 7687 ZNP <i>VITE TCB M4X10 UNI 7687 ZNP</i>
	94		U302.002	NUT HEXAGONAL M3 UNI 5588 <i>NUT HEXAGONAL M3 UNI 5588</i>
	95		NE05.066	MICROSWITCH CHERRY D419Q1A <i>МІКРОПЕРЕМИКАЧ РЕДУКТОРА РОБОЧОЇ ГРУПИ</i>
	96		9991.014	CARD FOR MICRO SWITCHES <i>CARTONCINO X MICROINTERRUTTORE</i>
	97		11032817	RATIOMOTOR 30 PACK 230/240-50 <i>RATIOMOTOR 30 PACK 230/240-50</i>
	97		11032818	RATIOMOTOR 30 PACK 120/60 <i>RATIOMOTOR 30 PACK 120/60</i>

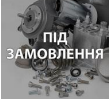
Model Machine

MACSAE160























CRISTALLO 400 EVO(10004761)

	97		11032819	RATIOMOTOR 30 PACK 220/60 <i>MOTORIDUTT.IN PLASTICA PACCO 30 220/60</i>
	98		129825502	TCB SCREW M4X25 UNI 7687 ZNP <i>TCB SCREW M4X25 UNI 7687 ZNP</i>
	99		11014251	CENTRAL UNIT MOTOR STEEL CARTER <i>CENTRAL UNIT MOTOR STEEL CARTER</i>
	10001		129511903	SCREW TCB 2,9X6,4 DIN 7981 BZNICK <i>SCREW TCB 2,9X6,4 DIN 7981 BZ NICK</i>
	1010		U034.003	SCREW TCI M3,0X20 UNI 6107 GALV. <i>SCREW TCI M3,0X20 UNI 6107 GALV.</i>
	1020		9991.015	PLATE FOR MICRO <i>PIASTRINA X MICRO</i>
	1030		9991.013	JOINT FOR RATIOMOTOR <i>GIUNTO X MOTORIDUTTORE</i>
	1040		U207.002	PLAIN WASHER 4,3X9 UNI 6592 GAL <i>ROSETTA PIANA 4,3X9 UNI 6592 ZNP</i>
	1050		9121.235.00A	ELECTROMAGNET FOR DISPENSER WITH NUCLEUS <i>ELETTROM. PER DOSATORE CON NUCLEO</i>
	1060		11033683	DISPENSER SHELL <i>DISPENSER SHELL</i>
	1070		NE15.003	MALE TONGUE PLAIN 6,3 D.5,2 <i>LINGUETTA MASCHIO PIANA 6,3 D.5,2</i>
	1080		129821402	TCB SCREW M3X4 UNI 7687 ZNP <i>TCB SCREW M3X4 UNI 7687 ZNP</i>
	1090		1813.127	SPRING FOR ELECTROMAGNET <i>MOLLA X ELETTROMAGNETE DOSAT</i>

Model Machine

MACSAE160

CRISTALLO 400 EVO(10004761)

	1100		1813.092	PIN <i>PIN</i>
	1110		1813.091	PIN FOR DISPENSER REGULATION <i>PIN FOR DISPENSER REGULATION</i>
	1120		1813.043.A20	DISPENSER REGULATION <i>REGOLATORE DOSATORE</i>
	1130		1813.078.A20	ADJUSTMENT LEVER <i>ADJUSTMENT LEVER</i>
	1140		1813.044.A20	PALLET FOR REGULATION <i>PALETTA X REGOLATORE</i>
	1150		NE05.062	MICROSWITCH + WHEEL <i>MICROINTERRUTTORE C/ROTELLA</i>
	1160		U116.004	SCREW AUT.PT TCB 3,0X16 WN 1441 <i>SCREW AUT.PT TCB 3,0X16 WN 1441</i>
	1170		1813.191.A20	DISPENSER COVER <i>COPERTURA DOSATORE</i>
	1180		11033684	OUTSIDE SHELL DISPENSER <i>GUSCIO EST.DOSATORE 1813.041.A20 LAV.</i>
	1190		12000390	SCREW AUT.TCB 2,9X25 DIN 7981C NIK <i>SCREW AUT.TCB 2,9X25 DIN 7981 C NIK</i>
	1200		11033089	CAP SLEEVE CAPS <i>TAPPO MANICOTTO CAPS</i>

Model Machine

MACSAE160

CRISTALLO 400 EVO(10004761)

MACSAE160.T.0010

TAVOLA NR. 10 - ARTICOLO CRISTALLO 400 EVO(10004761)

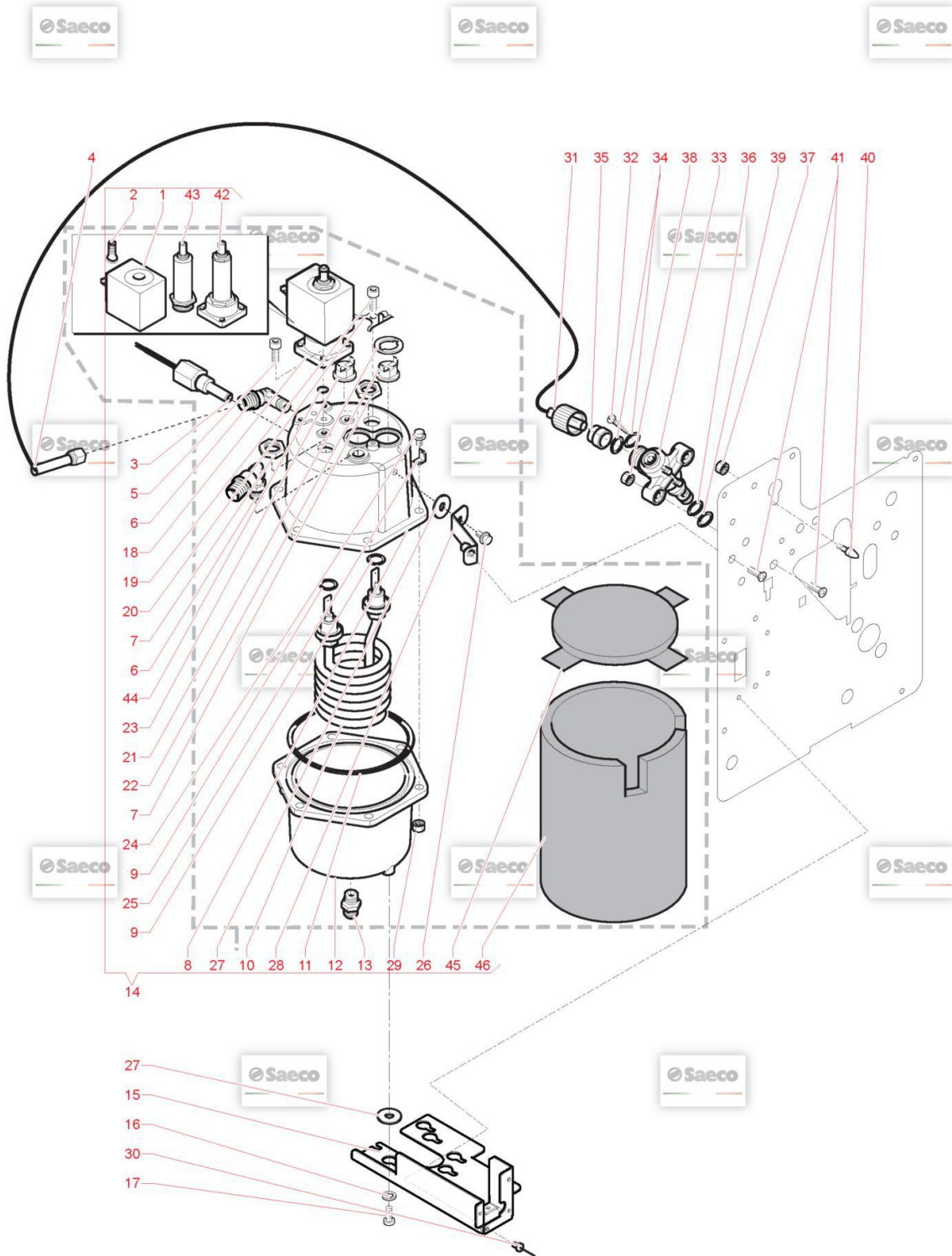

Model Machine

MACSAE160

CRISTALLO 400 EVO(10004761)

Web Pos. Foto Item - Replace by Description



Press - CTRL + CLICK go to item in a new window

Натисніть - Ctrl + права кнопка миші щоб відкрити запчастину в новому вікні



1



20007361

SOLENOID EVT ODE
SOLENOID EVT ODE



2



20007362

SPARE CORE EV ODE
RIC. NUCLEO EVT ODE



3



11005368

IMMERSION PROBE ASS.
ASS.SONDA TEMPER.AD.IMMERSIONE



4

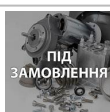

11025409

TUBE ASSEMBLY TEFLON 3X6 L.220MM
TUBE ASSEMBLY TEFLON 3X6 L.220MM



5

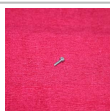

12001179

SCREW TCEI M4,0X12 UNI 5931 8.8 ZIN.
SCREW TCEI M4,0X12 UNI 5931 8.8 ZIN.



6

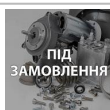

12001181

BICONICAL CONNECT. L M 1/8X06TEA
BICONICAL CONNECT. L M 1/8X06 TEA



7



9991.029

NUT FOR RESISTOR
DADO X RESISTENZA



8



11012528

UPPER CASING BOILER 600CC TEA
UPPER CASING BOILER 600CC TEA



9

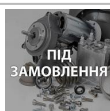

11000972

OR 3050 FKM 80 FD PEROXIDICA
OR 3050 FKM 80 FD PEROXIDICA



10



11005367

ЕЛЕКТРОВОДОНАГРІВАЧ 230V 1550W
HEAT ELEMENT BOILER 230V 1550W



10

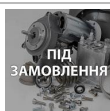

11005374

HEAT ELEMENT BOILER 120V 1100W
HEAT ELEMENT BOILER 120V 1100W



11



12000770

OR ORM 4350 VITON
OR METRICO 4350 IN VITON



12























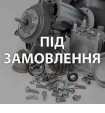





11012529

LOWER CASING BOILER 600CC TEA
LOWER CASING BOILER 600CC TEA

Model Machine

MACSAE160















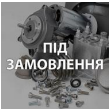



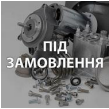





CRISTALLO 400 EVO(10004761)

	13		11027089	WATER INLET CONNECTOR WATER INLET CONNECTOR
	14		11025320	BOILER ASS. CRISTALLO600 600CC120/60 TEA BOILER ASS. CRISTALLO600 600CC120/60 TEA
	14		11025321	BOILER 600CC 230/50 TEA BOILER ASS. CRISTALLO600 600CC 230/50 TEA
	15		11033252	PLATE BOILER SUPPORTO CALDAIA UNIFICATO
	16		U207.001	PLAIN WASHER 5,3X10 UNI 6592 GAL ROSETTA PIANA 5,3X10 UNI 6
	17		U005.011	SCREW TE M4,0X10 UNI 5739 GALV. SCREW TE M4,0X10 UNI 5739 GALV.
	18		11012534	TEA ELECTROVALVE 2/3 WAY N.C. TEA ELECTROVALVE 2/3 WAY N.C.
	19		12001052	SCREW TCEI M4,0X6 DIN 912 ZIN SCREW TCEI M4,0X6 DIN 912 ZIN
	20		226760100	RETAINING SPRING 3 THERMOSTATS RETAINING SPRING 3 THERMOSTATS
	21		9991.085	THERMOSTAT FIXING WASHER RONDELLA FERMATERMOSTATI
	22		NE09.021	THERMOSTAT 150°NC FASTON 90° THERMOSTATO 150°NC FASTON 90°
	23		189428700	THERMOSTAT 175° 1NT-15L-5126 THERMOSTAT 175° 1NT-15L-5126
	24		U023.020	SCREW TCEI M6X20 UNI 5931 ZIN VITE TCEI M6X20 UNI 5931 8.8
	25		NE15.031	MALE TONGUE PLAIN 6,3 D.6,3 MALE TONGUE PLAIN 6,3 D.6,3

Model Machine

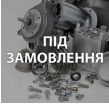
MACSAE160

CRISTALLO 400 EVO(10004761)

	26		U046.005	SCREW TE M5,0X10 WITH WASHER <i>SCREW TE M5,0X10 WITH WASHER</i>
	27		9111.501	INSULATION WASHER <i>INSULATION WASHER</i>
	28		11008063	BOILER 600CC SUPPORT CRISTALLO600 <i>SUPPORTO CALDAIA 600CC CRISTALLO600</i>
	29		U302.004	NUT HEXAGONAL M6 UNI 5588 <i>DADO ESAGONALE M6 UNI 5</i>
	30		NF11.115	BLIND RIVETS <i>BLIND RIVETS</i>
	31		11005743	KNURLED FEMALE HAND BOLT M14 <i>GODRONE FEMMINA M14</i>
	32		U109.037	SCREW AUT.TCB 4,8X13 DIN 7981C <i>VITE AUT.TCB 4,8X13 DIN 7981 C NIK</i>
	33		11005370	PIN FOR MUFF <i>PERNO X MANICOTTO PIN FOR MUFF</i>
	34		140321462	O-RING 2018 SILICONE <i>OR 2018 IN SILICONE</i>
	35		11005741	CONNECTOR D.6 <i>BOCCOLA ESTERNA D.6</i>
	36		11013173	OR ORM 0090-20 FKM 80 FD GREENPEROXIDA <i>OR ORM 0090-20 FKM 80 FD GREEN PEROXIDA</i>
	37		U302.001	NUT HEXAGONAL M5 UNI 5588 <i>DADO ESAGONALE M5 UNI 5</i>
	38		U302.003	МЕТАЛЕВА ГАЙКА M4 UNI 5588 ZNP <i>DADO ESAGONALE M4 UNI 5588 ZNP</i>

Model Machine

MACSAE160

CRISTALLO 400 EVO(10004761)



39

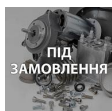

11013174

OR ORM 0050-20 FKM 80 FD GREENPEROXIDA
OR ORM 0050-20 FKM 80 FD GREEN PEROXIDA



40

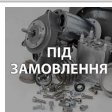

11006046

PEG FOR BOILER
PEG FOR BOILER



41



U044.013

SCREW TSPC M4,0X12 UNI 7688 GALV.
VITE TSPC M4,0X12 UNI 7688 ZNP



42

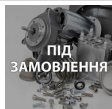

20007370

SPARE EVT 11012534
SPARE EVT 11012534



43

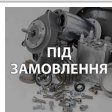

20007363

SPARE EVT ODE
SPARE EVT ODE



44



20007312

SPARE OR EVT HS2 11012534
SPARE OR EVT HS2 11012534



45



11030776

COFFEE BOILER 600CC UPPER ISOLATOR
ISOLANTE SUP.CALDAIA 600CC VENDING



46



11030778

COFFEE BOILER 600CC UPPER ISOLATOR
ISOLANTE PERIMETR.CALDAIA 600CC VENDING

Model Machine

MACSAE160

CRISTALLO 400 EVO(10004761)

MACSAE160.T.0011

TAVOLA NR. 11 - ARTICOLO CRISTALLO 400 EVO(10004761)

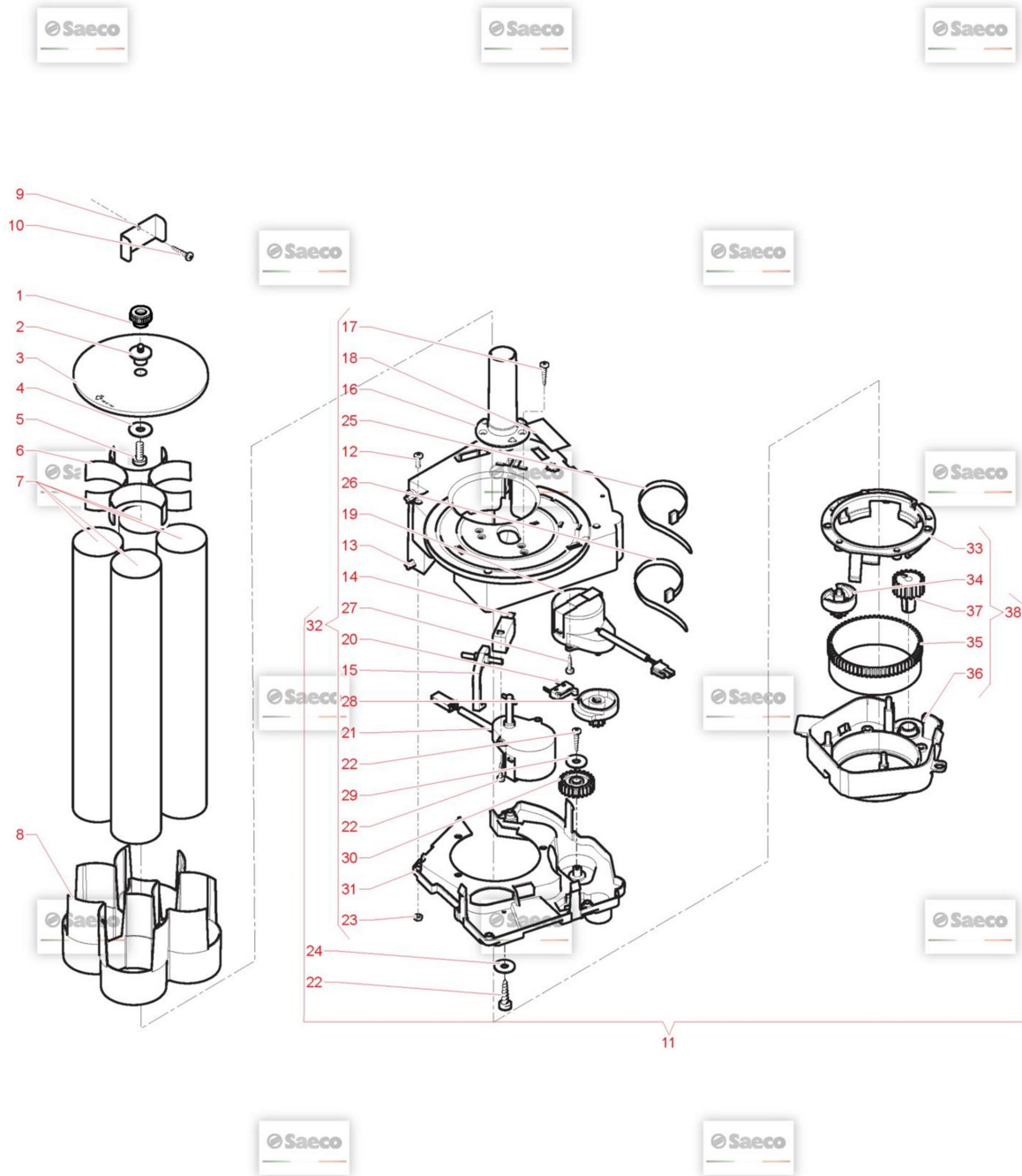

Model Machine

MACSAE160

CRISTALLO 400 EVO(10004761)

Web Pos. Foto Item - Replace by Description



Press - CTRL + CLICK go to item in a new window

Натисніть - Ctrl + права кнопка миші щоб відкрити запчастину в новому вікні



1



12002034

KNOB WITH BUSH M5
KNOB WITH BUSH M5



2



11010585

CENTRAL PIN FOR CUP COLUMN
CENTRAL PIN FOR CUP COLUMN



3



11028032

TANK LID GLASSES
TANK LID GLASSES



4

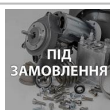

U207.009

PLAIN WASHER 5,5X15 UNI 6593 GA
PLAIN WASHER 5,5X15 UNI 6593 GA



5



U043.021

SCREW TCBC M5,0X8 UNI 7687 GALV.
VITE TCBC M5,0X8 UNI 7687 ZNP



6



11005072

CUP TUBE FIXING SPRING
CUP TUBE FIXING SPRING



7



1863.054

CUP TUBE
TUBO BICCHIERI



8



11000976

TANK DRINKS
SERBATOIO BICCHIERI UNIFICATO



9

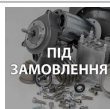

1813.162

BRACKET STOP DISPENSER
BRACKET STOP DISPENSER



10



U110.004

SCREW AUT.TCB 3,5X6,5 DIN 7981F
VITE AUT.TCB 3,5X6,5 DIN 7981 F NIK



11

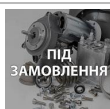

11004750

ASS. CUP DISPENSER 120V D.73
ASS. CUP DISPENSER 120V D.73



11

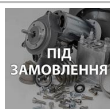

11009152

CRISTALLO400 ASSEMBLED DISPENSER D.73
CRISTALLO400 ASSEMBLED DISPENSER D.73



11

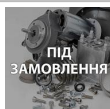





























9110.140.A2A

CUP DISTRIBUTOR
ASS.DISTRIBUTORE BICCHIERI FS400

Model Machine

MACSAE160























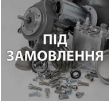

CRISTALLO 400 EVO(10004761)

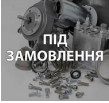
	12		U034.001	SCREW TCI M3,0X30 UNI 6107 GALV. <i>VITE TCI M3,0X30 UNI 6107 ZNP</i>
	13		11000785	ВЕРХНІЙ КОРПУС БЛОКУ ВИДАЧІ СТАКАНІВ <i>CORPO SUPERIORE DISTRIBUTORE BICCHIERI</i>
	13		11000868	CASING UPPER CUP DISTRIBUTOR UL <i>CASING UPPER CUP DISTRIBUTOR UL</i>
	14		NE05.065	MICROSWITCH CHERRY D41R-QGAD_61 <i>MICROINTERRUTTORE CHERRY D419Q1A ATLANTE CRISTALLO NEXTAGE</i>
	15		1813.067.A20	LEVER <i>LEVA PRESENZA BICCHIERI</i>
	16		11000642	TUBE FOR BASKET GLASSES <i>CANOTTO PER CESTELLO BICCHIERI</i>
	17		U142.008	PANELVIT TSP 3,5X12 DIN 7505 AGAL <i>PANELVIT TSP 3,5X12 DIN 7505 A GAL</i>
	18		11001467	ADHESIVE LABEL PVC 54X30 MM <i>ADHESIVE LABEL PVC 54X30 MM</i>
	19		9121.226.00A	MOTOR SAIA UDS 5 RPM 220V <i>MOTORE SAIA UDS 5 RPM 220V</i>
	19		9121.226.00F	RATIOMOTOR SAIA UDS 5RPM 120V60HZ <i>RATIOMOTOR SAIA UDS 5RPM 120V 60HZ</i>
	20		NE05.064	MICROSWITCH SAIA V4NC <i>MICROINTERRUTTORE SAIA V4NC</i>
	21		11000391	MOTOR SAIA UDS1ND5M75CAN2WZ239 <i>MOTORE SAIA UDS1ND5M75CAN2WZ239</i>
	21		11000481	MOTOR SAIA CUP DISPENSER D6 PIVOT 120V <i>MOTOR SAIA CUP DISPENSER D6 PIVOT 120V</i>
	22		U116.005	SCREW AUT.PT TCB 3,0X8 WN 1441 <i>VITE AUT.PT TCB 3,0X8 WN 1441 ZNP</i>

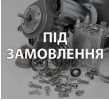
Model Machine

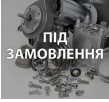
MACSAE160









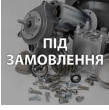

CRISTALLO 400 EVO(10004761)

	23		U324.005	NUT M3 FLANGED INDENTED BASE <i>DADO M3 FLANGIATO BASE DENTELLATA</i>
	24		U212.006	WASHER 3,2X11X0,5 ZNP <i>WASHER 3,2X11X0,5 ZNP</i>
	25	 ПІД ЗАМОВЛЕННЯ	NF11.002	SELF LOCK STRIP W=2.5 L=98 <i>SELF LOCK STRIP W=2.5 L=98</i>
	26	 ПІД ЗАМОВЛЕННЯ	144320200	SELF LOCK STRIP W=2.6 L=200 <i>SELF LOCK STRIP W=2.6 L=200</i>
	27		U109.005	SCREW AUT.TCB 3,5X16 DIN 7981C <i>VITE AUT.TCB 3,5X16 DIN 798</i>
	28		1863.066.A20	DISENGAGE CAM GLASSES <i>DISENGAGE CAM GLASSES</i>
	29		U201.001	PLAIN WASHER 3,2X9 DIN 7349 GALV. <i>PLAIN WASHER 3,2X9 DIN 7349 GALV.</i>
	30	 ПІД ЗАМОВЛЕННЯ	1813.068.A20	TOOTHED WHEEL <i>TOOTHED WHEEL</i>
	31	 ПІД ЗАМОВЛЕННЯ	1813.062.A20	LOWER CASING DISPENSER GLASSES <i>LOWER CASING DISPENSER GLASSES</i>
	31	 ПІД ЗАМОВЛЕННЯ	1813.308.050	LOVER CASING DISPENSER GLASSESUL <i>LOVER CASING DISPENSER GLASSES UL</i>
	32	 ПІД ЗАМОВЛЕННЯ	11003955	FS400 UL ASSEMBL.CUP DISP. GROUP <i>FS400 UL ASSEMBL.CUP DISP. GROUP</i>
	32	 ПІД ЗАМОВЛЕННЯ	9110.151.A2A	DISPENSER ASS. <i>DISPENSER ASS.</i>
	33	 ПІД ЗАМОВЛЕННЯ	11000786	RETAINING RING <i>RETAINING RING</i>

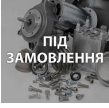
Model Machine

MACSAE160

CRISTALLO 400 EVO(10004761)

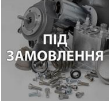
	34		1813.072.A20	SNAIL FOR GLASSES D.70 <i>CHIOCCIOLA X BICCHIERI</i>
	35		1813.073.A20	TOOTHED WHEEL FOR SNAIL <i>TOOTHED WHEEL FOR SNAIL</i>
	36		11000833	SNAIL SUPPORT <i>SNAIL SUPPORT</i>
	37		1813.074.A20	TOOTHED WHEEL <i>TOOTHED WHEEL</i>
	38		11000835	ASS.SNAIL SUPPORT <i>ASS.SNAIL SUPPORT</i>
	38		11000863	ASSEMBLY SUPPORT <i>ASSEMBLY SUPPORT</i>

Model Machine

MACSAE160

CRISTALLO 400 EVO(10004761)

MACSAE160.T.0012

TAVOLA NR. 12 - ARTICOLO CRISTALLO 400 EVO(10004761)

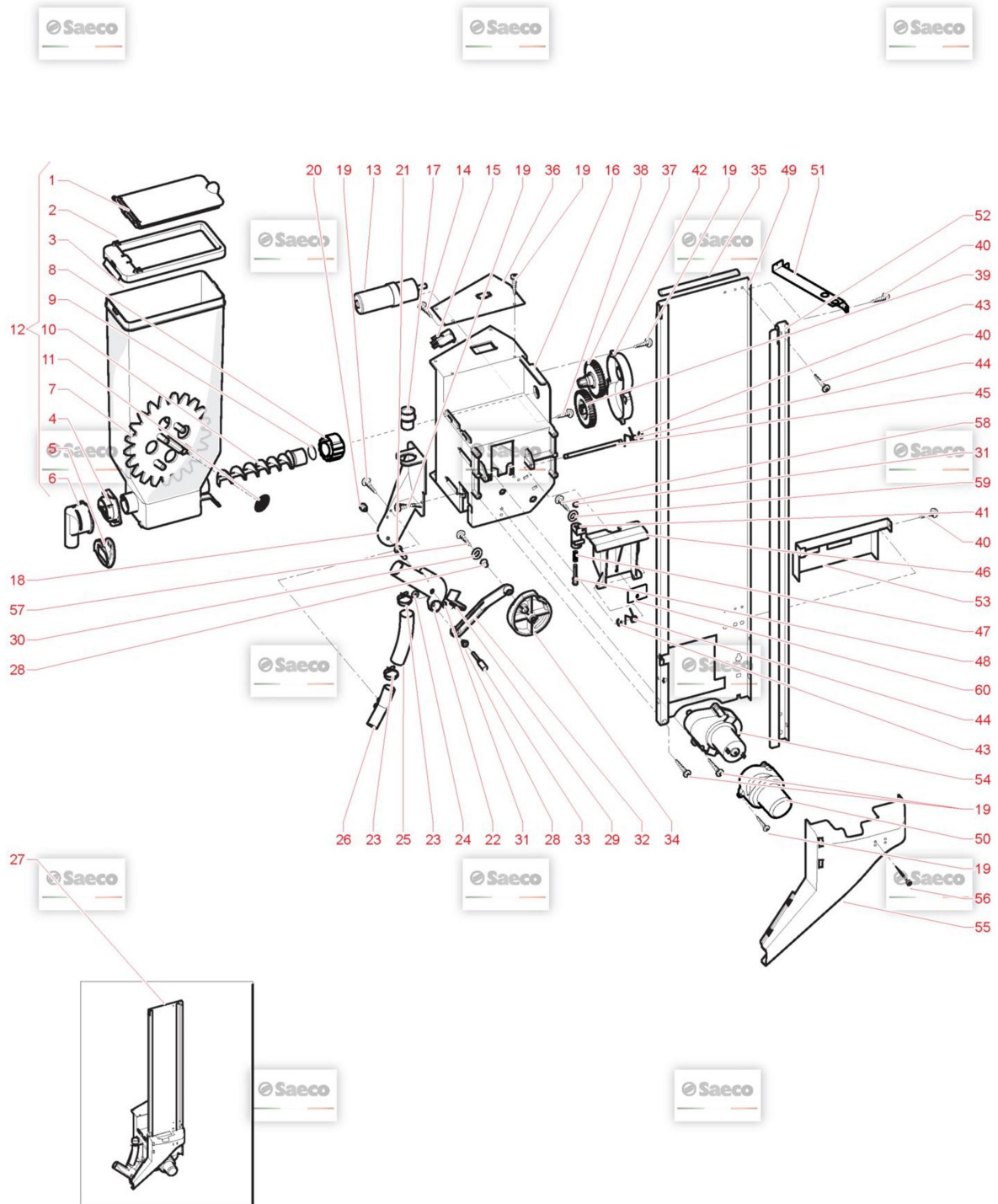

Model Machine

MACSAE160

CRISTALLO 400 EVO(10004761)

Web Pos. Foto Item - Replace by Description



Press - CTRL + CLICK go to item in a new window

Натисніть - Ctrl + права кнопка миші щоб відкрити запчастину в новому вікні



1



9111.683

SOLUBLE COVER

COPERCHIETTO SOLUBILI



2



9111.696

COVER SUGAR CONTAINER

COPERCHIO CONTENITORE ZUCCHERO



3



9111.685

SUGAR CONTAINER

CONTENITORE ZUCCHERO



4



9111.630.060

BUSH FOR POWDERS TANK

BOCCOLA X SERBAT.POLVERI C/AGGANCI



5



9111.338.270

BULKHEAD FOR APERT. CLOSURE ORANGE

PARATIA CHIUSURA BOCCHETTA ARANCIO



6



9111.629.060

APERTURE FOR SOLUBLES HOPPER

APERTURE FOR SOLUBLES HOPPER



7



11032878

ШЕСТЕРНЯ КОНТЕЙНЕРА ДЛЯ ЦУКРУ (EX 9111.725)

CONTAINER WHEEL SUGAR BPA FREE



8



11012130

BACK BUSH REINFORCE

BACK BUSH REINFORCE



9



NM03.013

OR 2,3X15 NBR

OR 2,3X15 NBR



10



9111.726

SCROLL SCREW SUGAR CONTAINER

COCLEA CONTENITORE ZUCCHERO



11

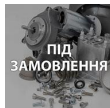

9111.646

ADHESIVE FOR TANK

ADHESIVE FOR TANK



12



9110.137

КОНТЕЙНЕР ДЛЯ ЦУКРУ SAECO

ASS. CONTENITORE ZUCCHERO



13



9121.106.00P











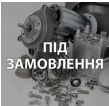















SUGAR RATIOMOTOR 24V DC

MOTORIDUTTORE ZUCCHERO 24V D.C.

Model Machine

MACSAE160



















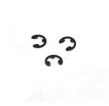





CRISTALLO 400 EVO(10004761)

	14	 ПІД ЗАМОВЛЕННЯ	U110.007	SCREW AUT.TCB 2,9X16 DIN 7981F ZNP <i>SCREW AUT.TCB 2,9X16 DIN 7981 F ZNP</i>
	15		NE05.002	МІКРОВИМИКАЧ ДЛЯ КАВОМАШИНИ EF83161.8 <i>MICROINTERRUTTORE</i>
	16		11033196	СУПОРТ МЕХАНІЗМА МЕШАЛКИ САХАРА <i>SUPP.PALETTIERA</i>
	17		9111.699	ПЕРЕХОДНИК-ДЕРЖАТЕЛЬ ДЛЯ ТРУБКИ ВИДАЧИ САХАРА КОФЕМАШИ... <i>BOCCHETTA TUBO ZUCCHERO</i>
	18		9111.686.A20	SUPPORT SUGAR CONVEYER <i>SUPPORTO BASCULINA ZUCCHERO</i>
	19		U116.006	SCREW AUT.PT TCB 3,5X12 WN 1441 ZNP <i>VITE AUT.PT TCB 3,5X12 WN 1441 ZNP</i>
	20		11000388	KNOB M3 SUGAR CONVEYER <i>POMELLO M 3 BASCULINA ZUCCHERO</i>
	21		11000389	GRAINED PIVOT SUGAR COVEYER <i>PERNO ZIGRINATO BASCULINA ZUCCHERO</i>
	22		9111.690	SUGAR CONVEYER <i>BASCULINA ZUCCHERO</i>
	23	 ПІД ЗАМОВЛЕННЯ	9111.553	SELF-ENERGIZING SPRING FOR TUBE D.2 <i>SELF-ENERGIZING SPRING FOR TUBE D.2</i>
	24		123160302	NUT M3 HIGH UNI 5587 GALVANIZED <i>NUT M3 HIGH UNI 5587 GALVANIZED</i>
	25		9111.700	SUGAR TUBE <i>TUBO ZUCCHERO</i>
	26		9111.697	CONNECTOR SUGAR TUBE <i>RACCORDO TUBO ZUCCHERO</i>
	27	 ПІД ЗАМОВЛЕННЯ	11033212	SUGAR/SPOONS DISPENDER 120V 25RPM UL <i>ASS.DISTR.PALETTE/ZUCCH.120V 25RPM UL</i>

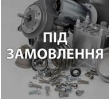
Model Machine

MACSAE160



























CRISTALLO 400 EVO(10004761)

	27		11033213	DISPENCER STIRRER /SUGAR 25RPM <i>DISPENCER STIRRER /SUGAR 25RPM</i>
	28		9111.705	SPHERICAL PIN <i>PERNO SFERICO</i>
	29		9111.727	BULKHEAD SUGAR CONVEYER <i>PARATIA BASCULINA ZUCCHERO</i>
	30		U201.001	PLAIN WASHER 3,2X9 DIN 7349 GALV. <i>PLAIN WASHER 3,2X9 DIN 7349 GALV.</i>
	31		U701.011	STEEL SNAP RING 5 UNI 7434 <i>ANELLO ELASTICO 5 UNI 7434</i>
	32		9111.691	CONNECTING ROD SUGAR DISPENCER <i>BIELLA DISTRIBUTORE ZUCCHERO</i>
	33		11004295	KNOB FOR SUGAR CONNECTING RODPIPE <i>POMELLO BLOCCAGGIO BIELLA TUBO ZUCCH.</i>
	34		9111.688.A20	CAM SUGAR DISPENCER <i>CAMMA DISTRIBUTORE ZUCCHERO</i>
	35		9111.668	STIRRER DISP.COUNTERWEIGHT D.10 <i>CONTRAPPESO PALETTE D.10</i>
	35		9111.669	STIRRER DISP.COUNTERWEIGHT D.10 <i>STIRRER DISP.COUNTERWEIGHT D.10</i>
	35		9111.745	STIRRER DISP.COUNTERWEIGHT <i>CONTRAPPESO PALETTE L=113MM</i>
	36		9111.707	REINFORCING PLATE <i>PIASTRA RINFORZO PALETTIERA</i>
	37		9111.694	JOINT WITH GEAR <i>GIUNTO CON INGRANAGGIO</i>

Model Machine

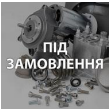
MACSAE160











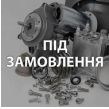





CRISTALLO 400 EVO(10004761)

	38		U116.005	SCREW AUT.PT TCB 3,0X8 WN 1441 VITE AUT.PT TCB 3,0X8 WN 1441 ZNP
	39		9111.695	GEAR Z40 INGRANAGGIO Z 40
	40		U110.004	SCREW AUT.TCB 3,5X6,5 DIN 7981F VITE AUT.TCB 3,5X6,5 DIN 7981 F NIK
	41		9111.737	ОПОРА ТРУБКА ПЛАСТИКОВАЯ SUPPORT
	42		9111.687.A20	GEAR COVER COPERCHIO INGRANAGGI
	43		U701.006	ФІКСУЮЧА СКОБА 3,2 (ЗАПІЗО) SAECO ANELLO ELASTICO 3,2
	44		9111.730	SPRING MOLLA ESPULSORE PALETTE
	45		9111.376	PIN FOR STIRRER EXPELLER PIN FOR STIRRER EXPELLER
	46		11011240	STIRRER EXPELLER BLACK NEW STIRRER EXPELLER BLACK NEW
	47		11031341	SPRING SPRING
	48		11002209	PIN PIN
	49		11009886	STIRRER GUIDE CRISTALLO400 NEW STIRRER GUIDE CRISTALLO400 NEW
	50		11025411	CRISTALLO SPOON'S MOTOR COVER CRISTALLO SPOON'S MOTOR COVER
	51		11032949	BRACKET FOR STIRRER GUIDE FS4N BRACKET FOR STIRRER GUIDE FS4N

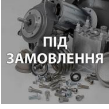
Model Machine

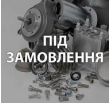
MACSAE160

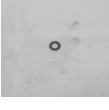
CRISTALLO 400 EVO(10004761)

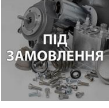
	52		9111.693	STIRRER GUIDE <i>STIRRER GUIDE</i>
	53		11007444	CARTER <i>CARTER</i>
	54		11033191	GEARMOTOR MECHTEX 25 RPM <i>MOTORIDUTTORE MECHTEX 25 RPM</i>
	55		9111.698.A20	STIRRER SLIDE <i>SCIVOLO PALETTE</i>
	56		9161.082	RUBBER COUPLER <i>AGGANCIO IN GOMMA</i>
	57		U116.004	SCREW AUT.PT TCB 3,0X16 WN 1441 <i>SCREW AUT.PT TCB 3,0X16 WN 1441</i>
	58		U117.003	SCREW AUT.PT TCB 2.5X10 WN 1442 <i>SCREW AUT.PT TCB 2.5X10 WN 1442</i>
	59		U207.003	PLAIN WASHER 3,2X7 UNI 6592 GALV. <i>PLAIN WASHER 3,2X7 UNI 6592 GALV.</i>
	60		11025089	PLATE REINFORCEMENT <i>PIASTRINA RINFORZO ESPULSORE</i>

Model Machine

MACSAE160

CRISTALLO 400 EVO(10004761)

MACSAE160.T.0013

TAVOLA NR. 13 - ARTICOLO CRISTALLO 400 EVO(10004761)

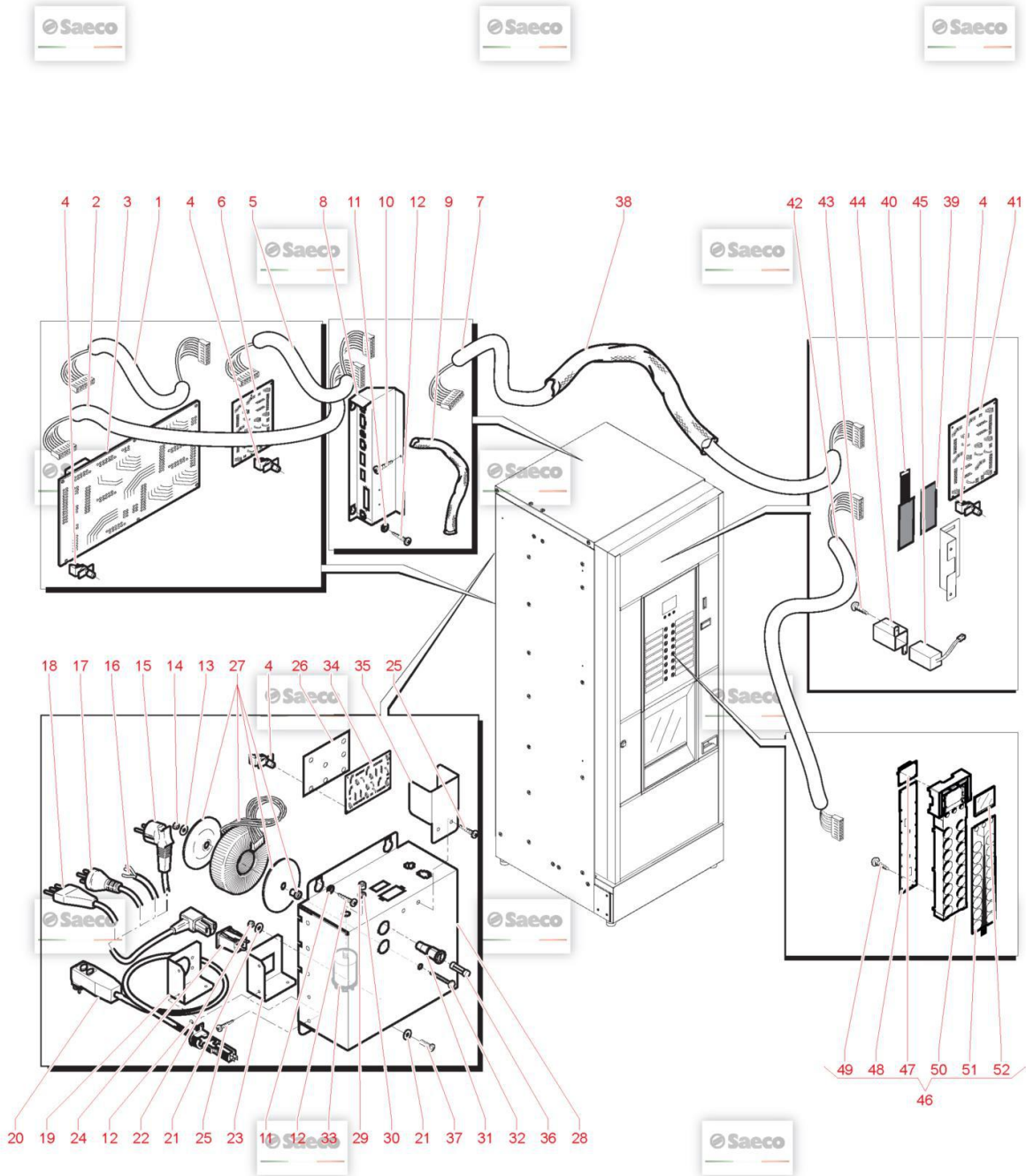

Model Machine

MACSAE160

CRISTALLO 400 EVO(10004761)

Web Pos. Foto Item - Replace by Description



Press - CTRL + CLICK go to item in a new window

Натисніть - Ctrl + права кнопка миші щоб відкрити запчастину в новому вікні



1

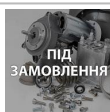

11033852

FLAT 24P PW BOARD / CAPS BOARD CRS EVO
FLAT 24P SCHEDA PW/SCHEDA CAPS CRS EVO



2



1863.604

HARNESS
FLAT CABLE



3



1863.636

POWER CARD FS400
SCHEDA POWER FS400



4



9111.402

SPACER FOR CARD
SPACER FOR CARD



5

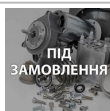

11033853

FLAT 24P EXTENSION CAPS BOARD CRS EVO
FLAT 24P EXTENSION CAPS BOARD CRS EVO



6

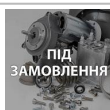

11033815

CAPSULE POWER BOARD
CAPSULE POWER BOARD



7

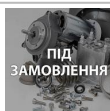

11006679

FLAT CABLE EXTEND CPU/IO
FLAT CABLE EXTEND CPU/IO



8

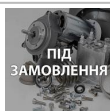

1863.070

BOX
BOX



9



11001619

CABLE TUBE L.520 MM
GUAINA X CAVI L.520 MM



10



U109.003

SCREW TCB 3,5X9,5 DIN 7981 C NICK
SCREW TCB 3,5X9,5 DIN 7981 C NICK



11

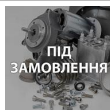

11011054

PIN FOR BOSS D.8
PIN FOR BOSS D.8



12



U110.005

SCREW AUT.TCB 3,9X9,5 DIN 7981F
VITE AUT.TCB 3,9X9,5 DIN 798



13

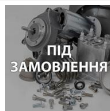





























U207.013

PLAIN WASHER 6.5X18 UNI 6592 GALV
PLAIN WASHER 6.5X18 UNI 6592 GALV

Model Machine

MACSAE160

















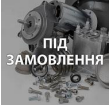





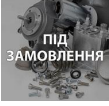

CRISTALLO 400 EVO(10004761)

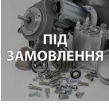
	14		U310.004	NUT SELF LOCK.M6 UNI 7473 <i>NUT SELF LOCK.M6 UNI 7473</i>
	15		NE01.050	CABLE SCHUKO WITH PLUG EN60320C1 <i>CAVO SCHUKO CON SPINA EN60320 C13</i>
	16		NE01.054	CABLE WITH PLUG EN60320 C13 <i>CABLE WITH PLUG EN60320 C13</i>
	17		NE01.053	CABLE AUSTRAL. +PLUG EN60320 C13 <i>CABLE AUSTRAL. +PLUG EN60320 C13</i>
	17		NE01.093	CABLE ARGENTINA + PLUG EN60320C13 <i>CABLE ARGENTINA + PLUG EN60320 C13</i>
	18		17800019	BLACK POWER CABLE BRAZIL L=1200 <i>BLACK POWER CABLE BRAZIL L=1200</i>
	18		NE01.051	CABLE SWITZERLAND WITH PLUG EN603 <i>CABLE SWITZERLAND WITH PLUG EN603</i>
	19		11003906	USA CABLE SUPPORT ELECTRONIC PARTS BOX <i>USA CABLE SUPPORT ELECTRONIC PARTS BOX</i>
	20		11012009	POWER CABLE USA 3 POLE 15A X GFC8 <i>POWER CABLE USA 3 POLE 15A X GFC8</i>
	21		U208.003	TOOTHED WASHER 5,1X9 BRU <i>TOOTHED WASHER 5,1X9 BRU</i>
	22		U302.003	МЕТАЛЕВА ГАЙКА M4 UNI 5588 ZNP <i>DADO ESAGONALE M4 UNI 5588 ZNP</i>
	23		11000546	POWER CONNECTOR SUPPORT <i>SQUADRETTA X PRESA VASCHETTA</i>
	24		187850400	TRIPOLE SOCKET SELF-LOCKING <i>TRIPOLE SOCKET SELF-LOCKING</i>
	25		U110.003	SCREW AUT.TCB 3,5X9,5 DIN 7981F <i>VITE AUT.TCB 3,5X9,5 DIN 798</i>

Model Machine

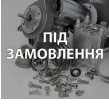
MACSAE160















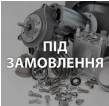











CRISTALLO 400 EVO(10004761)

	26		11012747	CARD PROTECTION LED ATLANTE <i>CARD PROTECTION LED ATLANTE</i>
	27		NE19.023	TOROIDAL TRANSFORMER COMBI 240V <i>TOROIDAL TRANSFORMER COMBI 240V</i>
	27		NE19.028	TOROIDAL TRANSFORMER FS 400 <i>TRASFORMATORE TOROIDALE FS 400</i>
	28		1863.045	ASPIRATION CASING FOR MIXER <i>ASPIRATION CASING FOR MIXER</i>
	29		U302.007	NUT HEXAGONAL M8 UNI 5588 <i>NUT HEXAGONAL M8 UNI 5588</i>
	30		U208.009	TOOTHED WASHER 8,4X15 UNI 3703 <i>TOOTHED WASHER 8,4X15 UNI 3703</i>
	31		NE13.016	FUSE HOLDER WITH SCREW ON CAP <i>PORTAFUSIBILE CON TAPPO A VITE</i>
	32		U005.013	SCREW TE M6,0X70 UNI 5739 GALV. <i>SCREW TE M6,0X70 UNI 5739 GALV.</i>
	33		184651500	LOCKING SCREW ANTIDISTURB FILTER 16A <i>LOCKING SCREW ANTIDISTURB FILTER 16A</i>
	34		11030270	ATLANTE LED POWER SUPPLY <i>ATLANTE LED POWER SUPPLY</i>
	35		11003867	SAFETY PLATE FOR EL.BOX CONNECTOR <i>SAFETY PLATE FOR EL.BOX CONNECTOR</i>
	36		NE13.002	FUSE 6,3X32 8A 250V DELAYED <i>FUSE 6,3X32 8A 250V DELAYED</i>
	36		NE13.081	FUSE 6,3X32 16A 250V DELAYED UL <i>FUSIBILE 6,3 X 32 15A 250V RITARD UL SOLO UL</i>

Model Machine

MACSAE160

CRISTALLO 400 EVO(10004761)

	37		12002039	SCREW TCBD TORX 20 M4X12 ZN-B VITE TCBD TORX 20 M4X12 ZN-B
	38		11003521	620MM CABLE TUBE GUAINA X CAVI L.780MM
	39	 ПІД ЗАМОВЛЕННЯ	0875.990	TOUCH PANEL PLATE TOUCH PANEL PLATE
	40		0875.741	TOUCH PANEL TOUCH PANEL
	41	 ПІД ЗАМОВЛЕННЯ	11033307	AS.CPU+SW CRISTALLO EVO AS.CPU+SW CRISTALLO EVO
	42	 ПІД ЗАМОВЛЕННЯ	11033778	HARNESS CPU BOARD KEYBOARD CAPACITIVE HARNESS CPU BOARD KEYBOARD CAPACITIVE
	43		U116.005	SCREW AUT.PT TCB 3,0X8 WN 1441 VITE AUT.PT TCB 3,0X8 WN 1441 ZNP
	44		9991.140.050	IMPULSECOUNTERHOLDER KEISU GX-06R PORTA CONTAIMPULSI KEISU GX-
	45		NE13.025.00P	IMPULSE COUNTER KEISU GX-06R 24V CONTAIMPULSI KEISU GX-06R 24
	46	 ПІД ЗАМОВЛЕННЯ	11032875	ILLUMINATOR 16+3 LED FS4N ILLUMINATOR 16+3 LED FS4N
	47		11032383	HW INTERF. NEW TFT DISPLAY UMSH-8252MD-T SCHEMA INTERF. DISPLAY TFT UMS H-8252MD-T CRISTALLO400/600/PHE...
	48		11032885	SCHEMA LEDS CAPACITIVA SCHEMA LEDS CAPACITIVA
	49		U116.006	SCREW AUT.PT TCB 3,5X12 WN 1441 ZNP VITE AUT.PT TCB 3,5X12 WN 1441 ZNP
	50	 ПІД ЗАМОВЛЕННЯ	11032820	DISPLAY / LED SUPPORT FS4N DISPLAY / LED SUPPORT FS4N

Model Machine

MACSAE160

CRISTALLO 400 EVO(10004761)



51

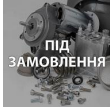

11032991

CAPACITIVE ADHESIVE CIRCUIT 19KEYS

CAPACITIVE ADHESIVE CIRCUIT 19 KEYS



52



11032399

3,5" TFT DISPLAY 320X240

3,5 TFT DISPLAY 320X240

Model Machine

MACSAE160

CRISTALLO 400 EVO(10004761)

MACSAE160.T.0014

TAVOLA NR. 14 - ARTICOLO CRISTALLO 400 EVO(10004761)

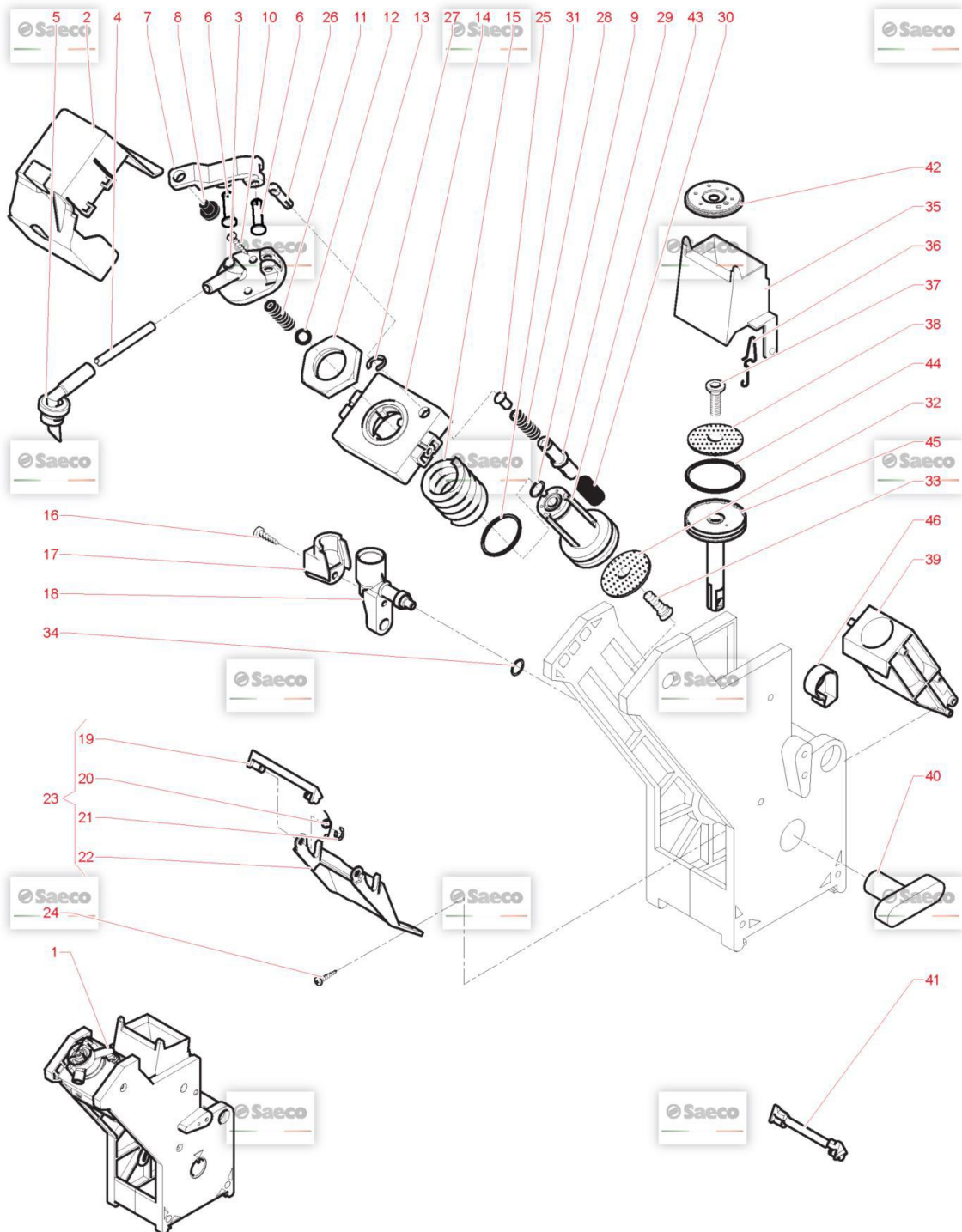

Model Machine

MACSAE160

CRISTALLO 400 EVO(10004761)

Web Pos. Foto Item - Replace by Description



Press - CTRL + CLICK go to item in a new window
Натисніть - Ctrl + права кнопка миші щоб відкрити запчастину в новому вікні



1



11030408

BREWING UNIT ASS. 7GR GRAN GUSTO
ASS. GRUPPO CAFFE 6/8GR NEW



2



11029737

PROTECTION VALVE
PROTEZIONE VALVOLA SFIATO GRUPPO CAFFE



3



11029311

COVER BALL VALVE
COPERCHIO VALVOLA SFERA



4

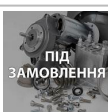

9972.345

SILICONE TUBE 3,5X9 L.340MM
SILICONE TUBE 3,5X9 L.340MM



5

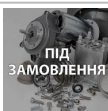

11033574

COFFEE NOZZLES
COFFEE NOZZLES



6



11030836

ШПЛИНТ ФІКСАЦІЇ СУППОРТУ КЛАПАНА
PIN FIXING VALVE SUPPORT



7



11029312

BREATHER VALVE CLOSED
CHIUSURA VALVOLA SFIATO



8



NV01.009

RUBBER BUFFER
GOMMINO PARACOLPI



9



NM01.029

OR ORM 0100-15 SILICONE
OR ORM 0100-15 SILICONE



10

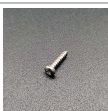

U109.006

SCREW AUT.TCB 2,2X9,5 DIN 7981C
VITE AUT.TCB 2,2X9,5 DIN 7981 C NIK



11



126771918

SS COFFEE UNIT CONTERPISTON SPRING SMART
MOLLA CONTROPIST. GRUP. SMART INOX



12



12001811

SPHERE TEFLON D.4,5
SFETA D.4.5 TEFLON X VALVOLA GRUPPO CAFF



13































11029317

NUT SEAL PISTON MOVABLE
DADO TENUTA CONTROPISTONE MOBILE

Model Machine

MACSAE160



























CRISTALLO 400 EVO(10004761)

	14		11029316	FLANGE FOR CUPHOLDER <i>FLANGIA X PISTONE MOBILE</i>
	15		11029308	SPRING FOR MOVABLE COUNTERPISTON <i>MOLLA X CONTROPISTONE MOBILE</i>
	16		129512921	SCREW TCB TORX 10 AB 2,9X13 SHEET SS <i>SCREW TCB TORX 10 2,9X13 SHEET SS</i>
	17		11010013	CARTER FOR MUFF PREHEATING UNIT <i>CARTE X MANICOTTO GRUPPO PRERISCALDO</i>
	18		11005371	UNIT COFFEE MUFF <i>MANICOTTO GRUPPO CAFFE' UNIT COFFEE MUFF</i>
	19		9111.537.060	BROWN SCRAPER COFFEE GROUP <i>BROWN SCRAPER COFFEE GROUP</i>
	20		9111.520	SPRING FOR SCRAPER SECTION 0.6 <i>SPRING FOR SCRAPER SECTION 0.6</i>
	21		U701.006	ФІКСУЮЧА СКОБА 3,2 (ЗАПІЗО) SAECO <i>ANELLO ELASTICO 3,2</i>
	22		9111.539.060	FORK FOR SCRAPER <i>FORCELLA PER RASCHIATORE</i>
	23		9110.067.060	SCRAPER ASS.FOR CAPPUCINAT. TUBE <i>ASS.RASCHIATORE X SG500/700</i>
	24		U110.013	БОЛТ МЕТАЛЕВИЙ 3,9X6,5 DIN 7981 F <i>SCREW AUT.TCB 3,9X6,5 DIN 7981 F</i>
	25		9161.320	VALVE FOR UNIT <i>VALVOLA X GRUPPO CAFFE'</i>
	26		11029313	CURSOR COMPENSATOR VALVE VENT <i>CURSORE COMPENSATORE X VALVOLA SFIATO</i>
	27		U701.007	ЕЛАСТИЧНЕ КІЛЬЦЕ 6 UNI 7434 (ЗАПІЗО) <i>ЕЛАСТИЧНЕ КІЛЬЦЕ 6 UNI 7434 (ЗАПІЗО)</i>

Model Machine

MACSAE160









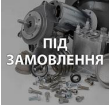

CRISTALLO 400 EVO(10004761)

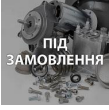
	28		11029310	SPRING FOR RELIEF VALVE <i>MOLLA COMPENSATRICE X VALVOLA SFIATO</i>
	29		11029314	CURSOR FOR VALVE VENT <i>CURSORE X VALVOLA SFIATO</i>
	30		11029309	SPRING FOR RELIEF VALVE <i>MOLLA X VALVOLA SFIATO</i>
	31		140322061	O-RING 4112 EPDM <i>OR 4112 IN EPDM</i>
	32		11012630	PERCOLATOR D.34 <i>PERCOLATOR D.34</i>
	33		U044.009	SS SCREW TSPC M3,0X8 UNI 7688 <i>VITE TSCP M3,0X8 UNI 7688 INO</i>
	34		140321462	O-RING 2018 SILICONE <i>OR 2018 IN SILICONE</i>
	35		322001201	MOBILE SCRAPER BROWN NARROW <i>MOBILE SCRAPER BROWN NARROW</i>
	36		9161.425	SPRING FOR SCRAPER <i>SPRING FOR SCRAPER</i>
	37		129851921	TSP SCREW M3X6 UNI 7688 SS <i>TSP SCREW M3X6 UNI 7688 SS</i>
	38		324000200	SS PERCOLATOR D=34 FOR UNIT <i>SS PERCOLATOR D=34 FOR UNIT</i>
	39		222711101	BROWN GROUND COFF.CONTAINER D=36 ASSY. <i>BROWN GROUND COFF.CONTAINER D=36 ASSY.</i>
	40		9161.021.060	KEY FOR BREW UNIT BROWN <i>CHIAVE X GRUPPO CAFFE' MARRO</i>

Model Machine

MACSAE160

CRISTALLO 400 EVO(10004761)

	41		11012957	SCRAPER FOR COFFEE UNIT 7-9GR. <i>SCRAPER FOR COFFEE UNIT 7-9GR.</i>
	42		11030122	SPACE <i>SPACE</i>
	43		11029878	ASS.CONTROPISTONE MOBILE <i>ASS.CONTROPISTONE MOBILE</i>
	44		140322500	ПРОКЛАДКА O-RING 2118 SH70 BIANCHI 36363116-01, SAECO 140322500 <i>OR 2118 IN NITRIL RUBBER</i>
	45		11029879	ПОРШЕНЬ РОБОЧОГО БЛОКУ X 7 ГРАМ <i>ASS.PISTONE X GRUPPO CAFFE'</i>
	46		11030309	RING FOR CAM <i>ANELLO X CAMMA PISTONE</i>

Model Machine

MACSAE160

CRISTALLO 400 EVO(10004761)

MACSAE160.T.0015

TAVOLA NR. 15 - ARTICOLO CRISTALLO 400 EVO(10004761)

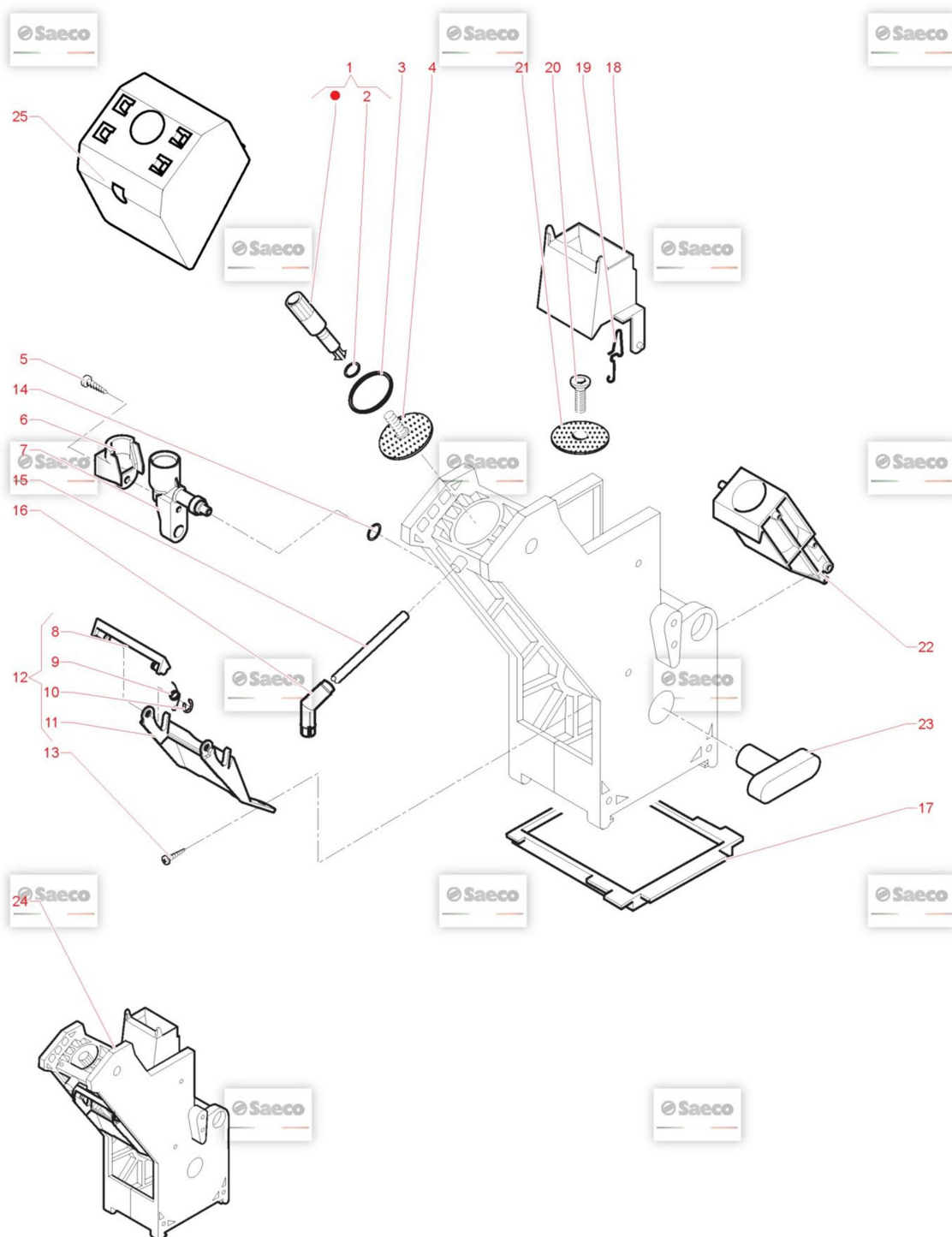

Model Machine

MACSAE160

CRISTALLO 400 EVO(10004761)

Web Pos. Foto Item - Replace by Description



Press - CTRL + CLICK go to item in a new window
Натисніть - Ctrl + права кнопка миші щоб відкрити запчастину в новому вікні



1



9169.A14.150

PIN FOR PERCOLATOR GREY
ASS.PERNO X DOCCIA COMPLETO GRIGIO



2



NM02.006

OR R5 TERMOIL
OR R5 EPDM



3



NM01.044

OR ORM 0320-40 SILICONE PTFE/FDA
OR ORM 0320-40 SILICONE PTFE



4



9161.036

UPPER PERCOLATOR FOR UNIT
DOCCIA SUPERIORE X GRUPPO



5



129512921

SCREW TCB TORX 10 AB 2,9X13 SHEET SS
SCREW TCB TORX 10 2,9X13 SHEET SS



6



11010013

CARTER FOR MUFF PREHEATING UNIT
CARTE X MANICOTTO GRUPPO PRERISCALDO



7



11005371

UNIT COFFEE MUFF
MANICOTTO GRUPPO CAFFE' UNIT COFFEE MUFF



8



9111.537.150

GREY SCRAPER COFFEE GROUP
GREY SCRAPER COFFEE GROUP



9



9111.520

SPRING FOR SCRAPER SECTION 0.6
SPRING FOR SCRAPER SECTION 0.6



10



U701.006

ФІКСУЮЧА СКОБА 3,2 (ЗАЛІЗО) SAECO
ANELLO ELASTICO 3,2



11



9111.539.150

FORK FOR SCRAPER
FORCELLA PER RASCHIATORE



12



9110.067.150

SCRAPER ASS.FOR CAPPUCCINAT. TUBE
ASS.RASCHIATORE X SG500/700



13



























U110.013

БОЛТ МЕТАЛЕВИЙ 3,9X6,5 DIN 7981 F
SCREW AUT.TCB 3,9X6,5 DIN 7981 F

Model Machine

MACSAE160

CRISTALLO 400 EVO(10004761)

	14		140321462	O-RING 2018 SILICONE <i>OR 2018 IN SILICONE</i>
	15		9972.057	КОРИЧНЕВА ГУМОВА ТРУБКА 5X8 2 МЕТРИ <i>TUBO SILICONE MARRON 5X8 L.2000 MM</i>
	16		9111.349	ELBOW DISPENSING NOZZLE <i>UGELLO EROGAZIONE GOMITO</i>
	17		9161.020.060	PLATE FOR COFFEE UNIT BROWN <i>PLATE FOR COFFEE UNIT BROWN</i>
	18		322001259	ПЛАСТИКОВА ВОРНОКА ПОДАЧИ КАВИ (ПЛАСТИК) ЧОРНИЙ <i>MOBILE SCRAPER GREY NARROW</i>
	19		9161.425	SPRING FOR SCRAPER <i>SPRING FOR SCRAPER</i>
	20		129851921	TSP SCREW M3X6 UNI 7688 SS <i>TSP SCREW M3X6 UNI 7688 SS</i>
	21		9161.037	LOWER PERCOLATOR FOR UNIT <i>DOCCIA INFERIORE X GRUPPO</i>
	22		11002626	ASS. COFFEE CONTAINER GREY 9 GR. <i>ASS. COFFEE CONTAINER GREY 9 GR.</i>
	23		9161.021.060	KEY FOR BREW UNIT BROWN <i>CHIAVE X GRUPPO CAFFE' MARRO</i>
	24		11005422	ЗАВАРЮВАЛЬНИЙ БЛОК 9GR SAECO 996530002882 <i>GRUPPO CAFFE' 9GR CRISTALLO 600</i>
	25		11013053	CARTER FOR DOSER UNIT <i>CARTER FOR DOSER UNIT</i>

Model Machine

MACSAE160

CRISTALLO 400 EVO(10004761)

MACSAE160.T.0016

TAVOLA NR. 16 - ARTICOLO CRISTALLO 400 EVO(10004761)

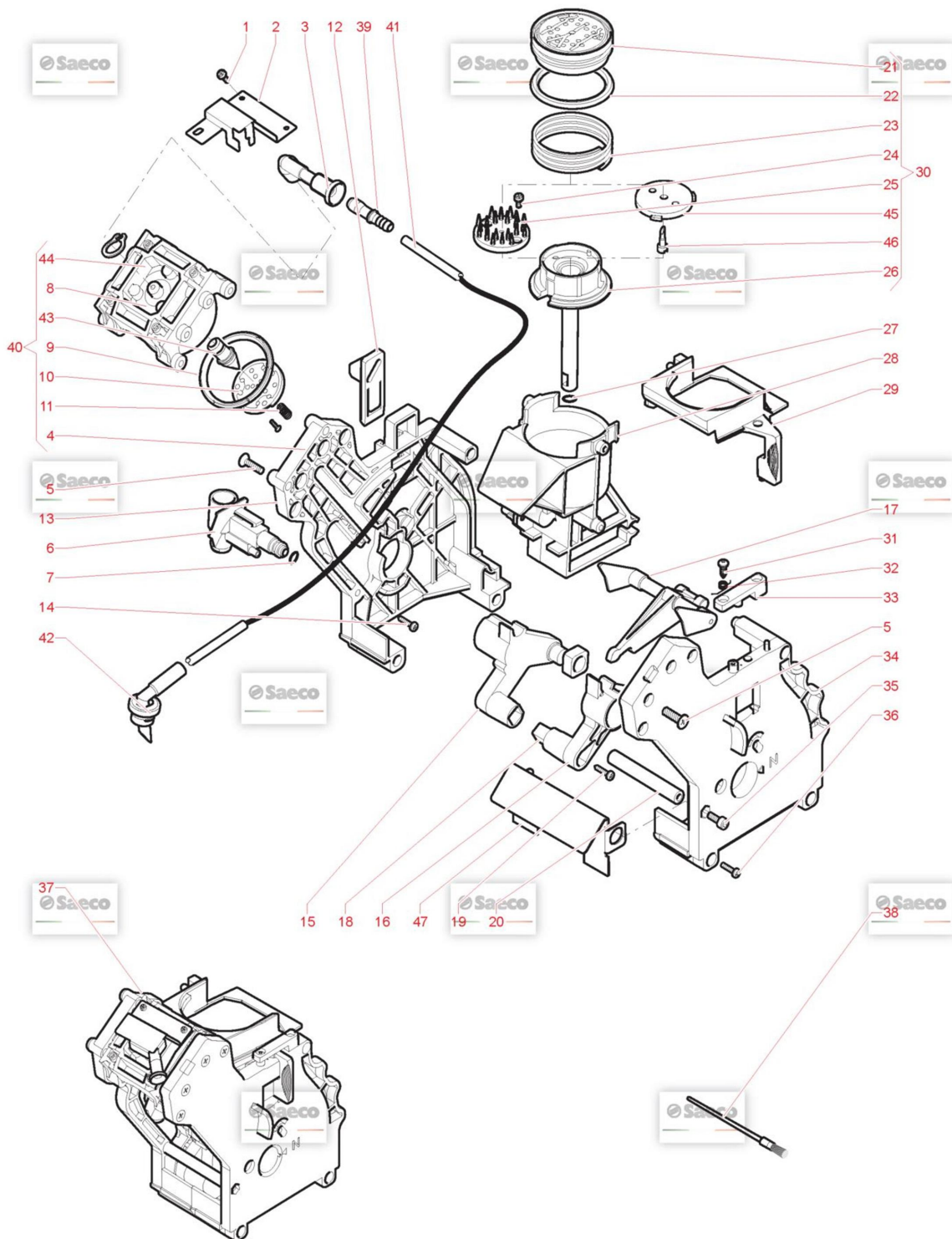















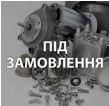

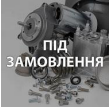









Model Machine

MACSAE160

CRISTALLO 400 EVO(10004761)

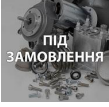
Web Pos. Foto Item - Replace by Description











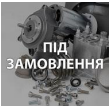

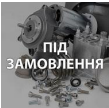













 *Press - CTRL + CLICK go to item in a new window*
Натисніть - Ctrl + права кнопка миші щоб відкрити запчастину в новому вікні

	1		129512921	SCREW TCB TORX 10 AB 2,9X13 SHEET SS SCREW TCB TORX 10 2,9X13 SHEET SS
	2		11031906	PLATE PLATE
	3		11004586	BLK COFFEE OUTLET CONVEYOR OCS BLK COFFEE OUTLET CONVEYOR OCS
	3		9161.356	BLK COFFEE OUTLET CONVEYOR LAV. BLK COFFEE OUTLET CONVEYOR LAV.
	4		129912621	SCREW PT KB 30X8 WN 1413 INOXA2 SCREW PT KB 30X8 WN 1413 INOX A2
	5		129911721	SCREW TSP TORX 4X16 PLAST STEEL SCREW TSP TORX 4X16 PLAST STEEL
	6		9161.064.150	ВХІДНИЙ КЛАПАН ЗАВАРЮВАЛЬНОГО БЛОКУ КАВОВАРКИ SAECO ПРО... MANICOTTO ENTRATA ACQUA GRUP.CAF.GRIGIO CON OR NM02.007 - F...
	7		NM02.007	OR 2025 IN TERMOIL OR 2025 TERMOIL
	8		11013418	BLK COFF.CAPSULE FIXED CONTAINER V3 LAV. BLK COFF.CAPSULE FIXED CONTAINER V3 LAV.
	8		11034351	BLK COFF.CAPSULE FIXED CONTAINER CONT.FISSO CAPS LAVORATO CO BLK
	8		421941306941	CONT.FISSO CAPS.CAF.ATL700 CAGRI. GREY COFFEE CAPS.FIXED CONTAINER ATL700
	9		11031760	SEAL FOR BREW UNIT CAPS SEAL FOR BREW UNIT CAPS
	9		421941306911	SEAL FOR BREW UNIT CAPS CA SEAL FOR BREW UNIT CAPS CA

Model Machine

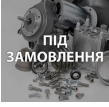
MACSAE160

















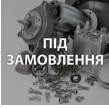





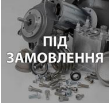

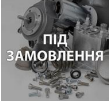
CRISTALLO 400 EVO(10004761)

	10		11031226	PIERCER GROUP CAPS <i>PIERCER GROUP CAPS</i>
	11		126773518	SS SPRING FOR COFFEE CAPSULE LAV. <i>SS SPRING FOR COFFEE CAPSULE LAV.</i>
	11		421941306921	SPRING FOR STEEL PIERCE BU CAPSULE CA <i>MOLLA X FORATORE CA</i>
	12		9161.373.150	GREY BREW UNIT COUPLING PLATESMART <i>GREY BREW UNIT COUPLING PLATE SMART</i>
	13		11013396	BLACK BREW UNIT REAR PLATE V3LAV. <i>BLACK BREW UNIT REAR PLATE V3 LAV.</i>
	14		12000550	CAMOPI3 TCB TORX 10 3X25 PLAST.SS <i>SCREW TCB TORX 10 3X25 PLAST.SS</i>
	15		120080722	ALUM.FEMALE ELBOW SHAFT <i>ALUM.FEMALE ELBOW SHAFT</i>
	16		120080622	ALUM.MALE ELBOW SHAFT <i>ALUM.MALE ELBOW SHAFT</i>
	17		11032146	GREY BREW UNIT CONNECTING RODCAPS <i>GREY BREW UNIT CONNECTING ROD CAPS</i>
	18		9161.094.050	BLACK BREW UNIT DRILLED BLOCK <i>BLACK BREW UNIT DRILLED BLOCK</i>
	19		129574421	SCREW TCB PH/TT 4X20 UNI 8112ST.ST <i>SCREW TCB PH/TT 4X20 UNI 8112 ST.ST</i>
	20		9161.298	BRASS SPACER <i>BRASS SPACER</i>
	21		11011770	CASING TO MOVABLE DRILLING PLATE V3 LAV. <i>CORPO A PIATTEL.MOBILE FORATO V3 LAV.NER</i>
	21		142906059	CASING TO MOVABLE DRILLING PLATE <i>CASING TO MOVABLE DRILLING PLATE</i>

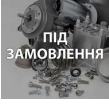
Model Machine

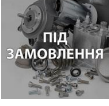
MACSAE160

















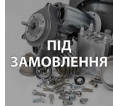

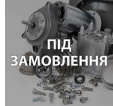

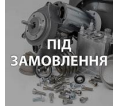

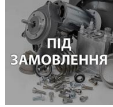

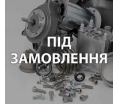

CRISTALLO 400 EVO(10004761)

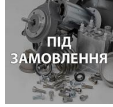
	22		11026624	LIP SEAL FOR CAPS.EXPELLER PISTON V4 LAV <i>LIP SEAL FOR CAPS.EXPELLER PISTON V4 LAV</i>
	22		145855700	LIP SEAL FOR EXPELLER PISTON OCS <i>LIP SEAL FOR EXPELLER PISTON OCS</i>
	23		126772418	COFF.CAPSULE EXPELLER PISTON SPRING LAV. <i>COFF.CAPSULE EXPELLER PISTON SPRING LAV.</i>
	23		126774118	SPIRAL SPRING FOR PISTON EXPELLER <i>SPIRAL SPRING FOR PISTON EXPELLER</i>
	24		129910921	SCREW TCB TORX 10 3X10 SS <i>SCREW TCB TORX 10 3X10 SS</i>
	25		149198000	COFFEE CAPS.LOWER DRILLING SUPPORT LAV. <i>COFFEE CAPS.LOWER DRILLING SUPPORT LAV.</i>
	26		229211859	COFFEE CAPSULE EXPELLER PISTONLAV. <i>COFFEE CAPSULE EXPELLER PISTON LAV.</i>
	26		229211959	COFFEE CAPSULE EXPELLER PISTON OCS <i>COFFEE CAPSULE EXPELLER PISTON OCS</i>
	27		NM02.018	OR ORM 0090-25 TERMOIL <i>OR ORM 0090-25 TERMOIL</i>
	28		421941306881	MOBILE CONT. BU CAPS V3 ATL 700 ASSY <i>MOBILE CONT. BU CAPS V3 ATL 700 ASSY</i>
	28		421941306901	MOBILE CONTAINER BU OCS CAPS ATL700 ASSY <i>ASS.CONT.MOBILE GRUPPO CAPS ATL700 GRY</i>
	29		11031018	HOPPER COFFEE GROUP <i>HOPPER COFFEE GROUP</i>
	30		11026626	PISTON EXPELLER COFFEE CAPSULEV4 ASSY. <i>PISTON EXPELLER COFFEE CAPSULE V4 ASSY.</i>

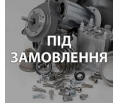
Model Machine

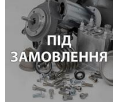
MACSAE160

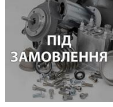
CRISTALLO 400 EVO(10004761)

	30		227661000	PISTON AS.EXPELLER COFF.CAPSULE OCS ASSY <i>PISTON AS.EXPELLER COFF.CAPSULE OCS ASSY</i>
	31		12000895	SCREW TSP TORX 10 3X10 PLAST.SS <i>SCREW TSP TORX 10 3X10 PLAST.SS</i>
	32		9161.378	SS HOPPER SPRING FOR BREW UNITSMART <i>SS HOPPER SPRING FOR BREW UNIT SMART</i>
	33	 ПІД ЗАМОВЛЕННЯ	9161.374.150	GRY BREWUNIT HOPPER BLOCKING PLATE SMART <i>GRY BREWUNIT HOPPER BLOCKING PLATE SMART</i>
	34	 ПІД ЗАМОВЛЕННЯ	11014199	BLK BREW UNIT FRONT PLATE V3 S/SCR.LAV. <i>BLK BREW UNIT FRONT PLATE V3 S/SCR.LAV.</i>
	35	 ПІД ЗАМОВЛЕННЯ	U023.011	SCREW TCEI M4,0X10 UNI 5931 SSA <i>SCREW TCEI M4,0X10 UNI 5931 SS A</i>
	36	 ПІД ЗАМОВЛЕННЯ	12000897	SCREW TCB TORX 10 3,5X20 PLAST.SS <i>SCREW TCB TORX 10 3,5X20 PLAST.SS</i>
	37		11031702	РОБОЧА ГРУПА V4 BLK SAECO ATLANTE, CRISTALLO <i>COFFEE GROUP V4 ATLANTE CAPS BLK</i>
	37	 ПІД ЗАМОВЛЕННЯ	11032374	BLACK BREW UNIT V2 CAP CA <i>BLACK BREW UNIT V2 ATLANTE CAPS CA</i>
	37	 ПІД ЗАМОВЛЕННЯ	11034353	BREW UNIT CAPS CO <i>BREW UNIT CAPS CO</i>
	39	 ПІД ЗАМОВЛЕННЯ	1040.028.050	STD TOOTHED CONNECT. F3/8X09 <i>STD TOOTHED CONNECT. F3/8X09</i>
	40	 ПІД ЗАМОВЛЕННЯ	11031829	COFF.CAPSULE FIXED CONT.V3 ATL700 ASSY. <i>COFF.CAPSULE FIXED CONT.V3 ATL700 ASSY.</i>
	40	 ПІД ЗАМОВЛЕННЯ	11034352	CAPSULE FIXED CONT. CO ASSY. <i>CAPSULE FIXED CONT. CO ASSY.</i>
	41	 ПІД ЗАМОВЛЕННЯ	11032617	SILICONE TUBE 3,5X6 L=285 MM <i>TUBO SILICONE 3.5X6 L=285 MM</i>

Model Machine

MACSAE160

CRISTALLO 400 EVO(10004761)

	42		11033574	COFFEE NOZZLES <i>COFFEE NOZZLES</i>
	43		421941306931	STAINLESS STEEL PIERCER OUTLET COFFEE CA <i>CORPO FORATORE CA USCITA CAFFE' OCS INOX</i>
	44		120340421	ELAST.SHAFT RETAIN.RING D=5 UNI7435 <i>ELAST.SHAFT RETAIN.RING D=5 UNI7435</i>
	45		149203000	LOWER COFF.CAPSULE DRILLING SUPPORT OCS <i>LOWER COFF.CAPSULE DRILLING SUPPORT OCS</i>
	46		122908721	STAINLESS STEEL PIERCER INLET WATER OCS <i>STAINLESS STEEL PIERCER INLET WATER OCS</i>
	47		11032349	ANTI-OVERTURNING PLATE <i>ANTI-OVERTURNING PLATE</i>

Model Machine

MACSAE160

CRISTALLO 400 EVO(10004761)

MACSAE160.T.0017

TAVOLA NR. 17 - ARTICOLO CRISTALLO 400 EVO(10004761)

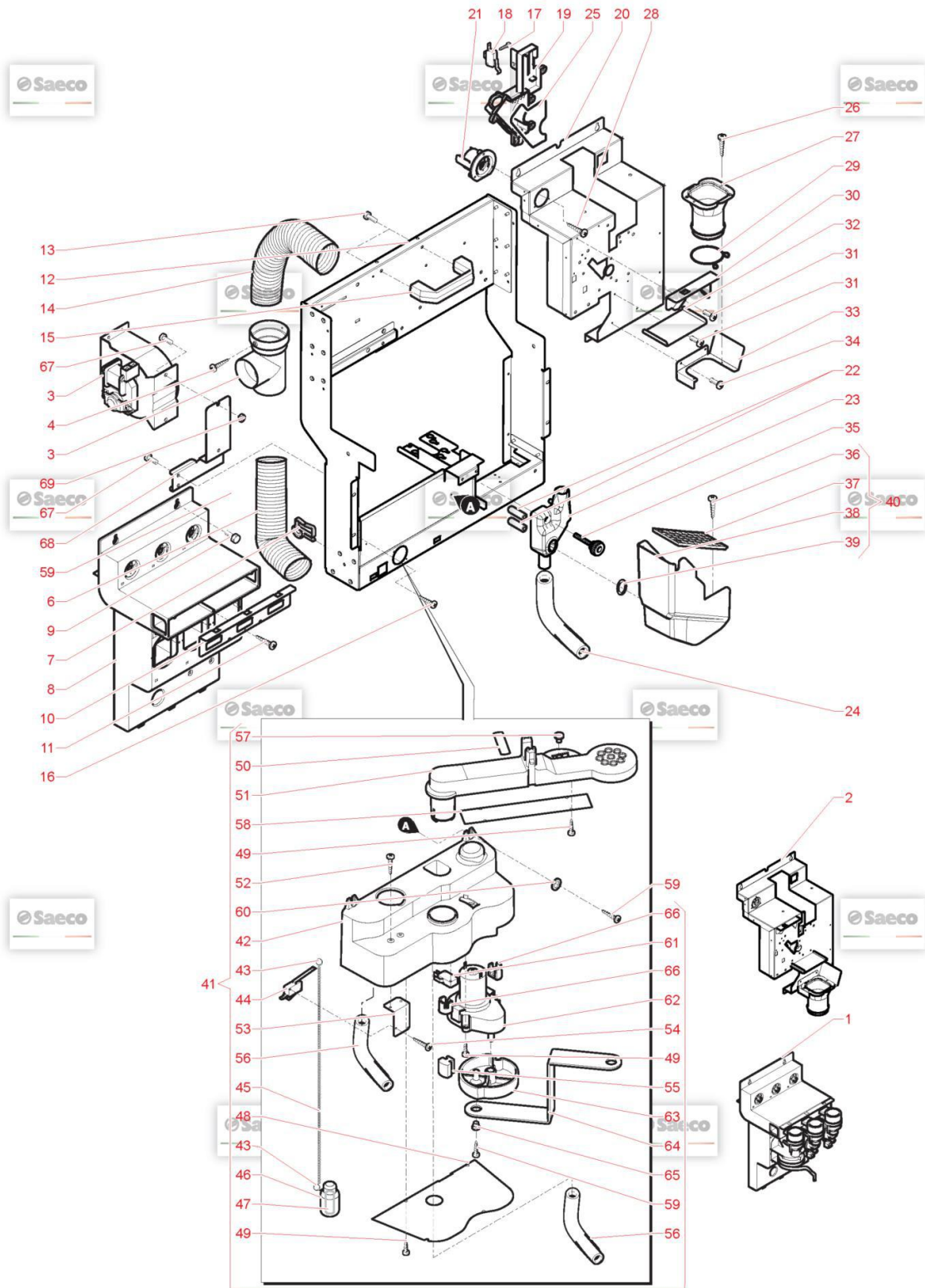

Model Machine

MACSAE160

CRISTALLO 400 EVO(10004761)

Web Pos. Foto Item - Replace by Description



Press - CTRL + CLICK go to item in a new window

Натисніть - Ctrl + права кнопка миші щоб відкрити запчастину в новому вікні



1

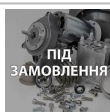

11008243

ASS. MODULE 3 MOTOR
ASS. MODULE 3 MOTOR



2

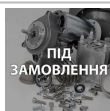

11033505

MOTOR MODULE CAPS
MOTOR MODULE CAPS



3



9121.198.00A

ВЕНТИЛЯТОР ВИТЯЖКИ 07 120X100X100 SAECO 9121.198.00A
VENTILATORE CENTRIFUGO CAP 07



4



U109.005

SCREW AUT.TCB 3,5X16 DIN 7981C
VITE AUT.TCB 3,5X16 DIN 798



5



9111.640.060

TUBE CONNECTOR
TUBE CONNECTOR



6

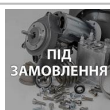

0862.145

SPIRAL TUBE L.210MM
SPIRAL TUBE L.210MM



7

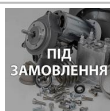

9111.718

CLIP
CLIP



8

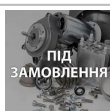

11008244

MODULE 3 MOTOR
MODULE 3 MOTOR



9

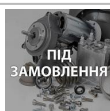

U046.001

SCREW TEFZ M5,0X16 UNI 6921 GALV.
SCREW TEFZ M5,0X16 UNI 6921 GALV.



10



11008245

ASPIRATION STEEL SHEET AT 3
ASPIRATION STEEL SHEET AT 3



11

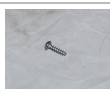

U116.003

SCREW AUT.PT TCB 3,0X12 WN 1441
VITE AUT.PT TCB 3,0X12 WN 1441 ZNP



12

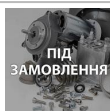

11033372

CRISTALLO400 CAPS PLATE
CRISTALLO400 CAPS PLATE



13

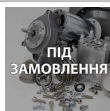











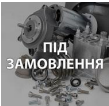

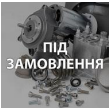













129827502

TCB SCREW M6X14 UNI 7687 ZNP
TCB SCREW M6X14 UNI 7687 ZNP

Model Machine

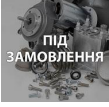
MACSAE160

























CRISTALLO 400 EVO(10004761)

	14		11010959	TUBE PVC OREGON D.32 L.170 <i>TUBE PVC OREGON D.32 L.170</i>
	15		12002150	HANDLE 37285 M.543/140 B-M6-C9 <i>HANDLE 37285 M.543/140 B-M6-C9</i>
	16		U023.009	SCREW TCEI M5,0X30 UNI 5931 8.8 B <i>SCREW TCEI M5,0X30 UNI 5931 8.8 B</i>
	17		U116.004	SCREW AUT.PT TCB 3,0X16 WN 1441 <i>SCREW AUT.PT TCB 3,0X16 WN 1441</i>
	18		NE05.050	MICROSWITCH <i>MICROSWITCH</i>
	19		11031002	CONVEYOR DUMP DISCHARGE <i>CONVEYOR DUMP DISCHARGE</i>
	20		11033506	COFFEE MODULE <i>COFFEE MODULE</i>
	21		11001574	FLANGE FIXING RATIONMOTOR LIP <i>FLANGIA FISSAGGIO MOTORIDUTTORI LIP</i>
	22		WGADM1908	SILICONE CUP <i>SILICONE CUP</i>
	23		11033769	SYPHON CRS400 EVO CAPS <i>SYPHON CRS400 EVO CAPS</i>
	24		9972.195	SILICONE TUBE 5X10 L.250MM <i>SILICONE TUBE 5X10 L.250MM</i>
	25		11031225	SPECIAL SEAL <i>SPECIAL SEAL</i>
	26		U111.008	NICK.SCREW AUT.TSP 3,5X9,5 DIN7982 C <i>NICK.SCREW AUT.TSP 3,5X9,5 DIN 7982 C</i>
	27		11031007	CONVEYOR DUMP <i>CONVEYOR DUMP</i>

Model Machine

MACSAE160

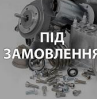









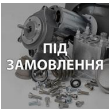







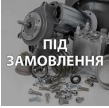

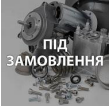





CRISTALLO 400 EVO(10004761)

	28		U116.006	SCREW AUT.PT TCB 3,5X12 WN 1441 ZNP VITE AUT.PT TCB 3,5X12 WN 1441 ZNP
	29		0862.112	GROUNDS SACK RING 8P КОЛЬЦО ANELLO SACCO FONDI 8P
	30	 ПІД ЗАМОВЛЕННЯ	11033509	CONTAINER COUPLER CONTAINER COUPLER
	31		U044.016	SCREW TSP M4,0X16 UNI 7688 GALV. VITE TSP M4, 0X16 UNI 7688 ZNP
	32	 ПІД ЗАМОВЛЕННЯ	11033496	SHEET METAL SUPPORT GROUP CAPS SHEET METAL SUPPORT GROUP CAPS
	33	 ПІД ЗАМОВЛЕННЯ	11033512	SUPPORT PLATE FOR EXHAUSTED CAPS SUPPORT PLATE FOR EXHAUSTED CAPS
	34	 ПІД ЗАМОВЛЕННЯ	U127.005	SCREW TAPT.TCB M4,0X8 DIN 7500C SCREW TAPT.TCB M4,0X8 DIN 7500C
	35	 ПІД ЗАМОВЛЕННЯ	12002032	KNOB D.18 M5X40 VOLANTINO ZIGRINATO D.18 M5X40
	36		U116.005	SCREW AUT.PT TCB 3,0X8 WN 1441 VITE AUT.PT TCB 3,0X8 WN 1441 ZNP
	37	 ПІД ЗАМОВЛЕННЯ	11032241	GRATE GRIGLIA X CONDOTTO CAPS
	38	 ПІД ЗАМОВЛЕННЯ	11032632	COFFEE CONVEY CRS EVO CONVOGLIATORE FONDI CAPS CRS EVO
	39	 ПІД ЗАМОВЛЕННЯ	11033768	SEAL SEAL
	40	 ПІД ЗАМОВЛЕННЯ	11033861	CONVEYOR EXPIRE CAPSULS CRS EVO CONVEYOR EXPIRE CAPSULS CRS EVO

Model Machine

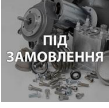
MACSAE160

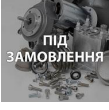



























CRISTALLO 400 EVO(10004761)

	41		11033202	NOZZLE ARM NOZZLE ARM
	42		11033186	SUPPORT NOZZLE ARM SUPPORT NOZZLE ARM
	43		9111.148	ELASTIC RING FOR FLOAT ANELLO ELASTICO X GALLEGGIANTE
	44		NE05.041	MICROSWITCH MICROINTERRUTTORE
	45		9111.775	CHAIN CHAIN
	46		9111.130	FLOAT FOR DISCHARGE LEVEL FLOAT FOR DISCHARGE LEVEL
	47		9111.147	COUNTERWEIGHT FOR FLOAT CONTRAPPESO X GALLEGGIANTE
	48		9111.722	PLATE PIASTRA SUPPORTO BRACCIO
	49		129670202	TCB PANELVIT SCREW 3,5X16 TESTA D=8 ZNP TCB PANELVIT SCREW 3,5X16 TESTA D=8 ZNP
	50		140321560	O-RING 3187 NBR OR 3187 IN NBR
	51		9111.710.A20	NOZZLE ARM BRACCIO GIREVOLE
	52		129512903	SCREW TCB PH-AB 2,9X13 UNI 6954 NI SCREW TCB PH-AB 2,9X13 UNI 6954 NI
	53		9111.719	PLATE PLATE
	54		U109.003	SCREW TCB 3,5X9,5 DIN 7981 C NICK SCREW TCB 3,5X9,5 DIN 7981 C NICK

Model Machine

MACSAE160

CRISTALLO 400 EVO(10004761)

	55		0875.150	RUBBER FOR DISPENSING COMP. <i>RUBBER FOR DISPENSING COMP.</i>
	56		11001454	PVC TUBE 16X22 L.350 MM <i>TUBO PVC 16X22 L.180MM</i>
	57		NV01.009	RUBBER BUFFER <i>GOMMINO PARACOLPI</i>
	58		9111.723	PLATE <i>PIASTRA X BRACCIO</i>
	59		U116.002	SCREW AUT.PT TCB 3,5X16 WN 1441 <i>SCREW AUT.PT TCB 3,5X16 WN 1441</i>
	60		U207.002	PLAIN WASHER 4,3X9 UNI 6592 GAL <i>ROSETTA PIANA 4,3X9 UNI 6592 ZNP</i>
	61		NE05.010	MICROSWITCH <i>MICROINTERRUPTORE</i>
	62		11033191	GEARMOTOR MECHTEX 25 RPM <i>MOTORIDUTTORE MECHTEX 25 RPM</i>
	63		9111.716.A20	CAM ARM <i>CAMMA BRACCIO</i>
	64		9111.715	CONNECTING ROD ARM <i>BIELLA BRACCIO</i>
	65		9111.204	BUSH FOR SPRING COMPENSATE STIRRER <i>BOCCOLA X MOLLA BILANCERE PALETTE</i>
	66		11033193	SPACER MOTOR ARM <i>SPACER MOTOR ARM</i>
	67		U043.015	SCREW TCBC M5,0X12 UNI 7687 GALV. <i>SCREW TCBC M5,0X12 UNI 7687 GALV.</i>
	68		11033514	SUPPORT PLATE FOR FAN CRISTALLO CAPS <i>SUPPORT PLATE FOR FAN CRISTALLO CAPS</i>

Model Machine

MACSAE160

CRISTALLO 400 EVO(10004761)



69

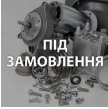

U324.003

NUT M5 FLANGED INDENTED BASE
NUT M5 FLANGED INDENTED BASE

Model Machine

MACSAE160

CRISTALLO 400 EVO(10004761)

MACSAE160.T.0018

TAVOLA NR. 18 - ARTICOLO CRISTALLO 400 EVO(10004761)

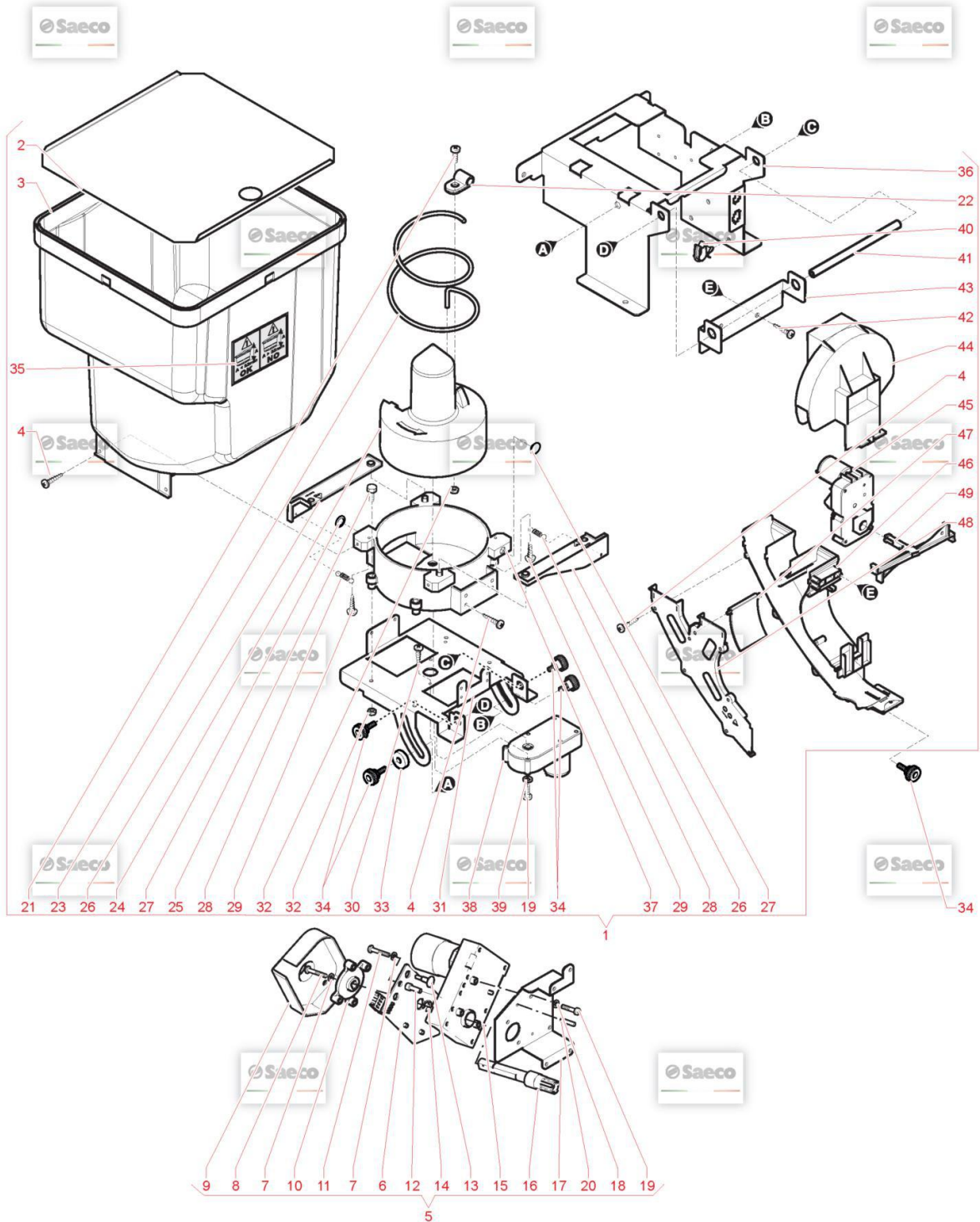

Model Machine

MACSAE160

CRISTALLO 400 EVO(10004761)

Web Pos. Foto Item - Replace by Description



Press - CTRL + CLICK go to item in a new window











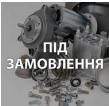

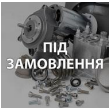













Натисніть - Ctrl + права кнопка миші щоб відкрити запчастину в новому вікні

	1		11032772	LOADER COMPLETE CAPS CL ASS.CARICATORE COMPLETO CAPS CL
	1		11033479	LOADER COMPLETE CAPS CC LOADER COMPLETE CAPS CC
	1		11034355	LOADER COMPLETE CAPS CO LOADER COMPLETE CAPS CO
	2		11032685	COVER CONTAINER COPERCHIO CONTENITORE EVO CAPS
	3		11032682	CONTAINER CONTAINER
	4		U116.006	SCREW AUT.PT TCB 3,5X12 WN 1441 ZNP VITE AUT.PT TCB 3,5X12 WN 1441 ZNP
	5		11033231	RATIOMOTOR GROUP CAPS ASS. MOTORIDUTTORE GRUPPO CAPS EVO
	6		11002134	CARD 2 SENSOR RATIOMOTOR CARD 2 SENSOR RATIOMOTOR
	7		U207.002	PLAIN WASHER 4,3X9 UNI 6592 GAL ROSETTA PIANA 4,3X9 UNI 6592 ZNP
	8		U005.010	SCREW TE M4,0X14 UNI 5739 GALV. SCREW TE M4,0X14 UNI 5739 GALV.
	9		11002211	CARD PROTECTION RATIOMOTOR CARD PROTECTION RATIOMOTOR
	10		11031224	CAM CAM
	11		U005.012	SCREW TE M4,0X30 UNI 5739 GALV. SCREW TE M4,0X30 UNI 5739 GALV.

Model Machine

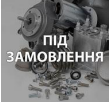
MACSAE160

















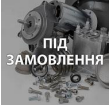





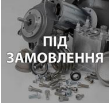

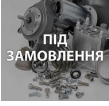
CRISTALLO 400 EVO(10004761)

	12		11002964	SPACE FOR CENTRAL CARD 2 SENSORY <i>SPACE FOR CENTRAL CARD 2 SENSORY</i>
	13		NL04.014	SPACER CARD H=9,5 <i>SPACER CARD H=9,5</i>
	14		120340804	EL. SHAFT RETAIN.RING D=8 UNI7435 <i>EL. SHAFT RETAIN.RING D=8 UNI 7435</i>
	15		12000232	LIP RATIO MOTOR ST.112B 24VDC 11RPM <i>LIP RATIO MOTOR ST.112B 24VDC 11RPM</i>
	16		11002133	JOINT WITH SHAFT FOR RATIO MOTOR <i>JOINT WITH SHAFT FOR RATIO MOTOR</i>
	17		11033219	SUPPORT PLATE MOTOR <i>SUPPORT PLATE MOTOR</i>
	18		128310404	МЕТАЛЕВЕ УБЧАСТЕ КОЛІЩАТКО UNI 8842 A4 <i>WASHER UNI 8842 A4 BURNISHED</i>
	19		129824002	TCB SCREW M4X10 UNI 7687 ZNP <i>VITE TCB M4X10 UNI 7687 ZNP</i>
	20		U407.001	ELASTIC PIN 3,0X20 UNI 6874 <i>ELASTIC PIN 3,0X20 UNI 6874</i>
	21		129825002	TCB SCREW M4X20 UNI 7687 ZNP <i>TCB SCREW M4X20 UNI 7687 ZNP</i>
	22		12001926	CABLE CLAMP SCREW FASTENING 6571 AA00 <i>CABLE CLAMP SCREW FASTENING 6571 AA00</i>
	23		11031030	SPECIAL SPRING <i>MOLLA AGITATORE CAPS</i>
	24		11032145	ROTORE CAPS <i>ROTORE CAPS</i>
	24		11032373	ROTORE CAPS CA <i>ROTORE CAPS CA</i>

Model Machine

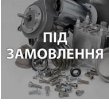
MACSAE160

CRISTALLO 400 EVO(10004761)

	24		11034281	ROTORE CAPS COVIM <i>ROTORE CAPS COVIM</i>
	25		129720102	TE SCREW M4X20 UNI 5739 ZNP <i>TE SCREW M4X20 UNI 5739 ZNP</i>
	26		11031024	SAFETY LEVER CAPS <i>LEVA SICUREZZA CAPS</i>
	27		NV01.006	ADHESIVE FOOT <i>ADHESIVE FOOT</i>
	28		9111.397	SPRING FOR TRAY /LEVER COIN RECOVER <i>MOLLA X BACINELLA/LEVA RECUP</i>
	29		U142.008	PANELVIT TSP 3,5X12 DIN 7505 AGAL <i>PANELVIT TSP 3,5X12 DIN 7505 A GAL</i>
	30		U140.017	PANELVIT TCB 3,0X20 DIN 7505 BGAL <i>PANELVIT TCB 3,0X20 DIN 7505 B GAL</i>
	31		11032699	SUPPORT EXTERNAL ROTOR <i>SUPPORT EXTERNAL ROTOR</i>
	32		U324.006	ШАЙБА M4 <i>NUT M4 FLANGED INDENTED BASE</i>
	33		11008644	LOCK PIN <i>LOCK PIN</i>
	34		12002031	KNOB D.18 M5X15 <i>KNOB D.18 M5X15</i>
	35		15004268	ADHESIVE HEIGHT CAPSULE CAFFITALY <i>ADHESIVE HEIGHT CAPSULE CAFFITALY</i>
	36		11032710	SUPPORT SHEET METAL CAPS <i>SUPPORT SHEET METAL CAPS</i>

Model Machine

MACSAE160

CRISTALLO 400 EVO(10004761)

	37		11031027	SUPPORTO ESTERNO ROTORE CAPS <i>SUPPORTO ESTERNO ROTORE CAPS</i>
	38		11031752	RATIOMOTOR 24V CAPS <i>RATIOMOTOR 24V CAPS</i>
	39		U207.004	PLAIN WASHER 4,3X16 UNI 6592 GAL <i>PLAIN WASHER 4,3X16 UNI 6592 GAL</i>
	40		NE17.013	CABLE RETAINER <i>CABLE RETAINER</i>
	41		11032533	ROTATION PIN <i>ROTATION PIN</i>
	42		U110.002	SCREW AUT.TCB 3,5X13 DIN 7981F <i>SCREW AUT.TCB 3,5X13 DIN 7981 F</i>
	43		11032534	SUPPORT CHANNEL LOADER <i>SUPPORTO CANALE CARICATORE</i>
	44		11031025	STIRRER DRAIN COVER <i>STIRRER DRAIN COVER</i>
	45		11031062	RATIOMOTOR 24V CAPS <i>RATIOMOTOR 24V CAPS</i>
	46		11031022	CHANNEL CONVEYOR CAPS <i>CHANNEL CONVEYOR CAPS</i>
	46		11032638	CHANNEL CONVEYOR CAPS CA <i>CHANNEL CONVEYOR CAPS CA</i>
	47		11031021	SWITCH CHANNEL CONVEYOR <i>SWITCH CHANNEL CONVEYOR</i>
	48		11031023	COVER CONVEYOR CAPS <i>COVER CONVEYOR CAPS</i>
	49		11031026	STIRRER DRAIN CAPS <i>STIRRER DRAIN CAPS</i>

Model Machine

MACSAE160

CRISTALLO 400 EVO(10004761)

MACSAE160.T.0019



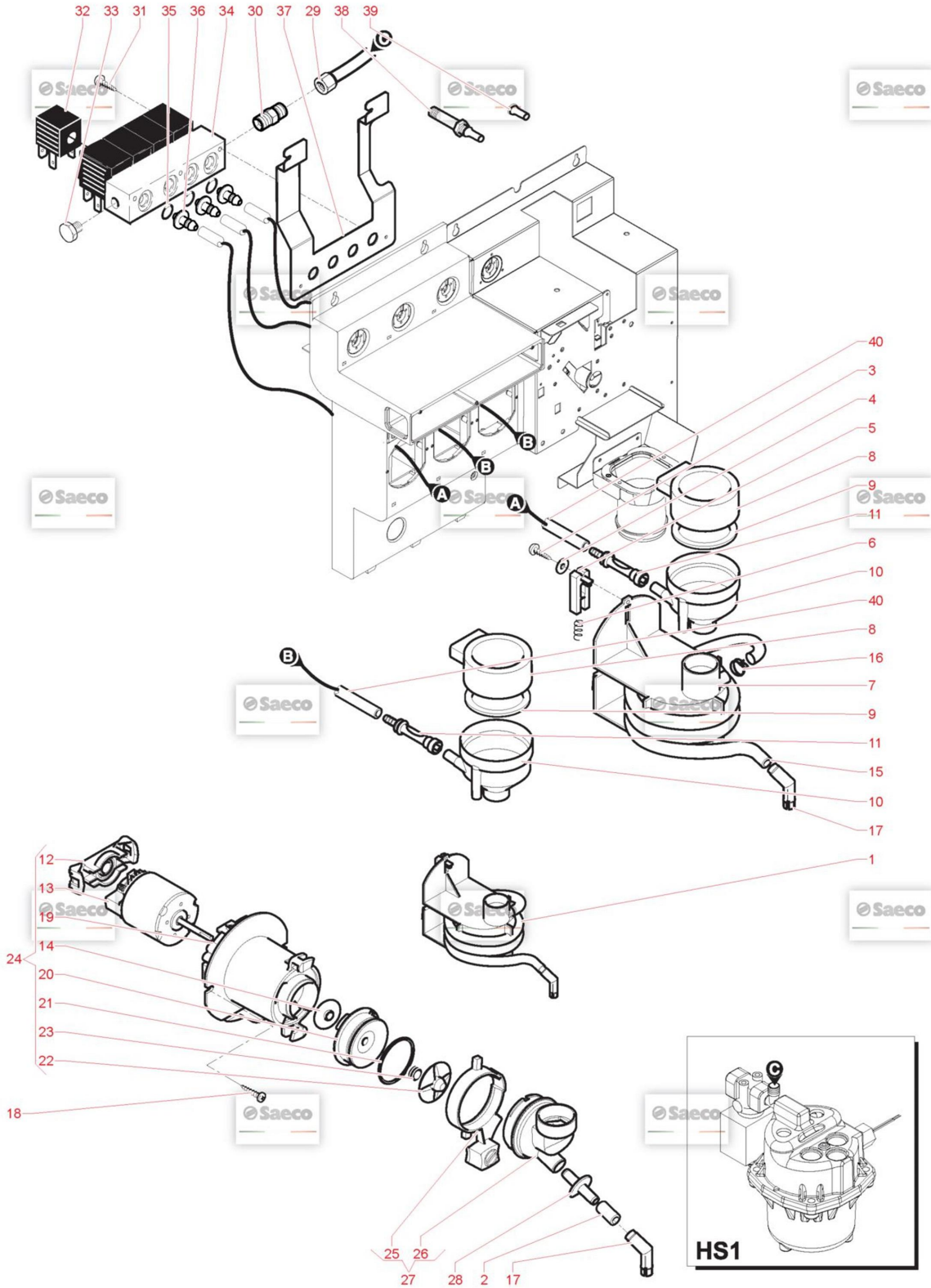























TAVOLA NR. 19 - ARTICOLO CRISTALLO 400 EVO(10004761)



Model Machine

MACSAE160





























CRISTALLO 400 EVO(10004761)

Web	Pos.	Foto	Item - Replace by	Description
				<i>Press - CTRL + CLICK go to item in a new window Натисніть - Ctrl + права кнопка миші щоб відкрити запчастину в новому вікні</i>
	1		1863.A10	ASS.MIXER FS400 ASS.MIXER A SPIRALE FS400
	2		9972.057	КОРИЧНЕВА ГУМОВА ТРУБКА 5X8 2 МЕТРИ TUBO SILICONE MARRON 5X8 L.2000 MM
	3		U116.005	SCREW AUT.PT TCB 3,0X8 WN 1441 VITE AUT.PT TCB 3,0X8 WN 1441 ZNP
	4		U207.004	PLAIN WASHER 4,3X16 UNI 6592 GAL PLAIN WASHER 4,3X16 UNI 6592 GAL
	5		9111.209.060	CURSOR FOR SPIRAL MIXER FIXING CURSOR FOR SPIRAL MIXER FIXING
	6		9111.211	SPRING FOR MIXER CURSOR MOLLA X CURSORE MISCELATORE
	7		9111.643.060	RAPID FIXING MIXER RAPID FIXING MIXER
	8		9111.010.060	LID FOR FUNNEL BROWN COPERCHIO X IMBUTO MARRON
	9		9111.011.060	SEAL FOR FUNNEL BROWN GUARNIZIONE X IMBUTO MARRON
	10		9111.009.060	FUNNEL FOR POWDERS BROWN IMBUTO X POLVERI MARRON
	11		11011394	NOZZLE ASS. ESPRESSO D.3 NOZZLE ASS. ESPRESSO D.3
	12		9111.771.270	MOTOR COUPLING ORANGE RAL MOTOR COUPLING ORANGE RAL
	13		9121.248.00P	MOTOP MIKCEPA '05 24V DC - M.B.T. COD. 912124800 SAECO 9121.248.00 MOTORE MIXER '05 24V DC - M.B.T.

Model Machine

MACSAE160

























CRISTALLO 400 EVO(10004761)

	14		9111.773.060	MOTOR PROTECTION RING <i>ANELLO PROTEZIONE MOTORE MIXER '05</i>
	15		9972.055	ТРУБКА СИЛІКОНОВА 8X12 2 МЕТРИ <i>SILICONE TUBE 8X12 L.2000MM</i>
	16		NV99.072	HOSE CLAMP D. 11.6/12.3 <i>HOSE CLAMP D. 11.6/12.3</i>
	17		9111.349	ELBOW DISPENSING NOZZLE <i>UGELLO EROGAZIONE GOMITO</i>
	18		U116.006	SCREW AUT.PT TCB 3,5X12 WN 1441 ZNP <i>VITE AUT.PT TCB 3,5X12 WN 1441 ZNP</i>
	19		9111.769.150	MIXER FLANGE <i>MIXER FLANGE</i>
	20		9111.770.060	COVER MIXER FLANGE <i>COVER MIXER FLANGE</i>
	21		NM03.012	OR ORM 0320-25 NBR <i>OR ORM 0320-25 NBR</i>
	22		9111.772.060	DISK FAN <i>VENTOLINA A DISCO MIXER '05</i>
	23		NM05.015	ПРОКЛАДКА V-RING 405 МІКСЕРА ДЛЯ КАВОМАШИН SAECO <i>V-RING MIXER '05</i>
	24		9110.160.06P	ДВИГУН МІКСЕРА ДЛЯ КАВОМАШИНИ SAECO 05 24V DC SAECO 9110.1... <i>ASS.MIXER '05 24V DC GROUP 500 SAECO</i>
	25		9111.230.270	MIXER LOCKING RING NUT ORANGERAL <i>GHIERA BLOCCAGGIO MIXER ARANCIO RAL</i>
	26		9111.227.060	MIXER CASING <i>CORPO MIXER</i>
	27		9110.027.060	MIX CASING ASS. <i>ASS.CORPO MIX SAECO CRISTALLO,ATLANTE,QUARZO,RUBINO</i>

Model Machine

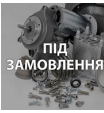
MACSAE160

CRISTALLO 400 EVO(10004761)

	28		9111.232.060	STD TUBE HOLDER SLEEVE <i>MANICOTTO PORTATUBO STANDARD</i>
	28		9111.233.060	DECAFF.TUBE HOLDER SLEEVE <i>MANICOTTO PORTATUBO DECAFFEINATO</i>
	29		11025295	TEFLON TUBE 3X6 L.170 1/8"-1/8 <i>TEFLON TUBE 3X6 L.170 1/8-1/8</i>
	30		9991.059	STRAIGHT BICONE CONNECTOR M 1/8X06 <i>STRAIGHT BICONE CONNECTOR M 1/8X06</i>
	31		129516803	SCREW TCB3,5X19 DIN 7981 NICK <i>SCREW TCB3,5X19 DIN 7981 NICK</i>
	32		20005373	SOLENOID X HS1 11023762 <i>SOLENOID X OLAB 24V DC 6000BH/BODN</i>
	33		12001169	ЛАТУННА ЗАГЛУШКА BRASS CAP 1/8 GAS CONICAL TEA <i>BRASS CAP 1/8 GAS CONICAL TEA</i>
	34		11011470	BLOCK 4 ELECTROVALVE DC OLAB TEA <i>BLOCK 4 ELECTROVALVE DC OLAB TEA</i>
	35		NM01.004	OR 2025 SILICONE <i>OR 2025 SILICONE</i>
	36		11011453	RUBBER HOLDER CONNECTOR TEA <i>RUBBER HOLDER CONNECTOR TEA</i>
	37		11033756	ELECTROVALVE SUPPORT <i>ELECTROVALVE SUPPORT</i>
	38		20005374	ASS.NUCLEO FIS+MOB.X 11009225 <i>ASS.NUCLEUS 6000BH/BODN X 11009225</i>
	39		20007305	ЧАСТИНА ЕЛЕКТРОМАГНІТНОГО КЛАПАНА З ПОДВИЖНИМ СЕРДЕЧНИК... <i>SPARE EV MOBILE CORE 11023762</i>

Model Machine

MACSAE160

CRISTALLO 400 EVO(10004761)



40

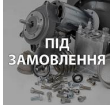

9972.246

СИЛІКОНОВА ТРУБКА 5X10 SAECO 265918 (2 МЕТРИ)

TUBO SILICONE 5X10 L.2000 MM
