

Model Machine

MACSAE114

SAECO CRISTALLO 400 ЧЁРНАЯ

MACSAE114.T.0001



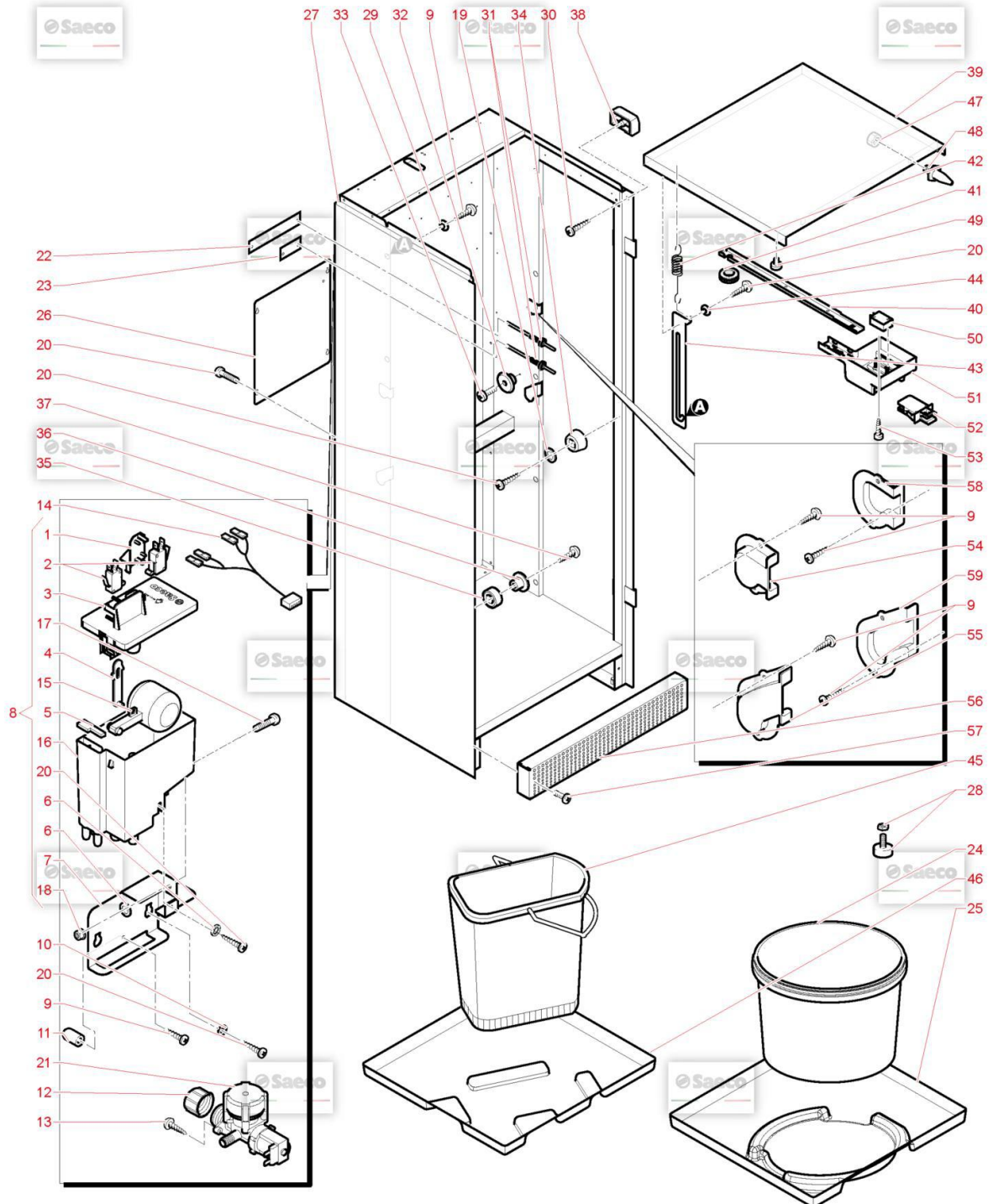





















TAVOLA NR. 1 - ARTICOLO SAECO CRISTALLO 400 ЧЁРНАЯ

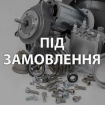

Model Machine

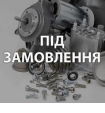
MACSAE114











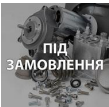

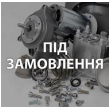

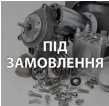











SAECO CRISTALLO 400 ЧЁРНАЯ

Web	Pos.	Foto	Item - Replace by	Description
				<i>Press - CTRL + CLICK go to item in a new window Натисніть - Ctrl + права кнопка миші щоб відкрити запчастину в новому вікні</i>
	1		9161.207.150	GREY FAUCET MICRO SUPPORT M5000 <i>SUPPORTO X MICRO RUBINETTO</i>
	2		NE05.062	MICROSWITCH + WHEEL <i>MICROINTERRUTTORE C/ROTELLA</i>
	3		9111.623	LID TANK AIR BREAK <i>COPERCHIO X SERBATOIO AIR BREAK</i>
	4		9111.621	CONNECTING ROD TANK WATER <i>CONNECTING ROD TANK WATER</i>
	5	 ПІД ЗАМОВЛЕННЯ	9111.632	RUBBER FOR AIR BREAK <i>RUBBER FOR AIR BREAK</i>
	6	 ПІД ЗАМОВЛЕННЯ	U207.009	PLAIN WASHER 5,5X15 UNI 6593 GA <i>PLAIN WASHER 5,5X15 UNI 6593 GA</i>
	7	 ПІД ЗАМОВЛЕННЯ	U324.003	NUT M5 FLANGED INDENTED BASE <i>NUT M5 FLANGED INDENTED BASE</i>
	8	 ПІД ЗАМОВЛЕННЯ	11006703	ASSEMBLY AIR BREAK CRISTALLO400 <i>ASSEMBLY AIR BREAK CRISTALLO400</i>
	9		U143.022	SCREW T.M.T. K.F.R. 3,5X9,5 ZNP <i>VITE T.M.T. K.F.R. 3,5X9,5 ZNP</i>
	10	 ПІД ЗАМОВЛЕННЯ	11011054	PIN FOR BOSS D.8 <i>PIN FOR BOSS D.8</i>
	11	 ПІД ЗАМОВЛЕННЯ	NV01.008	HOOD FOR DISPEN.COMPARTMENT SPRING <i>HOOD FOR DISPEN.COMPARTMENT SPRING</i>
	12		NV03.002	КРИШКА КЛАПАНА ПОДАЧІ ВОДИ 3/4 <i>"CAP 3/4 "KAPSTO 800R 3/4""</i>

Model Machine

MACSAE114

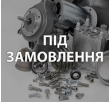











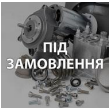













SAECO CRISTALLO 400 ЧЁРНАЯ

	13	 ПІД ЗАМОВЛЕННЯ	U110.002	SCREW AUT.TCB 3,5X13 DIN 7981F <i>SCREW AUT.TCB 3,5X13 DIN 7981 F</i>
	14	 ПІД ЗАМОВЛЕННЯ	11001279	HARNESS MICRO AIR BREAK UL <i>HARNESS MICRO AIR BREAK UL</i>
	14	 ПІД ЗАМОВЛЕННЯ	1863.642	HARNESS <i>HARNESS</i>
	15		9111.508	FLOAT FOR AIR BREAK BOWL <i>FLOAT FOR AIR BREAK BOWL</i>
	16	 ПІД ЗАМОВЛЕННЯ	9111.641	TANK AIR BREAK <i>SERBATOIO AIR BREAK C/FORO</i>
	17		U043.015	SCREW TCBC M5,0X12 UNI 7687 GALV. <i>SCREW TCBC M5,0X12 UNI 7687 GALV.</i>
	18		1863.015	AIR BREAK SUPPORT <i>AIR BREAK SUPPORT</i>
	19		U203.001	ШАЙБА 4,3X8 UNI 1749 GA <i>PLAIN WASHER 4,3X8 UNI 1749 GAL</i>
	20		U110.005	SCREW AUT.TCB 3,9X9,5 DIN 7981F <i>VITE AUT.TCB 3,9X9,5 DIN 798</i>
	21		9121.057.00P	SAFETY ELECTROVALVE 24V DC <i>SAFETY ELECTROVALVE 24V DC</i>
	22	 ПІД ЗАМОВЛЕННЯ	11000371	PANEL INSPECTION LED BOARD I/O90X20 <i>TAVOLA NR. 1 - ARTICOLO</i>
	22	 ПІД ЗАМОВЛЕННЯ	11008157	PLATE FOR PANEL INSPECTION CADRLED 90X20 <i>PLATE FOR PANEL INSPECTION CADR LED 90X20</i>
	23	 ПІД ЗАМОВЛЕННЯ	11000372	PANEL INSPECTION LED BOARD I/O35X20 <i>PANEL INSPECTION LED BOARD I/O 35X20</i>
	23	 ПІД ЗАМОВЛЕННЯ	11008185	PLATE FOR PANEL INSPECTION CADRLED 35X20 <i>PLATE FOR PANEL INSPECTION CADR LED 35X20</i>

Model Machine

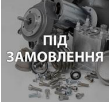
MACSAE114























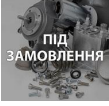

SAECO CRISTALLO 400 ЧЁРНАЯ

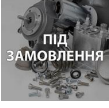
	24		12002042	BUCKET UTILPLASTIC 328X250X300BLACK <i>BUCKET UTILPLASTIC 328X250X300 BLACK</i>
	25		11032654	BOTTOM TUB <i>BOTTOM TUB</i>
	26		11001957	PANEL BACK INSPECTION <i>PANEL BACK INSPECTION</i>
	26		11005970	BACK PANEL INSPECTION NEW VERSION <i>BACK PANEL INSPECTION NEW VERSION</i>
	27		11001933	FS400 BEIGE MET. CHASSIS <i>FS400 BEIGE MET. CHASSIS</i>
	27		11014294	FS400 BLACK MET. CHASSIS <i>FS400 BLACK MET. CHASSIS</i>
	28		NV01.002	FOOT D.34 H.35 WITH NUT M10 <i>PIEDINO D.34 H.35 CON DADO M</i>
	29		1602.147	BUSH FOR DOOR CONNECTING ROD <i>BUSH FOR DOOR CONNECTING ROD</i>
	30		U109.003	SCREW TCB 3,5X9,5 DIN 7981 C NICK <i>SCREW TCB 3,5X9,5 DIN 7981 C NICK</i>
	31		NF11.102	RIVET 4,8X8 ALUMINUM/IRON BLACK <i>RIVET 4,8X8 ALUMINUM/IRON BLACK</i>
	32		9111.763	PIN <i>PIN</i>
	33		U043.014	SCREW TCBC M5,0X20 UNI 7687 GALV. <i>SCREW TCBC M5,0X20 UNI 7687 GALV.</i>
	34		NV01.013	FOOT BUFFER D.20 X H10 <i>FOOT BUFFER D.20 X H10</i>
	35		11003474	FS400 DOOR WHEEL <i>FS400 DOOR WHEEL</i>

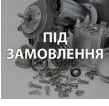
Model Machine

MACSAE114













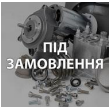













SAECO CRISTALLO 400 ЧЁРНАЯ

	36		11006477	FS400 DOOR PIVOT FOR WHEEL <i>FS400 DOOR PIVOT FOR WHEEL</i>
	37		12000780	SCREW TSPC M4,0X20 UNI 7688 GALV. <i>SCREW TSPC M4,0X20 UNI 7688 GALV.</i>
	38		11000387	WEDGE FOR CHASSIS COVER <i>WEDGE FOR CHASSIS COVER</i>
	39		11001934	FS400 UPPER COVER MET. BEIGE <i>FS400 UPPER COVER MET. BEIGE</i>
	39		11014292	FS400 UPPER COVER MET. BLACK <i>FS400 UPPER COVER MET. BLACK</i>
	40		1863.034	CHANNEL FOR DOOR CABLES <i>CHANNEL FOR DOOR CABLES</i>
	41		NE16.002	GROMMET D.11X20,5XH.7 <i>GROMMET D.11X20,5XH.7</i>
	42		11008175	SPRING FOR UPPER DOOR CRISTALLO400 <i>SPRING FOR UPPER DOOR CRISTALLO400</i>
	43		1863.038	STIRRER UPPER DOOR <i>STIRRER UPPER DOOR</i>
	44		0875.113	BUSH FOR SLIDING PLATE <i>BUSH FOR SLIDING PLATE</i>
	45		12000031	BUCKET UTILPLASTIC 18262 KOUROS 1 BLACK <i>SECCHIO UTILPLASTIC 18262 KOUROS 1 ROSSO</i>
	46		11000551	BOTTOM TUB <i>VASCA DI FONDO</i>
	47		U324.004	NUT M6 FLANGED INDENTED BASE <i>DADO M6 FLANGIATO BASE DENTELLATA</i>

Model Machine

MACSAE114

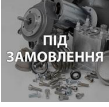

























SAECO CRISTALLO 400 ЧЁРНАЯ

	48		1863.071	PIN FOR CASING COVER <i>PERNO X COPERTURA CARCASSA</i>
	49		NV01.016	FOOT D.12 X H2,5 <i>FOOT D.12 X H2,5</i>
	50		NE05.054	MICROSWITCH CROUZET F83161.9 <i>MICROINTERRUTTORE CROUZET F83161.9</i>
	51		1863.035.A20	SUPPORT FOR MICRO DOOR <i>SUPPORTO MICRO PORTA</i>
	52		NE05.039	BIPOLAR MICROSWITCH <i>MICROINTERRUTTORE BIPOLARE</i>
	52		NE05.061	MICROSWITCH CHERRY D413 .V3LD <i>MICROINT.BIPOLARE XTD 22AZ1</i>
	53		U116.006	SCREW AUT.PT TCB 3,5X12 WN 1441 ZNP <i>VITE AUT.PT TCB 3,5X12 WN 1441 ZNP</i>
	54		1863.016.A20	UPPER GUIDE LEFT PLATE <i>UPPER GUIDE LEFT PLATE</i>
	55		1863.017.A20	LOWER GUIDE LEFT PLATE <i>LOWER GUIDE LEFT PLATE</i>
	56		11001935	FS400 LOWER PANEL MET.BEIGE <i>GRIGLIA INFERIORE FS400 BEIGE MET.</i>
	56		11014232	BASE CRISTALLO400-600 BLACK <i>BASE CRISTALLO400-600 BLACK</i>
	57		12002052	ZN-B TCB SCREW M4X16 <i>ZN-B TCB SCREW M4X16</i>
	58		1863.018.A20	UPPER GUIDE RIGHT PLATE <i>UPPER GUIDE RIGHT PLATE</i>
	59		1863.019.A20	LOWER GUIDE RIGHT PLATE <i>LOWER GUIDE RIGHT PLATE</i>

Model Machine

MACSAE114

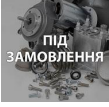











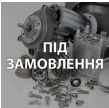













SAECO CRISTALLO 400 ЧЁРНАЯ

Web	Pos.	Foto	Item - Replace by	Description
				<i>Press - CTRL + CLICK go to item in a new window Натисніть - Ctrl + права кнопка миші щоб відкрити запчастину в новому вікні</i>
	1		9111.720.050	UNLOADING COLLECTOR COLLETTORE SCARICHI
	2		U315.001	NUT SQUARE M4 UNI 5596 GALV. NUT SQUARE M4 UNI 5596 GALV.
	3		U207.002	PLAIN WASHER 4,3X9 UNI 6592 GAL ROSETTA PIANA 4,3X9 UNI 6592 ZNP
	4		129825002	TCB SCREW M4X20 UNI 7687 ZNP TCB SCREW M4X20 UNI 7687 ZNP
	5		11003905	ВЕНТИЛЯТОР 120 VL CENTRIFUGAL FAN 120V UL
	5		9121.198.00A	ВЕНТИЛЯТОР ВИТЯЖКИ 07 120X100X100 SAECO 9121.198.00A VENTILATORE CENTRIFUGO CAP 07
	6		U110.003	SCREW AUT.TCB 3,5X9,5 DIN 7981F VITE AUT.TCB 3,5X9,5 DIN 798
	7		9111.708.A20	MAIN PLATE PIASTRA PRINCIPALE
	8		9111.766	CONNECTING PLATE CONNECTING PLATE
	9		1883.004	SHEATH SHEATH
	10		NE05.018	MICROSWITCH MICROINTERRUTTORE SAECO XCG5-81-P5
	11		0862.014	ASPIRATOR TUBE L=290 ASPIRATOR TUBE L=290
	12		9111.640.060	TUBE CONNECTOR TUBE CONNECTOR

Model Machine

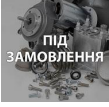
MACSAE114

SAECO CRISTALLO 400 ЧЁРНАЯ

	13		129670202	TCB PANELVIT SCREW 3,5X16 TESTA D=8 ZNP <i>TCB PANELVIT SCREW 3,5X16 TESTA D=8 ZNP</i>
	14		9111.732.A20	SUPPORT <i>SUPPORT</i>
	15		0862.145	SPIRAL TUBE L.210MM <i>SPIRAL TUBE L.210MM</i>
	16		9111.718	CLIP <i>CLIP</i>
	17		9110.139	COFFEE CONT. ASS. <i>ASS.CONTENTITORE CAFFE'</i>
	18		9111.728	COVER FOR COFFEE CONTAINER <i>COPERCHIO CONTENITORE CAFFE'</i>
	19		9111.724	CONTAINER FOR COFFEE BEAN <i>CONTENITORE CAFFE' IN GRANI</i>
	20		11000793	MIXER ASPIRATION PLATE <i>MIXER ASPIRATION PLATE</i>
	21		U023.009	SCREW TCEI M5,0X30 UNI 5931 8.8 B <i>SCREW TCEI M5,0X30 UNI 5931 8.8 B</i>
	22		11010736	ASS.GUILLOTINE COFFEE (1813.027) <i>ASS.GUILLOTINE COFFEE</i>
	23		9111.711	INOX. PLATE <i>INOX. PLATE</i>
	24		9111.717.270	KNOB FIXING PLATE <i>KNOB FIXING PLATE</i>
	25		U207.001	PLAIN WASHER 5,3X10 UNI 6592 GAL <i>ROSETTA PIANA 5,3X10 UNI 6</i>
	26		9111.481.060	COLUMN CAP <i>COLUMN CAP</i>

Model Machine

MACSAE114











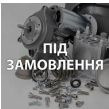









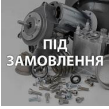

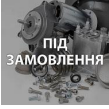



SAECO CRISTALLO 400 ЧЁРНАЯ

	27		11002131	CARTER FOR MIXER TANK <i>CARTER X VASCA MIXER</i>
	28		9111.712	INOX. PLATE FOR MIXERS <i>INOX. PLATE FOR MIXERS</i>
	29		0862.112	GROUNDS SACK RING 8P <i>КОЛЬЦО ANELLO SACCO FONDI 8P</i>
	30		0862.111.050	GROUNDS DUCT <i>CONDOTTO X FONDI</i>
	31		9111.714.A20	TANK <i>TANK</i>
	32		11028763	ETL ASSEMBLED NOZZLES ARM <i>ETL ASSEMBLED NOZZLES ARM</i>
	32		11033202	NOZZLE ARM <i>NOZZLE ARM</i>
	32		9110.148	NOZZLE ARM <i>NOZZLE ARM</i>
	33		11033186	SUPPORT NOZZLE ARM <i>SUPPORT NOZZLE ARM</i>
	33		9111.709.A20	SUPPORT NOZZLE ARM <i>SUPPORT NOZZLE ARM</i>
	34		9111.148	ELASTIC RING FOR FLOAT <i>ANELLO ELASTICO X GALLEGGIANTE</i>
	35		NE05.041	MICROSWITCH <i>MICROINTERRUTTORE</i>
	36		9111.775	CHAIN <i>CHAIN</i>

Model Machine

MACSAE114

















SAECO CRISTALLO 400 ЧЁРНАЯ

	37		9111.130	FLOAT FOR DISCHARGE LEVEL <i>FLOAT FOR DISCHARGE LEVEL</i>
	38		9111.147	COUNTERWEIGHT FOR FLOAT <i>CONTRAPPESO X GALLEGGIANTE</i>
	39		9111.722	PLATE <i>PIASTRA SUPPORTO BRACCIO</i>
	40		140321560	O-RING 3187 NBR <i>OR 3187 IN NBR</i>
	41		9111.710.A20	NOZZLE ARM <i>BRACCIO GIREVOLE</i>
	42		129512903	SCREW TCB PH-AB 2,9X13 UNI 6954 NI <i>SCREW TCB PH-AB 2,9X13 UNI 6954 NI</i>
	43		9111.719	PLATE <i>PLATE</i>
	44		U109.003	SCREW TCB 3,5X9,5 DIN 7981 C NICK <i>SCREW TCB 3,5X9,5 DIN 7981 C NICK</i>
	45		0875.150	RUBBER FOR DISPENSING COMP. <i>RUBBER FOR DISPENSING COMP.</i>
	46		11001454	PVC TUBE 16X22 L.350 MM <i>TUBO PVC 16X22 L.180MM</i>
	47		NV01.009	RUBBER BUFFER <i>GOMMINO PARACOLPI</i>
	48		9111.723	PLATE <i>PIASTRA X BRACCIO</i>
	49		U116.002	SCREW AUT.PT TCB 3,5X16 WN 1441 <i>SCREW AUT.PT TCB 3,5X16 WN 1441</i>
	50		NE05.010	MICROSWITCH <i>MICROINTERRUTTORE</i>

Model Machine

MACSAE114

SAECO CRISTALLO 400 ЧЁРНАЯ

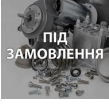
	51		11025284	MOTORIDUTTORE FIBER 37RPM <i>MOTORIDUTTORE FIBER 37RPM</i>
	51		11033191	GEARMOTOR MECHTEX 25 RPM <i>MOTORIDUTTORE MECHTEX 25 RPM</i>
	51		9121.107.00P	STIRRER RATIOMOTOR FIBER <i>MOTORIDUTTORE PALETTE FIBER</i>
	52		9111.716.A20	CAM ARM <i>CAMMA BRACCIO</i>
	53		9111.715	CONNECTING ROD ARM <i>BIELLA BRACCIO</i>
	54		9111.204	BUSH FOR SPRING COMPENSATE STIRRER <i>BOCCOLA X MOLLA BILANCERE PALETTE</i>
	55		U109.005	SCREW AUT.TCB 3,5X16 DIN 7981C <i>VITE AUT.TCB 3,5X16 DIN 798</i>
	56		11030483	SYPHON <i>SIFONE FORATO</i>
	57		11033193	SPACER MOTOR ARM <i>SPACER MOTOR ARM</i>

Model Machine

MACSAE114

SAECO CRISTALLO 400 ЧЁРНАЯ

MACSAE114.T.0003

TAVOLA NR. 3 - ARTICOLO SAECO CRISTALLO 400 ЧЁРНАЯ

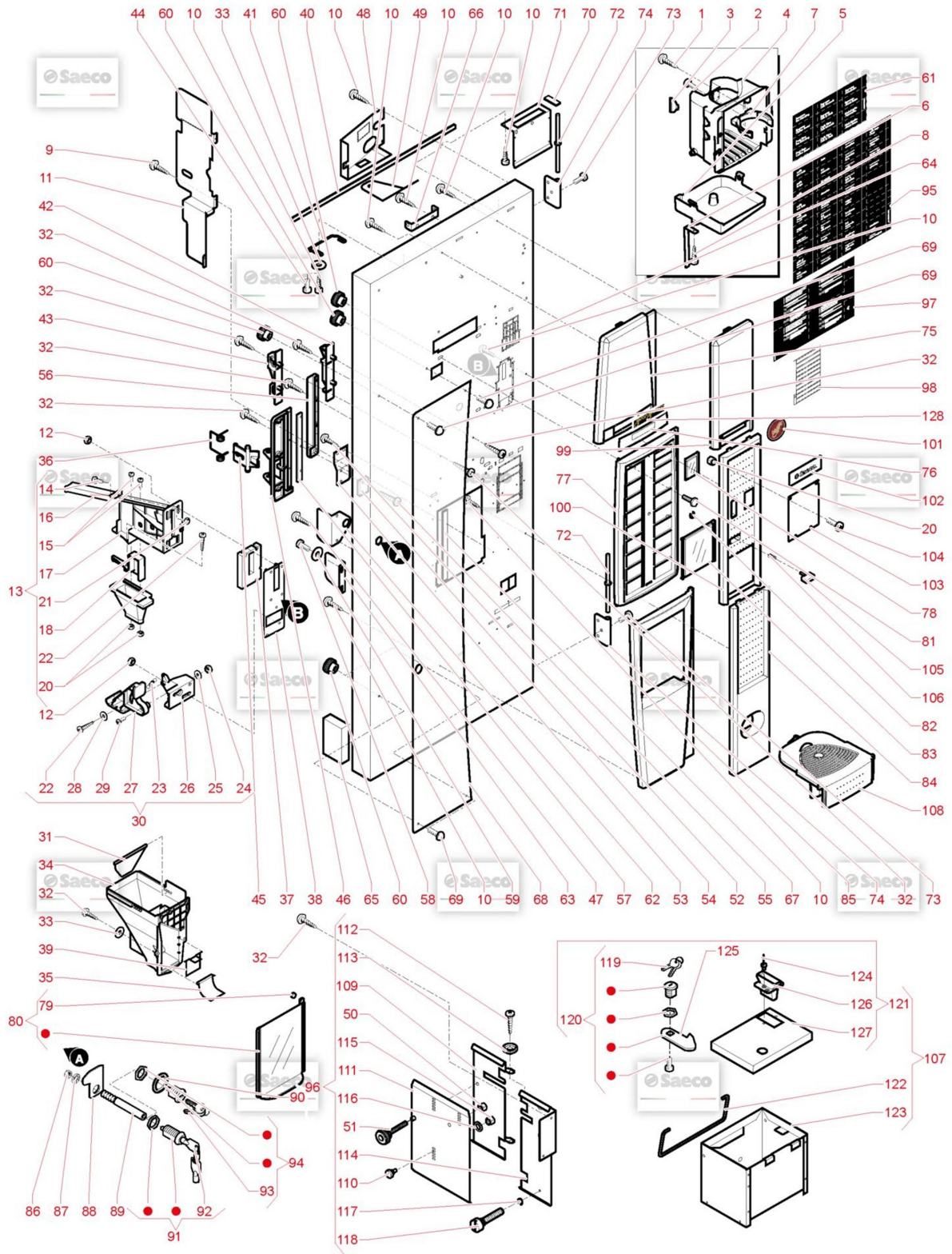

Model Machine

MACSAE114

SAECO CRISTALLO 400 ЧЁРНАЯ

Web Pos. Foto Item - Replace by Description



Press - CTRL + CLICK go to item in a new window

Натисніть - Ctrl + права кнопка миші щоб відкрити запчастину в новому вікні



1



U109.022

SCREW AUT.TCB 4,2X13 DIN 7981C
SCREW AUT.TCB 4,2X13 DIN 7981 C



2



U019.005

STEI SCREW M5,0X10 UNI 5923 GALV.
VITE STEI M5,0X10 UNI 5923 Z



3



1863.013

LENS FOR COMPARTMENT DISPENSER
LENTE X VANO EROGAZIONE



4

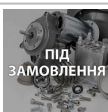

1863.012.050

COMPARTMENT DISPENSER
VANO EROGAZIONE



5



1863.023.050

WATER DRIP TRAY
VASCA X VANO EROGAZIONE



6



1863.024

STIRRUP FOR COMPARTMENT DISPENSER
STAFFA X VANO EROGATORE



7



9111.368.050

VARIABLE CUP SUPPORT BLACK
SUPPORTO BICCHIERE VARIABILE



8



U109.023

SCREW AUT.TCB 4,2X9,5 DIN 7981C
SCREW AUT.TCB 4,2X9,5 DIN 7981 C



9



U110.004

SCREW AUT.TCB 3,5X6,5 DIN 7981F
VITE AUT.TCB 3,5X6,5 DIN 7981 F NIK



10



U110.003

SCREW AUT.TCB 3,5X9,5 DIN 7981F
VITE AUT.TCB 3,5X9,5 DIN 798



11



11002386

PROTECTION COVER PAYMENT SYSTEM
PROTECTION COVER PAYMENT SYSTEM



12



U324.003

NUT M5 FLANGED INDENTED BASE
NUT M5 FLANGED INDENTED BASE



13

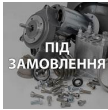





























11011614

ASS.SCIVOLO MONETE CRISTALLO400
ASS.SCIVOLO MONETE CRISTALLO400

Model Machine

MACSAE114

























SAECO CRISTALLO 400 ЧЁРНАЯ

	14		U043.007	SCREW TCBC M3,0X8 UNI 7687 GALV. <i>SCREW TCBC M3,0X8 UNI 7687 GALV.</i>
	15		12002039	SCREW TCBD TORX 20 M4X12 ZN-B <i>VITE TCBD TORX 20 M4X12 ZN-B</i>
	16		11011663	SLIDE COVER COIN <i>SLIDE COVER COIN</i>
	17		11011616	COIN CHUTE <i>COIN CHUTE</i>
	18	 ПІД ЗАМОВЛЕННЯ	11011618	БЛОК ДЛЯ КОНВЕЄРА МОНЕТ <i>BLOCCO X CONVOGLIATORE MONETE REGOLABILE</i>
	19		11012131	COIN CONVEYOR ADJUSTABLE FS400/600 <i>COIN CONVEYOR ADJUSTABLE FS400/600</i>
	20		U302.003	МЕТАЛЕВА ГАЙКА М4 UNI 5588 ZNP <i>DADO ESAGONALE M4 UNI 5588 ZNP</i>
	21		U302.002	NUT HEXAGONAL M3 UNI 5588 <i>NUT HEXAGONAL M3 UNI 5588</i>
	22		U116.005	SCREW AUT.PT TCB 3,0X8 WN 1441 <i>VITE AUT.PT TCB 3,0X8 WN 1441 ZNP</i>
	23		9111.397	SPRING FOR TRAY /LEVER COIN RECOVER <i>MOLLA X BACINELLA/LEVA RECUP</i>
	24		123453102	GALV.SELF LOCK NUT HIGH M4 DIN982 <i>GALV.SELF LOCK NUT HIGH M4 DIN 982</i>
	25	 ПІД ЗАМОВЛЕННЯ	U201.005	PLAIN WASHER 4,3X12 DIN 7349 GAL <i>PLAIN WASHER 4,3X12 DIN 7349 GAL</i>
	26		11011619	SUPPORT LEVER COIN RECOVERY <i>SUPPORT LEVER COIN RECOVERY</i>
	27		11011660	LEVER COIN RECOVERY <i>LEVER COIN RECOVERY</i>

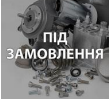
Model Machine

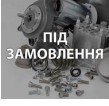
MACSAE114













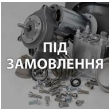



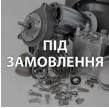





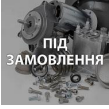



SAECO CRISTALLO 400 ЧЕРНАЯ

	28		U212.006	WASHER 3,2X11X0,5 ZNP WASHER 3,2X11X0,5 ZNP
	29		129825002	TCB SCREW M4X20 UNI 7687 ZNP TCB SCREW M4X20 UNI 7687 ZNP
	30		11011615	LEVER ASS. COIN RECOVERY LEVER ASS. COIN RECOVERY
	31		11011662	ADJUSTABLE PLATE ADJUSTABLE PLATE
	32		U110.002	SCREW AUT.TCB 3,5X13 DIN 7981F SCREW AUT.TCB 3,5X13 DIN 7981 F
	33		U207.002	PLAIN WASHER 4,3X9 UNI 6592 GAL ROSETTA PIANA 4,3X9 UNI 6592 ZNP
	34		11011661	DUCT COIN RECOVERY DUCT COIN RECOVERY
	35		9111.357.050	COIN CHUTE BOTTOM BLACK FONDO CONDOTTO MONETE NERO
	36		9111.373	SPRING FOR DISP. COMP. RETAINING MOLLA X FERMO VANO EROGAZ.
	37		11029543	SPACER SPACER
	38		11012569	ASS.PIASTRA MONT.CANALE MONETEF400/600 ASS.PIASTRA MONT.CANALE MONETE FS400/600
	38		11021706	BLANK PROTECTION COIN CHANNELRU/UA BLANK PROTECTION COIN CHANNEL RU/UA
	39		11001739	COIN CHUTE DOOR RED PORTELLO CONDOTTO MONETE ROSSO

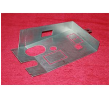
Model Machine

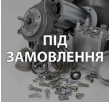
MACSAE114













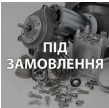













SAECO CRISTALLO 400 ЧЁРНАЯ

	39		11006845	DOOR CONDUCTING COINS GREY <i>DOOR CONDUCTING COINS GREY</i>
	40		1863.073	DOOR SEAL FS400 <i>DOOR SEAL FS400</i>
	41		11002095	SPRING FOR CHASSIS COVER'S SWITCH <i>MOLLA X MICRO COPERCHIO CARCASSA</i>
	41		11007640	SPRING FOR UPPER DOOR MICROSWITCH <i>SPRING FOR UPPER DOOR MICROSWITCH</i>
	42		1863.033.A20	CUP DISTR. SUPPORT <i>SUPPORTO DISTRIBUTORE BICCH.DX</i>
	43		1863.032.A20	CUP DISTR. SUPPORT <i>SUPPORTO DISTRIBUTORE BICCH.SX</i>
	44		U043.006	SCREW TCBC M4,0X14 UNI 7687 GALV. <i>SCREW TCBC M4,0X14 UNI 7687 GALV.</i>
	45		9111.372.050	DISP. COMPARTM. LOCKING LEVER <i>LEVA FERMO VANO EROGAZIONE NERO</i>
	46		9111.371.050	RIGHT SUPPORT DISP. COMP. BLACK <i>SUPPORTO DX VANO EROGAZ.NERO</i>
	47		U109.003	SCREW TCB 3,5X9,5 DIN 7981 C NICK <i>SCREW TCB 3,5X9,5 DIN 7981 C NICK</i>
	48		11030363	CPU CARTER BLK <i>CPU CARTER BLK</i>
	49		1863.079	BASKET STOP PLATE <i>BASKET STOP PLATE</i>
	50		U302.001	NUT HEXAGONAL M5 UNI 5588 <i>DADO ESAGONALE M5 UNI 5</i>
	51		12002033	KNOB D.18 M5X25 <i>KNOB D.18 M5X25</i>

Model Machine

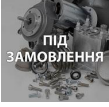
MACSAE114

















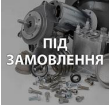





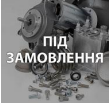

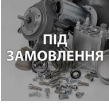
SAECO CRISTALLO 400 ЧЁРНАЯ

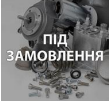
	52		129512503	SCREW TCB 2,9X9,5 DIN 7981 NICK SCREW TCB 2,9X9,5 DIN 7981 NICK
	53	 ПІД ЗАМОВЛЕННЯ	1863.077	BRACKET SUPPORT REED BRACKET SUPPORT REED
	54	 ПІД ЗАМОВЛЕННЯ	1863.649	REED FOR DOOR REED FOR DOOR
	55	 ПІД ЗАМОВЛЕННЯ	U110.011	SCREW AUT.TCB 2,9X9,5 DIN 7981F SCREW AUT.TCB 2,9X9,5 DIN 7981 F
	56		1863.058	LEFT SUPPORT DISP.COMP. BLACK SUPPORTO SX VANO EROGAZIONE
	57		9111.774	SPACER FOR SUPPORT DISTANZIALE X SUPPORTO VANO BICCH.
	58		U043.015	SCREW TCBC M5,0X12 UNI 7687 GALV. SCREW TCBC M5,0X12 UNI 7687 GALV.
	59		U207.001	PLAIN WASHER 5,3X10 UNI 6592 GAL ROSETTA PIANA 5,3X10 UNI 6
	60		12002034	KNOB WITH BUSH M5 KNOB WITH BUSH M5
	61	 ПІД ЗАМОВЛЕННЯ	15001893	PRODUCTS LABEL'S SHEET CRISTALLO600TTT PRODUCTS LABEL'S SHEET CRISTALLO600TTT
	61	 ПІД ЗАМОВЛЕННЯ	15002022	PRODUCTS LABEL'S SHEET CRISTALLO600TTT PRODUCTS LABEL'S SHEET CRISTALLO600TTT
	61	 ПІД ЗАМОВЛЕННЯ	15004044	INSTRUCTION LABEL CRISTALLO600TTT CB BLK INSTRUCTION LABEL CRISTALLO600TTT CB BLK
	62	 ПІД ЗАМОВЛЕННЯ	1863.059	BRACKET FOR LOCK BRACKET FOR LOCK
	63	 ПІД ЗАМОВЛЕННЯ	11003448	MOVABLE PLATE FOR FS400 DOOR MOVABLE PLATE FOR FS400 DOOR

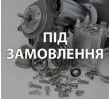
Model Machine

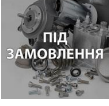
MACSAE114

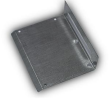













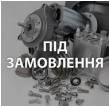











SAECO CRISTALLO 400 ЧЁРНАЯ

	64		11004683	ASS. DOOR SHEET METAL FS400 <i>ASS. DOOR SHEET METAL FS400</i>
	64		11006292	DOOR ASSEMBLY CRISTALLO400 RU/UA <i>DOOR ASSEMBLY CRISTALLO400 RU/UA</i>
	64		11014168	ASS. DOOR SHEET METAL CRISTALLO400 <i>ASS. DOOR SHEET METAL CRISTALLO400</i>
	64		11014230	DOOR CRISTALLO400 FILM PVC GRYRU/UA <i>DOOR CRISTALLO400 FILM PVC GRYRU/UA</i>
	65		11000390	OUTDISTANCE FOR FS400 DOOR <i>OUTDISTANCE FOR FS400 DOOR</i>
	66		0894.185	BASKET STOP BRACKET <i>BASKET STOP BRACKET</i>
	67		11000399	PROFILE GES26F-A-C0 L=148 MM <i>PROFILE GES26F-A-C0 L=148 MM</i>
	68		11014279	CRISTALLO400/600 DIA <i>CRISTALLO400/600 DIA</i>
	68		11030994	CRISTALLO600 C.B. DIA <i>CRISTALLO600 C.B. DIA</i>
	69		12001436	SCREW FOR BLACK SLIDE <i>SCREW FOR BLACK SLIDE</i>
	70		11003787	PROFILE GES62F-A-C0 L=20 MM <i>PROFILE GES62F-A-C0 L=20 MM</i>
	71		1863.025	SUPPORT PLATE CPU <i>PIASTRA SUPPORTO CPU</i>
	72		1863.043	HINGE <i>HINGE</i>

Model Machine

MACSAE114





























SAECO CRISTALLO 400 ЧЁРНАЯ

	73		U044.013	SCREW TSPC M4,0X12 UNI 7688 GALV. VITE TSPC M4,0X12 UNI 7688 ZNP
	74		11001936	FS400 MET.BEIGE HINGE FS400 MET.BEIGE HINGE
	74		11014249	FS400 BLK HINGE FS400 BLK HINGE
	75		11003414	RED PEARLY DISPLAY PANEL PANNELLO DISPLAY ROSSO PERLATO
	75		11014269	FS400 DISPLAY PANEL BLACK FS400 DISPLAY PANEL BLACK
	76		1863.074	DISPLAY GLASS VETRINO DISPLAY
	77		11003413	RED PEARLY KEYBOARD PANEL PANNELLO TASTIERA ROSSO PERLATO
	77		11014291	FS400 KEYBOARD PANEL FS400 KEYBOARD PANEL
	78		1863.065	ASS.COIN BOX VETRINO INTRODUZIONE MONETE
	79		9991.093	MAGNET D=9,5 X H=1,5 MAGNETE D.9,5 X 1,5
	80		11032646	ШТОКРА СЛОТА ВИДАЧІ НАПОЮ SAECO CUP STATION S DOOR
	81		U005.015	SCREW TE M5,0X30 UNI 5739 GALV. SCREW TE M5,0X30 UNI 5739 GALV.
	82		U701.003	SNAP RING 7 UNI 7434 ANELLO ELASTICO 7 UNI 7434
	83		1863.061	ASS.COVER BOX VETRINO ISTRUZIONI

Model Machine

MACSAE114

















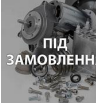

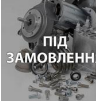

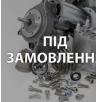

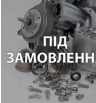

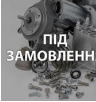
SAECO CRISTALLO 400 ЧЁРНАЯ

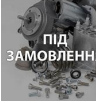
	84		11003415	RED PEARLY PANEL RECOVERY REST <i>PANELLO RECUPERO RESTO ROSSO PERLATO</i>
	84		11014270	BLACK PANEL RECOVERY REST <i>BLACK PANEL RECOVERY REST</i>
	85		11003412	RED PEARLY VAIN DISBURSEMENT PANEL <i>PANNELLO VANO EROGATORE ROSSO PERLATO</i>
	85		11014290	FS400 DISBURSEMENT PANEL VAIN <i>FS400 DISBURSEMENT PANEL VAIN</i>
	86		U302.006	NUT HEXAGONAL M10 UNI 5588 <i>DADO ESAGONALE M10 UNI 5</i>
	87		U208.008	TOOTHED WASHER 10,5X18 UNI 3703 G <i>ROSETTA DENT. 10,5X18 UNI 3</i>
	88		11003519	PLATE FOR LOCK COMBI <i>PIASTRINA X SERRATURA COMBI</i>
	88		1863.057	LOCK LEVER <i>LOCK LEVER</i>
	89		0875.338	LOCK FOR PIN M10 <i>PERNO M10 X SERRATURA FUORI PRODUZIONE</i>
	89		11003515	PIN FOR LOCK M6 COMBI <i>PERNO X SERRATURA M6 COMBI</i>
	89		11021368	PIN FOR LOCK M6 CRISTALLO400/600 <i>PIN FOR LOCK M6 CRISTALLO400/600</i>
	90		11014166	LOCK BUSH <i>LOCK BUSH</i>
	91		NV02.052	TUBULAR LOCK L.31 <i>SERRATURA TUBOLARE L.31</i>
	92		1482.R02	***KEY FOR DOOR MB DA 8P <i>KEY FOR DOOR MB DA 8P</i>

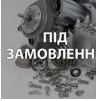
Model Machine

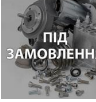
MACSAE114

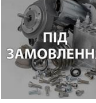









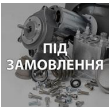

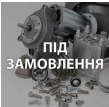

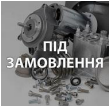











SAECO CRISTALLO 400 ЧЁРНАЯ

	93		NV02.243	KEY RIELDA AJ306A <i>KEY RIELDA AJ306A</i>
	94		NV02.229	LOCK RIELDA MOD.512 + KEY <i>LOCK RIELDA MOD.512 + KEY</i>
	95		15000246	PRODUCTS LABEL'S SHEET FS400 F <i>PRODUCTS LABEL'S SHEET FS400 F</i>
	95		15000247	PRODUCTS LABEL'S SHEET FS400 I <i>PRODUCTS LABEL'S SHEET FS400 I</i>
	95		15000248	PRODUCTS LABEL'S SHEET FS400 D <i>PRODUCTS LABEL'S SHEET FS400 D</i>
	95		15000249	PRODUCTS LABEL'S SHEET FS400 P <i>PRODUCTS LABEL'S SHEET FS400 P</i>
	95		15000250	PRODUCTS LABEL'S SHEET FS400 E <i>PRODUCTS LABEL'S SHEET FS400 E</i>
	95		15000251	PRODUCTS LABEL'S SHEET FS400 CH <i>PRODUCTS LABEL'S SHEET FS400 CH</i>
	95		15000252	PRODUCTS LABEL'S SHEET FS400 NL <i>PRODUCTS LABEL'S SHEET FS400 NL</i>
	95		15000253	PRODUCTS LABEL'S SHEET FS400 UK <i>PRODUCTS LABEL'S SHEET FS400 UK</i>
	95		15001972	PRODUCTS LABEL'S SHEET CRISTALLO BLK ITA <i>PRODUCTS LABEL'S SHEET CRISTALLO BLK ITA</i>
	95		15001973	PRODUCTS LABEL'S SHEET CRISTALLO BLK FRA <i>PRODUCTS LABEL'S SHEET CRISTALLO BLK FRA</i>
	95		15001974	PRODUCTS LABEL'S SHEET CRISTALLO BLK DE <i>PRODUCTS LABEL'S SHEET CRISTALLO BLK DE</i>

Model Machine

MACSAE114

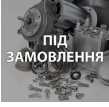









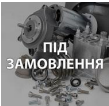

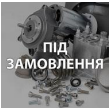













SAECO CRISTALLO 400 ЧЁРНАЯ

	95		15001975	PRODUCTS LABEL'S SHEET CRISTALLO BLK POR <i>PRODUCTS LABEL'S SHEET CRISTALLO BLK POR</i>
	95		15001976	PRODUCTS LABEL'S SHEET CRISTALLO BLK ESP <i>PRODUCTS LABEL'S SHEET CRISTALLO BLK ESP</i>
	95		15001978	PRODUCTS LABEL'S SHEET CRISTALLO BLK NL <i>PRODUCTS LABEL'S SHEET CRISTALLO BLK NL</i>
	95		15001979	PRODUCTS LABEL'S SHEET CRISTALLO BLK ENG <i>PRODUCTS LABEL'S SHEET CRISTALLO BLK ENG</i>
	95		15004032	PRODUCTS LABEL'S SHEET CRISTALLO C.B FRA <i>PRODUCTS LABEL'S SHEET CRISTALLO C.B FRA</i>
	95		15004033	PRODUCTS LABEL'S SHEET CRISTALLO C.B DE <i>PRODUCTS LABEL'S SHEET CRISTALLO C.B DE</i>
	95		15004034	PRODUCTS LABEL'S SHEET CRISTALLO C.B POR <i>PRODUCTS LABEL'S SHEET CRISTALLO C.B POR</i>
	95		15004035	PRODUCTS LABEL'S SHEET CRISTALLO C.B ESP <i>PRODUCTS LABEL'S SHEET CRISTALLO C.B ESP</i>
	95		15004036	PRODUCTS LABEL'S SHEET CRISTALLO C.B NL <i>PRODUCTS LABEL'S SHEET CRISTALLO C.B NL</i>
	95		15004045	PRODUCTS LABEL'S SHEET CRISTALLO C.B ITA <i>PRODUCTS LABEL'S SHEET CRISTALLO C.B ITA</i>
	95		15004046	PRODUCTS LABEL'S SHEET CRISTALLO C.B ENG <i>PRODUCTS LABEL'S SHEET CRISTALLO C.B ENG</i>
	96		1863.A13	ASS.SUPPORT COIN BOX <i>ASS.SUPPORT COIN BOX</i>
	97		15000256	INSTR./ACCEPTED COINS LABEL FS400 F <i>INSTR./ACCEPTED COINS LABEL FS400 F</i>
	97		15000257	INSTR. LABEL/ACCEPTED COINS FS400 <i>INSTR. LABEL/ACCEPTED COINS FS400</i>

Model Machine

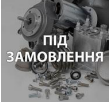
MACSAE114

















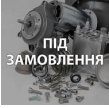





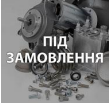

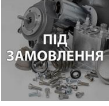
SAECO CRISTALLO 400 ЧЁРНАЯ

	97		15000258	INSTR.LABEL/ACCEPTED COINS FS400 P <i>INSTR.LABEL/ACCEPTED COINS FS400 P</i>
	97		15000259	INSTR./ACCEPTED COINS LABEL FS400 E <i>INSTR./ACCEPTED COINS LABEL FS400 E</i>
	97		15000260	INSTR./ACCEPTED COINS LABEL FS400 CH <i>INSTR./ACCEPTED COINS LABEL FS400 CH</i>
	97		15000261	INSTR./ACCEPTED COINS LABEL FS400 NL <i>INSTR./ACCEPTED COINS LABEL FS400 NL</i>
	97		15000262	INSTR./ACCEPTED COINS LABEL FS400 UK <i>INSTR./ACCEPTED COINS LABEL FS400 UK</i>
	97		15000263	INSTR./ACCEPTED COINS LABEL FS400 I <i>INSTR./ACCEPTED COINS LABEL FS400 I</i>
	97		15001980	INSTRUCTION LABEL CRISTALLO BLK ITA <i>INSTRUCTION LABEL CRISTALLO BLK ITA</i>
	97		15001981	INSTRUCTION LABEL CRISTALLO BLK FRA <i>INSTRUCTION LABEL CRISTALLO BLK FRA</i>
	97		15001982	INSTRUCTION LABEL CRISTALLO BLK DE <i>INSTRUCTION LABEL CRISTALLO BLK DE</i>
	97		15001983	INSTRUCTION LABEL CRISTALLO BLK POR <i>INSTRUCTION LABEL CRISTALLO BLK POR</i>
	97		15001984	INSTRUCTION LABEL CRISTALLO BLK ESP <i>INSTRUCTION LABEL CRISTALLO BLK ESP</i>
	97		15001986	INSTRUCTION LABEL CRISTALLO BLK NL <i>INSTRUCTION LABEL CRISTALLO BLK NL</i>
	97		15001987	INSTRUCTION LABEL CRISTALLO BLK ENG <i>INSTRUCTION LABEL CRISTALLO BLK ENG</i>
	97		15004037	INSTRUCTION LABEL CRISTALLO C.B ITA <i>INSTRUCTION LABEL CRISTALLO C.B ITA</i>

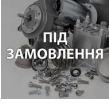
Model Machine

MACSAE114











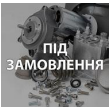















SAECO CRISTALLO 400 ЧЁРНАЯ

	97		15004038	INSTRUCTION LABEL CRISTALLO C.B FRA <i>INSTRUCTION LABEL CRISTALLO C.B FRA</i>
	97		15004039	INSTRUCTION LABEL CRISTALLO C.B DE <i>INSTRUCTION LABEL CRISTALLO C.B DE</i>
	97		15004040	INSTRUCTION LABEL CRISTALLO C.B POR <i>INSTRUCTION LABEL CRISTALLO C.B POR</i>
	97		15004041	INSTRUCTION LABEL CRISTALLO C.B ESP <i>INSTRUCTION LABEL CRISTALLO C.B ESP</i>
	97		15004042	INSTRUCTION LABEL CRISTALLO C.B NL <i>INSTRUCTION LABEL CRISTALLO C.B NL</i>
	97		15004043	INSTRUCTION LABEL CRISTALLO C.B ENG <i>INSTRUCTION LABEL CRISTALLO C.B ENG</i>
	98		0701.995	PRICE LABELS BLACK EURO <i>PRICE LABELS BLACK EURO</i>
	98		0775.989	PRICE LABELS WHITE EURO <i>PRICE LABELS WHITE EURO</i>
	99		11003417	RED PEARLY UPPER COLUMN PANEL <i>PANNELLO COLONNA SUPERIORE ROSSO PERLATO</i>
	99		11014273	BLACK FS400 SUPERIOR COLUMN PANEL <i>BLACK FS400 SUPERIOR COLUMN PANEL</i>
	10001		11003416	RED PEARLY COIN INTRODUCTION PANEL <i>PANNELLO INTROD.UZ.MONETE ROSSO PERLATO</i>
	10001		11006391	PANEL COIN INPUT <i>PANEL COIN INPUT</i>
	10001		11014265	FS400 INTRODUCTION COINS PANELBLK <i>FS400 INTRODUCTION COINS PANEL BLK</i>

Model Machine

MACSAE114



























SAECO CRISTALLO 400 ЧЁРНАЯ

	10001		11014267	PANEL COIN INPUT BLACK <i>PANEL COIN INPUT BLACK</i>
	1010		15000325	ITALIAN TIME LABEL D=60MM <i>ITALIAN TIME LABEL D=60MM</i>
	1020		1863.060	LOGO SAECO GLASS <i>VETRINO LOGO SAECO</i>
	1030		11006390	PLATE CLOSED BANKNOTE READERS <i>PLATE CLOSED BANKNOTE READERS</i>
	1040		U044.016	SCREW TSP M4,0X16 UNI 7688 GALV. <i>VITE TSP M4, 0X16 UNI 7688 ZNP</i>
	1050		9111.355	SPRING FOR CHANGE BUTTON <i>MOLLA X PULSANTE RENDIRESTO</i>
	1060		11000392	BUTTON RECOVERY COINS <i>PULSANTE RECUPERO MONETE CROMATO OPACO</i>
	1060		11001795	COIN RECOVERY BUTTON RED <i>COIN RECOVERY BUTTON RED</i>
	1060		11006846	PULSANTE RECUPERO MONETE GRY <i>PULSANTE RECUPERO MONETE GRY</i>
	1070		11021831	ASSEMBLY COIN BOX <i>ASSEMBLY COIN BOX</i>
	1080		11001836	FS400 STANDARD GRILL <i>GRIGLIA STANDARD FS400</i>
	1090		0875.365	SUP.COIN BOX <i>SUP.COIN BOX</i>
	1100		9111.614	COIN BOX ANCHORING PIN <i>COIN BOX ANCHORING PIN</i>
	1110		0875.357	ASS.FIXING PLATE COIN BOX <i>ASS.FIXING PLATE COIN BOX</i>

Model Machine

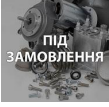
MACSAE114









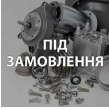

SAECO CRISTALLO 400 ЧЁРНАЯ

	1120		U110.005	SCREW AUT.TCB 3,9X9,5 DIN 7981F VITE AUT.TCB 3,9X9,5 DIN 798
	1130		1602.147	BUSH FOR DOOR CONNECTING ROD BUSH FOR DOOR CONNECTING ROD
	1140	 ПІД ЗАМОВЛЕННЯ	11032971	COIN BOX SUPPORT COIN BOX SUPPORT
	1150		123160302	NUT M3 HIGH UNI 5587 GALVANIZED NUT M3 HIGH UNI 5587 GALVANIZED
	1160		U207.003	PLAIN WASHER 3,2X7 UNI 6592 GALV. PLAIN WASHER 3,2X7 UNI 6592 GALV.
	1170		U701.011	STEEL SNAP RING 5 UNI 7434 ANELLO ELASTICO 5 UNI 7434
	1180	 ПІД ЗАМОВЛЕННЯ	11004932	ADJUSTMENT PIN PLATE COIN BOX ADJUSTMENT PIN PLATE COIN BOX
	1190		0701.R29	KEY KA 35 CHIAVE VIRO KA 35 X SERRAT.S
	1190	 ПІД ЗАМОВЛЕННЯ	20007333	KEY MERONI 337 KEY MERONI 337
	1200		12001902	LOCK MERONI 337 LOCK MERONI 337
	1200	 ПІД ЗАМОВЛЕННЯ	20007143	KIT SPARE PART KIT SPARE PART
	1210	 ПІД ЗАМОВЛЕННЯ	11012748	COIN BOX CASE LID ASS. NEW COIN BOX CASE LID ASS. NEW
	1220	 ПІД ЗАМОВЛЕННЯ	0875.271	HANDLE FOR COIN CASE HANDLE FOR COIN CASE
	1230	 ПІД ЗАМОВЛЕННЯ	11021832	MONEY BOX ASSEMBLY MONEY BOX ASSEMBLY

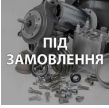
Model Machine

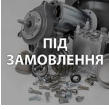
MACSAE114

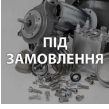
SAECO CRISTALLO 400 ЧЁРНАЯ

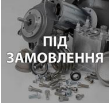

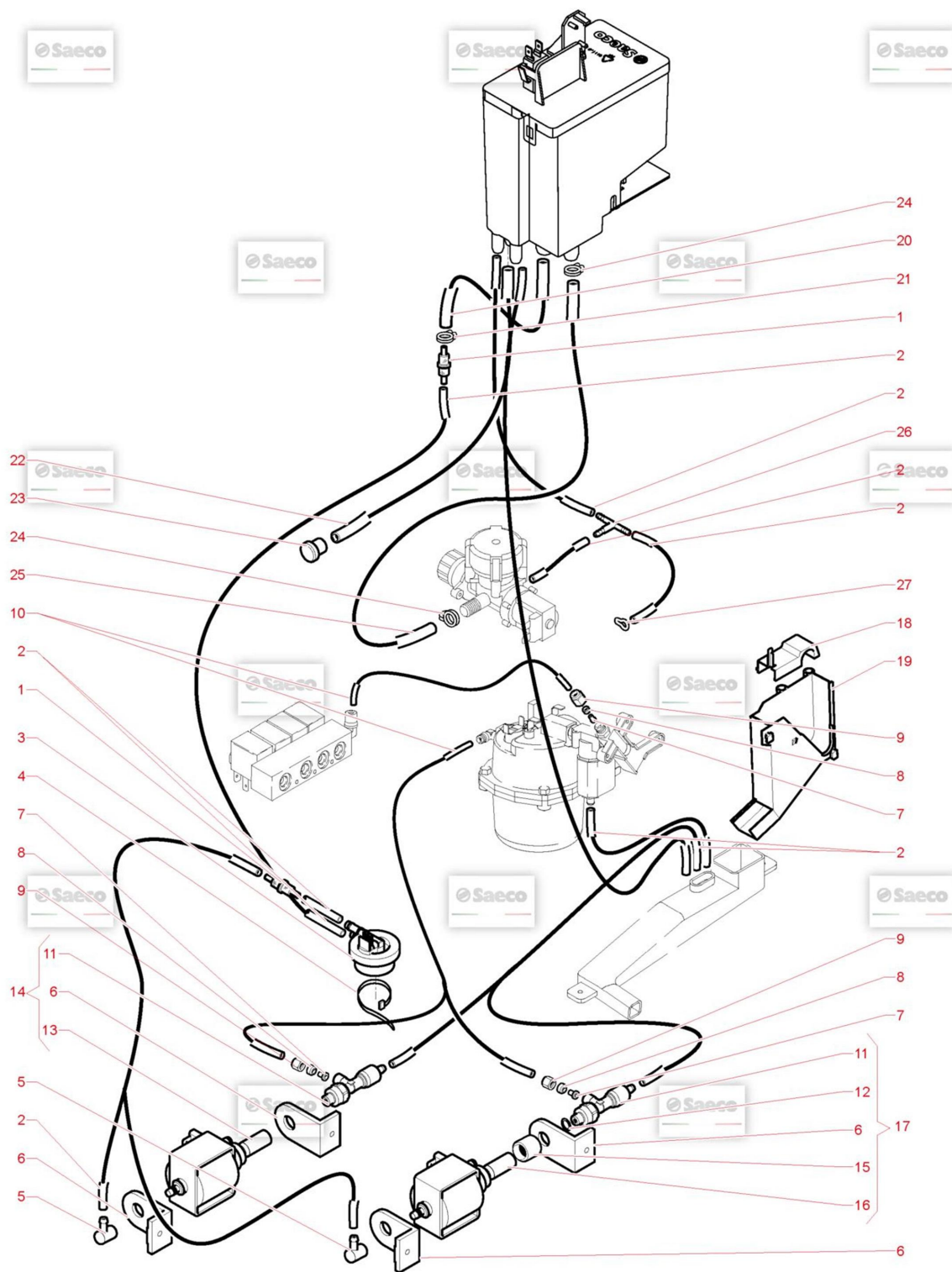























	1240		NF11.026	EXPANSION RIVET D.3,9X8 ALU. <i>RIVETTO AD ESPANSIONE D.3,9X8 ALL.</i>
	1250	 ПІД ЗАМОВЛЕННЯ	11001583	LEVER FOR LOCK <i>LEVER FOR LOCK</i>
	1250	 ПІД ЗАМОВЛЕННЯ	11031071	LEVER FOR LOCK <i>LEVER FOR LOCK</i>
	1260	 ПІД ЗАМОВЛЕННЯ	11011665	COIN BOX HOPPER <i>COIN BOX HOPPER</i>
	1270	 ПІД ЗАМОВЛЕННЯ	1863.064	COVER COIN BOX <i>COVER COIN BOX</i>
	1280	 ПІД ЗАМОВЛЕННЯ	15004049	ADHESIVE GRAN GUSTO <i>ADHESIVE GRAN GUSTO</i>



Model Machine

MACSAE114

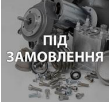









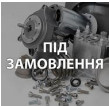

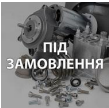













SAECO CRISTALLO 400 ЧЁРНАЯ

Web	Pos.	Foto	Item - Replace by	Description
				<i>Press - CTRL + CLICK go to item in a new window Натисніть - Ctrl + права кнопка миші щоб відкрити запчастину в новому вікні</i>
	1		144650300	ФІЛЬТР ОЧИСТКИ ВОДИ ДЛЯ КАВОМАШИНИ SAECO NEW (NV99.001) (88... ASPIRATION FILTER GAUZE NET 500 (NEW)
	2		9972.057	КОРИЧНЕВА ГУМОВА ТРУБКА 5X8 2 МЕТРИ TUBO SILICONE MARRON 5X8 L.2000 MM
	3		NV99.099	TURBINE D=1,2 ASSY. TURBINA DIGMESA FHKSC 1,2 ARNITE OC
	4		144320200	SELF LOCK STRIP W=2.6 L=200 SELF LOCK STRIP W=2.6 L=200
	5		147920150	90° INLET PUMP CONNECTOR RACCORDO A 90° IN SANTOPRENE
	6		149185850	ТРИМАЧ (ГУМОВИЙ)ПОМПИ ДЛЯ КАВОМАШИН SAECO MAGIC 4002012 (... SUPPORTO POMPA EATON MAGIC 4
	7		9991.009	INSIDE BUSH D.4 INSIDE BUSH D.4
	8		9991.008	ЗОВНІШНЯ ОБЖИМКА Д,6 SAECO 121800420 BIANCHI 19046526 EXTERNAL BUSH D.6
	9		9991.007	NUT FOR CONNECTOR 1/8" NUT FOR CONNECTOR 1/8 NUOVO PREZZO 0,89
	10		9971.015	TEFLON TUBE 4X6 L.2 MT TUBO TEFLON 4X6 L.2 METRI
	11		11005590	SAFETY VALVE/NON RETURN ASS. NEW ASS.VALVOLA SICUREZZA/NON RI
	12		NM02.020	OR 2031 TERMOIL OR 2031 TERMOIL
	13		9070.042.00A	ULKA НАСОС (ПОМПА) EX5GW 230/240V 50HZ SD1 БЪЯНКО 15 BAR ULKA PUMP EX5 SD1

Model Machine

MACSAE114

SAECO CRISTALLO 400 ЧЁРНАЯ

	13		9070.042.00N	PUMP 220V <i>ULKA PUMP EX5 SD1</i>
	14		9070.043.00A	ULKA PUMP+NON RETURN <i>ULKA PUMP EX5 SD1 +NON RETURN</i>
	14		9070.043.00N	PUMP+NON RETURN <i>ULKA PUMP EX5 SD1 +NON RETURN</i>
	15		9071.098	REINFORCEMENT FOR ULKA PUMP <i>REINFORCEMENT FOR ULKA PUMP</i>
	16		9070.044.00F	PUMP 120V-60HZ <i>ULKA PUMP EP5 D1</i>
	17		9070.045.00F	PUMP 120V <i>ULKA PUMP ASS.EP5 D1 120V</i>
	18		9161.262.060	DRIP CHANNEL COVER <i>COPERTURA CANALINO RACCOGLIGOCCE</i>
	19		9111.597.050	COFFEE DISCHARGE CHANNEL SHORT <i>CANALINO SCARICO CAFFE' CORTO</i>
	20		9972.141	SILICONE TUBE 7X11 L.160MM <i>SILICONE TUBE 7X11 L.160 MM</i>
	21		NV99.072	HOSE CLAMP D. 11.6/12.3 <i>HOSE CLAMP D. 11.6/12.3</i>
	22		9972.335	SILICONE TUBE 7X11 L.135MM <i>TUBO SILICONE 7X11 L.1240 MM</i>
	23		NV03.006	CAP KAPSTO LPN 615/010 <i>TAPPO KAPSTO LPN 615/010</i>
	24		NV99.050	HOSECLAMP D. 13.3/14.1 <i>HOSECLAMP D. 13.3/14.1</i>
	25		11001315	***SILICONE TUBE 7X11 L.950MM <i>SILICONE TUBE 8X12 L 950MM</i>

Model Machine

MACSAE114

SAECO CRISTALLO 400 ЧЁРНАЯ



26



NV99.004

CONNECTOR T MORONI 8026047 D=8
CONNECTOR T MORONI 8026047 D=8



27





























9111.141

DISCHARGE TUBE CLOSURE SPRING
DISCHARGE TUBE CLOSURE SPRING

Model Machine

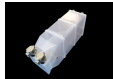
MACSAE114











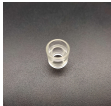















SAECO CRISTALLO 400 ЧЁРНАЯ

Web	Pos.	Foto	Item - Replace by	Description
				<i>Press - CTRL + CLICK go to item in a new window Натисніть - Ctrl + права кнопка миші щоб відкрити запчастину в новому вікні</i>
	1		9111.681	DOUBLE EXTENSION 145 <i>PROLUNGA DOPPIA 145</i>
	2		9111.680	BASE CONTAINER DOUBLE SOLUBLE <i>BASE CONTENITORE SOLUBILI DOPPIO</i>
	3		11012130	BACK BUSH REINFORCE <i>BACK BUSH REINFORCE</i>
	4		9111.701	SCROLL SCREW DOUBLE CONTAINER <i>COCLEA CONTENITORE DOPPIO</i>
	5		11005180	SCROLL SCREW FOR NEW DISPENSER APERTURE <i>COCLEA X BOCCHETTA EROGAZIONE APERTURE SCROLL SCREW FOR ...</i>
	6		NM03.013	OR 2,3X15 NBR <i>OR 2,3X15 NBR</i>
	7		NM03.022	OR ORM 0060-10 NBR <i>OR ORM 0060-10 NBR</i>
	8		U701.003	SNAP RING 7 UNI 7434 <i>ANELLO ELASTICO 7 UNI 7434</i>
	9		9111.702	WHEEL DOUBLE CONTAINER <i>RUOTA CONTENITORE DOPPIO</i>
	10		11031891	ASSEMBLED DOUBLE TANK EASY DRY2 <i>ASSEMBLED DOUBLE TANK EASY DRY 2</i>
	11		11031885	PHEDRA ASSEMBLED DOUBLE TANK <i>PHEDRA ASSEMBLED DOUBLE TANK</i>
	12		9111.683	SOLUBLE COVER <i>COPERCHIETTO SOLUBILI</i>
	13		9111.682	COVER CONTAINER DOUBLE SOLUBLE <i>COPERCHIO CONT.SOLUBILI DOPPIO</i>

Model Machine

MACSAE114























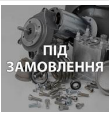

SAECO CRISTALLO 400 ЧЁРНАЯ

	14		11032945	SPACE FOR GEAR BPA FREE <i>SPACE FOR GEAR BPA FREE</i>
	15		9111.703	DOUBLE PIN FOR WHEEL <i>PERNO DOPPIA PER RUOTA</i>
	16		11028378	FRONT BUSH <i>FRONT BUSH</i>
	17		9111.629.060	APERTURE FOR SOLUBLES HOPPER <i>APERTURE FOR SOLUBLES HOPPER</i>
	18		9111.338.270	BULKHEAD FOR APERT. CLOSURE ORANGE <i>PARATIA CHIUSURA BOCCHETTA ARANCIO</i>
	19		11006124	WIRE AGITATOR UNIFIED <i>FILO AGITATORE UNIFICATO WIRE AGITATOR UNIFIED</i>
	20		9111.731	SPRING <i>MOLLA AGITATORE</i>
	21		11007155	ПЛАСТИКОВИЙ ТРИМАЧ ВЗБИВАЛКИ SAECO 9111.735 <i>AGITATOR SUPPORT</i>
	22		11031888	ASSEMBLED DOUBLE TANK <i>ASSEMBLED DOUBLE TANK</i>
	23		11031883	ASSEMBLY SINGLE CONTAINER <i>ASSEMBLY SINGL CONTAINER</i>
	24		11031886	ASSEMBLY SINGLE CONTAINER <i>ASSEMBLY SINGLE CONTAINER</i>
	25		11001578	COVER CONTAINER SINGLE SOLUBLE <i>COPERCHIO CONTENITORE SOLUBILE SINGOLO</i>
	26		11001577	EXTENSION CONTAINER SINGLE SOLUBLE <i>PROLUNGA CONTENITORE SOLUBILE SINGOLO</i>
	27		11001576	BASE CONTAINER SINGLE SOLUBLE <i>BASE CONTENITORE SOLUBILE SINGOLO</i>

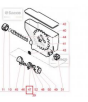
Model Machine

MACSAE114

SAECO CRISTALLO 400 ЧЁРНАЯ

	28		11001580	PIN WHEEL CONTAINER SINGLE SOLUBLE <i>PERNO RUOTA DENTATA CONT.SOLUB.SINGOLO</i>
	29		11031692	FELT RING DE=47,4 DI=41,4H=4 <i>FELT RING DE=47,4 DI=41,4H=4</i>
	30		9121.155	HOOD FOR RATIOMOTOR <i>CUFFIA X MOTORIDUTTORE</i>
	31		9121.106.00P	SUGAR RATIOMOTOR 24V DC <i>MOTORIDUTTORE ZUCCHERO 24V D.C.</i>
	32		9111.131	COUPLING FOR SOLUBLES MOTOR <i>GIUNTO X MOTORE SOLUBILI</i>
	33		U116.005	SCREW AUT.PT TCB 3,0X8 WN 1441 <i>VITE AUT.PT TCB 3,0X8 WN 1441 ZNP</i>
	34		11031679	DISPENSER FAN EASY DRY <i>DISPENSER FAN EASY DRY</i>
	35		11005182	WHEEL Z=9 <i>WHEEL Z=9</i>
	36		11031678	EASY DRY DISPENSER APERTURE <i>EASY DRY DISPENSER APERTURE</i>
	37		11031691	CARTER FOR GEAR EASY DRY <i>CARTER FOR GEAR EASY DRY</i>
	38		11031690	WHEEL Z=18 EASY DRY <i>WHEEL Z=18 EASY DRY</i>
	39		11005168	LID CARTER GEAR <i>LID CARTER GEAR</i>
	40		21001290	KIT NEW POWDER DISPENSING SYSTEM <i>KIT NEW POWDER DISPENSING SYSTEM</i>

Model Machine

MACSAE114

SAECO CRISTALLO 400 ЧЁРНАЯ



41



21002190

KIT EASY DRY 2

KIT EASY DRY

Model Machine

MACSAE114

SAECO CRISTALLO 400 ЧЁРНАЯ

MACSAE114.T.0006



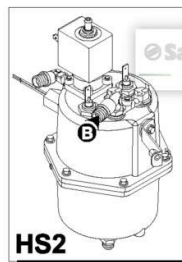
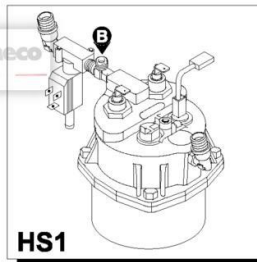
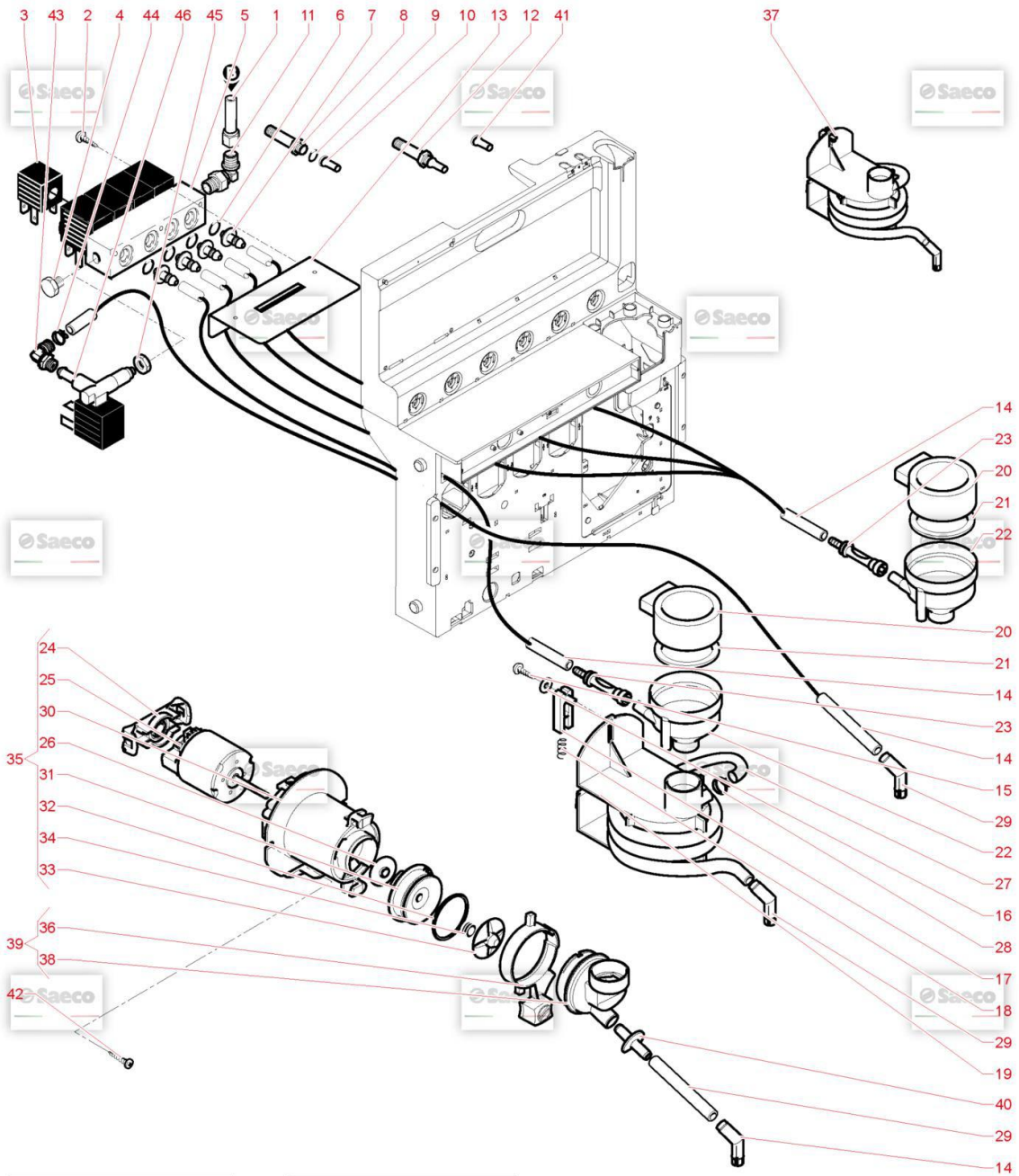









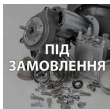

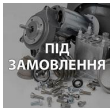











TAVOLA NR. 6 - ARTICOLO SAECO CRISTALLO 400 ЧЁРНАЯ



Model Machine

MACSAE114





























SAECO CRISTALLO 400 ЧЁРНАЯ

Web	Pos.	Foto	Item - Replace by	Description
				<i>Press - CTRL + CLICK go to item in a new window Натисніть - Ctrl + права кнопка миші щоб відкрити запчастину в новому вікні</i>
	1		11025292	TEFLON TUBE 3X6 L.230 1/8"-1/8 TEFLON TUBE 3X6 L.230 1/8"-1/8
	1		11025297	TEFLON TUBE 3X6 L.310 1/8"-1/8 TEFLON TUBE 3X6 L.310 1/8"-1/8
	2		129516803	SCREW TCB3,5X19 DIN 7981 NICK SCREW TCB3,5X19 DIN 7981 NICK
	3		0862.R07	SOLENOID FOR MM VALVE 3 WAY 24V DC SOLENOID FOR MM VALVE 3 WAY 24V DC
	3		20005373	SOLENOID X HS1 11023762 SOLENOID X OLAB 24V DC 6000BH/BODN
	4		12001169	ЛАТУННА ЗАГЛУШКА BRASS CAP 1/8 GAS CONICAL TEA BRASS CAP 1/8 GAS CONICAL TEA
	5		11009225	BLOCK 4 ELECTROVALVE DC OLAB BLOCK 4 ELECTROVALVE DC OLAB
	5		11011470	BLOCK 4 ELECTROVALVE DC OLAB TEA BLOCK 4 ELECTROVALVE DC OLAB TEA
	5		9121.156.00P	4 ELECTROVALVE DC BLOCK 4 ELECTROVALVE DC BLOCK
	6		NM01.004	OR 2025 SILICONE OR 2025 SILICONE
	7		11011453	RUBBER HOLDER CONNECTOR TEA RUBBER HOLDER CONNECTOR TEA
	8		0875.R09	TUBE CANOTTO
	9		0875.R10	OR X TUBE OR X CANOTTO

Model Machine

MACSAE114



























SAECO CRISTALLO 400 ЧЁРНАЯ

	10		0875.R11	NUCLEUS FOR SPRING <i>NUCLEO CON MOLLA</i>
	11		11025082	1/8"G M/CONICAL ORIENT. NUT/OGV <i>1/8G M/CONICAL ORIENT. NUT/OGV</i>
	12		20005374	ASS.NUCLEO FIS+MOB.X 11009225 <i>ASS.NUCLEUS 6000BH/BODN X 11009225</i>
	13		9111.713	PLATE <i>PIASTRA ELETTROVALVOLE</i>
	14		9972.057	КОРИЧНЕВА ГУМОВА ТРУБКА 5X8 2 МЕТРИ <i>TUBO SILICONE MARRON 5X8 L.2000 MM</i>
	15		U116.005	SCREW AUT.PT TCB 3,0X8 WN 1441 <i>VITE AUT.PT TCB 3,0X8 WN 1441 ZNP</i>
	16		U207.004	PLAIN WASHER 4,3X16 UNI 6592 GAL <i>PLAIN WASHER 4,3X16 UNI 6592 GAL</i>
	17		9111.209.060	CURSOR FOR SPIRAL MIXER FIXING <i>CURSOR FOR SPIRAL MIXER FIXING</i>
	18		9111.211	SPRING FOR MIXER CURSOR <i>MOLLA X CURSORE MISCELATORE</i>
	19		9111.643.060	RAPID FIXING MIXER <i>RAPID FIXING MIXER</i>
	20		9111.010.060	LID FOR FUNNEL BROWN <i>COPERCHIO X IMBUTO MARRON</i>
	21		9111.011.060	SEAL FOR FUNNEL BROWN <i>GUARNIZIONE X IMBUTO MARRON</i>
	22		9111.009.060	FUNNEL FOR POWDERS BROWN <i>IMBUTO X POLVERI MARRON</i>
	23		1863.A07	ESPRESSO NOZZLE <i>ASS.UGELLO ESPRESSO</i>

Model Machine

MACSAE114





















SAECO CRISTALLO 400 ЧЁРНАЯ

	24		9111.771.270	MOTOR COUPLING ORANGE RAL <i>MOTOR COUPLING ORANGE RAL</i>
	25		9121.248.00P	MOTOR MIKCEPA '05 24V DC - M.B.T. COD. 912124800 SAECO 9121.248.00 <i>MOTORE MIXER '05 24V DC - M.B.T.</i>
	26		9111.773.060	MOTOR PROTECTION RING <i>ANELLO PROTEZIONE MOTORE MIXER '05</i>
	27		9972.055	ТРУБКА СИЛІКОНОВА 8X12 2 МЕТРИ <i>SILICONE TUBE 8X12 L.2000MM</i>
	28		NV99.072	HOSE CLAMP D. 11.6/12.3 <i>HOSE CLAMP D. 11.6/12.3</i>
	29		9111.349	ELBOW DISPENSING NOZZLE <i>UGELLO EROGAZIONE GOMITO</i>
	30		9111.769.150	MIXER FLANGE <i>MIXER FLANGE</i>
	31		9111.770.060	COVER MIXER FLANGE <i>COVER MIXER FLANGE</i>
	32		NM03.012	OR ORM 0320-25 NBR <i>OR ORM 0320-25 NBR</i>
	33		9111.772.060	DISK FAN <i>VENTOLINA A DISCO MIXER '05</i>
	34		NM05.015	ПРОКЛАДКА V-RING 405 МІКСЕРА ДЛЯ КАВОМАШИН SAECO <i>V-RING MIXER '05</i>
	35		9110.160.06P	ДВИГУН МІКСЕРА ДЛЯ КАВОМАШИНИ SAECO 05 24V DC SAECO 9110.1... <i>ASS.MIXER '05 24V DC GROUP 500 SAECO</i>
	36		9111.230.270	MIXER LOCKING RING NUT ORANGERAL <i>GHIERA BLOCCAGGIO MIXER ARANCIO RAL</i>

Model Machine

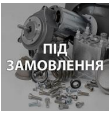
MACSAE114

SAECO CRISTALLO 400 ЧЁРНАЯ

	37		1863.A10	ASS.MIXER FS400 ASS.MIXER A SPIRALE FS400
	38		9111.227.060	MIXER CASING CORPO MIXER
	39		9110.027.060	MIX CASING ASS. ASS.CORPO MIX SAECO CRISTALLO,ATLANTE,QUARZO,RUBINO
	40		9111.232.060	STD TUBE HOLDER SLEEVE MANICOTTO PORTATUBO STANDARD
	40		9111.233.060	DECAFF.TUBE HOLDER SLEEVE MANICOTTO PORTATUBO DECAFFEINATO
	41		20007305	ЧАСТИНА ЕЛЕКТРОМАГНІТНОГО КЛАПАНА З ПОДВИЖНИМ СЕРДЕЧНИК... SPARE EV MOBILE CORE 11023762
	42		U116.006	SCREW AUT.PT TCB 3,5X12 WN 1441 ZNP VITE AUT.PT TCB 3,5X12 WN 1441 ZNP
	43		NR10.014	МЕТАЛЕВИЙ ПЕРЕХІДНИК 1/8" D.6 RACCORDO 1/8" D.6 ORIENTABILE COD. OLAB
	44		NV99.036	HOSECLAMP D=8,5 09993.41.00 HOSECLAMP D=8,5 09993.41.00
	45		9991.035	NUT 1/8 H 4.5 DADO 1/8 H.4,5
	46		11027286	ELETTROVALVE 24V DC TEA ELETTROVALVE 24V DC TEA

Model Machine

MACSAE114

SAECO CRISTALLO 400 ЧЁРНАЯ

MACSAE114.T.0007

TAVOLA NR. 7 - ARTICOLO SAECO CRISTALLO 400 ЧЁРНАЯ

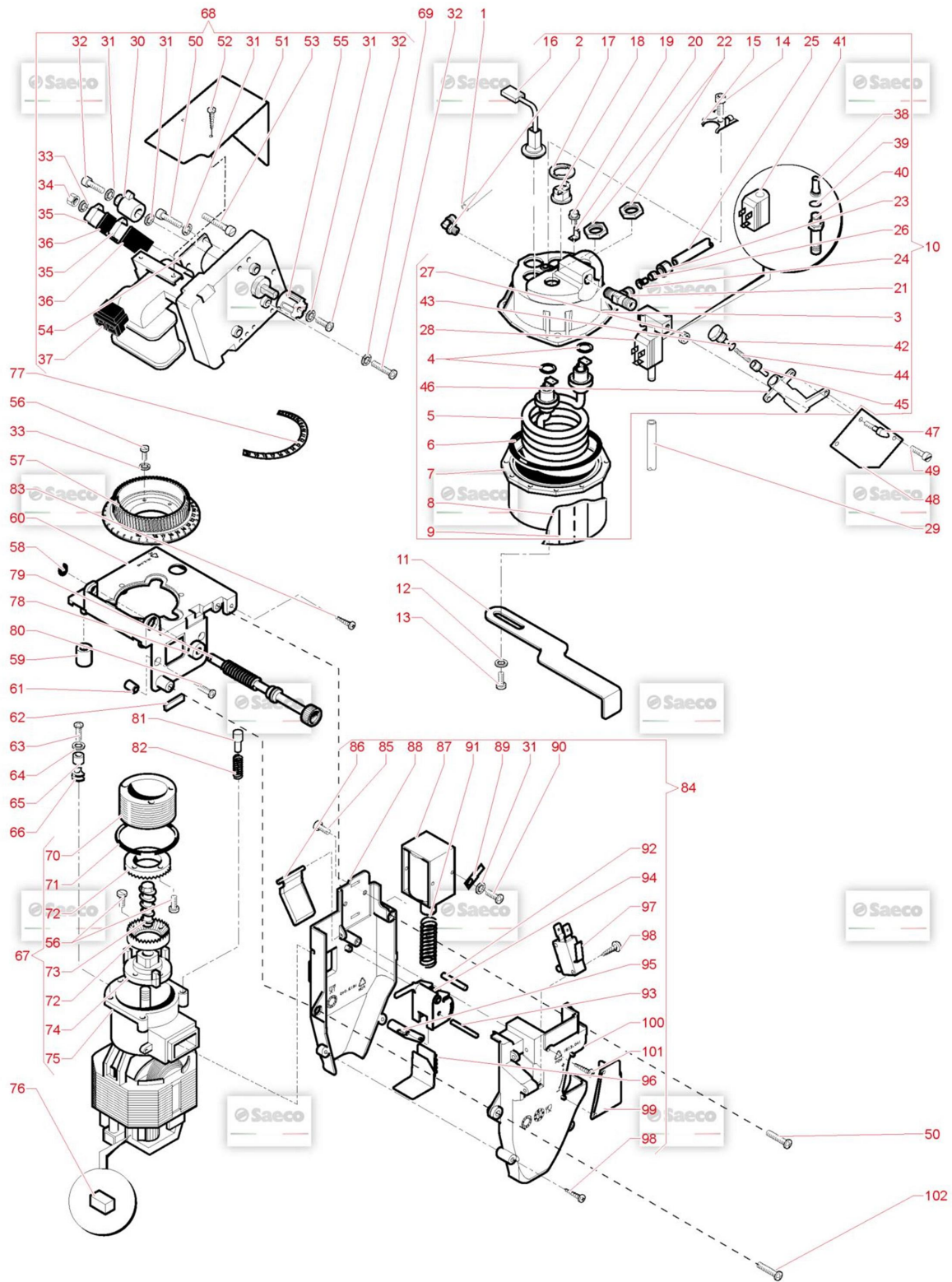

Model Machine

MACSAE114

SAECO CRISTALLO 400 ЧЁРНАЯ

Web Pos. Foto Item - Replace by Description



Press - CTRL + CLICK go to item in a new window

Натисніть - Ctrl + права кнопка миші щоб відкрити запчастину в новому вікні



1

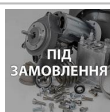

9971.015

TEFLON TUBE 4X6 L.2 MT

TUBO TEFLON 4X6 L.2 METRI



2



NR10.014

МЕТАЛЕВИЙ ПЕРЕХІДНИК 1/8" D.6

RACCORDO 1/8" D.6 ORIENTABILE COD. OLAB



3



11002259

UPPER DOSER CASING M6 TEA

UPPER DOSER CASING M6 TEA



4

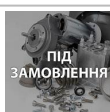

11000972

OR 3050 FKM 80 FD PEROXIDICA

OR 3050 FKM 80 FD PEROXIDICA



5



11007593

RES CALD. V120 W1000 INC.800

RES CALD. V120 W1000 INC.800



5

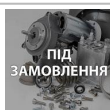

9011.255.00A

RES CALD.V230 W1000

RES.CALD. 230V 1000W



6



NM04.010

OR ORM 0730-40 FPM 70+-5 IRHDBLACK

OR ORM 0730-40 FPM 70 +-5 IRHD NERO



7



9011.226

LOWER OVERSIZE CASING M6 VENDING

UPPER OVERSIZE CASING M6 VENDING



8

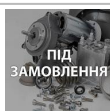

9011.254

BRASS BOILER ISOLATOR

BRASS BOILER ISOLATOR



9

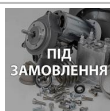

9991.161

WATER +STEAM BOILER STRAP L=250 MM

NASTRO CALDAIA ACQUA E VAPORE



10

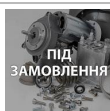

11003769

BOILER ASS. CRISTALLO400 120V

BOILER ASS. CRISTALLO400 120V



10



11012477

BOILER 230V TEA

BOILER ASS.CRISTALLO400 230V TEA



11



9111.610





























CHASE BOILER

STAFFA CALDAIA

Model Machine

MACSAE114



























SAECO CRISTALLO 400 ЧЁРНАЯ

	12		U207.001	PLAIN WASHER 5,3X10 UNI 6592 GAL <i>ROSETTA PIANA 5,3X10 UNI 6</i>
	13		U043.021	SCREW TCBC M5,0X8 UNI 7687 GALV. <i>VITE TCBC M5,0X8 UNI 7687 ZNP</i>
	14		12001052	SCREW TCEI M4,0X6 DIN 912 ZIN <i>SCREW TCEI M4,0X6 DIN 912 ZIN</i>
	15		226830200	RETAIN.SPRING 3 THERM. +THERMAL FUSE <i>RETAIN.SPRING 3 THERM. +THERMAL FUSE</i>
	16		11000090	ASS.SENSOR FS400 <i>ASS.SENSORE X FS400</i>
	16		11003810	SENSOR ASS.CRISTALLO400 120V <i>SENSOR ASS.CRISTALLO400 120V</i>
	17		9991.085	THERMOSTAT FIXING WASHER <i>RONDELLA FERMATERMOSTATI</i>
	18		NE09.021	THERMOSTAT 150°NC FASTON 90° <i>TERMOSTATO 150°NC FASTON 90°</i>
	19		U023.020	SCREW TCEI M6X20 UNI 5931 ZIN <i>VITE TCEI M6X20 UNI 5931 8.8</i>
	20		NE15.031	MALE TONGUE PLAIN 6,3 D.6,3 <i>MALE TONGUE PLAIN 6,3 D.6,3</i>
	21		11011454	"T" CONNECTOR FOR BOILER TEAT"" CONNECTOR FOR BOILER TEA <i>RACCORDO A T X CALDAIA TEA</i>
	22		9991.029	NUT FOR RESISTOR <i>DADO X RESISTENZA</i>
	23		9991.007	NUT FOR CONNECTOR 1/8" <i>NUT FOR CONNECTOR 1/8 NUOVO PREZZO 0,89</i>
	24		9991.009	INSIDE BUSH D.4 <i>INSIDE BUSH D.4</i>

Model Machine

MACSAE114















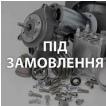











SAECO CRISTALLO 400 ЧЁРНАЯ

	24		9991.129	INTERNAL BUSH D.4 BRASS NIK <i>BOCCOLA INTERNA D.4 OTTONE N</i>
	25		9971.051	TEFLON TUBE 4X6 L.250 MM <i>TUBO TEFLON 4X6 L.250 MM</i>
	26		9991.008	ЗОВНІШНЯ ОБЖИМКА Д,6 SAECO 121800420 BIANCHI 19046526 <i>EXTERNAL BUSH D.6</i>
	27		9991.035	NUT 1/8 H 4.5 <i>DADO 1/8 H.4,5</i>
	28		9121.145.00P	ELECTROVALVE 3 WAYS <i>NEW COD 11023754 ELETTROVALVOLA "MM" 3 VIE DC</i>
	29		9972.057	КОРИЧНЕВА ГУМОВА ТРУБКА 5X8 2 МЕТРИ <i>TUBO SILICONE MARRON 5X8 L.2000 MM</i>
	30		9991.012.050	CAM FOR RATIO MOTOR BLACK <i>CAMMA X MOTORIDUTTORE NERA</i>
	31		128310404	МЕТАЛЕВЕ УБЧАСТЕ КОЛІЩАТКО UNI 8842 A4 <i>WASHER UNI 8842 A4 BURNISHED</i>
	32		129824002	TCB SCREW M4X10 UNI 7687 ZNP <i>VITE TCB M4X10 UNI 7687 ZNP</i>
	33		U208.002	TOOTHED WASHER 3,3X5,8 UNI 3703 G <i>ROSETTA DENT. 3,3X5,8 UNI 3703 ZNP</i>
	34		U302.002	NUT HEXAGONAL M3 UNI 5588 <i>NUT HEXAGONAL M3 UNI 5588</i>
	35		NE05.066	MICROSWITCH CHERRY D419Q1A <i>МІКРОПЕРЕМИКАЧ РЕДУКТОРА РОБОЧОЇ ГРУПИ</i>
	36		9991.014	CARD FOR MICRO SWITCHES <i>CARTONCINO X MICROINTERRUTTORE</i>

Model Machine

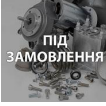
MACSAE114

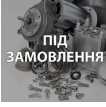









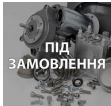









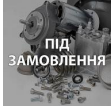

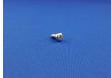

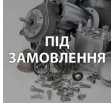

SAECO CRISTALLO 400 ЧЁРНАЯ

	37		11032817	RATIOMOTOR 30 PACK 230/240-50 <i>RATIOMOTOR 30 PACK 230/240-50</i>
	37		11032818	RATIOMOTOR 30 PACK 120/60 <i>RATIOMOTOR 30 PACK 120/60</i>
	37		11032819	RATIOMOTOR 30 PACK 220/60 <i>MOTORIDUTT.IN PLASTICA PACCO 30 220/60</i>
	38		0862.R16	ASS.NUCLEUS <i>ASS.NUCLEO MOB.D.9 SPEC.MOLLA DURA</i>
	39		0862.R17	ORM 0-100 10X1.5 NBR UP COIL <i>ORM 0-100 10X1.5 NBR SOPRA BOBINA</i>
	40		0862.R15	ASS.TUBE 3/2 WAYS <i>ASS.CANNOTTO 3/2 VIE"E"OR.SUP.D.1.7</i>
	41		0862.R07	SOLENOID FOR MM VALVE 3 WAY 24V DC <i>SOLENOID FOR MM VALVE 3 WAY 24V DC</i>
	42		9991.212	CONNECTOR BOILER SUPPORT <i>RACCORDO SUPPORTO CALDAIA</i>
	42		9991.214	CONNECTOR NIK BOILER SUPPORT <i>RACCORDO SUPPORTO CALDAIA NIK</i>
	43		140321462	O-RING 2018 SILICONE <i>OR 2018 IN SILICONE</i>
	44		126765317	STEEL SPRING BOILER PISTON MAGIC <i>STEEL SPRING BOILER PISTON MAGIC</i>
	45		9019.A01	PIN ASS. <i>PIN ASS.</i>
	45		9019.A20	PIN ASS. BRASS NIK <i>PIN ASS. BRASS NIK</i>
	46		9161.213	BOILER TEFLON SUPPORT <i>BOILER TEFLON SUPPORT</i>

Model Machine

MACSAE114

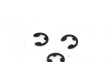























SAECO CRISTALLO 400 ЧЁРНАЯ

	46		9161.271	BRASS BOILER SUPPORT NIK <i>BRASS BOILER SUPPORT NIK</i>
	47		9111.473	INSULATOR FOR BOILER SUPPORT <i>ISOLANTE X SUPPORTO CALDAIA</i>
	48		9011.005	PEG FOR BOILER <i>PERNO X CALDAIA</i>
	49		U044.013	SCREW TSPC M4,0X12 UNI 7688 GALV. <i>VITE TSPC M4,0X12 UNI 7688 ZNP</i>
	50		129825502	TCB SCREW M4X25 UNI 7687 ZNP <i>TCB SCREW M4X25 UNI 7687 ZNP</i>
	51		11004265	CENTRAL UNIT MOTOR STEEL CARTER <i>CENTRAL UNIT MOTOR STEEL CARTER</i>
	52		129511903	SCREW TCB 2,9X6,4 DIN 7981 BZNICK <i>SCREW TCB 2,9X6,4 DIN 7981 BZ NICK</i>
	53		U034.001	SCREW TCI M3,0X30 UNI 6107 GALV. <i>VITE TCI M3,0X30 UNI 6107 ZNP</i>
	54		9991.015	PLATE FOR MICRO <i>PIASTRINA X MICRO</i>
	55		9991.013	JOINT FOR RATIOMOTOR <i>GIUNTO X MOTORIDUTTORE</i>
	56		U043.007	SCREW TCBC M3,0X8 UNI 7687 GALV. <i>SCREW TCBC M3,0X8 UNI 7687 GALV.</i>
	57		1813.103.A20	RING NUT OF GRIND REGULATION <i>RING NUT OF GRIND REGULATION</i>
	58		U701.011	STEEL SNAP RING 5 UNI 7434 <i>ANELLO ELASTICO 5 UNI 7434</i>
	59		1813.046.050	RUBBER GRIND SUPPORT <i>RUBBER GRIND SUPPORT</i>

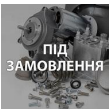
Model Machine

MACSAE114











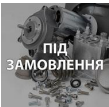















SAECO CRISTALLO 400 ЧЁРНАЯ

	60		1813.045.A20	GRIND SUPPORT GRIND SUPPORT
	61		1813.097.A20	SPACER SPACER
	62		1813.177	SUPPORT SEAL SUPPORT SEAL
	63		12002052	ZN-B TCB SCREW M4X16 ZN-B TCB SCREW M4X16
	64		U203.001	ШАЙБА 4,3X8 UNI 1749 GA PLAIN WASHER 4,3X8 UNI 1749 GAL
	65		9141.003	SPACER FOR RUBBER SPACER FOR RUBBER
	66		9991.005	RUBBER FOR COFFEE GRINDER GOMMINO X MACINA CAFFE
	67		9140.001.00A	COFFEGRINDER MOTOR ASS.220/230V ASS.MOTORE MACINACAFFE'220/2
	67		9140.001.00F	COFFEGRINDER MOTOR ASS.120V COFFEGRINDER MOTOR ASS.120V
	68		11003768	ASS.RATIOMOTOR CRISTALLO400 120V ASS.RATIOMOTOR CRISTALLO400 120V
	68		11005172	ASS.RATIOMOTOR CRISTALLO400 220/60 ASS.RATIOMOTOR CRISTALLO400 220/60
	68		9120.060.00A	ASS.RATIOMOTOR FOR DA 230V FS400 ASS.MOTORIDUTTORE X DA 230V FS400
	69		U207.002	PLAIN WASHER 4,3X9 UNI 6592 GAL ROSETTA PIANA 4,3X9 UNI 6592 ZNP

Model Machine

MACSAE114













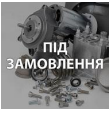

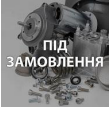

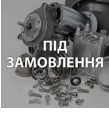

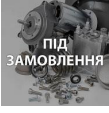





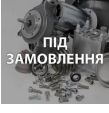

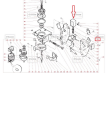
SAECO CRISTALLO 400 ЧЁРНАЯ

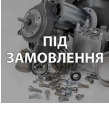
	70		9141.008	KNOB ADJUSTMENT SCREW KNOB ADJUSTMENT SCREW
	71		140321560	O-RING 3187 NBR OR 3187 IN NBR
	72		9141.081	МЕТАЛЕВИЙ ПОДРІБНЮВАЧ D.43 TIN SAECO (1 ШТ) MACINA PIANA D.43 TIN NB) PREZZO ACQUISTO PER 1 PEZZO
	73		9141.001	BRASS NCREMENT SCREW MC BRASS NCREMENT SCREW MC
	74		9141.007	FAN VENTOLINA
	75		9140.002.00A	MOTOR ASS.WITH CAP 230V ASS.MOTORE CON CALOTTA 230V
	75		9140.002.00F	MOTOR ASS.WITH CAP 120V MOTOR ASS.WITH CAP 120V
	76		0701.R34	MOTOR BRUSH SPAZZOLA X MOTORE MACINACAFFE'
	77		15000422	LABEL GRADUATION GRINDING LABEL GRADUATION GRINDING
	78		1813.159	ANTIVIBRATION RUBBER ANTIVIBRATION RUBBER
	79		1813.104.A20	ADJUSTMENT SCREW WITH TUBE HOLDER VITE REGOLAZIONE MACININO
	80		U044.022	SCREW TSPC M5,0X8 UNI 7688 GALV. SCREW TSPC M5,0X8 UNI 7688 GALV.
	81		9141.005	KNOB PIN PERNO MANOPOLA
	82		126769118	SPRING FOR KNOB STOP PIN (H=19) SPRING FOR KNOB STOP PIN (H=19)

Model Machine

MACSAE114

SAECO CRISTALLO 400 ЧЁРНАЯ

	83		U116.006	SCREW AUT.PT TCB 3,5X12 WN 1441 ZNP <i>VITE AUT.PT TCB 3,5X12 WN 1441 ZNP</i>
	84	 ПІД ЗАМОВЛЕННЯ	1813.A10.A2A	DOSER ASS. 6-11 GR. <i>ASS.DOSATORE 6-11 GR.</i>
	84	 ПІД ЗАМОВЛЕННЯ	1813.A10.A2F	DOSER ASS. 6-11 GR.120V UL <i>DOSER ASS. 6-11 GR.120V UL</i>
	84	 ПІД ЗАМОВЛЕННЯ	1813.A10.A2N	DOSER ASS. 6-11 GR. 220V 60HZ <i>DOSER ASS. 6-11 GR. 220V 60HZ</i>
	85	 ПІД ЗАМОВЛЕННЯ	12002151	TSP SCREW M3X4 UNI 7688 SS <i>TSP SCREW M3X4 UNI 7688 SS</i>
	86	 liberty	1813.042.A20	DISPENSER PALLET <i>DISPENSER PALLET</i>
	87		9121.235.00A	ELECTROMAGNET FOR DISPENSER WITH NUCLEUS <i>ELETTROM. PER DOSATORE CON NUCLEO</i>
	87	 ПІД ЗАМОВЛЕННЯ	9121.235.00F	ELECTROMAGNET X DISPENSER W/NUCLEUS 120V <i>ELECTROMAGNET X DISPENSER W/NUCLEUS 120V</i>
	87		9121.235.00N	ЕЛЕКТРОМАГНІТ ДЛЯ ДОЗАТОРА W/NUCLEUS 220V <i>ELECTROMAGNET X DISPENSER W/NUCLEUS 220V</i>
	88	 ПІД ЗАМОВЛЕННЯ	1813.040.A20	DISPENSER SHELL <i>GUSCIO DOSATORE</i>
	89		NE15.003	MALE TONGUE PLAIN 6,3 D.5,2 <i>LINGUETTA MASCHIO PIANA 6,3 D.5,2</i>
	90		129821402	TCB SCREW M3X4 UNI 7687 ZNP <i>TCB SCREW M3X4 UNI 7687 ZNP</i>
	91		1813.127	SPRING FOR ELECTROMAGNET <i>MOLLA X ELETTROMAGNETE DOSAT</i>
	92		1813.092	PIN <i>PIN</i>

Model Machine

MACSAE114

SAECO CRISTALLO 400 ЧЁРНАЯ

	93		1813.091	PIN FOR DISPENSER REGULATION <i>PIN FOR DISPENSER REGULATION</i>
	94		1813.043.A20	DISPENSER REGULATION <i>REGOLATORE DOSATORE</i>
	95		1813.078.A20	ADJUSTMENT LEVER <i>ADJUSTMENT LEVER</i>
	96		1813.044.A20	PALLET FOR REGULATION <i>PALETTA X REGOLATORE</i>
	97		NE05.062	MICROSWITCH + WHEEL <i>MICROINTERRUTTORE C/ROTELLA</i>
	98		U116.004	SCREW AUT.PT TCB 3,0X16 WN 1441 <i>SCREW AUT.PT TCB 3,0X16 WN 1441</i>
	99		1813.191.A20	DISPENSER COVER <i>COPERTURA DOSATORE</i>
	10001		1813.041.A20	OUTSIDE SHELL DISPENSER <i>OUTSIDE SHELL DISPENSER</i>
	1010		129514003	SCREW TCB 2,9X22,2 DIN 7981 NICK <i>SCREW TCB 2,9X22,2 DIN 7981 NICK</i>
	1020		12002039	SCREW TCBD TORX 20 M4X12 ZN-B <i>VITE TCBD TORX 20 M4X12 ZN-B</i>

Model Machine

MACSAE114

SAECO CRISTALLO 400 ЧЁРНАЯ

MACSAE114.T.0008

TAVOLA NR. 8 - ARTICOLO SAECO CRISTALLO 400 ЧЁРНАЯ

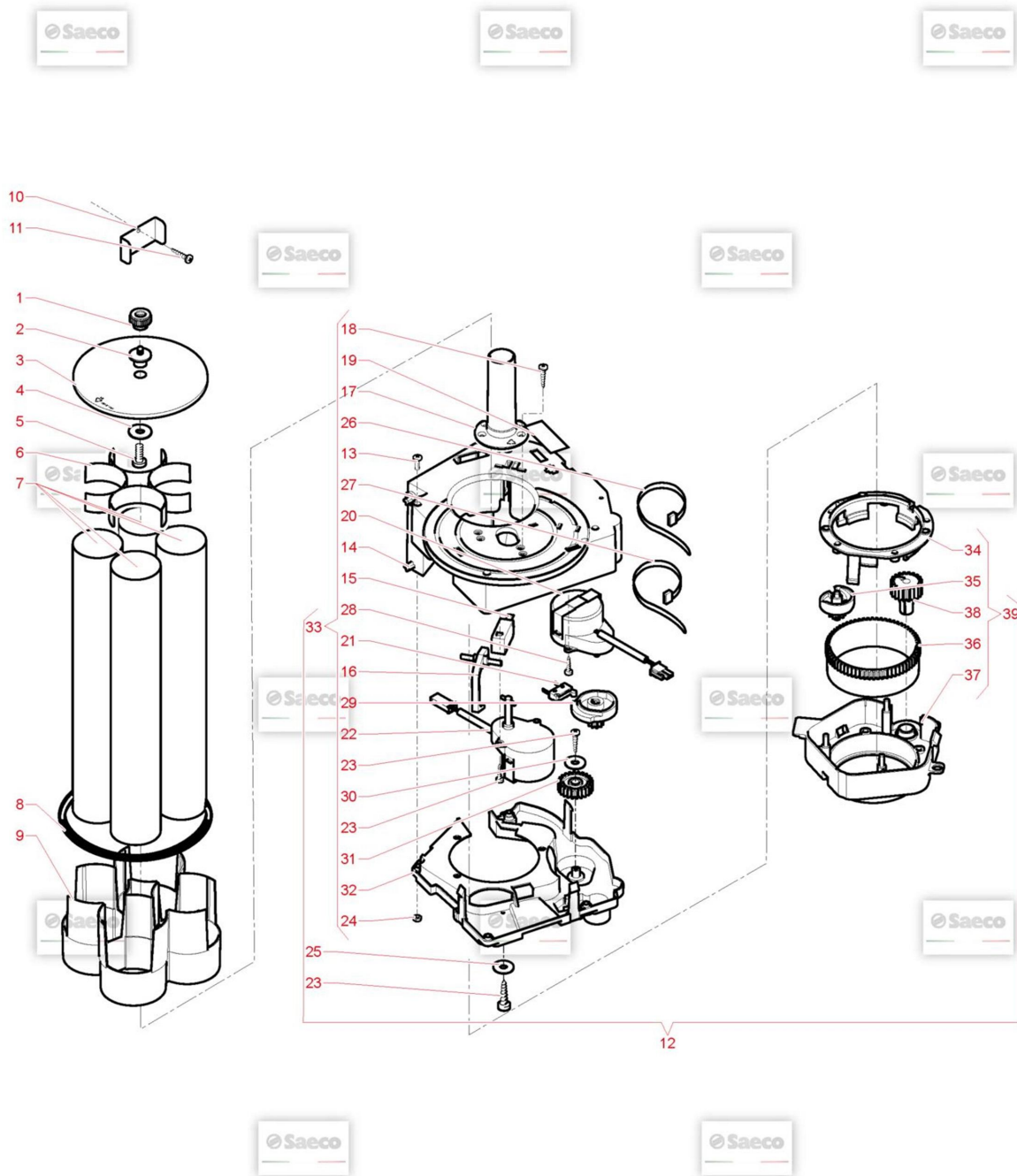

Model Machine

MACSAE114

SAECO CRISTALLO 400 ЧЁРНАЯ

Web Pos. Foto Item - Replace by Description



*Press - CTRL + CLICK go to item in a new window
Натисніть - Ctrl + права кнопка миші щоб відкрити запчастину в новому вікні*



1



12002034

KNOB WITH BUSH M5
KNOB WITH BUSH M5



2



11010585

CENTRAL PIN FOR CUP COLUMN
CENTRAL PIN FOR CUP COLUMN



3



11028032

TANK LID GLASSES
TANK LID GLASSES



4

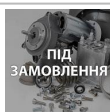

U207.009

PLAIN WASHER 5,5X15 UNI 6593 GA
PLAIN WASHER 5,5X15 UNI 6593 GA



5



U043.021

SCREW TCBC M5,0X8 UNI 7687 GALV.
VITE TCBC M5,0X8 UNI 7687 ZNP



6



11005072

CUP TUBE FIXING SPRING
CUP TUBE FIXING SPRING



7



1863.054

CUP TUBE
TUBO BICCHIERI



8



NM02.002

OR 4412 EPDM
OR 4412 EPDM



9



11000976

TANK DRINKS
SERBATOIO BICCHIERI UNIFICATO



10

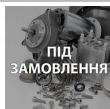

1813.162

BRACKET STOP DISPENCER
BRACKET STOP DISPENCER



11



U110.004

SCREW AUT.TCB 3,5X6,5 DIN 7981F
VITE AUT.TCB 3,5X6,5 DIN 7981 F NIK



12

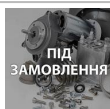

11004750

ASS. CUP DISPENSER 120V D.73
ASS. CUP DISPENSER 120V D.73



12

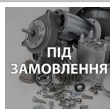











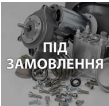















11009152

CRISTALLO400 ASSEMBLED DISPENSER D.73
CRISTALLO400 ASSEMBLED DISPENSER D.73

Model Machine

MACSAE114

















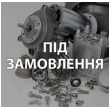

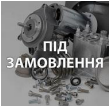





SAECO CRISTALLO 400 ЧЁРНАЯ

	12		9110.140.A2A	CUP DISTRIBUTOR <i>ASS.DISTRIBUTORE BICCHIERI FS400</i>
	13		U034.001	SCREW TCI M3,0X30 UNI 6107 GALV. <i>VITE TCI M3,0X30 UNI 6107 ZNP</i>
	14		11000785	ВЕРХНІЙ КОРПУС БЛОКУ ВИДАЧІ СТАКАНІВ <i>CORPO SUPERIORE DISTRIBUTORE BICCHIERI</i>
	14		11000868	CASING UPPER CUP DISTRIBUTOR UL <i>CASING UPPER CUP DISTRIBUTOR UL</i>
	15		NE05.065	MICROSWITCH CHERRY D41R-QGAD_61 <i>MICROINTERRUTTORE CHERRY D419Q1A ATLANTE CRISTALLO NEXTAGE</i>
	16		1813.067.A20	LEVER <i>LEVA PRESENZA BICCHIERI</i>
	17		11000642	TUBE FOR BASKET GLASSES <i>CANOTTO PER CESTELLO BICCHIERI</i>
	18		U142.008	PANELVIT TSP 3,5X12 DIN 7505 AGAL <i>PANELVIT TSP 3,5X12 DIN 7505 A GAL</i>
	19		11001467	ADHESIVE LABEL PVC 54X30 MM <i>ADHESIVE LABEL PVC 54X30 MM</i>
	20		9121.226.00A	MOTOR SAIA UDS 5 RPM 220V <i>MOTORE SAIA UDS 5 RPM 220V</i>
	20		9121.226.00F	RATIOMOTOR SAIA UDS 5RPM 120V60HZ <i>RATIOMOTOR SAIA UDS 5RPM 120V 60HZ</i>
	21		NE05.064	MICROSWITCH SAIA V4NC <i>MICROINTERRUTTORE SAIA V4NC</i>
	22		11000391	MOTOR SAIA UDS1ND5M75CAN2WZ239 <i>MOTORE SAIA UDS1ND5M75CAN2WZ239</i>
	22		11000481	MOTOR SAIA CUP DISPENSER D6 PIVOT 120V <i>MOTOR SAIA CUP DISPENSER D6 PIVOT 120V</i>

Model Machine

MACSAE114











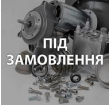

SAECO CRISTALLO 400 ЧЁРНАЯ

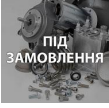
	23		U116.005	SCREW AUT.PT TCB 3,0X8 WN 1441 VITE AUT.PT TCB 3,0X8 WN 1441 ZNP
	24		U324.005	NUT M3 FLANGED INDENTED BASE DADO M3 FLANGIATO BASE DENTELLATA
	25		U212.006	WASHER 3,2X11X0,5 ZNP WASHER 3,2X11X0,5 ZNP
	26	 ПІД ЗАМОВЛЕННЯ	NF11.002	SELF LOCK STRIP W=2.5 L=98 SELF LOCK STRIP W=2.5 L=98
	27	 ПІД ЗАМОВЛЕННЯ	144320200	SELF LOCK STRIP W=2.6 L=200 SELF LOCK STRIP W=2.6 L=200
	28		U109.005	SCREW AUT.TCB 3,5X16 DIN 7981C VITE AUT.TCB 3,5X16 DIN 798
	29		1863.066.A20	DISENGAGE CAM GLASSES DISENGAGE CAM GLASSES
	30		U201.001	PLAIN WASHER 3,2X9 DIN 7349 GALV. PLAIN WASHER 3,2X9 DIN 7349 GALV.
	31	 ПІД ЗАМОВЛЕННЯ	1813.068.A20	TOOTHED WHEEL TOOTHED WHEEL
	32	 ПІД ЗАМОВЛЕННЯ	1813.062.A20	LOWER CASING DISPENSER GLASSES LOWER CASING DISPENSER GLASSES
	32	 ПІД ЗАМОВЛЕННЯ	1813.308.050	LOVER CASING DISPENSER GLASSESUL LOVER CASING DISPENSER GLASSES UL
	33	 ПІД ЗАМОВЛЕННЯ	11003955	FS400 UL ASSEMBL.CUP DISP. GROUP FS400 UL ASSEMBL.CUP DISP. GROUP
	33	 ПІД ЗАМОВЛЕННЯ	9110.151.A2A	DISPENSER ASS. DISPENSER ASS.

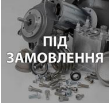
Model Machine

MACSAE114

SAECO CRISTALLO 400 ЧЁРНАЯ

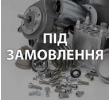
	34	 ПІД ЗАМОВЛЕННЯ	11000786	RETAINING RING <i>RETAINING RING</i>
	35		1813.072.A20	SNAIL FOR GLASSES D.70 <i>CHIOCCIOLA X BICCHIERI</i>
	36	 ПІД ЗАМОВЛЕННЯ	1813.073.A20	TOOTHED WHEEL FOR SNAIL <i>TOOTHED WHEEL FOR SNAIL</i>
	37	 ПІД ЗАМОВЛЕННЯ	11000833	SNAIL SUPPORT <i>SNAIL SUPPORT</i>
	38		1813.074.A20	TOOTHED WHEEL <i>TOOTHED WHEEL</i>
	39		11000835	ASS.SNAIL SUPPORT <i>ASS.SNAIL SUPPORT</i>
	39	 ПІД ЗАМОВЛЕННЯ	11000863	ASSEMBLY SUPPORT <i>ASSEMBLY SUPPORT</i>

Model Machine

MACSAE114

SAECO CRISTALLO 400 ЧЁРНАЯ

MACSAE114.T.0009

TAVOLA NR. 9 - ARTICOLO SAECO CRISTALLO 400 ЧЁРНАЯ

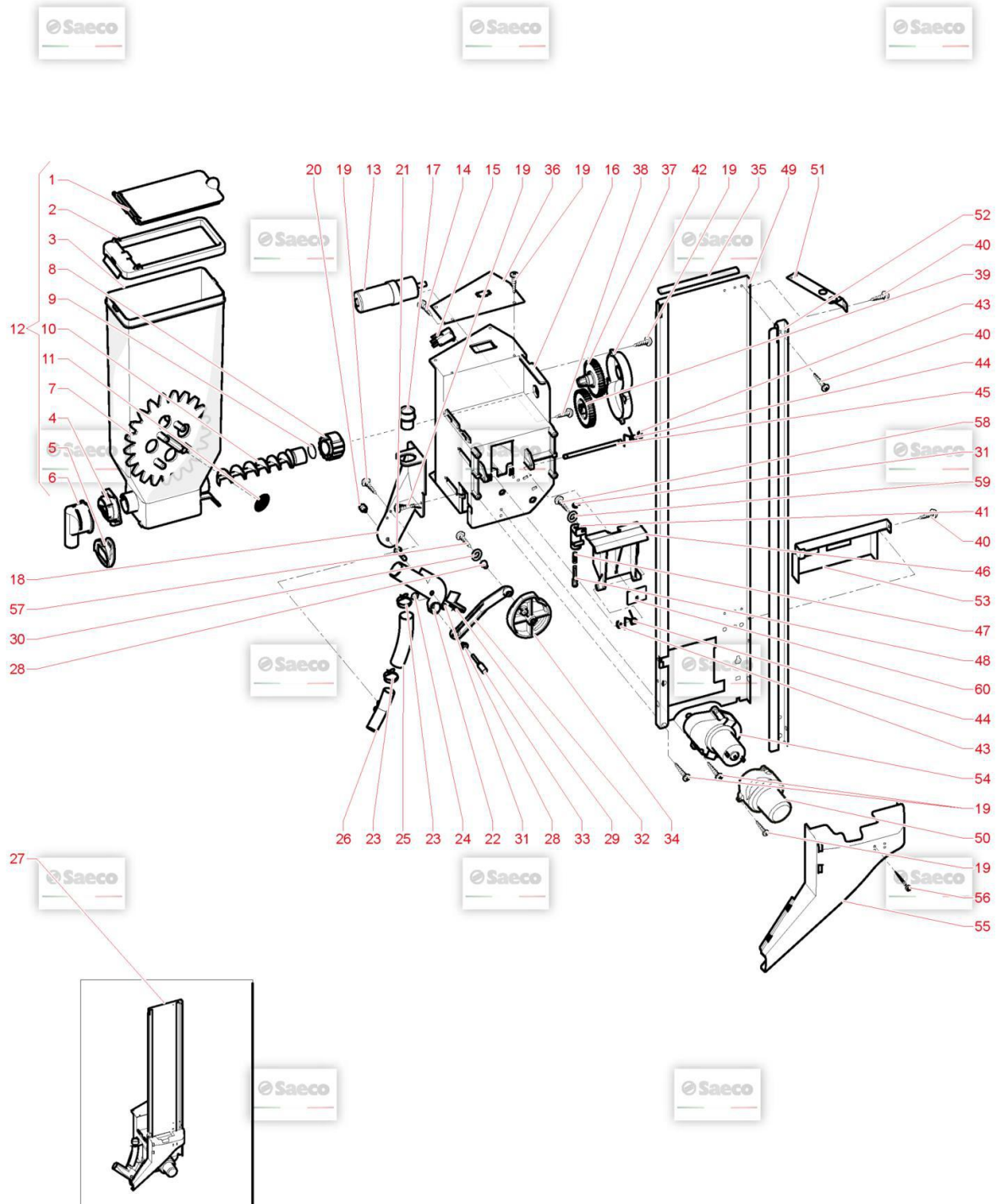

Model Machine

MACSAE114

SAECO CRISTALLO 400 ЧЁРНАЯ

Web Pos. Foto Item - Replace by Description



Press - CTRL + CLICK go to item in a new window
Натисніть - Ctrl + права кнопка миші щоб відкрити запчастину в новому вікні



1



9111.683

SOLUBLE COVER
COPERCHIETTO SOLUBILI



2



9111.696

COVER SUGAR CONTAINER
COPERCHIO CONTENITORE ZUCCHERO



3



9111.685

SUGAR CONTAINER
CONTENITORE ZUCCHERO



4



9111.630.060

BUSH FOR POWDERS TANK
BOCCOLA X SERBAT.POLVERI C/AGGANCI



5



9111.338.270

BULKHEAD FOR APERT. CLOSURE ORANGE
PARATIA CHIUSURA BOCCHETTA ARANCIO



6



9111.629.060

APERTURE FOR SOLUBLES HOPPER
APERTURE FOR SOLUBLES HOPPER



7



11032878

ШЕСТЕРНЯ КОНТЕЙНЕРА ДЛЯ ЦУКРУ (EX 9111.725)
CONTAINER WHEEL SUGAR BPA FREE



8



11012130

BACK BUSH REINFORCE
BACK BUSH REINFORCE



9



NM03.013

OR 2,3X15 NBR
OR 2,3X15 NBR



10



9111.726

SCROLL SCREW SUGAR CONTAINER
COCLEA CONTENITORE ZUCCHERO



11



9111.646

ADHESIVE FOR TANK
ADHESIVE FOR TANK



12



9110.137

КОНТЕЙНЕР ДЛЯ ЦУКРУ SAECO
ASS. CONTENITORE ZUCCHERO



13













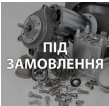















9121.106.00P

SUGAR RATIOMOTOR 24V DC
MOTORIDUTTORE ZUCCHERO 24V D.C.

Model Machine

MACSAE114



























SAECO CRISTALLO 400 ЧЁРНАЯ

	14	 ПІД ЗАМОВЛЕННЯ	U110.007	SCREW AUT.TCB 2,9X16 DIN 7981F ZNP <i>SCREW AUT.TCB 2,9X16 DIN 7981 F ZNP</i>
	15		NE05.002	МІКРОВИМИКАЧ ДЛЯ КАВОМАШИНИ EF83161.8 <i>MICROINTERRUTTORE</i>
	16		11033196	СУПОРТ МЕХАНІЗМА МЕШАЛКИ САХАРА <i>SUPP.PALETTIERA</i>
	16	 ПІД ЗАМОВЛЕННЯ	9111.684.A20	SUPPORT STIRRER <i>SUPPORTO PALETTIERA</i>
	17		9111.699	ПЕРЕХОДНИК-ДЕРЖАТЕЛЬ ДЛЯ ТРУБКИ ВЫДАЧИ САХАРА КОФЕМАШИ... <i>BOCCHETTA TUBO ZUCCHERO</i>
	18		9111.686.A20	SUPPORT SUGAR CONVEYER <i>SUPPORTO BASCULINA ZUCCHERO</i>
	19		U116.006	SCREW AUT.PT TCB 3,5X12 WN 1441 ZNP <i>VITE AUT.PT TCB 3,5X12 WN 1441 ZNP</i>
	20		11000388	KNOB M3 SUGAR CONVEYER <i>POMELLO M 3 BASCULINA ZUCCHERO</i>
	21		11000389	GRAINED PIVOT SUGAR COVEYER <i>PERNO ZIGRINATO BASCULINA ZUCCHERO</i>
	22		9111.690	SUGAR CONVEYER <i>BASCULINA ZUCCHERO</i>
	23	 ПІД ЗАМОВЛЕННЯ	9111.553	SELF-ENERGIZING SPRING FOR TUBE D.2 <i>SELF-ENERGIZING SPRING FOR TUBE D.2</i>
	24		123160302	NUT M3 HIGH UNI 5587 GALVANIZED <i>NUT M3 HIGH UNI 5587 GALVANIZED</i>
	25		9111.700	SUGAR TUBE <i>TUBO ZUCCHERO</i>
	26		9111.697	CONNECTOR SUGAR TUBE <i>RACCORDO TUBO ZUCCHERO</i>

Model Machine

MACSAE114





























SAECO CRISTALLO 400 ЧЁРНАЯ

	27		11013180	ASSEMBLY SUGAR/SPOONS DISPENDER 120V UL <i>ASSEMBLY SUGAR/SPOONS DISPENDER 120V UL</i>
	27		11033213	DISPENCER STIRRER /SUGAR 25RPM <i>DISPENCER STIRRER /SUGAR 25RPM</i>
	27		9110.138	DISTRIB.ASS. STIRRER /SUGAR <i>ASS.DISTRIB.PALETTE/ZUCCHERO</i>
	28		9111.705	SPHERICAL PIN <i>PERNO SFERICO</i>
	29		9111.727	BULKHEAD SUGAR CONVEYER <i>PARATIA BASCULINA ZUCCHERO</i>
	30		U201.001	PLAIN WASHER 3,2X9 DIN 7349 GALV. <i>PLAIN WASHER 3,2X9 DIN 7349 GALV.</i>
	31		U701.011	STEEL SNAP RING 5 UNI 7434 <i>ANELLO ELASTICO 5 UNI 7434</i>
	32		9111.691	CONNECTING ROD SUGAR DISPENCER <i>BIELLA DISTRIBUTORE ZUCCHERO</i>
	33		11004295	KNOB FOR SUGAR CONNECTING RODPIPE <i>POMELLO BLOCCAGGIO BIELLA TUBO ZUCCH.</i>
	34		9111.688.A20	CAM SUGAR DISPENCER <i>CAMMA DISTRIBUTORE ZUCCHERO</i>
	35		9111.668	STIRRER DISP.COUNTERWEIGHT D.10 <i>CONTRAPPESO PALETTE D.10</i>
	35		9111.669	STIRRER DISP.COUNTERWEIGHT D.10 <i>STIRRER DISP.COUNTERWEIGHT D.10</i>
	35		9111.745	STIRRER DISP.COUNTERWEIGHT <i>CONTRAPPESO PALETTE L=113MM</i>

Model Machine

MACSAE114









SAECO CRISTALLO 400 ЧЁРНАЯ

	36		9111.707	REINFORCING PLATE <i>PIASTRA RINFORZO PALETTIERA</i>
	37		9111.694	JOINT WITH GEAR <i>GIUNTO CON INGRANAGGIO</i>
	38		U116.005	SCREW AUT.PT TCB 3,0X8 WN 1441 <i>VITE AUT.PT TCB 3,0X8 WN 1441 ZNP</i>
	39		9111.695	GEAR Z40 <i>INGRANAGGIO Z 40</i>
	40		U110.004	SCREW AUT.TCB 3,5X6,5 DIN 7981F <i>VITE AUT.TCB 3,5X6,5 DIN 7981 F NIK</i>
	41		9111.737	ОПОРА ТРУБКА ПЛАСТИКОВАЯ <i>SUPPORT</i>
	42		9111.687.A20	GEAR COVER <i>COPERCHIO INGRANAGGI</i>
	43		U701.006	ФІКСУЮЧА СКОБА 3,2 (ЗАЛІЗО) SAECO <i>ANELLO ELASTICO 3,2</i>
	44		9111.730	SPRING <i>MOLLA ESPULSORE PALETTE</i>
	45		9111.376	PIN FOR STIRRER EXPELLER <i>PIN FOR STIRRER EXPELLER</i>
	46		11011240	STIRRER EXPELLER BLACK NEW <i>STIRRER EXPELLER BLACK NEW</i>
	47		11031341	SPRING <i>SPRING</i>
	48		11002209	PIN <i>PIN</i>
	49		11009886	STIRRER GUIDE CRISTALLO400 NEW <i>STIRRER GUIDE CRISTALLO400 NEW</i>

Model Machine

MACSAE114

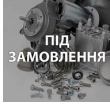
SAECO CRISTALLO 400 ЧЁРНАЯ

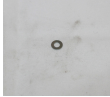
	50		11025411	CRISTALLO SPOON'S MOTOR COVER <i>CRISTALLO SPOON'S MOTOR COVER</i>
	51		9111.706	BRACKET FOR STIRRER GUIDE <i>BRACKET FOR STIRRER GUIDE</i>
	52		9111.693	STIRRER GUIDE <i>STIRRER GUIDE</i>
	53		9111.739	CARTER STIRRER EXPULSION <i>CARTER STIRRER EXPULSION</i>
	54		11025284	MOTORIDUTTORE FIBER 37RPM <i>MOTORIDUTTORE FIBER 37RPM</i>
	54		11033191	GEARMOTOR MECHTEX 25 RPM <i>MOTORIDUTTORE MECHTEX 25 RPM</i>
	54		9121.107.00P	STIRRER RATIOMOTOR FIBER <i>MOTORIDUTTORE PALETTE FIBER</i>
	55		9111.698.A20	STIRRER SLIDE <i>SCIVOLO PALETTE</i>
	56		9161.082	RUBBER COUPLER <i>AGGANCIO IN GOMMA</i>
	57		U116.004	SCREW AUT.PT TCB 3,0X16 WN 1441 <i>SCREW AUT.PT TCB 3,0X16 WN 1441</i>
	58		U117.003	SCREW AUT.PT TCB 2.5X10 WN 1442 <i>SCREW AUT.PT TCB 2.5X10 WN 1442</i>
	59		U207.003	PLAIN WASHER 3,2X7 UNI 6592 GALV. <i>PLAIN WASHER 3,2X7 UNI 6592 GALV.</i>
	60		11025089	PLATE REINFORCEMENT <i>PIASTRINA RINFORZO ESPULSORE</i>

Model Machine

MACSAE114

SAECO CRISTALLO 400 ЧЁРНАЯ

MACSAE114.T.0010

TAVOLA NR. 10 - ARTICOLO SAECO CRISTALLO 400 ЧЁРНАЯ

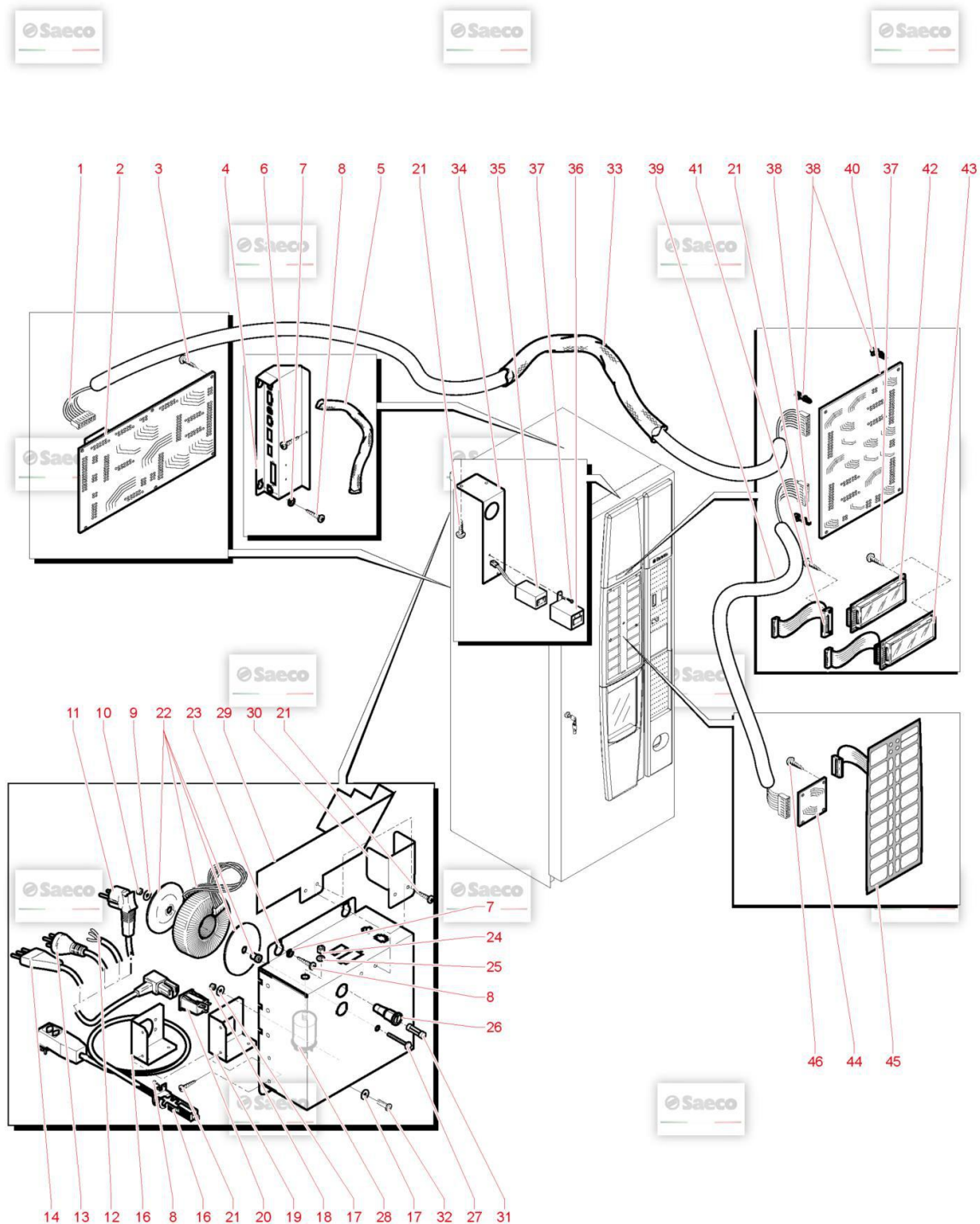

Model Machine

MACSAE114

SAECO CRISTALLO 400 ЧЁРНАЯ

Web Pos. Foto Item - Replace by Description



Press - CTRL + CLICK go to item in a new window

Натисніть - Ctrl + права кнопка миші щоб відкрити запчастину в новому вікні



1

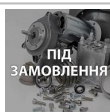

1863.603

FLAT CABLE
FLAT CABLE



2



1863.636

POWER CARD FS400
SCHEDA POWER FS400



3



U116.006

SCREW AUT.PT TCB 3,5X12 WN 1441 ZNP
VITE AUT.PT TCB 3,5X12 WN 1441 ZNP



4

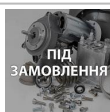

1863.070

BOX
BOX



5



11001619

CABLE TUBE L.520 MM
GUAINA X CAVI L.520 MM



6



U109.003

SCREW TCB 3,5X9,5 DIN 7981 C NICK
SCREW TCB 3,5X9,5 DIN 7981 C NICK



7

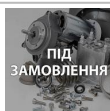

11011054

PIN FOR BOSS D.8
PIN FOR BOSS D.8



8



U110.005

SCREW AUT.TCB 3,9X9,5 DIN 7981F
VITE AUT.TCB 3,9X9,5 DIN 798



9

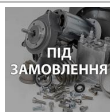

U207.013

PLAIN WASHER 6.5X18 UNI 6592 GALV
PLAIN WASHER 6.5X18 UNI 6592 GALV



10



U310.004

NUT SELF LOCK.M6 UNI 7473
NUT SELF LOCK.M6 UNI 7473



11



NE01.050

CABLE SCHUKO WITH PLUG EN60320C1
CAVO SCHUKO CON SPINA EN60320 C13



12

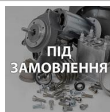

NE01.054

CABLE WITH PLUG EN60320 C13
CABLE WITH PLUG EN60320 C13



13

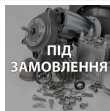











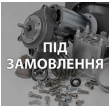

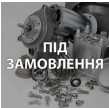













NE01.053

CABLE AUSTRAL. +PLUG EN60320 C13
CABLE AUSTRAL. +PLUG EN60320 C13

Model Machine

MACSAE114























SAECO CRISTALLO 400 ЧЁРНАЯ

	13		NE01.093	CABLE ARGENTINA + PLUG EN60320C13 <i>CABLE ARGENTINA + PLUG EN60320 C13</i>
	14		17800019	BLACK POWER CABLE BRAZIL L=1200 <i>BLACK POWER CABLE BRAZIL L=1200</i>
	14		NE01.051	CABLE SWITZERLAND WITH PLUG EN603 <i>CABLE SWITZERLAND WITH PLUG EN603</i>
	15		11003906	USA CABLE SUPPORT ELECTRONIC PARTS BOX <i>USA CABLE SUPPORT ELECTRONIC PARTS BOX</i>
	16		11008469	POWER CABLE USA 3 POLE 15A <i>POWER CABLE USA 3 POLE 15A</i>
	17		U208.003	TOOTHED WASHER 5,1X9 BRU <i>TOOTHED WASHER 5,1X9 BRU</i>
	18		U302.003	МЕТАЛЕВА ГАЙКА M4 UNI 5588 ZNP <i>DADO ESAGONALE M4 UNI 5588 ZNP</i>
	19		11000546	POWER CONNECTOR SUPPORT <i>SQUADRETTA X PRESA VASCHETTA</i>
	20		187850400	TRIPOLE SOCKET SELF-LOCKING <i>TRIPOLE SOCKET SELF-LOCKING</i>
	21		U110.003	SCREW AUT.TCB 3,5X9,5 DIN 7981F <i>VITE AUT.TCB 3,5X9,5 DIN 798</i>
	22		NE19.023	TOROIDAL TRANSFORMER COMBI 240V <i>TOROIDAL TRANSFORMER COMBI 240V</i>
	22		NE19.028	TOROIDAL TRANSFORMER FS 400 <i>TRASFORMATORE TOROIDALE FS 400</i>
	23		1863.045	ASPIRATION CASING FOR MIXER <i>ASPIRATION CASING FOR MIXER</i>
	24		U302.007	NUT HEXAGONAL M8 UNI 5588 <i>NUT HEXAGONAL M8 UNI 5588</i>

Model Machine

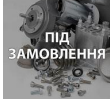
MACSAE114

SAECO CRISTALLO 400 ЧЁРНАЯ

	25		U208.009	TOOTHED WASHER 8,4X15 UNI 3703 <i>TOOTHED WASHER 8,4X15 UNI 3703</i>
	26		NE13.016	FUSE HOLDER WITH SCREW ON CAP <i>PORTAFUSIBILE CON TAPPO A VITE</i>
	27	 ПІД ЗАМОВЛЕННЯ	U005.013	SCREW TE M6,0X70 UNI 5739 GALV. <i>SCREW TE M6,0X70 UNI 5739 GALV.</i>
	28		12001353	МЕРЕЖЕВИЙ ФІЛЬТР 16А <i>LOCKING SCREW ANTIDISTURB FILTER 16A</i>
	29	 ПІД ЗАМОВЛЕННЯ	11008600	HARNESS UL CARTER CRISTALLO400 <i>HARNESS UL CARTER CRISTALLO400</i>
	30	 ПІД ЗАМОВЛЕННЯ	11003867	SAFETY PLATE FOR EL.BOX CONNECTOR <i>SAFETY PLATE FOR EL.BOX CONNECTOR</i>
	31	 ПІД ЗАМОВЛЕННЯ	NE13.002	FUSE 6,3X32 8A 250V DELAYED <i>FUSE 6,3X32 8A 250V DELAYED</i>
	31	 ПІД ЗАМОВЛЕННЯ	NE13.081	FUSE 6,3X32 16A 250V DELAYED UL <i>FUSIBILE 6,3 X 32 15A 250V RITARD UL SOLO UL</i>
	32		12002039	SCREW TCBD TORX 20 M4X12 ZN-B <i>VITE TCBD TORX 20 M4X12 ZN-B</i>
	33		11003521	620MM CABLE TUBE <i>GUAINA X CAVI L.780MM</i>
	34	 ПІД ЗАМОВЛЕННЯ	1863.027	PIASTRINA CONTAIMPULSI <i>PIASTRINA CONTAIMPULSI</i>
	35		NE13.025.00P	IMPULSE COUNTER KEISU GX-06R 24V <i>CONTAIMPULSI KEISU GX-06R 24</i>
	36		9991.140.050	IMPULSE COUNTER HOLDER KEISU GX-06R <i>PORTA CONTAIMPULSI KEISU GX-</i>

Model Machine

MACSAE114

SAECO CRISTALLO 400 ЧЁРНАЯ



37



U116.005

SCREW AUT.PT TCB 3,0X8 WN 1441
VITE AUT.PT TCB 3,0X8 WN 1441 ZNP



38



9111.402

SPACER FOR CARD
SPACER FOR CARD



39



0875.650

FLAT CONNECTOR TOUCH PANEL/CPU
FLAT COLLEGAM. TASTIERA/CPU



40

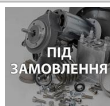

11022282

CPU+SW AS.CRISTALLO400 HS2
CPU+SW AS.CRISTALLO400 HS2



40

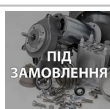

11023404

CPU+SW AS. CRISTALLO400 ESPRESSO
CPU+SW AS. CRISTALLO400 ESPRESSO



40



11026055

CPU+SW AS CRISTALLO400/600 ESP/TTT
CPU+SW AS CRISTALLO400/600 ESP/TTT



41

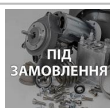

11021700

FLAT CABLE 16 POLES L.300MM
FLAT CABLE 16 POLES L.300MM



41



1863.631

FLAT CABLE
FLAT CABLE DISPLAY



42



11000299

DISPLAY FS400 GREY
DISPLAY FS400 GRIGIO



43



192200500

20X2 LCD BLUE DISPLAY STN + FLAT
20X2 LCD BLUE DISPLAY STN + FLAT



44



0875.651

TOUCH PANEL CONNECTION CARD
SCHEDINO COLLEGAMENTO TASTIE



45



11001850

RED MEMBRANE KEYBOARD
TASTIERA A MEMBRANA FS400 ROSSA



45



11014247

SWITCH PUSHBUTTON GREY
TASTIERA GRIGIA



45



11030948

SWITCH PUSHBUTTON GREY
TASTIERA ADES.MEMBR.CRISTALLO600 C.B.GRY

Model Machine

MACSAE114

SAECO CRISTALLO 400 ЧЁРНАЯ



46



U110.004

SCREW AUT.TCB 3,5X6,5 DIN 7981F

VITE AUT.TCB 3,5X6,5 DIN 7981 F NIK

Model Machine

MACSAE114

SAECO CRISTALLO 400 ЧЁРНАЯ

MACSAE114.T.0011



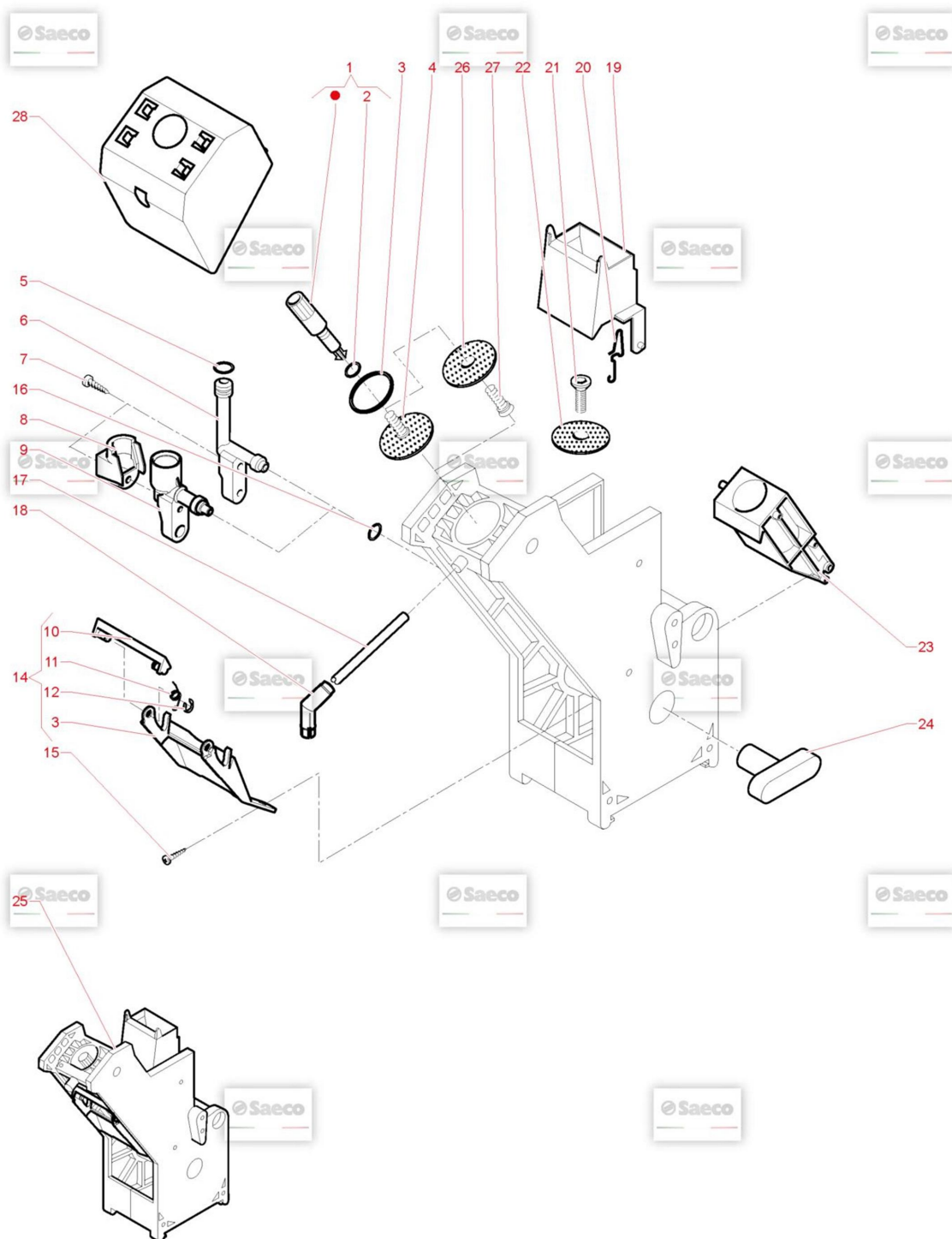

























TAVOLA NR. 11 - ARTICOLO SAECO CRISTALLO 400 ЧЁРНАЯ



Model Machine

MACSAE114

























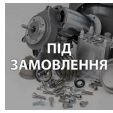

SAECO CRISTALLO 400 ЧЁРНАЯ

Web	Pos.	Foto	Item - Replace by	Description
				<i>Press - CTRL + CLICK go to item in a new window Натисніть - Ctrl + права кнопка миші щоб відкрити запчастину в новому вікні</i>
	1		9169.A14.060	ТРИМАЧ ФІЛЬТРА-СИТО РОБОЧОГО БЛОКУ КОРИЧНЕВИЙ КАВОМАШИН... <i>PIN FOR PERCOLATOR BROWN</i>
	2		NM02.006	OR R5 TERMOIL <i>OR R5 EPDM</i>
	3		140322061	O-RING 4112 EPDM <i>OR 4112 IN EPDM</i>
	4		324000100	SS PERCOLATOR D=34 SCREW FOR UNIT <i>SS PERCOLATOR D=34 SCREW FOR UNIT</i>
	5	 	140320461	OR ORM 0080-20 TERMOIL <i>OR ORM 0080-20 IN TERMOIL</i>
	6	 	322000501	WATERFLOW PISTON BROWN <i>WATERFLOW PISTON BROWN</i>
	7		129512921	SCREW TCB TORX 10 AB 2,9X13 SHEET SS <i>SCREW TCB TORX 10 2,9X13 SHEET SS</i>
	8		11010013	CARTER FOR MUFF PREHEATING UNIT <i>CARTE X MANICOTTO GRUPPO PRERISCALDO</i>
	9		11005371	UNIT COFFEE MUFF <i>MANICOTTO GRUPPO CAFFE' UNIT COFFEE MUFF</i>
	10		9111.537.060	BROWN SCRAPER COFFEE GROUP <i>BROWN SCRAPER COFFEE GROUP</i>
	11		9111.520	SPRING FOR SCRAPER SECTION 0.6 <i>SPRING FOR SCRAPER SECTION 0.6</i>
	12		U701.006	ФІКСУЮЧА СКОБА 3,2 (ЗАЛІЗО) SAECO <i>ANELLO ELASTICO 3,2</i>
	13		9111.539.060	FORK FOR SCRAPER <i>FORCELLA PER RASCHIATORE</i>

Model Machine

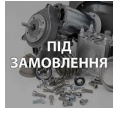
MACSAE114

SAECO CRISTALLO 400 ЧЁРНАЯ

	14		9110.067.060	SCRAPER ASS.FOR CAPPUCINAT. TUBE ASS.RASCHIATORE X SG500/700
	15		U110.013	БОЛТ МЕТАЛЕВИЙ 3,9X6,5 DIN 7981 F SCREW AUT.TCB 3,9X6,5 DIN 7981 F
	16		140321462	O-RING 2018 SILICONE OR 2018 IN SILICONE
	17		9972.057	КОРИЧНЕВА ГУМОВА ТРУБКА 5X8 2 МЕТРИ TUBO SILICONE MARRON 5X8 L.2000 MM
	18		9111.349	ELBOW DISPENSING NOZZLE UGELLO EROGAZIONE GOMITO
	19		322001201	MOBILE SCRAPER BROWN NARROW MOBILE SCRAPER BROWN NARROW
	20		9161.425	SPRING FOR SCRAPER SPRING FOR SCRAPER
	21		129851921	TSP SCREW M3X6 UNI 7688 SS TSP SCREW M3X6 UNI 7688 SS
	22		324000200	SS PERCOLATOR D=34 FOR UNIT SS PERCOLATOR D=34 FOR UNIT
	23		222711101	BROWN GROUND COFF.CONTAINER D=36 ASSY. BROWN GROUND COFF.CONTAINER D=36 ASSY.
	24		9161.021.060	KEY FOR BREW UNIT BROWN CHIAVE X GRUPPO CAFFE' MARRO
	25		11005421	BREW UNIT 7 GRAMS CRISTALLO600 GRUPPO CAFFE' 7GR CRISTALLO600
	25		11023330	ЗАВАРОЧНЫЙ БЛОК (7GR) ДЛЯ КОФЕМАШИНЫ PHILIPS SAECO BREW UNIT 7 GRAMS CRISTALLO600
	25		9160.078.060	BROWN BREW UNIT DA 10P 7 GRAMS GRUPPO CAFFE' C/RASCHIATORE

Model Machine

MACSAE114

SAECO CRISTALLO 400 ЧЁРНАЯ



26



11012630

PERCOLATOR D.34
PERCOLATOR D.34



27



129852821

TSP SCREW M3X14 UNI 7688 SS
TSP SCREW M3X14 UNI 7688 SS



28



11013053

CARTER FOR DOSER UNIT
CARTER FOR DOSER UNIT

Model Machine

MACSAE114

SAECO CRISTALLO 400 ЧЁРНАЯ

MACSAE114.T.0012



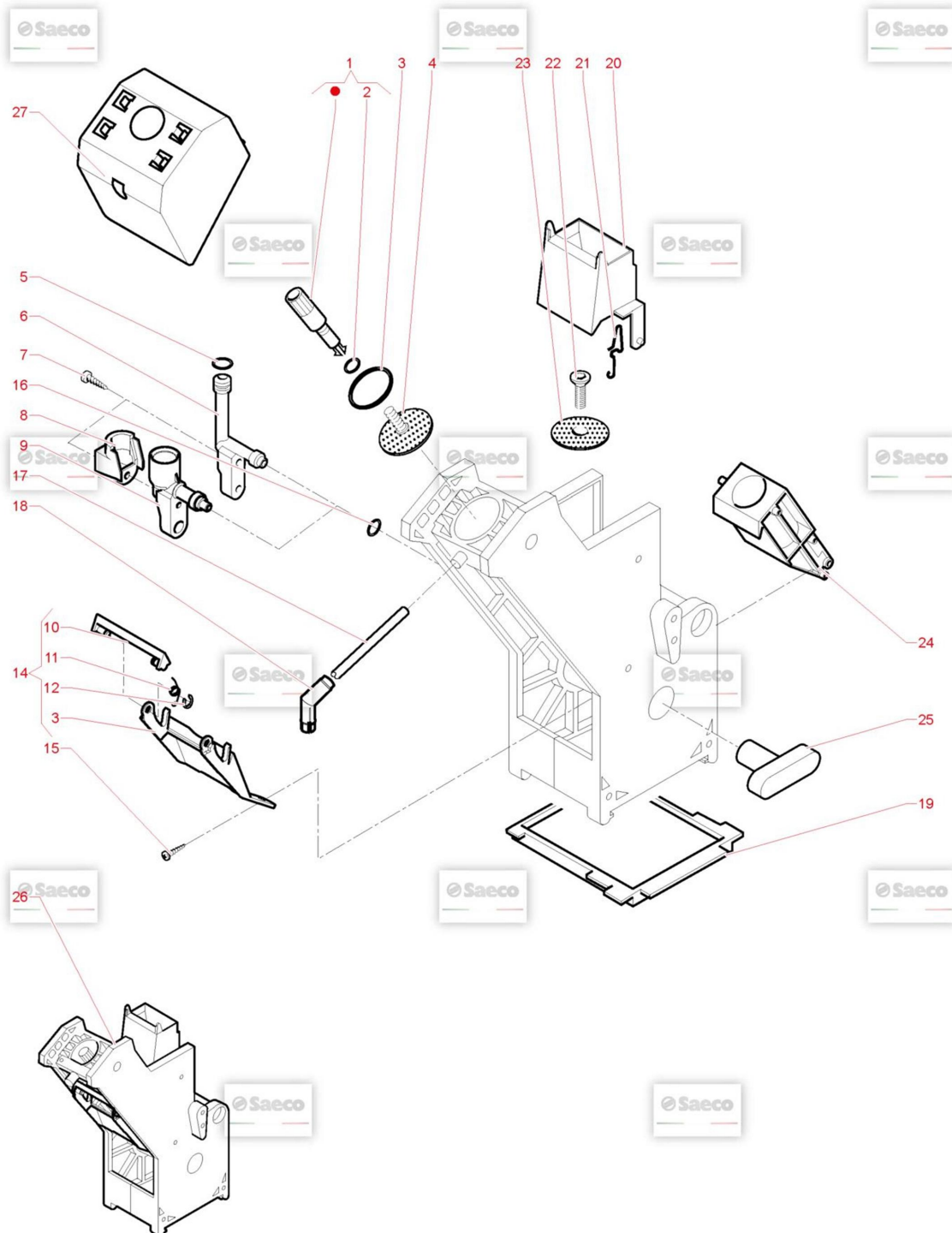























TAVOLA NR. 12 - ARTICOLO SAECO CRISTALLO 400 ЧЁРНАЯ



Model Machine

MACSAE114





























SAECO CRISTALLO 400 ЧЁРНАЯ

Web	Pos.	Foto	Item - Replace by	Description
				<i>Press - CTRL + CLICK go to item in a new window Натисніть - Ctrl + права кнопка миші щоб відкрити запчастину в новому вікні</i>
	1		9169.A14.150	PIN FOR PERCOLATOR GREY ASS.PERNO X DOCCIA COMPLETO GRIGIO
	2		NM02.006	OR R5 TERMOIL OR R5 EPDM
	3		NM01.044	OR ORM 0320-40 SILICONE PTFE/FDA OR ORM 0320-40 SILICONE PTFE
	4		9161.036	UPPER PERCOLATOR FOR UNIT DOCCIA SUPERIORE X GRUPPO
	5		140320461	OR ORM 0080-20 TERMOIL OR ORM 0080-20 IN TERMOIL
	6		322000559	WATER FLOW PISTON GREY WATER FLOW PISTON GREY
	7		129512921	SCREW TCB TORX 10 AB 2,9X13 SHEET SS SCREW TCB TORX 10 2,9X13 SHEET SS
	8		11010013	CARTER FOR MUFF PREHEATING UNIT CARTE X MANICOTTO GRUPPO PRERISCALDO
	9		11005371	UNIT COFFEE MUFF MANICOTTO GRUPPO CAFFE' UNIT COFFEE MUFF
	10		9111.537.150	GREY SCRAPER COFFEE GROUP GREY SCRAPER COFFEE GROUP
	11		9111.520	SPRING FOR SCRAPER SECTION 0.6 SPRING FOR SCRAPER SECTION 0.6
	12		U701.006	ФІКСУЮЧА СКОБА 3,2 (ЗАЛІЗО) SAECO ANELLO ELASTICO 3,2
	13		9111.539.150	FORK FOR SCRAPER FORCELLA PER RASCHIATORE

Model Machine

MACSAE114

SAECO CRISTALLO 400 ЧЁРНАЯ

	14		9110.067.150	SCRAPER ASS.FOR CAPPUCINAT. TUBE ASS.RASCHIATORE X SG500/700
	15		U110.013	БОЛТ МЕТАЛЕВИЙ 3,9X6,5 DIN 7981 F SCREW AUT.TCB 3,9X6,5 DIN 7981 F
	16		140321462	O-RING 2018 SILICONE OR 2018 IN SILICONE
	17		9972.057	КОРИЧНЕВА ГУМОВА ТРУБКА 5X8 2 МЕТРИ TUBO SILICONE MARRON 5X8 L.2000 MM
	18		9111.349	ELBOW DISPENSING NOZZLE UGELLO EROGAZIONE GOMITO
	19		9161.020.060	PLATE FOR COFFEE UNIT BROWN PLATE FOR COFFEE UNIT BROWN
	20		322001259	ПЛАСТИКОВА ВОРНОКА ПОДАЧИ КАВИ (ПЛАСТИК) ЧОРНИЙ MOBILE SCRAPER GREY NARROW
	21		9161.425	SPRING FOR SCRAPER SPRING FOR SCRAPER
	22		129851921	TSP SCREW M3X6 UNI 7688 SS TSP SCREW M3X6 UNI 7688 SS
	23		9161.037	LOWER PERCOLATOR FOR UNIT DOCCIA INFERIORE X GRUPPO
	24		11002626	ASS. COFFEE CONTAINER GREY 9 GR. ASS. COFFEE CONTAINER GREY 9 GR.
	25		9161.021.060	KEY FOR BREW UNIT BROWN CHIAVE X GRUPPO CAFFE' MARRO
	26		11005422	ЗАВАРЮВАЛЬНИЙ БЛОК 9GR SAECO 996530002882 GRUPPO CAFFE' 9GR CRISTALLO 600
	26		9160.079.150	BREW UNIT 9 GRAMS GRUPPO CAFFE' C/RASCHIATORE 9

Model Machine

MACSAE114

SAECO CRISTALLO 400 ЧЁРНАЯ



27



11013053

CARTER FOR DOSER UNIT

CARTER FOR DOSER UNIT

Model Machine

MACSAE114

SAECO CRISTALLO 400 ЧЁРНАЯ

MACSAE114.T.0013



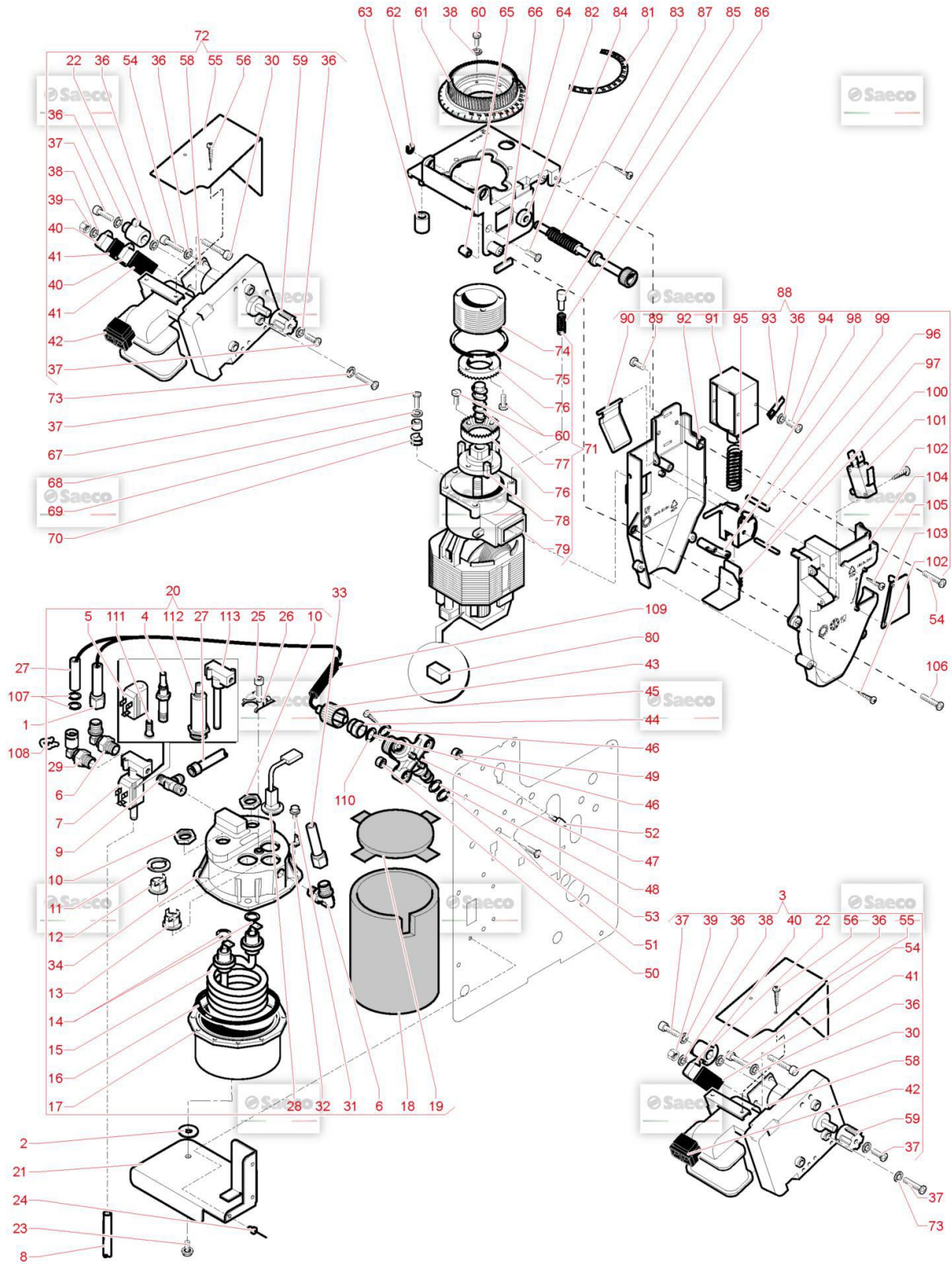









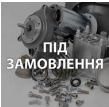













TAVOLA NR. 13 - ARTICOLO SAECO CRISTALLO 400 ЧЁРНАЯ



Model Machine

MACSAE114



















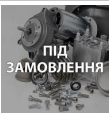



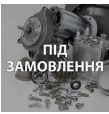



SAECO CRISTALLO 400 ЧЁРНАЯ

Web	Pos.	Foto	Item - Replace by	Description
				<i>Press - CTRL + CLICK go to item in a new window Натисніть - Ctrl + права кнопка миші щоб відкрити запчастину в новому вікні</i>
	1		11025408	TUBE ASSEMBLY TEFLON 3X6 L.290MM <i>TUBE ASSEMBLY TEFLON 3X6 L.290MM</i>
	2		9111.501	INSULATION WASHER <i>INSULATION WASHER</i>
	3		11025216	ASS.RATIOMOTOR FOR DA 230V FS400 <i>ASS.RATIOMOTOR FOR DA 230V FS400</i>
	3		11025217	ASS.RATIOMOTOR FOR DA 220/60 FS400 <i>ASS.RATIOMOTOR FOR DA 220/60 FS400</i>
	3		11025218	ASS.RATIOMOTOR FOR DA 120V FS400 <i>ASS.RATIOMOTOR FOR DA 120V FS400</i>
	4		20007307	SPARE EVT HS1 11023762 <i>SPARE EVT HS1 11023762</i>
	5		20005373	SOLENOID X HS1 11023762 <i>SOLENOID X OLAB 24V DC 6000BH/BODN</i>
	5		20007361	SOLENOID EVT ODE <i>SOLENOID EVT ODE</i>
	6		12001181	BICONICAL CONNECT. L M 1/8X06TEA <i>BICONICAL CONNECT. L M 1/8X06 TEA</i>
	7		11023762	ELECTROVALVE OLAB 3 WAYS 24V DC TEA <i>ELETTROVALVOLA OLAB 3 VIE 24V DC TEA</i>
	7		11032408	ЕЛЕКТРОМАГНІТНИЙ КЛАПАН 3 WAYS 24V <i>ELECTROVALVE ODE 3 WAYS 24V DC</i>
	8		9972.057	КОРИЧНЕВА ГУМОВА ТРУБКА 5X8 2 МЕТРИ <i>TUBO SILICONE MARRON 5X8 L.2000 MM</i>
	9		11011454	"T" CONNECTOR FOR BOILER TEAT"" CONNECTOR FOR BOILER TEA <i>RACCORDO A T X CALDAIA TEA</i>

Model Machine

MACSAE114

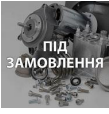





















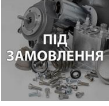

SAECO CRISTALLO 400 ЧЁРНАЯ

	10		9991.029	NUT FOR RESISTOR <i>DADO X RESISTENZA</i>
	11		9991.085	THERMOSTAT FIXING WASHER <i>RONDELLA FERMATERMOSTATI</i>
	12		NE09.021	THERMOSTAT 150°NC FASTON 90° <i>TERMOSTATO 150°NC FASTON 90°</i>
	13		189428700	THERMOSTAT 175° 1NT-15L-5126 <i>THERMOSTAT 175° 1NT-15L-5126</i>
	14	 ПІД ЗАМОВЛЕННЯ	11000972	OR 3050 FKM 80 FD PEROXIDICA <i>OR 3050 FKM 80 FD PEROXIDICA</i>
	15		11007593	RES CALD. V120 W1000 INC.800 <i>RES CALD. V120 W1000 INC.800</i>
	15	 ПІД ЗАМОВЛЕННЯ	9011.255.00A	RES CALD.V230 W1000 <i>RES.CALD. 230V 1000W</i>
	16		NM04.010	OR ORM 0730-40 FPM 70+-5 IRHDBLACK <i>OR ORM 0730-40 FPM 70 +-5 IRHD NERO</i>
	17		9011.226	LOWER OVERSIZE CASING M6 VENDING <i>UPPER OVERSIZE CASING M6 VENDING</i>
	18		11030779	ІЗОЛЯЦІЯ НИЖНЬОЇ ЧАСТИНИ БОЙЛЕРА 600CC <i>COFFEE BOILER 600CC UPPER ISOLATOR</i>
	19		11030777	COFFEE BOILER 600CC UPPER ISOLATOR <i>COFFEE BOILER 600CC UPPER ISOLATOR</i>
	20		11025319	BOILER 230V TEA <i>BOILER ASS. CRISTALLO600 230V</i>
	20	 ПІД ЗАМОВЛЕННЯ	11031131	BOILER CRISTALLO600 C.B. 230V <i>BOILER CRISTALLO600 C.B. 230V</i>
	20	 ПІД ЗАМОВЛЕННЯ	11032545	BOILER PHEDRA ODE 230V <i>BOILER PHEDRA ODE 230V</i>

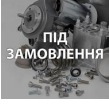
Model Machine

MACSAE114













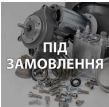













SAECO CRISTALLO 400 ЧЁРНАЯ

	20		11032698	BOILER CRISTALLO ODE 230V <i>BOILER CRISTALLO ODE 230V</i>
	21		11005639	SUPPORT PLATE BOILER <i>SUPPORT PLATE BOILER</i>
	22		9991.037	CAM FOR RATIONMOTOR 1 MICRO <i>CAMMA X MOTORIDUTTORE 1 MICRO</i>
	23		U046.005	SCREW TE M5,0X10 WITH WASHER <i>SCREW TE M5,0X10 WITH WASHER</i>
	24		NF11.115	BLIND RIVETS <i>BLIND RIVETS</i>
	25		12001052	SCREW TCEI M4,0X6 DIN 912 ZIN <i>SCREW TCEI M4,0X6 DIN 912 ZIN</i>
	26		226830200	RETAIN.SPRING 3 THERM. +THERMAL FUSE <i>RETAIN.SPRING 3 THERM. +THERMAL FUSE</i>
	27		11025292	TEFLON TUBE 3X6 L.230 1/8"-1/8 <i>TEFLON TUBE 3X6 L.230 1/8"-1/8</i>
	28		11000090	ASS.SENSOR FS400 <i>ASS.SENSORE X FS400</i>
	28		11003810	SENSOR ASS.CRISTALLO400 120V <i>SENSOR ASS.CRISTALLO400 120V</i>
	29		11029569	CONNECTOR <i>RACC.ORIENT.DADO/OGIV.1/8"CONICO TUBO D4</i>
	30		U034.003	SCREW TCI M3,0X20 UNI 6107 GALV. <i>SCREW TCI M3,0X20 UNI 6107 GALV.</i>
	31		U023.020	SCREW TCEI M6X20 UNI 5931 ZIN <i>VITE TCEI M6X20 UNI 5931 8.8</i>

Model Machine

MACSAE114

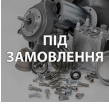



























SAECO CRISTALLO 400 ЧЁРНАЯ

	32		NE15.031	MALE TONGUE PLAIN 6,3 D.6,3 MALE TONGUE PLAIN 6,3 D.6,3
	33	 ПІД ЗАМОВЛЕННЯ	11025297	TEFLON TUBE 3X6 L.310 1/8"-1/8 TEFLON TUBE 3X6 L.310 1/8"-1/8
	34		11002259	UPPER DOSER CASING M6 TEA UPPER DOSER CASING M6 TEA
	35		9991.012.050	CAM FOR RATIOMOTOR BLACK CAMMA X MOTORIDUTTORE NERA
	36		128310404	МЕТАЛЕВЕ УБЧАСТЕ КОЛИЩАТКО UNI 8842 A4 WASHER UNI 8842 A4 BURNISHED
	37		129824002	TCB SCREW M4X10 UNI 7687 ZNP VITE TCB M4X10 UNI 7687 ZNP
	38		U208.002	TOOTHED WASHER 3,3X5,8 UNI 3703 G ROSETTA DENT. 3,3X5,8 UNI 3703 ZNP
	39		U302.002	NUT HEXAGONAL M3 UNI 5588 NUT HEXAGONAL M3 UNI 5588
	40		NE05.066	MICROSWITCH CHERRY D419Q1A МІКРОПЕРЕМИКАЧ РЕДУКТОРА РОБОЧОЇ ГРУПИ
	41		9991.014	CARD FOR MICRO SWITCHES CARTONCINO X MICROINTERRUTTORE
	42		11032817	RATIOMOTOR 30 PACK 230/240-50 RATIOMOTOR 30 PACK 230/240-50
	42	 ПІД ЗАМОВЛЕННЯ	11032818	RATIOMOTOR 30 PACK 120/60 RATIOMOTOR 30 PACK 120/60
	42	 ПІД ЗАМОВЛЕННЯ	11032819	RATIOMOTOR 30 PACK 220/60 MOTORIDUTT.IN PLASTICA PACCO 30 220/60
	43		11005743	KNURLED FEMALE HAND BOLT M14 GODRONE FEMMINA M14

Model Machine

MACSAE114











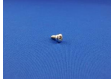





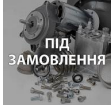





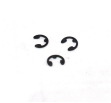

SAECO CRISTALLO 400 ЧЁРНАЯ

	43		11029574	ГАЙКА ДЛЯ РУЧНОГО ЗАЖИМУ M14 ДЛЯ ТРУБКИ 4X2 <i>GODRONE FEMMINA M14 X TUBO 4X2</i>
	44		11005741	CONNECTOR D.6 <i>BOCCOLA ESTERNA D.6</i>
	45		U109.037	SCREW AUT.TCB 4,8X13 DIN 7981C <i>VITE AUT.TCB 4,8X13 DIN 7981 C NIK</i>
	46		140321462	O-RING 2018 SILICONE <i>OR 2018 IN SILICONE</i>
	47		11005370	PIN FOR MUFF <i>PERNO X MANICOTTO PIN FOR MUFF</i>
	48		11013173	OR ORM 0090-20 FKM 80 FD GREENPEROXIDA <i>OR ORM 0090-20 FKM 80 FD GREEN PEROXIDA</i>
	49		U302.001	NUT HEXAGONAL M5 UNI 5588 <i>DADO ESAGONALE M5 UNI 5</i>
	50		U302.003	МЕТАЛЕВА ГАЙКА M4 UNI 5588 ZNP <i>DADO ESAGONALE M4 UNI 5588 ZNP</i>
	51		11013174	OR ORM 0050-20 FKM 80 FD GREENPEROXIDA <i>OR ORM 0050-20 FKM 80 FD GREEN PEROXIDA</i>
	52		11006046	PEG FOR BOILER <i>PEG FOR BOILER</i>
	53		U044.013	SCREW TSPC M4,0X12 UNI 7688 GALV. <i>VITE TSPC M4,0X12 UNI 7688 ZNP</i>
	54		129825502	TCB SCREW M4X25 UNI 7687 ZNP <i>TCB SCREW M4X25 UNI 7687 ZNP</i>
	55		11004265	CENTRAL UNIT MOTOR STEEL CARTER <i>CENTRAL UNIT MOTOR STEEL CARTER</i>
	55		11014251	CENTRAL UNIT MOTOR STEEL CARTER <i>CENTRAL UNIT MOTOR STEEL CARTER</i>

Model Machine

MACSAE114





























SAECO CRISTALLO 400 ЧЕРНАЯ

	56		129511903	SCREW TCB 2,9X6,4 DIN 7981 BZNICK SCREW TCB 2,9X6,4 DIN 7981 BZ NICK
	57		U034.001	SCREW TCI M3,0X30 UNI 6107 GALV. VITE TCI M3,0X30 UNI 6107 ZNP
	58		9991.015	PLATE FOR MICRO PIASTRINA X MICRO
	59		9991.013	JOINT FOR RATIOMOTOR GIUNTO X MOTORIDUTTORE
	60		U043.007	SCREW TCBC M3,0X8 UNI 7687 GALV. SCREW TCBC M3,0X8 UNI 7687 GALV.
	61		1813.103.A20	RING NUT OF GRIND REGULATION RING NUT OF GRIND REGULATION
	62		U701.011	STEEL SNAP RING 5 UNI 7434 ANELLO ELASTICO 5 UNI 7434
	63		1813.046.050	RUBBER GRIND SUPPORT RUBBER GRIND SUPPORT
	64		1813.045.A20	GRIND SUPPORT GRIND SUPPORT
	65		1813.097.A20	SPACER SPACER
	66		1813.177	SUPPORT SEAL SUPPORT SEAL
	67		12002052	ZN-B TCB SCREW M4X16 ZN-B TCB SCREW M4X16
	68		U203.001	ШАЙБА 4,3X8 UNI 1749 GA PLAIN WASHER 4,3X8 UNI 1749 GAL

Model Machine

MACSAE114











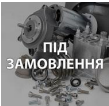















SAECO CRISTALLO 400 ЧЁРНАЯ

	69		9141.003	SPACER FOR RUBBER SPACER FOR RUBBER
	70		9991.005	RUBBER FOR COFFEE GRINDER GOMMINO X MACINA CAFFE
	71		9140.001.00A	COFFEGRINDER MOTOR ASS.220/230V ASS.MOTORE MACINACAFFE'220/2
	71		9140.001.00F	COFFEGRINDER MOTOR ASS.120V COFFEGRINDER MOTOR ASS.120V
	72		11003768	ASS.RATIOMOTOR CRISTALLO400 120V ASS.RATIOMOTOR CRISTALLO400 120V
	72		11005172	ASS.RATIOMOTOR CRISTALLO400 220/60 ASS.RATIOMOTOR CRISTALLO400 220/60
	72		9120.060.00A	ASS.RATIOMOTOR FOR DA 230V FS400 ASS.MOTORIDUTTORE X DA 230V FS400
	73		U207.002	PLAIN WASHER 4,3X9 UNI 6592 GAL ROSETTA PIANA 4,3X9 UNI 6592 ZNP
	74		9141.008	KNOB ADJUSTMENT SCREW KNOB ADJUSTMENT SCREW
	75		140321560	O-RING 3187 NBR OR 3187 IN NBR
	76		9141.081	МЕТАЛЕВИЙ ПОДРІБНЮВАЧ D.43 TIN SAECO (1 ШТ) MACINA PIANA D.43 TIN NB) PREZZO ACQUISTO PER 1 PEZZO
	77		9141.001	BRASS NCREMENT SCREW MC BRASS NCREMENT SCREW MC
	78		9141.007	FAN VENTOLINA
	79		9140.002.00A	MOTOR ASS.WITH CAP 230V ASS.MOTORE CON CALOTTA 230V

Model Machine

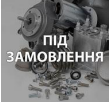
MACSAE114















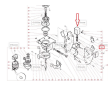

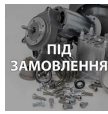







SAECO CRISTALLO 400 ЧЁРНАЯ

	79	 ПІД ЗАМОВЛЕННЯ	9140.002.00F	MOTOR ASS.WITH CAP 120V <i>MOTOR ASS.WITH CAP 120V</i>
	80		0701.R34	MOTOR BRUSH <i>SPAZZOLA X MOTORE MACINACAFFE'</i>
	81	 ПІД ЗАМОВЛЕННЯ	15000422	LABEL GRADUATION GRINDING <i>LABEL GRADUATION GRINDING</i>
	82		1813.159	ANTIVIBRATION RUBBER <i>ANTIVIBRATION RUBBER</i>
	83		1813.104.A20	ADJUSTMENT SCREW WITH TUBE HOLDER <i>VITE REGOLAZIONE MACININO</i>
	84		U044.022	SCREW TSPC M5,0X8 UNI 7688 GALV. <i>SCREW TSPC M5,0X8 UNI 7688 GALV.</i>
	85		9141.005	KNOB PIN <i>PERNO MANOPOLA</i>
	86		126769118	SPRING FOR KNOB STOP PIN (H=19) <i>SPRING FOR KNOB STOP PIN (H=19)</i>
	87		U116.006	SCREW AUT.PT TCB 3,5X12 WN 1441 ZNP <i>VITE AUT.PT TCB 3,5X12 WN 1441 ZNP</i>
	88	 ПІД ЗАМОВЛЕННЯ	11033675	DOSER <i>DOSER</i>
	88	 ПІД ЗАМОВЛЕННЯ	11033677	DOSER <i>DOSER</i>
	88	 ПІД ЗАМОВЛЕННЯ	1813.A10.A2N	DOSER ASS. 6-11 GR. 220V 60HZ <i>DOSER ASS. 6-11 GR. 220V 60HZ</i>
	89	 ПІД ЗАМОВЛЕННЯ	12002151	TSP SCREW M3X4 UNI 7688 SS <i>TSP SCREW M3X4 UNI 7688 SS</i>
	90	 <small>liberty</small>	1813.042.A20	DISPENSER PALLET <i>DISPENSER PALLET</i>

Model Machine

MACSAE114











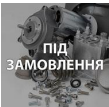



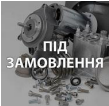











SAECO CRISTALLO 400 ЧЁРНАЯ

	91		9121.235.00A	ELECTROMAGNET FOR DISPENSER WITH NUCLEUS <i>ELETTROM. PER DOSATORE CON NUCLEO</i>
	91		9121.235.00F	ELECTROMAGNET X DISPENSER W/NUCLEUS 120V <i>ELECTROMAGNET X DISPENSER W/NUCLEUS 120V</i>
	91		9121.235.00N	ЕЛЕКТРОМАГНІТ ДЛЯ ДОЗАТОРА W/NUCLEUS 220V <i>ELECTROMAGNET X DISPENSER W/NUCLEUS 220V</i>
	92		11033683	DISPENSER SHELL <i>DISPENSER SHELL</i>
	93		NE15.003	MALE TONGUE PLAIN 6,3 D.5,2 <i>LINGUETTA MASCHIO PIANA 6,3 D.5,2</i>
	94		129821402	TCB SCREW M3X4 UNI 7687 ZNP <i>TCB SCREW M3X4 UNI 7687 ZNP</i>
	95		1813.127	SPRING FOR ELECTROMAGNET <i>MOLLA X ELETTROMAGNETE DOSAT</i>
	96		1813.092	PIN <i>PIN</i>
	97		1813.091	PIN FOR DISPENSER REGULATION <i>PIN FOR DISPENSER REGULATION</i>
	98		1813.043.A20	DISPENSER REGULATION <i>REGOLATORE DOSATORE</i>
	99		1813.078.A20	ADJUSTMENT LEVER <i>ADJUSTMENT LEVER</i>
	10001		1813.044.A20	PALLET FOR REGULATION <i>PALETTA X REGOLATORE</i>
	1010		NE05.062	MICROSWITCH + WHEEL <i>MICROINTERRUTTORE C/ROTELLA</i>

Model Machine

MACSAE114

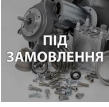
SAECO CRISTALLO 400 ЧЁРНАЯ

	1020	 ПІД ЗАМОВЛЕННЯ	U116.004	SCREW AUT.PT TCB 3,0X16 WN 1441 SCREW AUT.PT TCB 3,0X16 WN 1441
	1030	 Liberty	1813.191.A20	DISPENSER COVER COPERTURA DOSATORE
	1040	 ПІД ЗАМОВЛЕННЯ	11033684	OUTSIDE SHELL DISPENSER GUSCIO EST.DOSATORE 1813.041.A20 LAV.
	1050	 ПІД ЗАМОВЛЕННЯ	12000390	SCREW AUT.TCB 2,9X25 DIN 7981C NIK SCREW AUT.TCB 2,9X25 DIN 7981 C NIK
	1060		12002039	SCREW TCBD TORX 20 M4X12 ZN-B VITE TCBD TORX 20 M4X12 ZN-B
	1070	 ПІД ЗАМОВЛЕННЯ	140328059	OR 2015 SILICONE PTFE/FDA OR 2015 SILICONE PTFE/FDA
	1080		9011.144	SS FORK FOR TUBE D=4 FORCELLA X TUBO D.4
	1090	 ПІД ЗАМОВЛЕННЯ	9972.236	BLACK SILICONE TUBE 7,5X9,3 L=200 MM BLACK SILICONE TUBE 7,5X9,3 L=200 MM
	1100		12001810	OR 275 DE.8,04 SILICONE PERNOMANICOTTO OR 275 DE.8,04 SILICONE PERNO MANICOTTO
	1110		20007305	ЧАСТИНА ЕЛЕКТРОМАГНІТНОГО КЛАПАНА З ПОДВИЖНИМ СЕРДЕЧНИК... SPARE EV MOBILE CORE 11023762
	1110		20007362	SPARE CORE EV ODE RIC. NUCLEO EVT ODE
	1120	 ПІД ЗАМОВЛЕННЯ	20007306	SPARE EVT HS1 11023762 SPARE EVT HS1 11023762
	1120	 ПІД ЗАМОВЛЕННЯ	20007363	SPARE EVT ODE SPARE EVT ODE
	1130	 ПІД ЗАМОВЛЕННЯ	20007364	SPARE EVT 11032408 SPARE EVT 11032408

Model Machine

MACSAE114

SAECO CRISTALLO 400 ЧЁРНАЯ

MACSAE114.T.0014



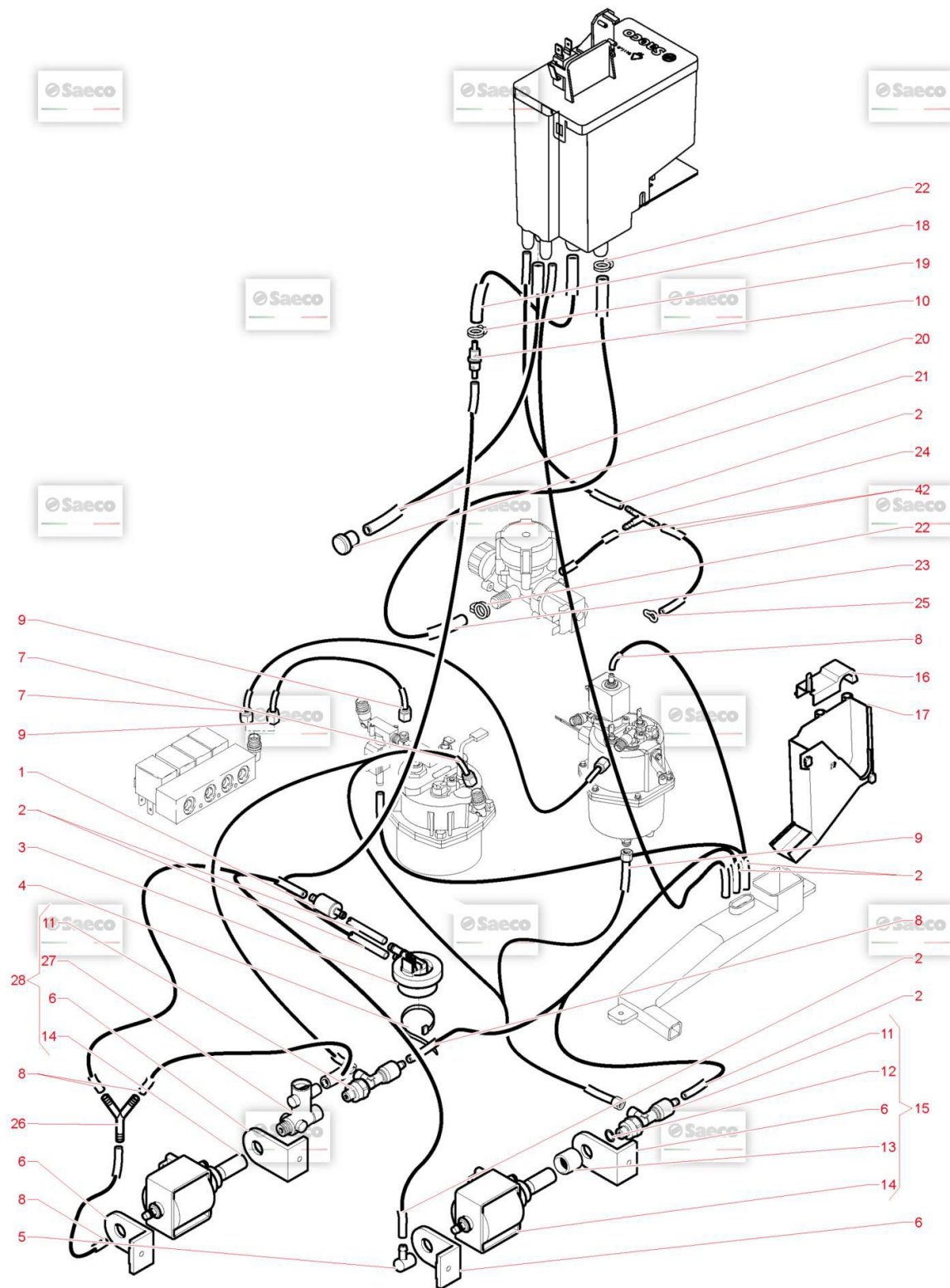









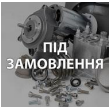













TAVOLA NR. 14 - ARTICOLO SAECO CRISTALLO 400 ЧЁРНАЯ



Model Machine

MACSAE114

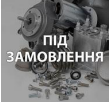











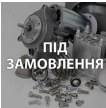

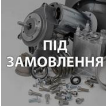









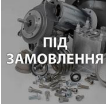

SAECO CRISTALLO 400 ЧЁРНАЯ

Web	Pos.	Foto	Item - Replace by	Description
				<i>Press - CTRL + CLICK go to item in a new window Натисніть - Ctrl + права кнопка миші щоб відкрити запчастину в новому вікні</i>
	1		11024178	WATER FILTER PHEDRA WATER FILTER PHEDRA
	2		9972.057	КОРИЧНЕВА ГУМОВА ТРУБКА 5X8 2 МЕТРИ TUBO SILICONE MARRON 5X8 L.2000 MM
	3		NV99.099	TURBINE D=1,2 ASSY. TURBINA DIGMESA FHKSC 1,2 ARNITE OC
	4		144320200	SELF LOCK STRIP W=2.6 L=200 SELF LOCK STRIP W=2.6 L=200
	5		147920150	90° INLET PUMP CONNECTOR RACCORDO A 90° IN SANTOPRENE
	6		149185850	ТРИМАЧ (ГУМОВИЙ)ПОМПИ ДЛЯ КАВОМАШИН SAECO MAGIC 4002012 (... SUPPORTO POMPA EATON MAGIC 4
	7		11025297	TEFLON TUBE 3X6 L.310 1/8"-1/8 TEFLON TUBE 3X6 L.310 1/8"-1/8
	8		9972.247	SILICONE TUBE 5X10 L.1400MM TUBO SILICON.5X10 L=2000MM 60 SHORE
	9		11025292	TEFLON TUBE 3X6 L.230 1/8"-1/8 TEFLON TUBE 3X6 L.230 1/8"-1/8
	10		144650300	ФІЛЬТР ОЧИСТКИ ВОДИ ДЛЯ КАВОМАШИНИ SAECO NEW (NV99.001) (88... ASPIRATION FILTER GAUZE NET 500 (NEW)
	11		11005590	SAFETY VALVE/NON RETURN ASS. NEW ASS.VALVOLA SICUREZZA/NON RI
	12		NM02.020	OR 2031 TERMOIL OR 2031 TERMOIL
	13		9071.098	REINFORCEMENT FOR ULKA PUMP REINFORCEMENT FOR ULKA PUMP

Model Machine

MACSAE114











SAECO CRISTALLO 400 ЧЁРНАЯ

	14		9070.042.00A	ULKA НАСОС (ПОМПА) EX5GW 230/240V 50HZ SD1 БЪЯНКО 15 BAR <i>ULKA PUMP EX5 SD1</i>
	14		9070.042.00N	PUMP 220V <i>ULKA PUMP EX5 SD1</i>
	14		9070.044.00F	PUMP 120V-60HZ <i>ULKA PUMP EP5 D1</i>
	15		9070.043.00A	ULKA PUMP+NON RETURN <i>ULKA PUMP EX5 SD1 +NON RETURN</i>
	15		9070.043.00N	PUMP+NON RETURN <i>ULKA PUMP EX5 SD1 +NON RETURN</i>
	15		9070.045.00F	PUMP 120V <i>ULKA PUMP ASS.EP5 D1 120V</i>
	16		9161.262.060	DRIP CHANNEL COVER <i>COPERTURA CANALINO RACCOGLIGOCCE</i>
	17		9111.597.050	COFFEE DISCHARGE CHANNEL SHORT <i>CANALINO SCARICO CAFFE' CORTO</i>
	18		9972.141	SILICONE TUBE 7X11 L.160MM <i>SILICONE TUBE 7X11 L.160 MM</i>
	19		NV99.072	HOSE CLAMP D. 11.6/12.3 <i>HOSE CLAMP D. 11.6/12.3</i>
	20		9972.335	SILICONE TUBE 7X11 L.135MM <i>TUBO SILICONE 7X11 L.1240 MM</i>
	21		NV03.006	CAP KAPSTO LPN 615/010 <i>TAPPO KAPSTO LPN 615/010</i>
	22		NV99.050	HOSECLAMP D. 13.3/14.1 <i>HOSECLAMP D. 13.3/14.1</i>
	23		9972.134	SILICONE TUBE 7X11 L.850MM <i>SILICONE TUBE 7X11 L.850 MM</i>

Model Machine

MACSAE114

SAECO CRISTALLO 400 ЧЁРНАЯ

	24		NV99.004	CONNECTOR T MORONI 8026047 D=8 CONNECTOR T MORONI 8026047 D=8
	25		9111.141	DISCHARGE TUBE CLOSURE SPRING DISCHARGE TUBE CLOSURE SPRING
	26		147920800	Y CONNECTOR D=8 ART.80.26.048KA.466 RACCORDO Y D=8 ART.80.26.048 KA.466
	27		20007360	ОБХІДНИЙ КЛАПАН FLUID-O-TECH B7E BYPASS VALVE FLUID-O-TECH B7E
	28		11032988	ASSMEBLY PUMP EX5 SD1 230V ASSMEBLY PUMP EX5 SD1 230V

Model Machine

MACSAE114

SAECO CRISTALLO 400 ЧЁРНАЯ

MACSAE114.T.0015

TAVOLA NR. 15 - ARTICOLO SAECO CRISTALLO 400 ЧЁРНАЯ

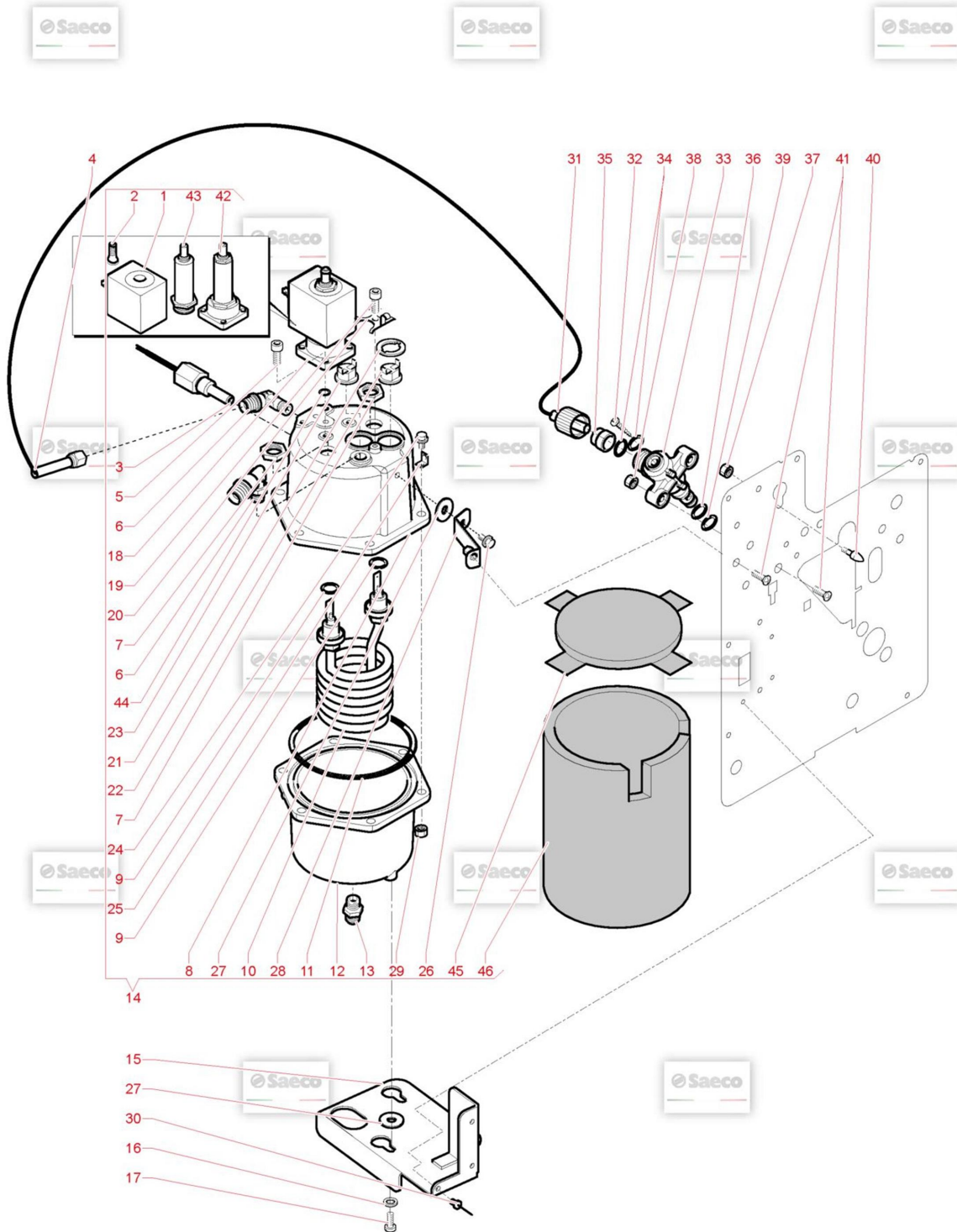

Model Machine

MACSAE114

SAECO CRISTALLO 400 ЧЁРНАЯ

Web Pos. Foto Item - Replace by Description



Press - CTRL + CLICK go to item in a new window

Натисніть - Ctrl + права кнопка миші щоб відкрити запчастину в новому вікні



1



20006583

COIL EVT HS2 11012534

COIL 11005360 11006877 11012534/533



1



20007361

SOLENOID EVT ODE

SOLENOID EVT ODE



2



20006974

MOBILE NUCLEUS OLAB 8000-836

MOBILE NUCLEUS OLAB 8000-836



2



20007362

SPARE CORE EV ODE

RIC. NUCLEO EVT ODE



3



11005368

IMMERSION PROBE ASS.

ASS.SONDA TEMPER.AD.IMMERSIONE



4

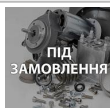

11025409

TUBE ASSEMBLY TEFLON 3X6 L.220MM

TUBE ASSEMBLY TEFLON 3X6 L.220MM



5

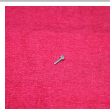

12001179

SCREW TCEI M4,0X12 UNI 5931 8.8 ZIN.

SCREW TCEI M4,0X12 UNI 5931 8.8 ZIN.



6

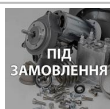

12001181

BICONICAL CONNECT. L M 1/8X06TEA

BICONICAL CONNECT. L M 1/8X06 TEA



7



9991.029

NUT FOR RESISTOR

DADO X RESISTENZA



8



11012528

UPPER CASING BOILER 600CC TEA

UPPER CASING BOILER 600CC TEA



9

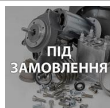

11000972

OR 3050 FKM 80 FD PEROXIDICA

OR 3050 FKM 80 FD PEROXIDICA



10



11005367

ЕЛЕКТРОВОДОНАГРІВАЧ 230V 1550W

HEAT ELEMENT BOILER 230V 1550W



10

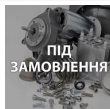

11005374





























HEAT ELEMENT BOILER 120V 1100W

HEAT ELEMENT BOILER 120V 1100W

Model Machine

MACSAE114



















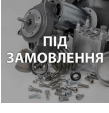



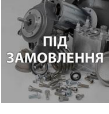

SAECO CRISTALLO 400 ЧЁРНАЯ

	11		12000770	OR ORM 4350 VITON <i>OR METRICO 4350 IN VITON</i>
	12		11012529	LOWER CASING BOILER 600CC TEA <i>LOWER CASING BOILER 600CC TEA</i>
	13		11027089	WATER INLET CONNECTOR <i>WATER INLET CONNECTOR</i>
	14		11025320	BOILER ASS. CRISTALLO600 600CC120/60 TEA <i>BOILER ASS. CRISTALLO600 600CC120/60 TEA</i>
	14		11025321	BOILER 600CC 230/50 TEA <i>BOILER ASS. CRISTALLO600 600CC 230/50 TEA</i>
	15		11008090	SUPPORT PLATE BOILER 600CC <i>SUPPORT PLATE BOILER 600CC</i>
	16		U207.001	PLAIN WASHER 5,3X10 UNI 6592 GAL <i>ROSETTA PIANA 5,3X10 UNI 6</i>
	17		U005.011	SCREW TE M4,0X10 UNI 5739 GALV. <i>SCREW TE M4,0X10 UNI 5739 GALV.</i>
	18		11012534	TEA ELECTROVALVE 2/3 WAY N.C. <i>TEA ELECTROVALVE 2/3 WAY N.C.</i>
	19		12001052	SCREW TCEI M4,0X6 DIN 912 ZIN <i>SCREW TCEI M4,0X6 DIN 912 ZIN</i>
	20		226760100	RETAINING SPRING 3 THERMOSTATS <i>RETAINING SPRING 3 THERMOSTATS</i>
	21		9991.085	THERMOSTAT FIXING WASHER <i>RONDELLA FERMATERMOSTATI</i>
	22		NE09.021	THERMOSTAT 150°NC FASTON 90° <i>TERMOSTATO 150°NC FASTON 90°</i>
	23		189428700	THERMOSTAT 175° 1NT-15L-5126 <i>THERMOSTAT 175° 1NT-15L-5126</i>

Model Machine

MACSAE114



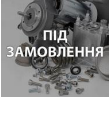











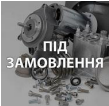







SAECO CRISTALLO 400 ЧЁРНАЯ

	24		U023.020	SCREW TCEI M6X20 UNI 5931 ZIN <i>VITE TCEI M6X20 UNI 5931 8.8</i>
	25		NE15.031	MALE TONGUE PLAIN 6,3 D.6,3 <i>MALE TONGUE PLAIN 6,3 D.6,3</i>
	26		U046.005	SCREW TE M5,0X10 WITH WASHER <i>SCREW TE M5,0X10 WITH WASHER</i>
	27		9111.501	INSULATION WASHER <i>INSULATION WASHER</i>
	28	 ПІД ЗАМОВЛЕННЯ	11008063	BOILER 600CC SUPPORT CRISTALLO600 <i>SUPPORTO CALDAIA 600CC CRISTALLO600</i>
	29		U302.004	NUT HEXAGONAL M6 UNI 5588 <i>DADO ESAGONALE M6 UNI 5</i>
	30	 ПІД ЗАМОВЛЕННЯ	NF11.115	BLIND RIVETS <i>BLIND RIVETS</i>
	31		11005743	KNURLED FEMALE HAND BOLT M14 <i>GODRONE FEMMINA M14</i>
	32		U109.037	SCREW AUT.TCB 4,8X13 DIN 7981C <i>VITE AUT.TCB 4,8X13 DIN 7981 C NIK</i>
	33		11005370	PIN FOR MUFF <i>PERNO X MANICOTTO PIN FOR MUFF</i>
	34		140321462	O-RING 2018 SILICONE <i>OR 2018 IN SILICONE</i>
	35		11005741	CONNECTOR D.6 <i>BOCCOLA ESTERNA D.6</i>
	36	 ПІД ЗАМОВЛЕННЯ	11013173	OR ORM 0090-20 FKM 80 FD GREENPEROXIDA <i>OR ORM 0090-20 FKM 80 FD GREEN PEROXIDA</i>

Model Machine

MACSAE114

SAECO CRISTALLO 400 ЧЁРНАЯ

	37		U302.001	NUT HEXAGONAL M5 UNI 5588 <i>DADO ESAGONALE M5 UNI 5</i>
	38		U302.003	МЕТАЛЕВА ГАЙКА M4 UNI 5588 ZNP <i>DADO ESAGONALE M4 UNI 5588 ZNP</i>
	39		11013174	OR ORM 0050-20 FKM 80 FD GREENPEROXIDA <i>OR ORM 0050-20 FKM 80 FD GREEN PEROXIDA</i>
	40		11006046	PEG FOR BOILER <i>PEG FOR BOILER</i>
	41		U044.013	SCREW TSPC M4,0X12 UNI 7688 GALV. <i>VITE TSPC M4,0X12 UNI 7688 ZNP</i>
	42		20007311	SPARE EVT HS2 11012534 <i>SPARE EVT HS2 11012534</i>
	42		20007370	SPARE EVT 11012534 <i>SPARE EVT 11012534</i>
	43		20007310	SPARE EVT HS2 11012534 <i>SPARE EVT HS2 11012534</i>
	43		20007363	SPARE EVT ODE <i>SPARE EVT ODE</i>
	44		20007312	SPARE OR EVT HS2 11012534 <i>SPARE OR EVT HS2 11012534</i>
	45		11030776	COFFEE BOILER 600CC UPPER ISOLATOR <i>ISOLANTE SUP.CALDAIA 600CC VENDING</i>
	46		11030778	COFFEE BOILER 600CC UPPER ISOLATOR <i>ISOLANTE PERIMETR.CALDAIA 600CC VENDING</i>

Model Machine

MACSAE114

SAECO CRISTALLO 400 ЧЁРНАЯ

MACSAE114.T.0016



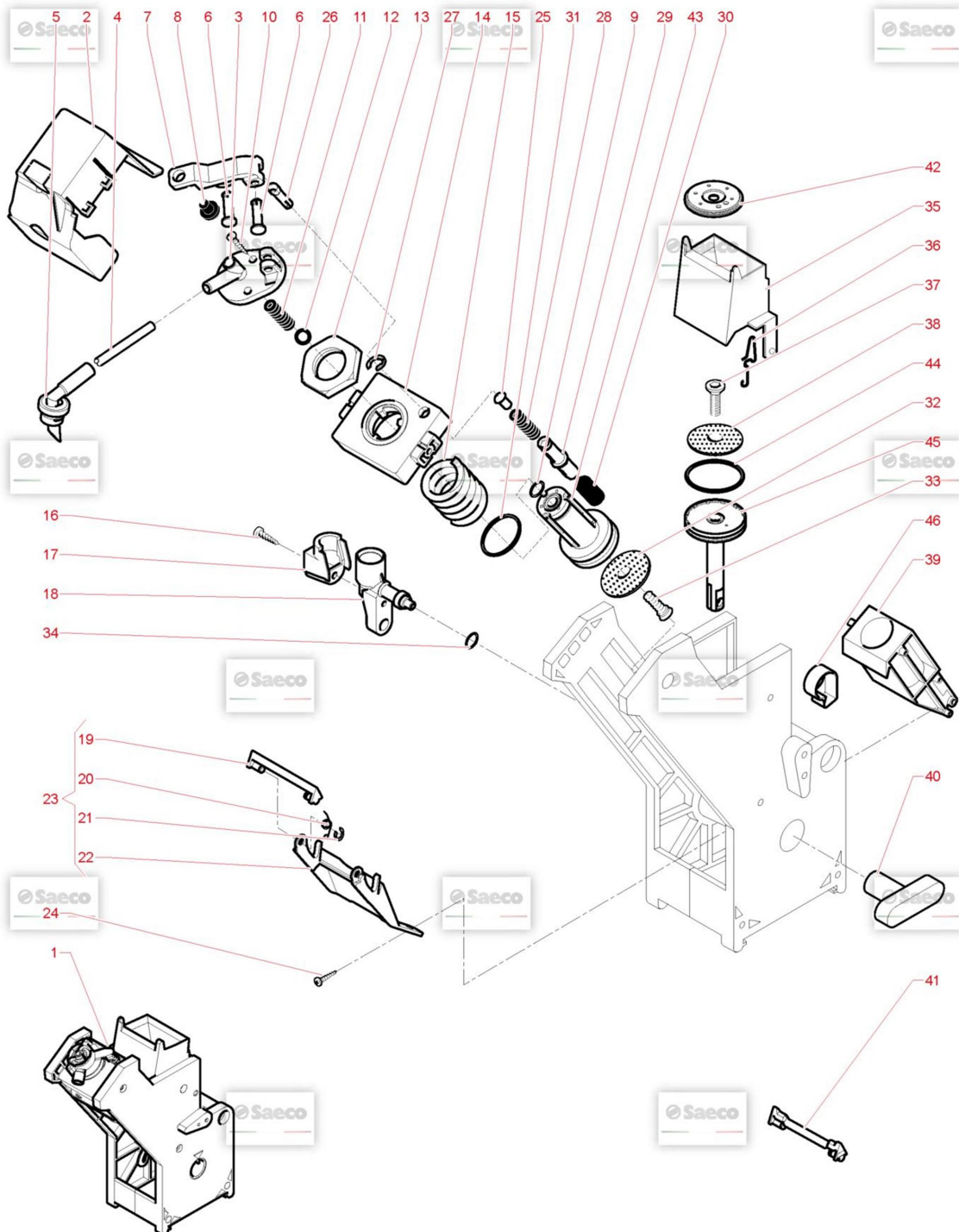























TAVOLA NR. 16 - ARTICOLO SAECO CRISTALLO 400 ЧЁРНАЯ



Model Machine

MACSAE114





























SAECO CRISTALLO 400 ЧЁРНАЯ

Web	Pos.	Foto	Item - Replace by	Description
				<i>Press - CTRL + CLICK go to item in a new window Натисніть - Ctrl + права кнопка миші щоб відкрити запчастину в новому вікні</i>
	1		11030408	BREWING UNIT ASS. 7GR GRAN GUSTO ASS. GRUPPO CAFFE 6/8GR NEW
	2		11029737	PROTECTION VALVE PROTEZIONE VALVOLA SFIATO GRUPPO CAFFE
	3		11029311	COVER BALL VALVE COPERCHIO VALVOLA SFERA
	4		9972.345	SILICONE TUBE 3,5X9 L.340MM SILICONE TUBE 3,5X9 L.340MM
	5		11033574	COFFEE NOZZLES COFFEE NOZZLES
	6		11030836	ШПЛИНТ ФІКСАЦІЇ СУППОРТУ КЛАПАНА PIN FIXING VALVE SUPPORT
	7		11029312	BREATHER VALVE CLOSED CHIUSURA VALVOLA SFIATO
	8		NV01.009	RUBBER BUFFER GOMMINO PARACOLPI
	9		NM01.029	OR ORM 0100-15 SILICONE OR ORM 0100-15 SILICONE
	10		U109.006	SCREW AUT.TCB 2,2X9,5 DIN 7981C VITE AUT.TCB 2,2X9,5 DIN 7981 C NIK
	11		126771918	SS COFFEE UNIT CONTERPISTON SPRING SMART MOLLA CONTROPIST. GRUP. SMART INOX
	12		12001811	SPHERE TEFLON D.4,5 SFETA D.4.5 TEFLON X VALVOLA GRUPPO CAFF
	13		11029317	NUT SEAL PISTON MOVABLE DADO TENUTA CONTROPISTONE MOBILE

Model Machine

MACSAE114



























SAECO CRISTALLO 400 ЧЁРНАЯ

	14		11029316	FLANGE FOR CUPHOLDER <i>FLANGIA X PISTONE MOBILE</i>
	15		11029308	SPRING FOR MOVABLE COUNTERPISTON <i>MOLLA X CONTROPISTONE MOBILE</i>
	16		129512921	SCREW TCB TORX 10 AB 2,9X13 SHEET SS <i>SCREW TCB TORX 10 2,9X13 SHEET SS</i>
	17		11010013	CARTER FOR MUFF PREHEATING UNIT <i>CARTE X MANICOTTO GRUPPO PRERISCALDO</i>
	18		11005371	UNIT COFFEE MUFF <i>MANICOTTO GRUPPO CAFFE' UNIT COFFEE MUFF</i>
	19		9111.537.060	BROWN SCRAPER COFFEE GROUP <i>BROWN SCRAPER COFFEE GROUP</i>
	20		9111.520	SPRING FOR SCRAPER SECTION 0.6 <i>SPRING FOR SCRAPER SECTION 0.6</i>
	21		U701.006	ФІКСУЮЧА СКОБА 3,2 (ЗАЛІЗО) SAECO <i>ANELLO ELASTICO 3,2</i>
	22		9111.539.060	FORK FOR SCRAPER <i>FORCELLA PER RASCHIATORE</i>
	23		9110.067.060	SCRAPER ASS.FOR CAPPUCCINAT. TUBE <i>ASS.RASCHIATORE X SG500/700</i>
	24		U110.013	БОЛТ МЕТАЛЕВИЙ 3,9X6,5 DIN 7981 F <i>SCREW AUT.TCB 3,9X6,5 DIN 7981 F</i>
	25		9161.320	VALVE FOR UNIT <i>VALVOLA X GRUPPO CAFFE'</i>
	26		11029313	CURSOR COMPENSATOR VALVE VENT <i>CURSORE COMPENSATORE X VALVOLA SFIATO</i>
	27		U701.007	ЕЛАСТИЧНЕ КІЛЬЦЕ 6 UNI 7434 (ЗАЛІЗО) <i>ЕЛАСТИЧНЕ КІЛЬЦЕ 6 UNI 7434 (ЗАЛІЗО)</i>

Model Machine

MACSAE114









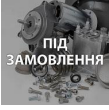

SAECO CRISTALLO 400 ЧЕРНАЯ

	28		11029310	SPRING FOR RELIEF VALVE <i>MOLLA COMPENSATRICE X VALVOLA SFIATO</i>
	29		11029314	CURSOR FOR VALVE VENT <i>CURSORE X VALVOLA SFIATO</i>
	30		11029309	SPRING FOR RELIEF VALVE <i>MOLLA X VALVOLA SFIATO</i>
	31		140322061	O-RING 4112 EPDM <i>OR 4112 IN EPDM</i>
	32		11012630	PERCOLATOR D.34 <i>PERCOLATOR D.34</i>
	33		U044.009	SS SCREW TSPC M3,0X8 UNI 7688 <i>VITE TSCP M3,0X8 UNI 7688 INO</i>
	34		140321462	O-RING 2018 SILICONE <i>OR 2018 IN SILICONE</i>
	35		322001201	MOBILE SCRAPER BROWN NARROW <i>MOBILE SCRAPER BROWN NARROW</i>
	36		9161.425	SPRING FOR SCRAPER <i>SPRING FOR SCRAPER</i>
	37		129851921	TSP SCREW M3X6 UNI 7688 SS <i>TSP SCREW M3X6 UNI 7688 SS</i>
	38	 ПІД ЗАМОВЛЕННЯ	324000200	SS PERCOLATOR D=34 FOR UNIT <i>SS PERCOLATOR D=34 FOR UNIT</i>
	39		222711101	BROWN GROUND COFF.CONTAINER D=36 ASSY. <i>BROWN GROUND COFF.CONTAINER D=36 ASSY.</i>
	40		9161.021.060	KEY FOR BREW UNIT BROWN <i>CHIAVE X GRUPPO CAFFE' MARRO</i>

Model Machine

MACSAE114

SAECO CRISTALLO 400 ЧЁРНАЯ

	41		11012957	SCRAPER FOR COFFEE UNIT 7-9GR. <i>SCRAPER FOR COFFEE UNIT 7-9GR.</i>
	42		11030122	SPACE <i>SPACE</i>
	43		11029878	ASS.CONTROPISTONE MOBILE <i>ASS.CONTROPISTONE MOBILE</i>
	44		140322500	ПРОКЛАДКА O-RING 2118 SH70 BIANCHI 36363116-01, SAECO 140322500 <i>OR 2118 IN NITRIL RUBBER</i>
	45		11029879	ПОРШЕНЬ РОБОЧОГО БЛОКУ X 7 ГРАМ <i>ASS.PISTONE X GRUPPO CAFFE'</i>
	46		11030309	RING FOR CAM <i>ANELLO X CAMMA PISTONE</i>

Model Machine

MACSAE114

SAECO CRISTALLO 400 ЧЁРНАЯ

MACSAE114.T.0017

TAVOLA NR. 17 - ARTICOLO SAECO CRISTALLO 400 ЧЁРНАЯ

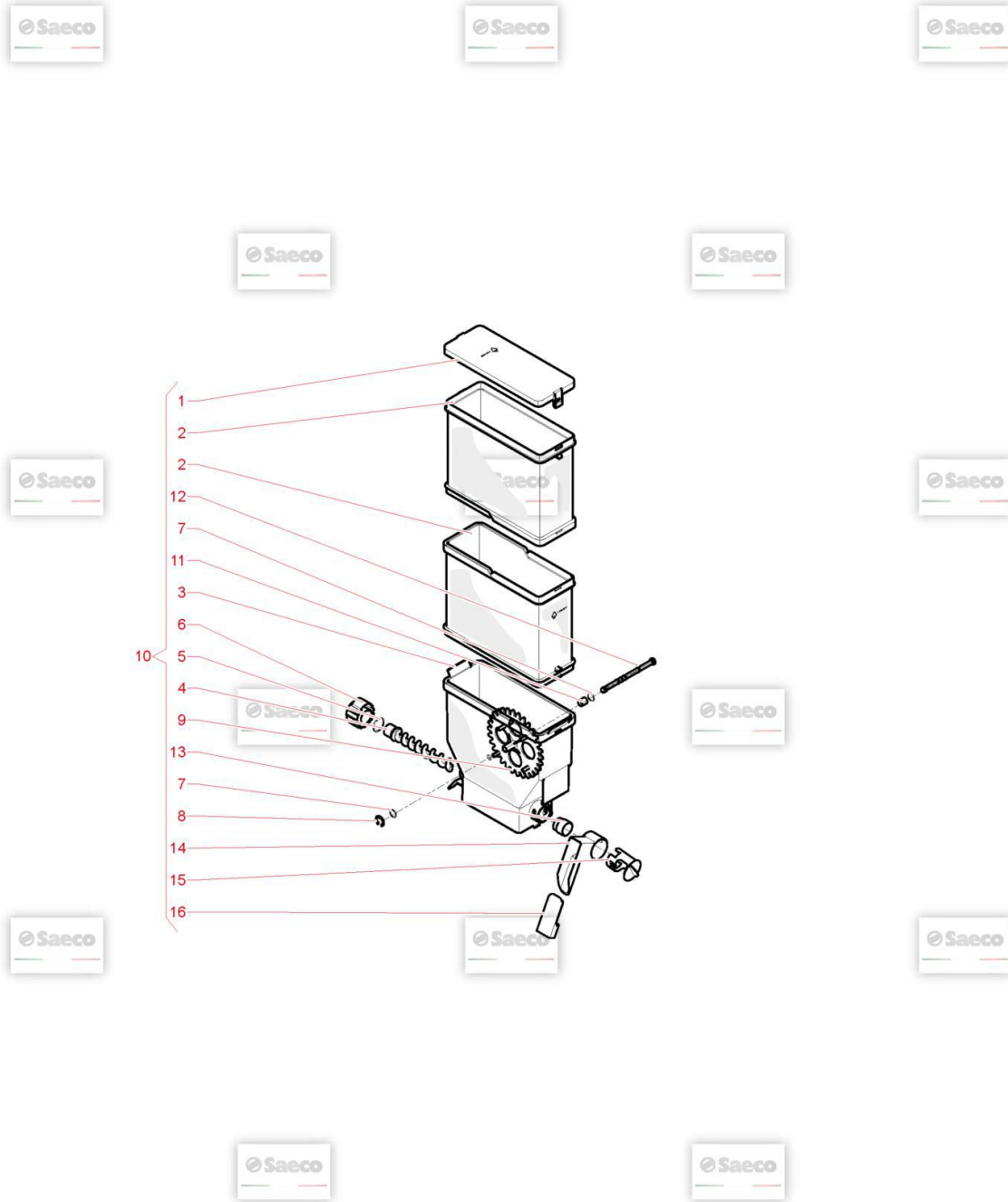

Model Machine

MACSAE114

SAECO CRISTALLO 400 ЧЁРНАЯ

Web Pos. Foto Item - Replace by Description



Press - CTRL + CLICK go to item in a new window
Натисніть - Ctrl + права кнопка миші щоб відкрити запчастину в новому вікні



1



11001578

COVER CONTAINER SINGLE SOLUBLE
COPERCHIO CONTENITORE SOLUBILE SINGOLO



2



11001577

EXTENSION CONTAINER SINGLE SOLUBLE
PROLUNGA CONTENITORE SOLUBILE SINGOLO



3



11001576

BASE CONTAINER SINGLE SOLUBLE
BASE CONTENITORE SOLUBILE SINGOLO



4

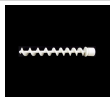

11001658

SCROLL SCREW
COCLEA PER DEVIATORE



5



NM03.013

OR 2,3X15 NBR
OR 2,3X15 NBR



6



11012130

BACK BUSH REINFORCE
BACK BUSH REINFORCE



7



NM03.022

OR ORM 0060-10 NBR
OR ORM 0060-10 NBR



8



U701.003

SNAP RING 7 UNI 7434
ANELLO ELASTICO 7 UNI 7434



9



9111.702

WHEEL DOUBLE CONTAINER
RUOTA CONTENITORE DOPPIO



10



11004505

ASSEMBLY SINGLE CONTAINER W/SWITCH
ASS.MONTATO CONT.SINGOLO C/DEVIATORE



11



11032945

SPACE FOR GEAR BPA FREE
SPACE FOR GEAR BPA FREE



12



11001580

PIN WHEEL CONTAINER SINGLE SOLUBLE
PERNO RUOTA DENTATA CONT.SOLUB.SINGOLO



13



11001654

BUSH CONTAINER
BOCCOLA CONTENITORE

Model Machine

MACSAE114

SAECO CRISTALLO 400 ЧЁРНАЯ



14



9111.425.060

POWDER DUCT

CONDOTTO POLVERE ORIENTABILE



15



9111.457.060

BUSH FOR LEFT/RIGHT DUCT COSMEC

BOCCOLA X CONDOTTO DX-SX COSMEC



16



9111.428.060

PLUG FOR LEFT-RIGHT DUCT

TAPPO X CONDOTTO DX-SX

Model Machine

MACSAE114

SAECO CRISTALLO 400 ЧЁРНАЯ

MACSAE114.T.0018

TAVOLA NR. 18 - ARTICOLO SAECO CRISTALLO 400 ЧЁРНАЯ

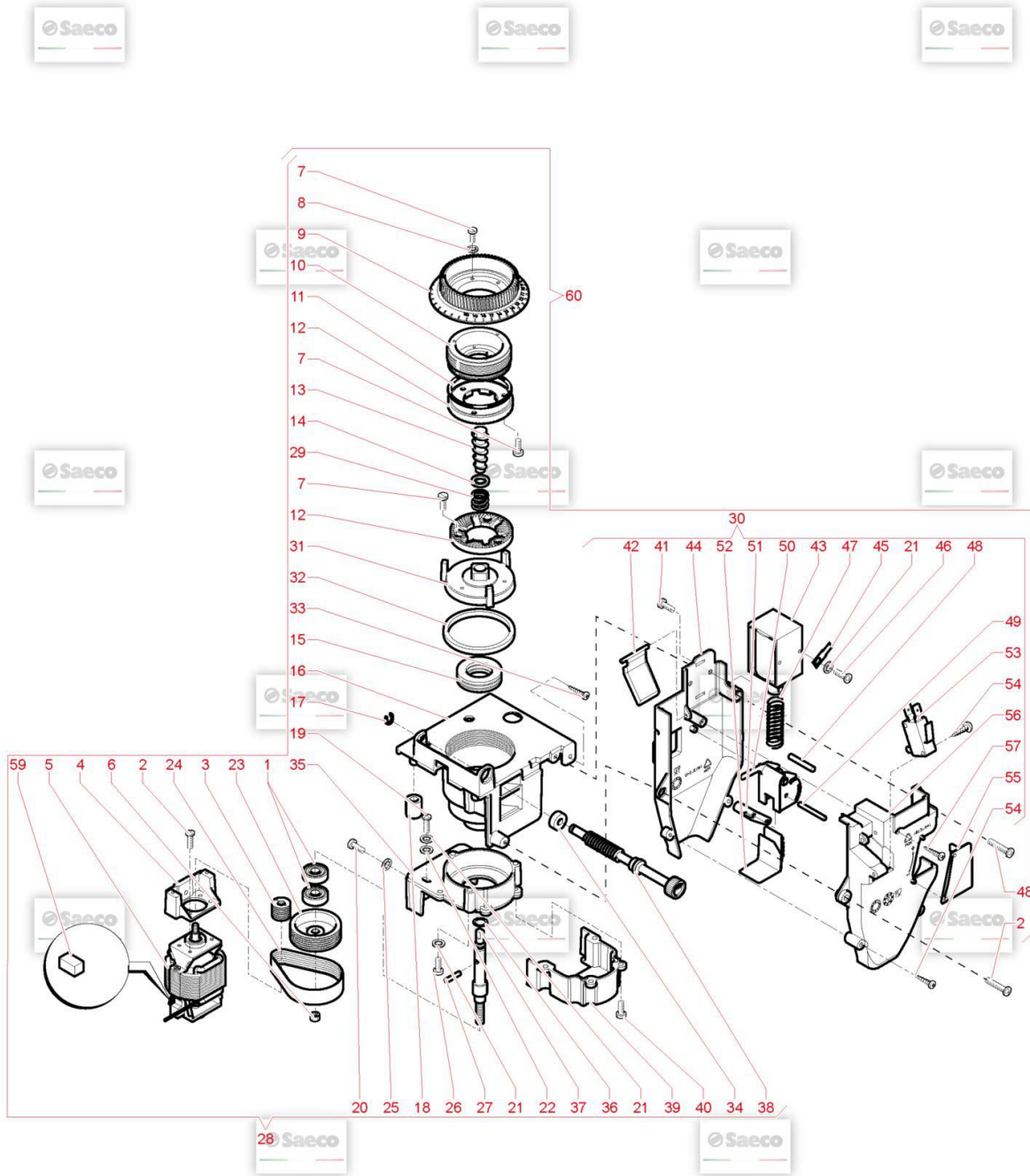

Model Machine

MACSAE114

SAECO CRISTALLO 400 ЧЁРНАЯ

Web Pos. Foto Item - Replace by Description



*Press - CTRL + CLICK go to item in a new window
Натисніть - Ctrl + права кнопка миші щоб відкрити запчастину в новому вікні*



1



11025696

BEARING RTP 608-2Z
BEARING RTP 608-2Z



2



12002039

SCREW TCBD TORX 20 M4X12 ZN-B
VITE TCBD TORX 20 M4X12 ZN-B



3



11025690

PULLEY D.15 "GRIND 48"
PULLEY D.15 "GRIND 48"



4

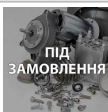

11027163

MOTOR SUPPORT GRINDERS D.48
MOTOR SUPPORT GRINDERS D.48



5

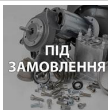

11027396

COFFEEGRINDER MOTOR D.48 230V
COFFEEGRINDER MOTOR D.48 230V



6



U310.004

NUT SELF LOCK.M6 UNI 7473
NUT SELF LOCK.M6 UNI 7473



7



U043.007

SCREW TCBC M3,0X8 UNI 7687 GALV.
SCREW TCBC M3,0X8 UNI 7687 GALV.



8



U208.002

TOOTHED WASHER 3,3X5,8 UNI 3703 G
ROSETTA DENT. 3,3X5,8 UNI 3703 ZNP



9



1813.103.A20

RING NUT OF GRIND REGULATION
RING NUT OF GRIND REGULATION



10



11025692

UPPER GRINDING DISK HOLDER "GRIND 48"
UPPER GRINDING DISK HOLDER "GRIND 48"



11



12001617

OR 3206 NBR
OR 3206 NBR



12



11021838

НІЖ КАВОМОЛКИ SAECO D-48 (1ШТ.)
FLAT MILL D.47 TEA



13































11025695

ШНЕК БОЛТИК ЗБІЛЬШЕННЯ "MACINE 48"
INCREASE SCREW "GRIND 48"

Model Machine

MACSAE114

















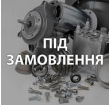





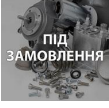

SAECO CRISTALLO 400 ЧЁРНАЯ

	14		11027418	SPACER FOR SCREW OF INCREASE <i>SPACER FOR SCREW OF INCREASE</i>
	15		11025699	BEARING RTP 51104 <i>BEARING RTP 51104</i>
	16		11027162	GRINDERS CAP D.48 <i>GRINDERS CAP D.48</i>
	17		U701.011	STEEL SNAP RING 5 UNI 7434 <i>ANELLO ELASTICO 5 UNI 7434</i>
	18		1813.046.050	RUBBER GRIND SUPPORT <i>RUBBER GRIND SUPPORT</i>
	19		12002052	ZN-B TCB SCREW M4X16 <i>ZN-B TCB SCREW M4X16</i>
	20		U023.004	SCREW TCEI M6,0X12 UNI 5931 GALV. <i>VITE TCEI M6,0X12 UNI 5931 Z</i>
	21		128310404	МЕТАЛЕВЕ УБЧАСТЕ КОЛІЩАТКО UNI 8842 A4 <i>WASHER UNI 8842 A4 BURNISHED</i>
	22		U207.004	PLAIN WASHER 4,3X16 UNI 6592 GAL <i>PLAIN WASHER 4,3X16 UNI 6592 GAL</i>
	23		11025689	PULLEY D.40 "GRIND 48" <i>PULLEY D.40 "GRIND 48"</i>
	24		11032130	BELT GRINDER COFFEE <i>BELT GRINDER COFFEE</i>
	25		U208.006	TOOTHED WASHER 6,4X11 UNI 3703 <i>ROSETTA DENT. 6,4X11 UNI 3</i>
	26		12001700	SCREW TCB M4X30 UNI 7687 ZNP <i>SCREW TCB M4X30 UNI 7687 ZNP</i>
	27		11025921	POWER PLUG UNI-EN 28743 D.3X14 <i>POWER PLUG UNI-EN 28743 D.3X14</i>

Model Machine

MACSAE114











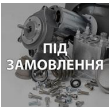

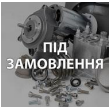













SAECO CRISTALLO 400 ЧЁРНАЯ

	28		11027165	КАВОМОЛКА В ЗБОРІ Д 48 SAECO 11027165 <i>COFFEE GRINDER D.48</i>
	29		11025694	SPRING "GRIND 48" <i>SPRING GRIND 48</i>
	30		11033675	DOSER <i>DOSER</i>
	30		1813.A10.A2N	DOSER ASS. 6-11 GR. 220V 60HZ <i>DOSER ASS. 6-11 GR. 220V 60HZ</i>
	31		11025691	ТРИМАЧ НИЖНЬОГО НОЖА Д.48 <i>LOWER GRINDING DISK HOLDER GRIND 48</i>
	32		11027451	ПРОКЛАДКА DE=47,4 DI=41,4H=4 IN F <i>ПРОКЛАДКА DE=47,4 DI=41,4H=4 IN F</i>
	33		U116.006	SCREW AUT.PT TCB 3,5X12 WN 1441 ZNP <i>VITE AUT.PT TCB 3,5X12 WN 1441 ZNP</i>
	34		1813.159	ANTIVIBRATION RUBBER <i>ANTIVIBRATION RUBBER</i>
	35		11027164	MOTOR SUPPORT GRINDERS D.48 <i>MOTOR SUPPORT GRINDERS D.48</i>
	36		140321662	O-RING 2021 SILICONE <i>OR 2021 IN SILICONE</i>
	37		11025693	CENTRAL PIN "GRIND 48" <i>CENTRAL PIN "GRIND 48"</i>
	38		1813.104.A20	ADJUSTMENT SCREW WITH TUBE HOLDER <i>VITE REGOLAZIONE MACININO</i>
	39		11027186	ЧАСТИНА КРИПЛЕННЯ КАВОМОЛКИ SAECO <i>SHELL CLOSURE BELT</i>

Model Machine

MACSAE114

















SAECO CRISTALLO 400 ЧЁРНАЯ

	40	 ПІД ЗАМОВЛЕННЯ	U127.010	SCREW TAPT.TCB M4,0X10 DIN 7500C <i>SCREW TAPT.TCB M4,0X10 DIN 7500C</i>
	41	 ПІД ЗАМОВЛЕННЯ	12002151	TSP SCREW M3X4 UNI 7688 SS <i>TSP SCREW M3X4 UNI 7688 SS</i>
	42	 Liberty	1813.042.A20	DISPENSER PALLET <i>DISPENSER PALLET</i>
	43		9121.235.00A	ELECTROMAGNET FOR DISPENSER WITH NUCLEUS <i>ELETTROM. PER DOSATORE CON NUCLEO</i>
	44	 ПІД ЗАМОВЛЕННЯ	11033683	DISPENSER SHELL <i>DISPENSER SHELL</i>
	45		NE15.003	MALE TONGUE PLAIN 6,3 D.5,2 <i>LINGUETTA MASCHIO PIANA 6,3 D.5,2</i>
	46		129821402	TCB SCREW M3X4 UNI 7687 ZNP <i>TCB SCREW M3X4 UNI 7687 ZNP</i>
	47		1813.127	SPRING FOR ELECTROMAGNET <i>MOLLA X ELETTROMAGNETE DOSAT</i>
	48		1813.092	PIN <i>PIN</i>
	49		1813.091	PIN FOR DISPENSER REGULATION <i>PIN FOR DISPENSER REGULATION</i>
	50		1813.043.A20	DISPENSER REGULATION <i>REGOLATORE DOSATORE</i>
	51		1813.078.A20	ADJUSTMENT LEVER <i>ADJUSTMENT LEVER</i>
	52		1813.044.A20	PALLET FOR REGULATION <i>PALETTA X REGOLATORE</i>
	53		NE05.062	MICROSWITCH + WHEEL <i>MICROINTERRUTTORE C/ROTELLA</i>

Model Machine

MACSAE114

SAECO CRISTALLO 400 ЧЁРНАЯ

	54	 ПІД ЗАМОВЛЕННЯ	U116.004	SCREW AUT.PT TCB 3,0X16 WN 1441 <i>SCREW AUT.PT TCB 3,0X16 WN 1441</i>
	55	 <small>Liberty</small>	1813.191.A20	DISPENSER COVER <i>COPERTURA DOSATORE</i>
	56	 ПІД ЗАМОВЛЕННЯ	11033684	OUTSIDE SHELL DISPENSER <i>GUSCIO EST.DOSATORE 1813.041.A20 LAV.</i>
	57	 ПІД ЗАМОВЛЕННЯ	12000390	SCREW AUT.TCB 2,9X25 DIN 7981C NIK <i>SCREW AUT.TCB 2,9X25 DIN 7981 C NIK</i>
	58		129825502	TCB SCREW M4X25 UNI 7687 ZNP <i>TCB SCREW M4X25 UNI 7687 ZNP</i>
	59	 ПІД ЗАМОВЛЕННЯ	20007420	MOTOR BRUSH <i>MOTOR BRUSH</i>
	60	 ПІД ЗАМОВЛЕННЯ	11032631	COFFEE GRINDER D.48+DISPENCER220V/60HZ <i>COFFEE GRINDER D.48+DISPENCER 220V/60HZ</i>
	60	 ПІД ЗАМОВЛЕННЯ	11033678	COFFEE GRINDER D.48 + DISPENCER <i>COFFEE GRINDER D.48 + DISPENCER</i>