

Model Machine

MACSAE218

OCS SAE AULIKA TOP HSC SIL 230/50 SCH (10004886)

MACSAE218.T.0001



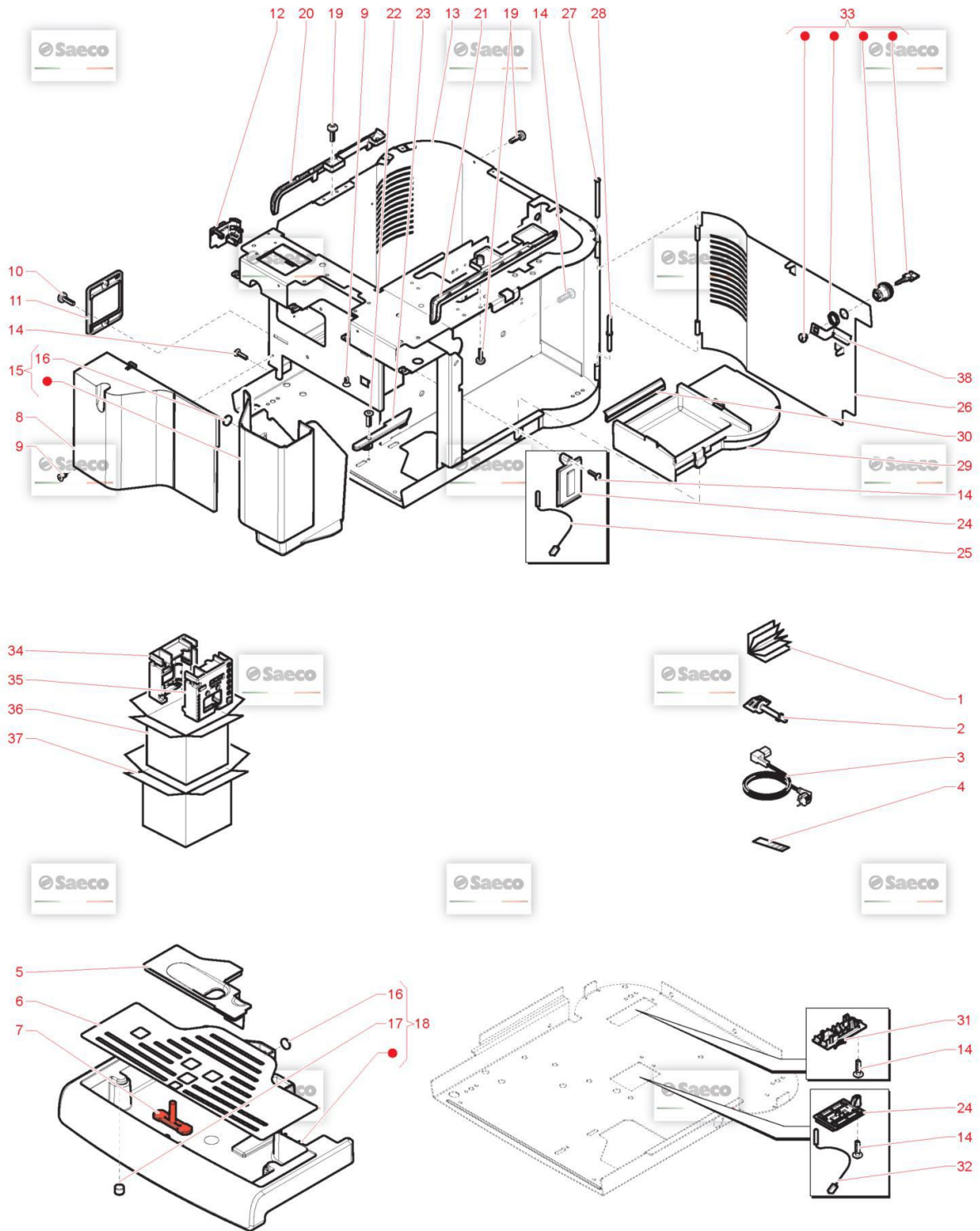









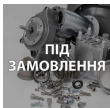

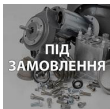

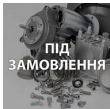

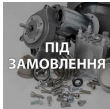

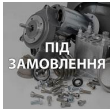

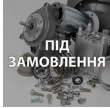

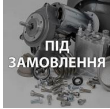
TAVOLA NR. 1 - ARTICOLO OCS SAE AULIKA TOP HSC SIL 230/50 SCH (10004886)

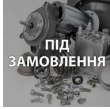

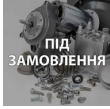
Model Machine

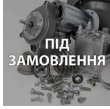
MACSAE218

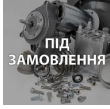

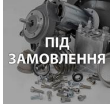







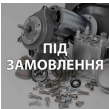





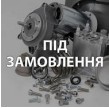



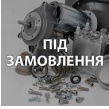



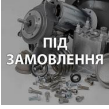

OCS SAE AULIKA TOP HSC SIL 230/50 SCH (10004886)

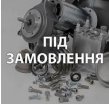
Web	Pos.	Foto	Item - Replace by	Description
				<i>Press - CTRL + CLICK go to item in a new window Натисніть - Ctrl + права кнопка миші щоб відкрити запчастину в новому вікні</i>
	1		15002812	MANUAL SAE SUP040R RYLO GB MANUAL SAE SUP040R RYLO GB
	1		15002813	MANUAL SAE SUP040R RYLO DE MANUAL SAE SUP040R RYLO DE
	1		15002814	MANUAL SAE SUP040R RYLO FR MANUAL SAE SUP040R RYLO FR
	1		15002815	MANUAL SAE SUP040R RYLO ES MANUAL SAE SUP040R RYLO ES
	1		15003775	MANUAL SAE SUP040R RYLO BRA MANUAL SAE SUP040R RYLO BRA
	1		15003906	MANUAL SAE SUP040R RYLO TWN MANUAL SAE SUP040R RYLO TWN
	1		15003907	MANUAL SAE SUP040R RYLO KOR MANUAL SAE SUP040R RYLO KOR
	1		15003908	MANUAL SAE SUP040R RYLO CHN MANUAL SAE SUP040R RYLO CHN
	1		15003922	MANUAL SAE SUP040R RYLO RI 17LANG. MANUAL SAE SUP040R RYLO RI 17LANG.
	1		421946027031	MANUAL WPM SUP040R RYLO/T CHN MANUAL WPM SUP040R RYLO/T CHN
	2		17000736	RED KEY FOR SAFETY MICRO RYLO RED KEY FOR SAFETY MICRO RYLO
	3		13001328	WHITE EXTERNAL BOX RYLO SAE WHITE EXTERNAL BOX RYLO SAE

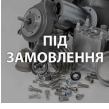
Model Machine

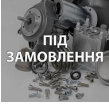
MACSAE218

























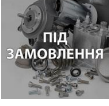

OCS SAE AULIKA TOP HSC SIL 230/50 SCH (10004886)

	3		421944052301	WHT EXTERNAL BOX RYLO WPM <i>WHT EXTERNAL BOX RYLO WPM</i>
	4		17001988	STEEL CASING DOOR LOCK BRACKETRYLO <i>STEEL CASING DOOR LOCK BRACKET RYLO</i>
	5		0301.961	STICKER FOR WATER HARDNESS TEST <i>TEST DUREZZA ACQUA</i>
	6		17000779	BLACK STEAM TUBE PROTECTION RYL <i>BLACK STEAM TUBE PROTECTION RYL</i>
	7		11001985	BLACK POWER CABLE KOREA L=1200 <i>BLACK POWER CABLE KOREA L=1200</i>
	7		11004246	BLACK POWER CABLE TAIWAN HVCTFL=1200 <i>BLACK POWER CABLE TAIWAN HVCTF L=1200</i>
	7		11004247	BLACK POWER CABLE RVV 3X1 CHINA L=1200 <i>BLACK POWER CABLE RVV 3X1 CHINA L=1200</i>
	7		17800019	BLACK POWER CABLE BRAZIL L=1200 <i>BLACK POWER CABLE BRAZIL L=1200</i>
	7		183911050	ЧОРНИЙ КАБЕЛЬ SCHUKO L=1200 SAECO <i>BLACK POWER CABLE SCHUKO L=1200</i>
	7		183940650	BLACK POWER CABLE AUSTRALIA L=1200 <i>BLACK POWER CABLE AUSTRALIA L=1200</i>
	7		NE01.093	CABLE ARGENTINA + PLUG EN60320C13 <i>CABLE ARGENTINA + PLUG EN60320 C13</i>
	8		17000828	BLACK CASING BOTTOM PLUG RYLO <i>BLACK CASING BOTTOM PLUG RYLO</i>
	9		12000895	SCREW TSP TORX 10 3X10 PLAST.SS <i>SCREW TSP TORX 10 3X10 PLAST.SS</i>
	10		13001327	HAVANA BOX RYLO SAE AULIKA <i>HAVANA BOX RYLO SAE AULIKA</i>

Model Machine

MACSAE218















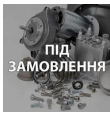



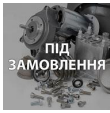



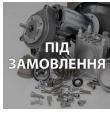

OCS SAE AULIKA TOP HSC SIL 230/50 SCH (10004886)

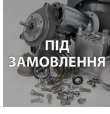
	11		11030098	CRC FRONT CASING COVER RYL/T <i>CRC FRONT CASING COVER RYL/T</i>
	11		421944011851	TXO/BLK FRONT CASING COVER RYL/T <i>TXO/BLK FRONT CASING COVER RYL/T</i>
	12		11025857	BLACK STEEL CASING RYLO/T ASSY. <i>BLACK STEEL CASING RYLO/T ASSY.</i>
	13		17002048	GREY CASING LEFT CLOSING INSERT RYLO/T <i>GREY CASING LEFT CLOSING INSERT V2 RYL</i>
	13		421941301161	BLK CASING LEFT CLOSING INSERTRYLO/T <i>BLK CASING LEFT CLOSING INSERTRYLO/T</i>
	14		11030103	CRC FRONT PANEL RYLO <i>CRC FRONT PANEL RYLO</i>
	15		421946004691	3P.CONN.DUMP BOX REED SENS.V2RYLO UL AS <i>3P.CONN.DUMP BOX REED SENS.V2 RYLO UL AS</i>
	16		13001518	PS-E LEFT INSERT FOR BOX RYLO <i>PS-E LEFT INSERT FOR BOX RYLO</i>
	17		13001517	PS-E RIGHT INSERT FOR BOX RYLO <i>PS-E RIGHT INSERT FOR BOX RYLO</i>
	18		11029624	CRC DUMP BOX RYLO ASSY. <i>CRC DUMP BOX RYLO ASSY.</i>
	18		421944010831	TXO/BLK DUMP BOX RYLO ASSY. <i>TXO/BLK DUMP BOX RYLO ASSY.</i>
	19		12001902	LOCK MERONI 337 <i>LOCK MERONI 337</i>
	20		129535721	SCREW TSP TORX 10 AB 3,5X9,5 SHEET SS <i>SCREW TSP TORX 10 AB 3,5X9,5 SHEET SS</i>
	21		17000829	BLACK BEAN CONTAINER SENSOR SUPPORT RYLO <i>BLACK BEAN CONTAINER SENSOR SUPPORT RYLO</i>

Model Machine

MACSAE218

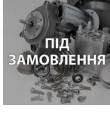











OCS SAE AULIKA TOP HSC SIL 230/50 SCH (10004886)

	22		0301.041.150	GREY BREW UNIT SUPPORT PLATE ROYAL <i>PIASTRA SUPPORTO GRUPPO GRIGIO</i>
	23		0301.020	NIK/BRASS PIN FOR DOOR SUPERAUT. <i>NIK/BRASS PIN FOR DOOR SUPERAUT.</i>
	24		17001444	BLACK WATER LEVEL SENSOR SUPPORT RYLO <i>BLACK WATER LEVEL SENSOR SUPPORT RYLO</i>
	25		0301.019	NIK/BRASS PIN FOR DOOR SUPERAUT. <i>NIK/BRASS PIN FOR DOOR SUPERAUT.</i>
	26		11031307	BLACK CASING RIGHT CLOSING INSERT RYL <i>BLACK CASING RIGHT CLOSING INSERT RYL</i>
	26		17001369	GREY CASING RIGHT CLOSING INSERT V2 RYL <i>GREY CASING RIGHT CLOSING INSERT V2 RYL</i>
	27		17000723	GREY DUMP BOX GUIDE RYL <i>GREY DUMP BOX GUIDE RYL</i>
	28		421941306721	ПЛАТА-СЕНСОП РІВНЯ ВОДИ V3 A <i>CPU+SW WATER LEVEL SENSOR V3 ASSY.</i>
	29		17000422	TRANSP.INFRAREDS PLATE RYL <i>TRANSP.INFRAREDS PLATE RYL</i>
	30		12000450	SCREW TCBR TORX 10 3,5X12 PLAST.ZN-N <i>SCREW TCBR TORX 10 3,5X12 PLAST.ZN-N</i>
	31		20007081	SPARES KIT CRC CASING COVER S/SCR.RYLO <i>SPARES KIT CRC CASING COVER S/SCR.RYLO</i>
	31		421940813041	KIT SPARES TXO/BLK CASING COV.S/S.RYLO/T <i>KIT SPARES TXO/BLK CASING COV.S/S.RYLO/T</i>
	32		12001622	SCREW TCB TORX B 3,5X9,5 SCHEET NIK <i>SCREW TCB TORX B 3,5X9,5 SCHEET NIK</i>

Model Machine

MACSAE218

OCS SAE AULIKA TOP HSC SIL 230/50 SCH (10004886)

	33		17800442	2POLES CONNECT.SENSOR REED DUMP BOX CST <i>2POLES CONNECT.SENSOR REED DUMP BOX CST</i>
	34		11025819	BLACK CASING DOOR RYL ASSY. <i>BLACK CASING DOOR RYL ASSY.</i>
	35		17000240	GREY MOUNTING PLATE INSERT RYL <i>GREY MOUNTING PLATE INSERT RYL</i>
	37		11028379	PSA KLUBER TRIBOSTAR SIL TUBE5GR. <i>PSA KLUBER TRIBOSTAR SIL 2 TUBE 5GR.</i>
	37		421946017941	KLUBERLUB NH1 11-222 TUBE 5GR. <i>PSA KLUBER TRIBOSTAR SIL 2 TUBE 5GR.</i>
	38		421941305141	CRC CAPP.TUBE FRONT.SUPPORT RYLO/T <i>CRC CAPP.TUBE FRONT.SUPPORT RYLO/T</i>

Model Machine

MACSAE218

OCS SAE AULIKA TOP HSC SIL 230/50 SCH (10004886)

MACSAE218.T.0002

TAVOLA NR. 2 - ARTICOLO OCS SAE AULIKA TOP HSC SIL 230/50 SCH (10004886)

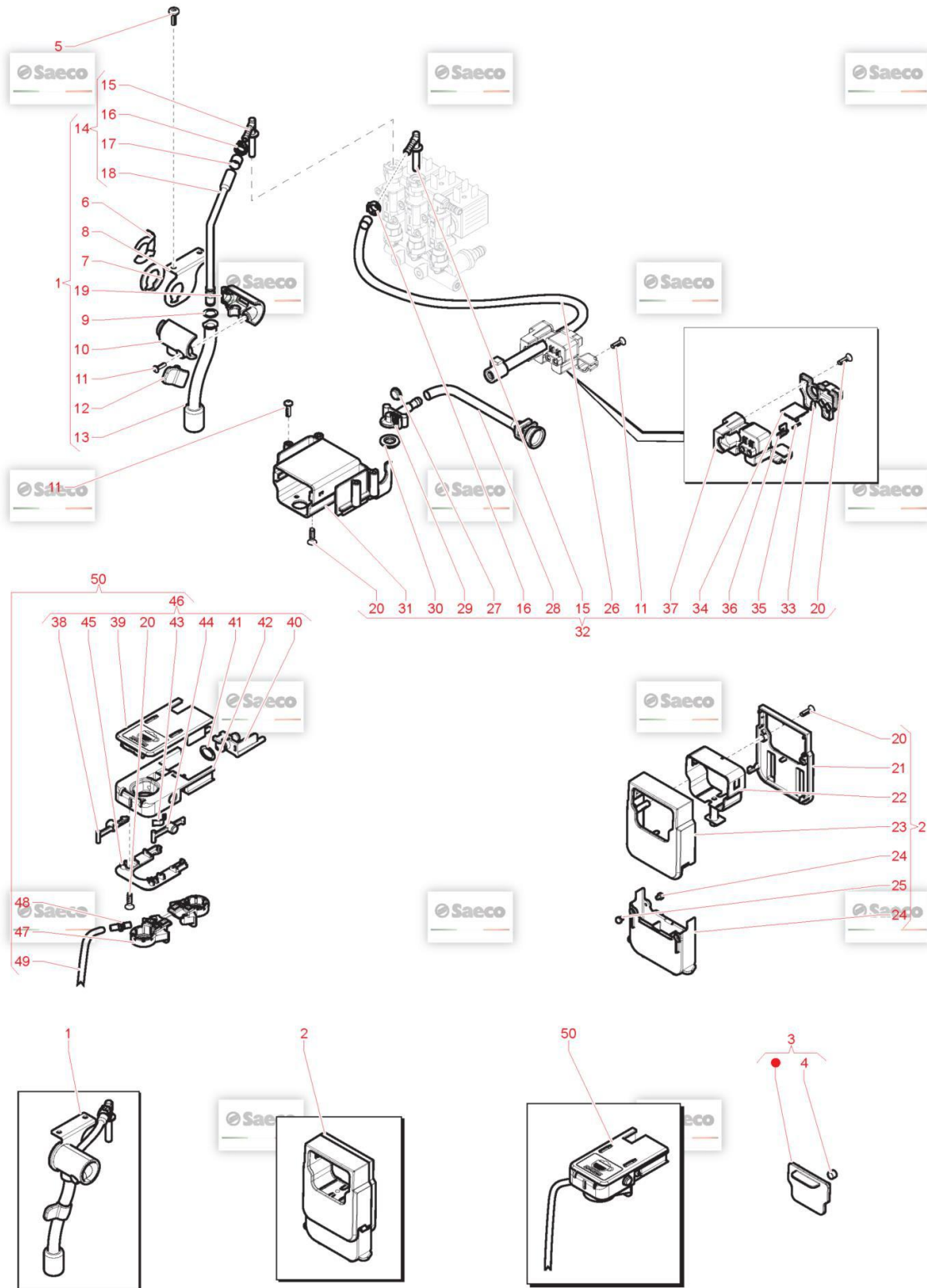

Model Machine

MACSAE218

OCS SAE AULIKA TOP HSC SIL 230/50 SCH (10004886)

Web Pos. Foto Item - Replace by Description



Press - CTRL + CLICK go to item in a new window

Натисніть - Ctrl + права кнопка миші щоб відкрити запчастину в новому вікні



1

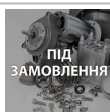

11030104

CRC FRONT COF.DISP.COVER RYL/TASSY.
CRC FRONT COF.DISP.COVER RYL/T ASSY.



2



11025756

GLOSS/SPEC.FRONT COF.DISPENSERCOVER RYL
GLOSS/SPEC.FRONT COF.DISPENSER COVER RYL



3

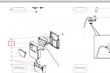

17000251

BLACK INNER BODY COFFEE DISPENS.RYL
BLACK INNER BODY COFFEE DISPENS.RYL



4

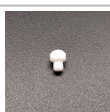

11013085

WHITE COFFEE DISPENSER SLIDERMYB9
WHITE COFFEE DISPENSER SLIDER MYB9



5



17000246

ЧОРНА ЗАГЛУШКА ЧАСТИНИ КАВОВОГО ДІСПЕНСОРА
BLACK EXT.MOBILE PART COF.DISPENSER RYL



6



17000248

BLACK REAR COVER COFFEE DISPENSER RYL
BLACK REAR COVER COFFEE DISPENSER RYL



7



140321961

ПРОКЛАДКА O-RING ДЛЯ КАВОМАШИНИ SAECO 2031 TERMOIL
OR 2031 IN TERMOIL



8

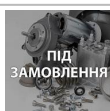

11029670

TF/CHROM.STEAM TUBE RYLO
TF/CHROM.STEAM TUBE RYLO



9

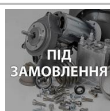

17000672

BLACK REAR STEAM TUBE SUPPORTRYL
BLACK REAR STEAM TUBE SUPPORT RYL



10

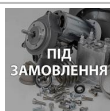

17001437

BLACK FRONT STEAM TUBE SUPPORTRYL
BLACK FRONT STEAM TUBE SUPPORT RYL



11

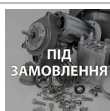

17000815

STEEL STEAM TUBE SUPPORT BRACKET RYL
STEEL STEAM TUBE SUPPORT PLATE RYL



12



11001624

BLACK STEAM TUBE WASHER P0049
BLACK STEAM TUBE WASHER P0049



13















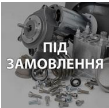













NF11.084

PHOSPH/STEEL FOLK SPRING
PHOSPH/STEEL FOLK SPRING

Model Machine

MACSAE218























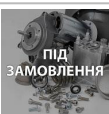

OCS SAE AULIKA TOP HSC SIL 230/50 SCH (10004886)

	14		11031415	TF/CHR.TEA/BRASS STEAM TUBE V2RYLO ASSY TF/CHR.TEA/BRASS STEAM TUBE V2 RYLO ASSY
	15		11030101	CRC COFFEE DISPENSER RYL ASSY. AS.EROG.CAF.RYL CRC
	16		17000390	НИЖНЯ СТІНКА КАПУЧИНАТОРА SAECO BLACK LOWER CAPPUCINATORE LID RYL
	17		17000336	MILK INTAKE TUBE CONNECTOR RYL MILK INTAKE TUBE CONNECTOR RYL
	18		17000389	ЛІВА ЗАЦІПКА КАПУЧИНАТОРА GREY LEFT CAPPUCINATORE INSERT RYL
	19		17000382	SS CAPPUCINATORE INSERT SPRING RYL SS CAPPUCINATORE INSERT SPRING RYL
	20		17000402	GREY RIGHT CAPPUCINATORE INSERT RYL GREY RIGHT CAPPUCINATORE INSERT RYL
	21		11029672	SILICONE TUBE 3,5X6 L=500 MM SILICONE TUBE 3,5X6 L=500 MM
	22		17000338	BLACK LEFT ENTRY CAPPUCINAT.CASING RYL BLACK LEFT ENTRY CAPPUCINAT.CASING RYL
	23		11030240	BLK UPPER CAPPUC.LID LASER-S/SCR.RYL BLK UPPER CAPPUC.LID LASER-S/SCR.RYL
	24		17000785	BLACK CAPPUC.INPUT MILK CONNECTOR RYL BLACK CAPPUCINATORE MILK CONNECTOR RYL
	25		NM01.028	O-RING 106 SILICONE OR 106 SILICONE
	26		17000257	BLACK.COFFEE DISPENSER SUPPORTRYL BLACK.COFFEE DISPENSER SUPPORT RYL
	27		11029671	BLACK CAPPUCINATORE S/SCR.O ASSY. AS.CAPPUC.RYLO NER.SER.

Model Machine

MACSAE218

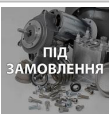













OCS SAE AULIKA TOP HSC SIL 230/50 SCH (10004886)

	28		17000337	BLACK SEAL FOR COFFEE DISPENSER RYL <i>BLACK SEAL FOR COFFEE DISPENSER RYL</i>
	29		17000616	BLACK COFFEE DISPENSER TUBE RYL <i>BLACK COFFEE DISPENSER TUBE RYL</i>
	30		17000614	BLACK DISPENSER COFF.INLET CONNECT.RYL <i>BLACK DISPENSER COFF.INLET CONNECT.RYL</i>
	31		11014016	SS.INSERT FOR MAGNET MYB9 <i>SS.INSERT FOR MAGNET MYB9</i>
	32		20007031	BLK CAPPUC.OUTPUT STEAM CONNECT.KIT RYL <i>BLK CAPPUC.OUTPUT STEAM CONNECT.KIT RYL</i>
	33		17000486	BLK CAPPUCCIN.OUTPUT MILK CONNECTOR RYL <i>BLK CAPPUCCIN.OUTPUT MILK CONNECTOR RYL</i>
	34		9161.111	MAGNET FOR FLOAT SUPERAUT. <i>MAGNET FOR FLOAT SUPERAUT.</i>
	35		12000450	SCREW TCBR TORX 10 3,5X12 PLAST.ZN-N <i>SCREW TCBR TORX 10 3,5X12 PLAST.ZN-N</i>
	36	 ПІД ЗАМОВЛЕННЯ	17000348	BLK CAPPUCCINATORE BOARD SUPP.COVER RYL <i>BLK CAPPUCCINATORE BOARD SUPP.COVER RYL</i>
	37		11025772	CAPPUCCINATORE BOARD RYL <i>CAPPUCCINATORE BOARD RYL</i>
	38	 ПІД ЗАМОВЛЕННЯ	17000019	SS CARAFE MICRO INSERT SPRINGMYB9 <i>SS CARAFE MICRO INSERT SPRING MYB9</i>
	39	 ПІД ЗАМОВЛЕННЯ	17000421	BLACK CAPPUCCINATORE PRESENCEINSERT RYL <i>BLACK CAPPUCCINATORE PRESENCE INSERT RYL</i>
	40	 ПІД ЗАМОВЛЕННЯ	17000339	BLACK CAPPUCCINATORE BOARD SUPPORT RYL <i>BLACK CAPPUCCINATORE BOARD SUPPORT RYL</i>

Model Machine

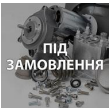
MACSAE218

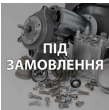
OCS SAE AULIKA TOP HSC SIL 230/50 SCH (10004886)

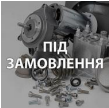
	41		20007030	BLACK OUTPUT STEAM TUBE KIT RYL <i>BLACK OUTPUT STEAM TUBE KIT RYL</i>
	42		17001362	BLK MILK INTAKE TUBE CONNECT.INS.V2 RYL <i>BLK MILK INTAKE TUBE CONNECT.INS.V2 RYL</i>
	43		12001622	SCREW TCB TORX B 3,5X9,5 SCHEET NIK <i>SCREW TCB TORX B 3,5X9,5 SCHEET NIK</i>
	44		12000895	SCREW TSP TORX 10 3X10 PLAST.SS <i>SCREW TSP TORX 10 3X10 PLAST.SS</i>
	45		NF11.052	OETIKER CLIP <i>OETIKER CLIP</i>
	46		11031165	TEA/BRASS CAPPUC/STEAM TUBE CONN.V3 RYL <i>TEA/BRASS CAPPUC/STEAM TUBE CONN.V3 RYL</i>
	47		17001574	BLACK STEAM TUBE HANDGRIP RYLO <i>BLACK STEAM TUBE HANDGRIP RYLO</i>
	48		421941305141	CRC CAPP.TUBE FRONT.SUPPORT RYLO/T <i>CRC CAPP.TUBE FRONT.SUPPORT RYLO/T</i>

Model Machine

MACSAE218

OCS SAE AULIKA TOP HSC SIL 230/50 SCH (10004886)

MACSAE218.T.0003

TAVOLA NR. 3 - ARTICOLO OCS SAE AULIKA TOP HSC SIL 230/50 SCH (10004886)

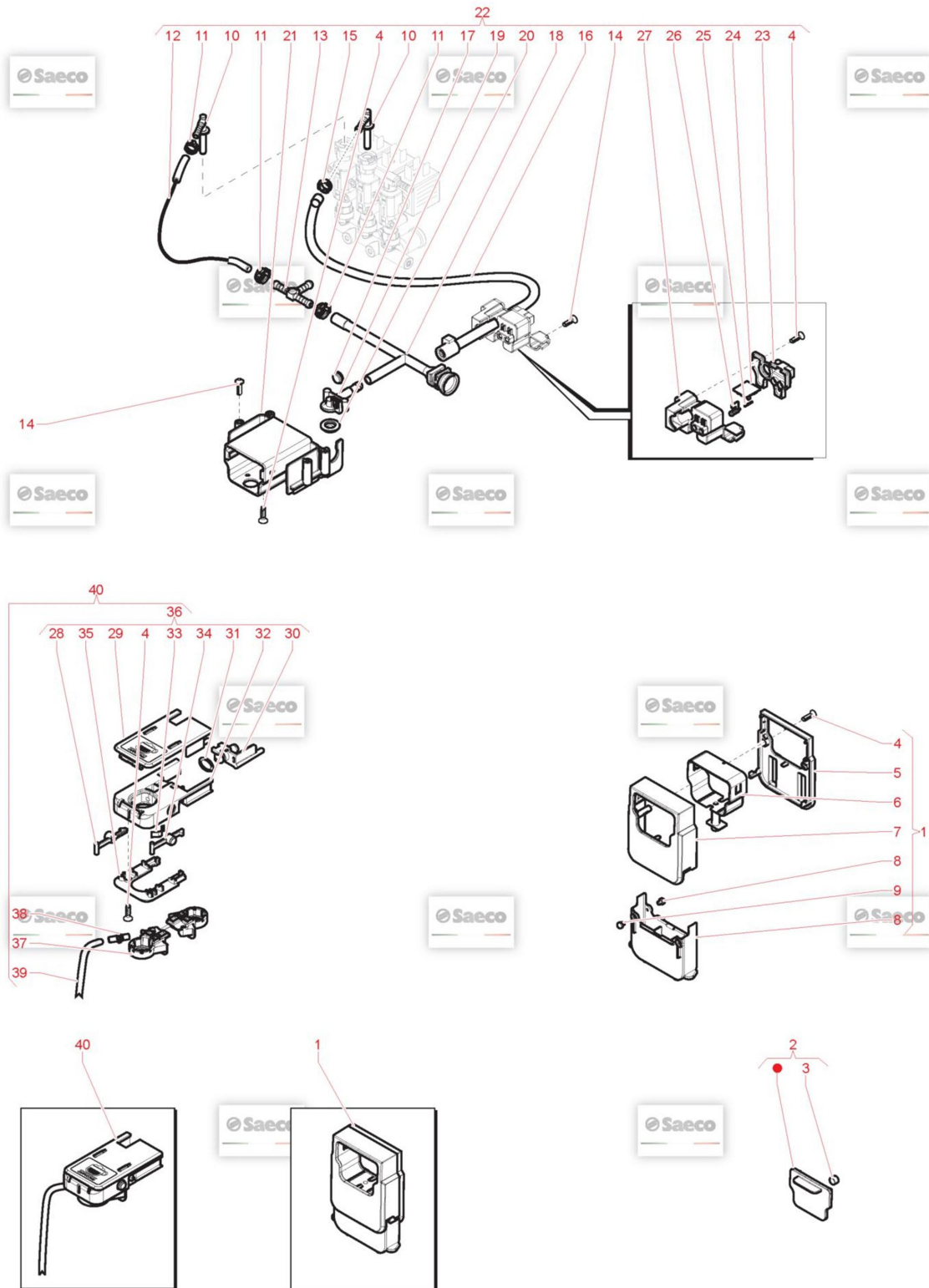

Model Machine

MACSAE218

OCS SAE AULIKA TOP HSC SIL 230/50 SCH (10004886)

Web Pos. Foto Item - Replace by Description



*Press - CTRL + CLICK go to item in a new window
Натисніть - Ctrl + права кнопка миші щоб відкрити запчастину в новому вікні*



1



17000269

СКЛО ДИСПЛЕЯ PHILIPS SAECO 996530068575
TRANSP.GLASS FOR DISPLAY RYL



2



17000259

BLACK DISPLAY INSERT RYL
BLACK DISPLAY INSERT RYL



3



17000271

BLACK DISPLAY SEAL RYL
BLACK DISPLAY SEAL RYL



4



12001779

WHITE DISPLAY 160X80
WHITE DISPLAY 160X80 0355DP RYL



5



11030168

CRC RIGHT LOW.T.PANEL COVER S/SC.RYLO/T
COP.TASTIERA INF.DX RYLO CRC+TRA.SER.



5

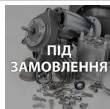

421944011051

TXOBLK RIGHT LOW.T.PAN.COVER S/SC.RYLO/T
TXOBLK RIGHT LOW.T.PAN.COVER S/SC.RYLO/T



6



11030169

CRC LEFT LOW.T.PANEL COVER S/SC.RYLO/T
COP.TASTIERA INF.SX RYLO CRC+TRA.SER.



6

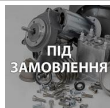

421944011061

TXOBLK LEFT LOW.T.PAN.COVER S/SC.RYLO/T
TXOBLK LEFT LOW.T.PAN.COVER S/SC.RYLO/T



7

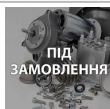

17000831

BLACK LEFT TOUCH PANEL SUPPORT RYLO
BLACK LEFT TOUCH PANEL SUPPORT RYLO



8

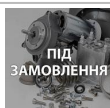

17000830

BLACK RIGHT TOUCH PANEL SUPPORT RYLO
BLACK RIGHT TOUCH PANEL SUPPORT RYLO



9



17000485

TRANSP.LEFT TOUCH PANEL RYLO
TRANSP.LEFT TOUCH PANEL RYLO



10

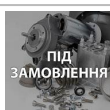

17000484

TRANSP.RIGHT TOUCH PANEL RYLO
TRANSP.RIGHT TOUCH PANEL RYLO



11













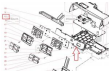

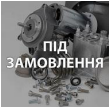



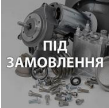







11027084

CPU+SW RYLO ASSY.
CPU+SW RYLO ASSY. AULIKA TOP

Model Machine

MACSAE218

OCS SAE AULIKA TOP HSC SIL 230/50 SCH (1000486)

	12		17000274	BLACK CPU BOARD SUPPORT RYL <i>BLACK CPU BOARD SUPPORT RYL</i>
	13		17000275	BLACK PWR BOARD SUPPORT RYL <i>BLACK PWR BOARD SUPPORT RYL</i>
	14		11030311	PWR BOARD RYLO 230V <i>PWR BOARD RYLO 230V</i>
	14		421941302411	PWR BOARD RYLO 120V <i>PWR BOARD RYLO 120V</i>
	15		17000277	BLACK CPU-PWR BOARDS COVER RYL <i>BLACK CPU-PWR BOARDS COVER RYL</i>
	16		12000450	SCREW TCB TORX 10 3,5X12 PLAST.ZN-N <i>SCREW TCB TORX 10 3,5X12 PLAST.ZN-N</i>
	17		129913202	SCREW TCB TORX 10 3X8 PLAST.ZN-B <i>SCREW TCB TORX 10 3X8 PLAST.ZN-B</i>
	18		17001152	POWER BOARD PROTECTION RYL <i>POWER BOARD PROTECTION RYL</i>
	19		12001622	SCREW TCB TORX B 3,5X9,5 SCHEET NIK <i>SCREW TCB TORX B 3,5X9,5 SCHEET NIK</i>
	20		11025849	CRC RIGHT UPP.T.PANEL COVER S/SC.RYLO/T <i>CRC RIGHT UPPER T.PANEL COVER S/SCR.RYLO</i>
	20		421944011021	TXOBLK RIGHT UPP.T.PAN.COVER S/SC.RYLO/T <i>TXOBLK RIGHT UPP.T.PAN.COVER S/SC.RYLO/T</i>
	21		11025850	CRC LEFT UPP.T.PANEL COVER S/SC.RYLO/T <i>CRC LEFT UPPER T.PANEL COVER S/SCR.RYLO</i>
	21		421944011041	TXOBLK LEFT UPP.T.PAN.COVER S/SC.RYLO/T <i>TXOBLK LEFT UPP.T.PAN.COVER S/SC.RYLO/T</i>

Model Machine

MACSAE218

OCS SAE AULIKA TOP HSC SIL 230/50 SCH (10004886)

MACSAE218.T.0004



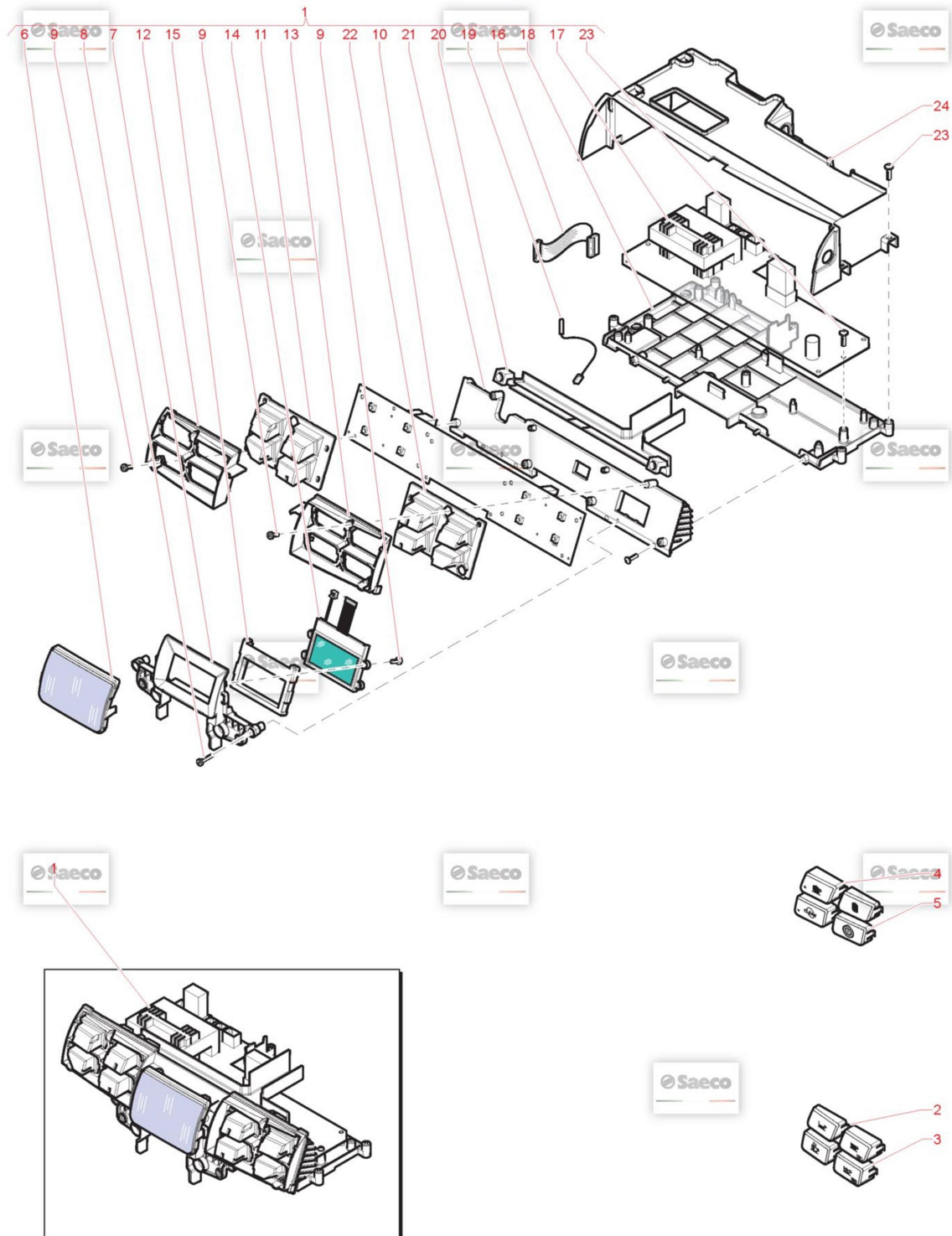























TAVOLA NR. 4 - ARTICOLO OCS SAE AULIKA TOP HSC SIL 230/50 SCH (10004886)

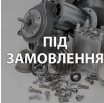

Model Machine

MACSAE218

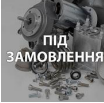















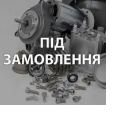

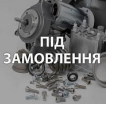

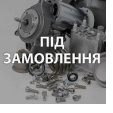





OCS SAE AULIKA TOP HSC SIL 230/50 SCH (10004886)

Web	Pos.	Foto	Item - Replace by	Description
				<i>Press - CTRL + CLICK go to item in a new window Натисніть - Ctrl + права кнопка миші щоб відкрити запчастину в новому вікні</i>
	1		11031414	TEA/BRASS ELECTROV.V3 24V RYL/T ASSY. PHILIPS SAECO 996530073228 TEA/BRASS ELECTROV.V3 24V RYL/T ASSY.
	2		17001178	BLK EV 1/8"GAS.CONNECTOR V2 INSERT RYL BLK EV 1/8 GAS.CONNECTOR V2 INSERT RYL
	3		17001909	RED EV CONNECTOR 1/8"GAS SEALV2 RYL RED EV CONNECTOR 1/8 GAS SEAL V2 RYL
	4		11027334	3'ЄДНАННЯ 1/8"GAS V2 RYL TEA/BRASS ELECTROV.CONNECT1/8"GAS V2 RYL
	5		17001262	LFBASS 2W.EV 21JN1R4V20-X031 LFBASS 2W.EV 21JN1RRV20-X005+LBV05024CU
	6		11024469	L-F/BRASS CONNECTOR FOR BOILERAURA L-F/BRASS CONNECTOR FOR BOILER AURA
	7		17000428	STEEL CONNECTORS FIXING PLATERYL STEEL CONNECTORS FIXING PLATE RYL
	8		17000168	BLACK ELECTROV/CONNECTOR SUPP.RYL BLACK ELECTROV/CONNECTOR SUPP.RYL
	9		U043.012	SCREW TCB TORX 20 M4X6 ZN-B VITE TCBC M4,0X6 UNI 7687 Z
	10		17001908	BRASS 4WAYS CONNECT+SAFETY VALVE V3 RYL BRASS 4WAYS CONNECT+SAFETY VALVE V3 RYL
	11		17000166	STEEL STEAM TUBOL.BOILER SUPPORT RYL STEEL STEAM TUBOL.BOILER SUPPORT RYL
	12		12001715	SCREW TCB TORX 20 M4X8 AUTOFORMING ZN-B SCREW TCB TORX 20 M4X8 AUTOFORMING ZN-B
	13		12001622	SCREW TCB TORX B 3,5X9,5 SCHEET NIK SCREW TCB TORX B 3,5X9,5 SCHEET NIK

Model Machine

MACSAE218























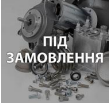

OCS SAE AULIKA TOP HSC SIL 230/50 SCH (10004886)

	14		11025744	TEA/BRASS HOT WATER PIN RYL ASSY. <i>TEA/BRASS HOT WATER PIN RYL ASSY.</i>
	15		147756562	BLK PROTECTION FOR FOLK SPRINGTUBE D=4 <i>BLK PROTECTION FOR FOLK SPRING TUBE D=4</i>
	16		11025742	BLOWDOWN VALVE V3 RYL 230V ASSY. <i>BLOWDOWN VALVE V3 RYL 230V ASSY.</i>
	16		11028161	BLOWDOWN VALVE V3 RYL 220V-60HZ ASSY. <i>BLOWDOWN VALVE V3 RYL 220V-60HZ ASSY.</i>
	16		11028187	BLOWDOWN VALVE V3 RYL 120V ASSY. <i>BLOWDOWN VALVE V3 RYL 120V ASSY.</i>
	17		129912104	SCREW TCBR TORX 20 4X10 PLAST.ZN-N <i>SCREW TCBR TORX 20 4X10 PLAST.ZN-N</i>
	18		17000821	BLACK TURBINE SUPPORT RYLO <i>BLACK TURBINE SUPPORT RYLO</i>
	19		17001358	BLK WATER CONT/FLOWMETER 90°CONNECT.RYLO <i>BLK WATER CONT/FLOWMETER 90°CONNECT.RYLO</i>
	20		140326662	OR ORM 0040-20 SILICONE <i>OR METRIC 0040-20 IN SILICONE</i>
	21		11026413	TEA/BRASS HOT WATER PIN PLUG RYL <i>TEA/BRASS HOT WATER PIN PLUG RYL</i>
	22		9011.132	SS SPRING FOR PIN <i>MOLLA X SPILLO</i>
	23		9161.434	HOT WATER PIN <i>PERNO CALDAIA MAGIC,ROYAL SAECO</i>
	24		9011.144	SS FORK FOR TUBE D=4 <i>FORCELLA X TUBO D.4</i>
	25		NM01.035	OR ORM 0090-20 SILICONE <i>OR ORM 0090-20 SILICONE</i>

Model Machine

MACSAE218











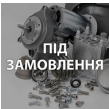





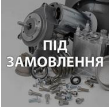

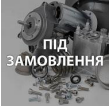

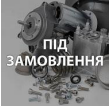



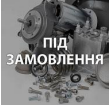

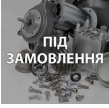
OCS SAE AULIKA TOP HSC SIL 230/50 SCH (10004886)

	26		NM01.057	OR ORM 0050-20 IN SILICONE <i>OR ORM 0050-20 IN SILICONE</i>
	27		11009013	TEA/BRASS PIN FOR PISTON L=10 <i>TEA/BRASS PIN FOR PISTON L=10</i>
	28		11009012	TEA/BRASS BOILER PIN BUSH <i>TEA/BRASS BOILER PIN BUSH</i>
	29		11009019	TEA/BRASS PISTON L=20,9 ASSY. <i>TEA/BRASS PISTON L=20,9 ASSY.</i>
	30		11005099	NATURAL CURSOR V2 FOR BOILER P119 <i>NATURAL CURSOR V2 FOR BOILER P119</i>
	31		129913902	SCREW TCB TORX 10 3X12 PLAST.ZN-B <i>SCREW TCB TORX 10 3X12 PLAST.ZN-B</i>
	32		11023282	BLACK SLIM TUB.BOILERS SUPPORTMYB9 <i>BLACK SLIM TUB.BOILERS SUPPORT MYB9</i>
	33		129573402	SCREW TAPT M4X10 DIN 7985 GALV <i>SCREW TAPT M4X10 DIN 7985 GALV</i>
	34		11013735	SLIM TUB.BOILER 1300W 230V ASSY. <i>SLIM TUB.BOILER 1300W 230V ASSY. NUOVO PREZZO 13,3</i>
	34		11023153	SLIM TUB.BOILER 1300W 120V ASSY. <i>SLIM TUB.BOILER 1300W 120V ASSY.</i>
	35		190800100	ТЕМПЕРАТУРНИЙ СЕНСОП NTC UL L=280MM <i>TEMPERATURE SENSOR NTC UL L=280MM</i>
	36		12001369	SCREW TSP TORX 10 5X35 PLAST.SS <i>SCREW TSP TORX 10 5X35 PLAST.SS</i>
	37		12001033	ТЕРМОСТАТ 190°С БОЙЛЕРА ДЛЯ КОФЕВАРОК PHILIPS SAECO 12001033 <i>THERMOSTAT ONE SHOT 190°</i>

Model Machine

MACSAE218

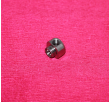









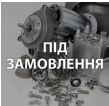

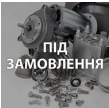













OCS SAE AULIKA TOP HSC SIL 230/50 SCH (10004886)

	38		11001751	TUB.BOILER V3 UPPER THERM.FIXING SPRING <i>TUB.BOILER V3 UPPER THERM.FIXING SPRING</i>
	39		128310402	GALV.WASHER UNI 8842 A4 <i>GALV.WASHER UNI 8842 A4</i>
	40		124390520	BRASS BENT FASTON 45° 6,3X0,8 <i>BRASS BENT FASTON 45° 6,3X0,8</i>
	41		17000471	BLACK BOILER ANTIVIBRATION RYL <i>BLACK BOILER ANTIVIBRATION RYL</i>
	42		11029554	BLACK/SBD ULKA MF PUMP SUPPORT <i>BLACK/SBD ULKA MF PUMP SUPPORT</i>
	43		16000540	TRANSPAR.11X12,8 SILICONE TUBEIN ROLL <i>TRANSPAR.11X12,8 SILICONE TUBE IN ROLL</i>
	44		12001212	ULKA PUMP MF 230V-50HZ <i>ULKA PUMP MF 230V-50HZ</i>
	44		12001346	ULKA PUMP MF 120V-60HZ <i>POMPA ULKA MF 120V-60HZ</i>
	44		12001348	ULKA PUMP MF 220V-50/60HZ <i>ULKA PUMP MF 220V-50/60HZ</i>
	45		17800203	ДВОПОЛЮСОВИЙ ДАТЧИК ПЕРЕГРІВУ ПОМПИ ВЗБОРІ PHILIPS SAECO ... <i>2POLES CONNECTOR STEAM PUMP RYL UL</i>
	46		11001054	СОЕДИНИТЕЛЬНЫЙ УГОЛОК 90° К НАСОСУ P0049/B PHILIPS SAECO 996... <i>BLK PUMP OUTLET 90° CONNECTOR P0049/B</i>
	47		11022857	BLACK PUMP SUPPORT GMYB <i>BLACK PUMP SUPPORT GMYB</i>
	48		9181.350	TEA/BRASS REAR CONNECTOR 1/8"ULKA PUMP <i>TEA/BRASS REAR CONNECTOR 1/8 ULKA PUMP</i>
	49		12000131	ULKA PUMP EP5/S 120V-60HZ <i>ULKA PUMP EP5/S 120V-60HZ</i>

Model Machine

MACSAE218













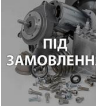







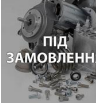



OCS SAE AULIKA TOP HSC SIL 230/50 SCH (10004886)

	49		12000140	PUMP 230V-50HZ <i>ULKA PUMP EP5/S GW 230V-50HZ</i>
	49		12000182	ULKA PUMP EP5/S GW 220V-60HZ <i>ULKA PUMP EP5/S GW 220V-60HZ</i>
	49		421941305991	ULKA PUMP EP5FMGW 230V-50HZ <i>ULKA PUMP EP5FMGW 230V-50HZ</i>
	50		17800202	2POLES CONNECTOR COFFEE PUMP RYL UL <i>2POLES CONNECTOR COFFEE PUMP RYL UL</i>
	51		17000163	STEEL COFFEE TUBOL.BOILER SUPPORT RYL/T <i>STEEL COFFEE TUBOL.BOILER SUPPORT RYL</i>
	52		NE03.038	BIPOLAR SWITCH FUSIT C1250AR <i>BIPOLAR SWITCH FUSIT C1250AR</i>
	53		12001883	CUP SOCKET V3 EN 60320 C 13 <i>CUP SOCKET V3 EN 60320 C 13</i>
	54		11028204	BLACK SOCKET-SWITCH SUPPORT RYL UL <i>BLACK SOCKET-SWITCH SUPPORT RYL UL</i>
	54		17000162	BLACK SOCKET-SWITCH SUPPORT RYL <i>BLACK SOCKET-SWITCH SUPPORT RYL</i>
	55		17000973	BLACK COMPONENTS SUPPORT RYLO <i>BLACK COMPONENTS SUPPORT RYLO</i>
	56		17000165	BLACK DRIP TRAY PROTECTION RYL <i>BLACK DRIP TRAY PROTECTION RYL</i>
	57		12000450	SCREW TCBR TORX 10 3,5X12 PLAST.ZN-N <i>SCREW TCBR TORX 10 3,5X12 PLAST.ZN-N</i>
	58		11003555	GALVANIZED SELF-TAPPING SCREW4,8X32 <i>GALVANIZED SELF-TAPPING SCREW 4,8X32</i>
	59		128310521	WASHER UNI 8842 A5 SS <i>WASHER UNI 8842 A5 SS</i>

Model Machine

MACSAE218

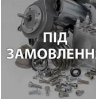









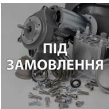







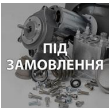

OCS SAE AULIKA TOP HSC SIL 230/50 SCH (10004886)

	60		17000156	BLACK HOT WATER PIN SUPPORT RYL <i>BLACK HOT WATER PIN SUPPORT RYL</i>
	61		140328059	OR 2015 SILICONE PTFE/FDA <i>OR 2015 SILICONE PTFE/FDA</i>
	62		11000750	TEA/BRASS CONNECTOR FOR SILICONE TUBE <i>TEA/BRASS CONNECTOR FOR SILICONE TUBE</i>
	63		12000892	ЗАЖИМ D.9,5 16700004 <i>OETIKER CLAMP D=9,5 16700004 (L250)</i>
	64		NV99.033	ПЛАСТИКОВА ТУРБИНА ВИСОКОГО ТИСКУ <i>TURBINA DIGMESA IN PLASTICA</i>
	65		421946001561	6P.CONN.FLOWMETER V2 RYLO UL ASSY. <i>6P.CONN.FLOWMETER V2 RYLO UL ASSY.</i>
	66		12001595	TRANSP/WHITE ASPIRATION FILTERMDS <i>TRANSP/WHITE ASPIRATION FILTER MDS</i>
	67		147920300	TRANS.CONNECTOR D=8 ART.80.26.047 KA.461 <i>RACCORDO T D=8 ART.80.26.047 KA.461</i>
	68		184320200	SPRING HOSE CLAMP D=9,5MM <i>MOLLA STRINGITUBO D=9,5MM</i>
	69		16000380	5X8,9 SILICONE TUBE IN ROLL <i>5X8,9 SILICONE TUBE IN ROLL</i>
	70		JS01.022	SILICONE TUBE 5X10 60SH IN ROLL <i>SILICONE TUBE 5X10 60SH IN ROLL</i>
	71		12001812	TRANSP.CROSS CONNECTOR D=8 RYLO <i>TRANSP.CROSS CONNECTOR D=8 RYLO</i>
	72		11006304	TEA/BRASS CONNECTOR FOR ALUM.BOILER <i>TEA/BRASS CONNECTOR FOR ALUM.BOILER</i>

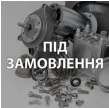
Model Machine

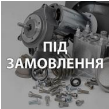
MACSAE218

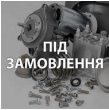
OCS SAE AULIKA TOP HSC SIL 230/50 SCH (10004886)

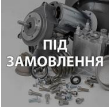
	73		9181.406	TEA/BRASS CONNECTOR TURBINE MF1/4 1/8 <i>TEA/BRASS CONNECTOR TURBINE MF 1/4 1/8</i>
	74		11010243	TEA/BRASS 90° DOUBLE CONNECTOR <i>TEA/BRASS 90° DOUBLE CONNECTOR</i>
	75		NM01.049	OR ORM 0070-20 SILICONE <i>OR ORM 0070-20 SILICONE</i>
	76		147920150	90° INLET PUMP CONNECTOR <i>RACCORDO A 90° IN SANTOPRENE</i>
	77		140321961	ПРОКЛАДКА O-RING ДЛЯ КАВОМАШИНИ SAECO 2031 TERMOIL <i>OR 2031 IN TERMOIL</i>
	78		0701.081	SPRING FOR TUBE PRODUCT 1 <i>SPRING FOR TUBE PRODUCT 1</i>
	79		17800442	2POLES CONNECT.SENSOR REED DUMP BOX CST <i>2POLES CONNECT.SENSOR REED DUMP BOX CST</i>
	10001		11025705	COFFEE TUB.BOILER 230V RYL/T ASSY. <i>COFFEE TUB.BOILER 230V RYL/T ASSY.</i>
	10001		11025706	STEAM TUB.BOILER 230V RYL ASSY. <i>STEAM TUB.BOILER 230V RYL ASSY.</i>
	10001		11028182	COFFEE TUB.BOILER 120V RYL/T ASSY. <i>COFFEE TUB.BOILER 120V RYL/T ASSY.</i>
	10001		11028183	STEAM TUB.BOILER 120V RYL ASSY. <i>STEAM TUB.BOILER 120V RYL ASSY.</i>

Model Machine

MACSAE218

OCS SAE AULIKA TOP HSC SIL 230/50 SCH (10004886)

MACSAE218.T.0005



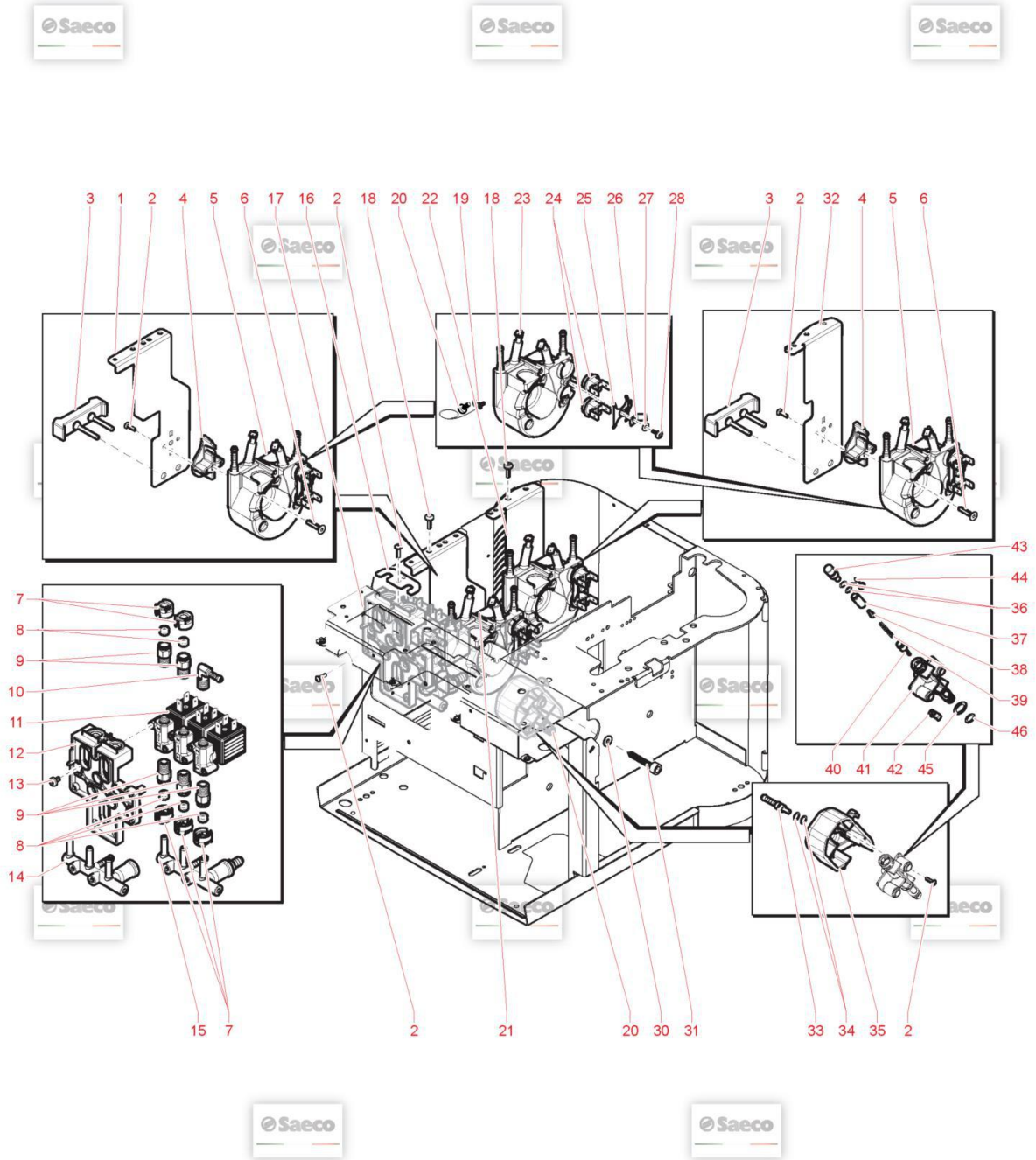























TAVOLA NR. 5 - ARTICOLO OCS SAE AULIKA TOP HSC SIL 230/50 SCH (10004886)



Model Machine

MACSAE218













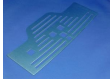











OCS SAE AULIKA TOP HSC SIL 230/50 SCH (10004886)

Web	Pos.	Foto	Item - Replace by	Description
				<i>Press - CTRL + CLICK go to item in a new window Натисніть - Ctrl + права кнопка миші щоб відкрити запчастину в новому вікні</i>
	1		11025848	BLACK WATER CONTAINER LID RYLO <i>COPERCHIO.CONTENTITORE.ACQUA.NERO LID RYLO</i>
	2		11025847	BLACK HANDLE WATER CONTAINER LID RYLO <i>BLACK HANDLE WATER CONTAINER LID RYLO</i>
	3		224640200	БІЛИЙ ПЛАСТИКОВИЙ ФІЛЬТР У КОНТЕЙНЕР ВОДИ SAECO 996530029115 <i>EXTERNAL FILTER FOR WATER CONTAINER ASSY</i>
	4		140328461	ПРОКЛАДКА O-RING 0190-10 ДЛЯ КОФЕМАШИНЫ PHILIPS SAECO 99653... <i>OR METRICO 0190-10 IN EPDM NUOVO PREZZO 0,13</i>
	5		11025846	TRANSP/GREY WATER CONTAINER RYLO ASSY. <i>NAT/GREY WATER CONTAINER RYLO ASSY.</i>
	6		140324362	OR ORM 0060-30 SILICONE <i>OR METRIC 0060-30 IN SILICONE</i>
	7		126764718	SS WATER CONTAINER VALVE SPRING <i>SS WATER CONTAINER VALVE SPRING</i>
	8		147660562	GREY PISTON FOR WATER CONTAINER VALVE <i>GREY PISTON FOR WATER CONTAINER VALVE</i>
	9		0701.031.150	GREY WATER VALVE GACO DIM 14 SEAL COVER <i>SEAL COVER GREY</i>
	10		145842900	NBR WATER CONT.VALVE GACO DIM14 SEAL <i>NBR WATER CONT.VALVE GACO DIM14 SEAL</i>
	11		12000895	SCREW TSP TORX 10 3X10 PLAST.SS <i>SCREW TSP TORX 10 3X10 PLAST.SS</i>
	12		0701.014.150	GREY WATER VALVE GACO DIM 14 SEAL CONT. <i>GREY WATER VALVE GACO DIM 14 SEAL CONT.</i>
	13		140320461	OR ORM 0080-20 TERMOIL <i>OR ORM 0080-20 IN TERMOIL</i>

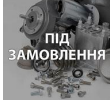
Model Machine

MACSAE218

OCS SAE AULIKA TOP HSC SIL 230/50 SCH (10004886)

	14		12001902	LOCK MERONI 337 <i>LOCK MERONI 337</i>
	15		11029899	SB/SS DRIP TRAY GRATE RYL/T <i>SB/SS DRIP TRAY GRATE RYL</i>
	16		17000991	RED FLOAT V2 FOR DRIP TRAY RYL <i>RED FLOAT V2 FOR DRIP TRAY RYL</i>
	17		11030099	CRC DRIP TRAY RYL ASSY. <i>AS.VASCA REC.ACQ.RYL VERN.CRC</i>
	17		11031093	TXO/BLK DRIP TRAY RYL ASSY. <i>AS.VASCA REC.ACQ.RYL VERN.NER/TXO</i>
	18		11025841	TRANSP/GREY BEAN CONTAINER RYLO <i>NAT/GREY BEAN CONTAINER RYLO</i>
	19		11025844	BLACK BEAN COFFEE CONTAIN.LID RYLO ASSY. <i>BLACK BEAN COFFEE CONTAIN.LID RYLO ASSY.</i>
	20		12001431	SCREW TCB TORX 10 3X12 PLAST.SS <i>SCREW TCB TORX 10 3X12 PLAST.SS</i>
	21		17001255	ЗАТИЧКА 1 ШТ <i>BLACK PLUG FOR WATER CONTAIN.HANDLE RYL</i>
	22		17001987	STEEL CONTAINERS LID LOCK BRACKET RYLO <i>STEEL CONTAINERS LID LOCK BRACKET RYLO</i>
	23		11025829	CRC CONTAINERS LID RYLO TO ASSY. <i>CRC CONTAINERS LID RYLO TO ASSY.</i>
	23		421941301061	TXO/BLK CONTAINERS LID RYLO TO ASSY. <i>TXO/BLK CONTAINERS LID RYLO TO ASSY.</i>
	24		17000982	BLACK DRIP TRAY COVER RYL <i>BLACK DRIP TRAY COVER RYL</i>

Model Machine

MACSAE218

OCS SAE AULIKA TOP HSC SIL 230/50 SCH (10004886)

MACSAE218.T.0006



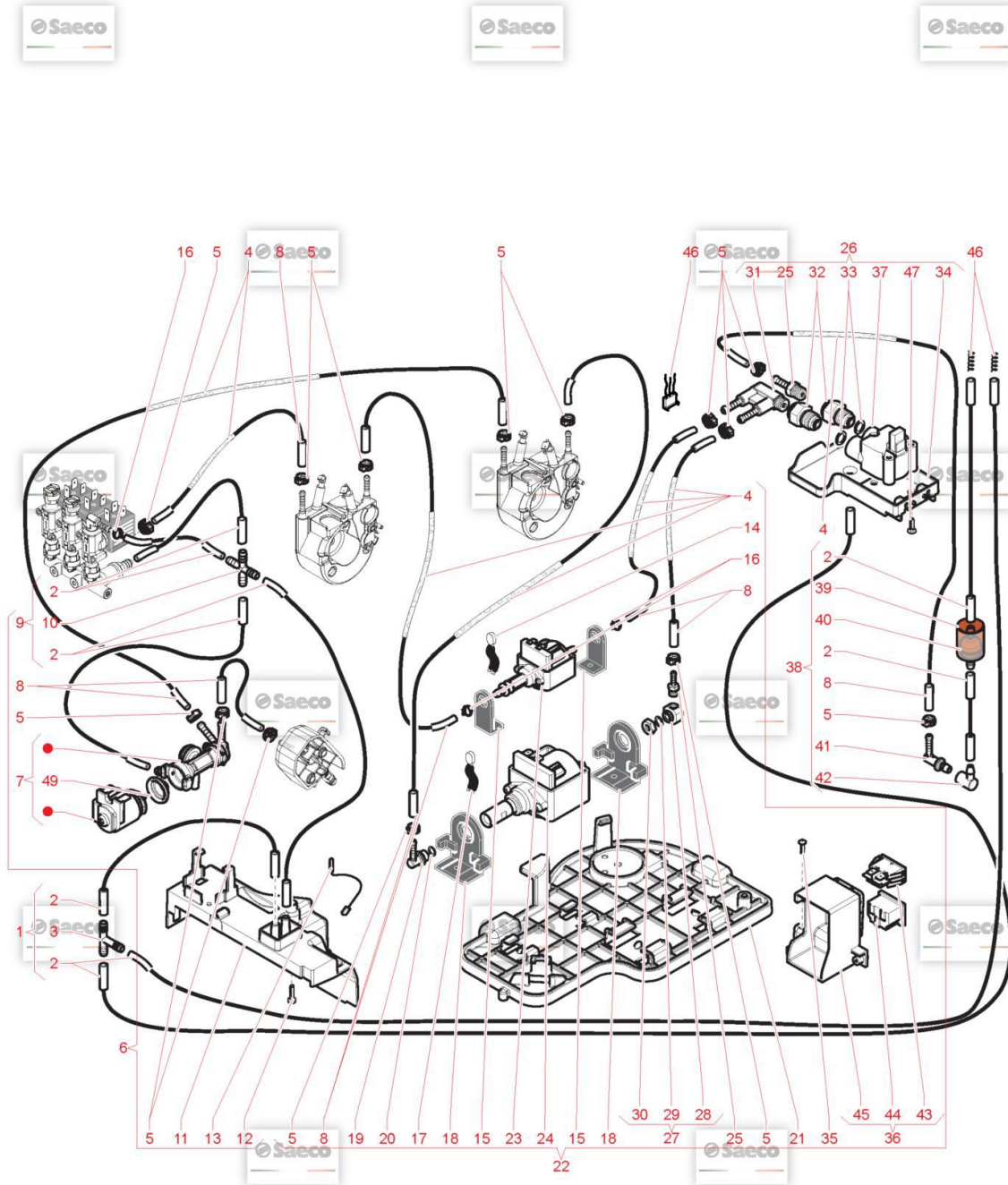























TAVOLA NR. 6 - ARTICOLO OCS SAE AULIKA TOP HSC SIL 230/50 SCH (10004886)



Model Machine

MACSAE218













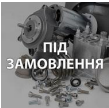













OCS SAE AULIKA TOP HSC SIL 230/50 SCH (10004886)

Web	Pos.	Foto	Item - Replace by	Description
				<i>Press - CTRL + CLICK go to item in a new window Натисніть - Ctrl + права кнопка миші щоб відкрити запчастину в новому вікні</i>
	1		129913902	SCREW TCB TORX 10 3X12 PLAST.ZN-B SCREW TCB TORX 10 3X12 PLAST.ZN-B
	2		9161.048	STEEL GROUND COF.DOSER SCRAPERROD ASTA RASATORE
	3		9161.076.150	GREY GROUND COF.DOSER DOOR PIN PERNO SPORTELLO DOSATORE GRIGIO
	4		9161.074.150	GREY GROUND COFFE DOSER DOOR SPORTELLO DOSATORE GRIGIO
	5		126764818	ПРУЖИНА ЕЛЕКТРОМАГНІТНОГО ДОЗАТОРА ЗЕРНА MAGIC SAECO 916... SPRING ELECTROM.BEAN DOSER MAGIC
	6		U701.003	SNAP RING 7 UNI 7434 ANELLO ELASTICO 7 UNI 7434
	7		9161.041	STEEL GROUND COF.DOSER ELECTROMAGN.CORE NUCLEO ELETTRROMAGNETE DOSATORE
	8	 ПІД ЗАМОВЛЕННЯ	421946000541	4P.CONN.COIL+DOSER MICRO V2 RYL UL ASSY. 4P.CONN.COIL+DOSER MICRO V2 RYL UL ASSY.
	9		11025734	DOSER COIL FOR SUPERAUTOM.24VDC ASSY. DOSER COIL FOR SUPERAUTOM.24V DC ASSY.
	10		NE05.017	MICROSWITCH MICROSWITCH NE05.017
	11		9161.072.150	GREY MICRO SUPP.CURSOR GROUNDCOF.DOSER MICRO SUPPORT CURSOR GREY
	12		9161.073.150	GREY GROUND COF.DOSE CONTROL COMPENSATOR DOSE CONTROL COMPENSATOR GREY
	13		17000176	BLACK HOPPER FOR POWDER COFFEERYL BLACK HOPPER FOR POWDER COFFEE RYL

Model Machine

MACSAE218























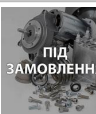

OCS SAE AULIKA TOP HSC SIL 230/50 SCH (10004886)

	14		9161.082	RUBBER COUPLER <i>AGGANCIO IN GOMMA</i>
	15		0333.009	BLK GRINDING ADJUST.LEVER HANDGRIP ROYAL <i>BLK GRINDING ADJUST.LEVER HANDGRIP ROYAL</i>
	16		9141.080	ТРИМАЧ ДВИГУНА КАВОМОЛКИ ДЛЯ КАВОВАРКИ SAECO 9141.080 <i>SUPPORTO MOTORE</i>
	17		140360200	FELT RING 40X34X5 <i>ANELLO IN FELTRO DE=40 DI=34</i>
	18		126770117	NEW SPRING SPHERE D=3,2 MOTORMAGIG <i>MOLLA NEW X SFERA D=3,2 MOTORE MAGIC</i>
	19		421946000531	2P.CONN.GRINDER MOTOR V2 RYL UL ASSY. <i>2P.CONN.GRINDER MOTOR V2 RYL UL ASSY.</i>
	20		1505.014	COFFEEGRINDER SEAL <i>GUARNIZIONE DOSATORE</i>
	21		144320200	SELF LOCK STRIP W=2.6 L=200 <i>SELF LOCK STRIP W=2.6 L=200</i>
	22		9140.036.00A	КАВОМОЛКА В ЗБОРИ 230V PHILIPS SAECO 996530065687 <i>COFFEE GRINDER STD 230V ASSY.</i>
	22		9140.036.00F	ASS.MOTOR STD 120V <i>ASS.MOTOR STD 120V</i>
	23		0301.R10.00A	SPARE MOTOR UNIT MC 230V <i>GRUPPO RICAMBIO MOTORE MC 230 V</i>
	23		0301.R10.00F	SPARE MOTOR UNIT MC 120V <i>SPARE MOTOR UNIT MC 120V</i>
	24		U043.004	ZN-B TCB TORX 20 M4X16 ZN-B <i>VITE TCBC M4,0X16 UNI 7687 ZNP</i>
	25		9991.005	RUBBER FOR COFFEE GRINDER <i>GOMMINO X MACINA CAFFE</i>

Model Machine

MACSAE218











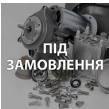





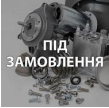



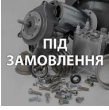

OCS SAE AULIKA TOP HSC SIL 230/50 SCH (10004886)

	26		9141.003	SPACER FOR RUBBER SPACER FOR RUBBER
	27		U324.006	ШАЙБА М4 NUT M4 FLANGED INDENTED BASE
	28		12001605	МІКРИК MICROSWITCH
	29		9161.365.150	GREY PLATE COFFEEGRINDER MAGIC/ROYAL PIASTRA X MACINACAFFE' GRIGIO/7016
	30		128610521	STAIL.STEEL AISI 304 SPHERE D=5,5MM SFERA D=5,5MM ACCIAIO INOX A
	31		126765517	STEEL SPRING SPHERE D=5,5 MOTOR MAGIC MOLLA ACC.X SFERA D=5,5 MOTO
	32	 ПІД ЗАМОВЛЕННЯ	9161.097.150	GREY GROUND COF.DOSER LEVER FIXING PLATE LEVER FIXING PLATE GREY
	33		0313.003.150	7016/GREY GROUND COF.DOSER ADJUSTM.LEVER LEVA DI REGOLAZIONE GRIGIO R
	34		0333.008	STEEL GRINDING ADJUSTMENT LEVER STEEL GRINDING ADJUSTMENT LEVER
	35		17000238	COFFEE GRINDER SOUNDPROOFING COVER RYL COFFEE GRINDER SOUNDPROOFING COVER RYL
	36		9991.103	АМОРТИЗАТОР ДЛЯ КОФЕМОЛКИ КОФЕМАШИН PHILIPS SAECO 996530... AMMORTIZZATORE PER MACINACAFE
	37		140230400	SHOCK ABS .CONICAL GRINDER SUPP.MAGIC AMMORTIZ.X SUPPOR.MACIN.CONI
	38		U201.001	PLAIN WASHER 3,2X9 DIN 7349 GALV. PLAIN WASHER 3,2X9 DIN 7349 GALV.

Model Machine

MACSAE218

OCS SAE AULIKA TOP HSC SIL 230/50 SCH (10004886)

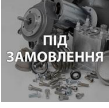
	39		17000832	GRY COFF.GRINDING/DOSE ADJUST.SCALE RYLO GRY COFF.GRINDING/DOSE ADJUST.SCALE RYLO
	40		149186150	BLACK UPPER GRINDER SUPPORT MAGIC SUPPORT.NER.X MACINA SUPERIO
	42		142844550	UPPER GRINDER COVER COFFEE GRIND. MAGIC UPPER GRINDER COVER COFFEE GRIND. MAGIC
	43		129931002	TORX SCREW T10 TCB 3,5X40 SX ZNG TORX SCREW T10 TCB 3,5X40 SX ZNG
	44		147470763	BLK INCREASE SCREW PIN COF.GRINDER MAGIC PERNO INCREM.A VITE X MACINA
	45		U201.002	PLAIN WASHER 10X16X0,2DIN 988GAL ROSETTA PIANA 10X16X0,2DIN
	46		226477700	KIT ITAL MILL GRINDERS COPPIA DI MACINE SAECO CONICHE
	47		149188750	CONICAL GRIND. SUPP. + RING MAGIC CONICAL GRIND. SUPP. + RING MAGIC
	48		146570950	RING NUT FOR GRINDING ADJUSTMENT MAGIC GHIERA NERA REGOLAZ.MACINATU
	49		128610421	STAIL.STELL AISI 304 SPHERE D=3,2MM SFERA D=3,2MM ACCIAIO INOX A
	50		12000450	SCREW TCBR TORX 10 3,5X12 PLAST.ZN-N SCREW TCBR TORX 10 3,5X12 PLAST.ZN-N
	51		17001155	GREY COVER FOR DOSER HOLE RYL GREY COVER FOR DOSER HOLE RYL

Model Machine

MACSAE218

OCS SAE AULIKA TOP HSC SIL 230/50 SCH (10004886)

MACSAE218.T.0007



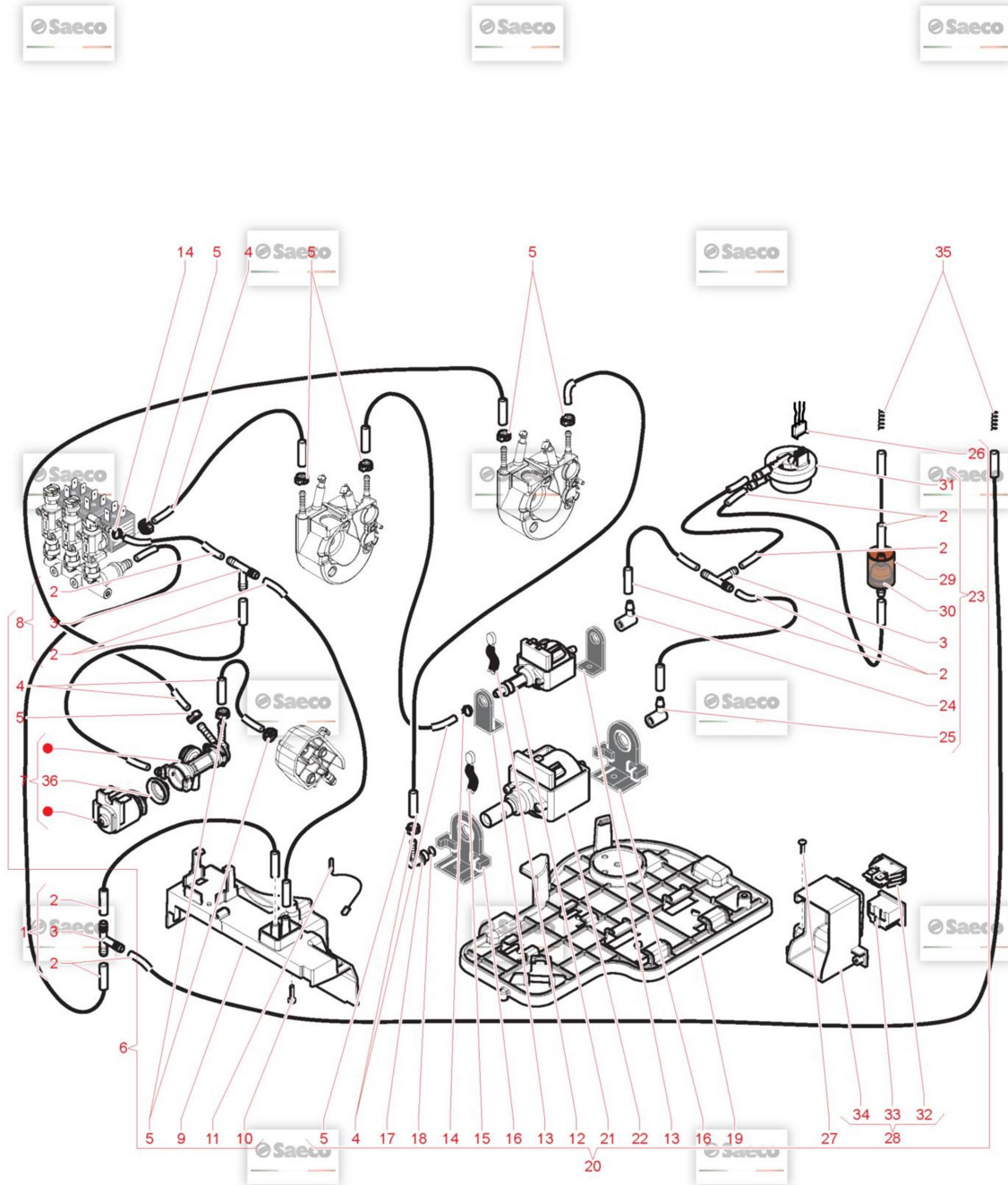









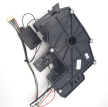



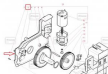









TAVOLA NR. 7 - ARTICOLO OCS SAE AULIKA TOP HSC SIL 230/50 SCH (10004886)



Model Machine

MACSAE218

OCS SAE AULIKA TOP HSC SIL 230/50 SCH (10004886)

Web	Pos.	Foto	Item - Replace by	Description
				<i>Press - CTRL + CLICK go to item in a new window Натисніть - Ctrl + права кнопка миші щоб відкрити запчастину в новому вікні</i>
	1		11025736	РЕДУКТОР ВЗБОРИ PHILIPS SAECO 996530068554 RATIOMOTOR RYL ASSY.
	2		129670202	TCB PANELVIT SCREW 3,5X16 TESTA D=8 ZNP TCB PANELVIT SCREW 3,5X16 TESTA D=8 ZNP
	3		17000719	GREY RATIOMOTOR LID RYL GREY RATIOMOTOR LID RYL
	4		11007137	BLACK GEAR Z=77 V2 FOR RATIOMOTOR P124 BLACK GEAR Z=77 V2 FOR RATIOMOTOR P124
	5		9161.368	MYLAR WASHER FOR RATIOMOTOR RONDELLA MYLAR X MOTORIDUTTORE
	6		NE05.038	MICROSWITCH 30V 0.3A MICROINTERRUTTORE
	7		146002800	GREY GEAR Z=13/90 FOR RATIOMOTOR P124 GREY GEAR Z=13/90 FOR RATIOMOTOR P124
	8		11026258	GREY RATIOMOTOR CASING WITH TUBE ASSY. GREY RATIOMOTOR CASING WITH TUBE ASSY.
	9		148380200	BAKELIZZATE WASHER D=5,5 BAKELIZZATE WASHER D=5,5
	10		9121.046	BRONZE SINTERED BUSH FOR MOTORRATIOMOT. BRONZE SINTERED BUSH FOR MOTOR RATIOMOT.
	11		11005214	MOTOR FOR RATIOMOTOR ASSY. MOTOR FOR RATIOMOTOR P124 ASSY
	12		9121.044	ANTIVIBRATION FOR MOTOR ANTIVIBRANTE X MOTORE
	13		11003800	BLACK BREW UNIT BLACK BREW UNIT MAGIC/ROYAL

Model Machine

MACSAE218

OCS SAE AULIKA TOP HSC SIL 230/50 SCH (10004886)

MACSAE218.T.0008



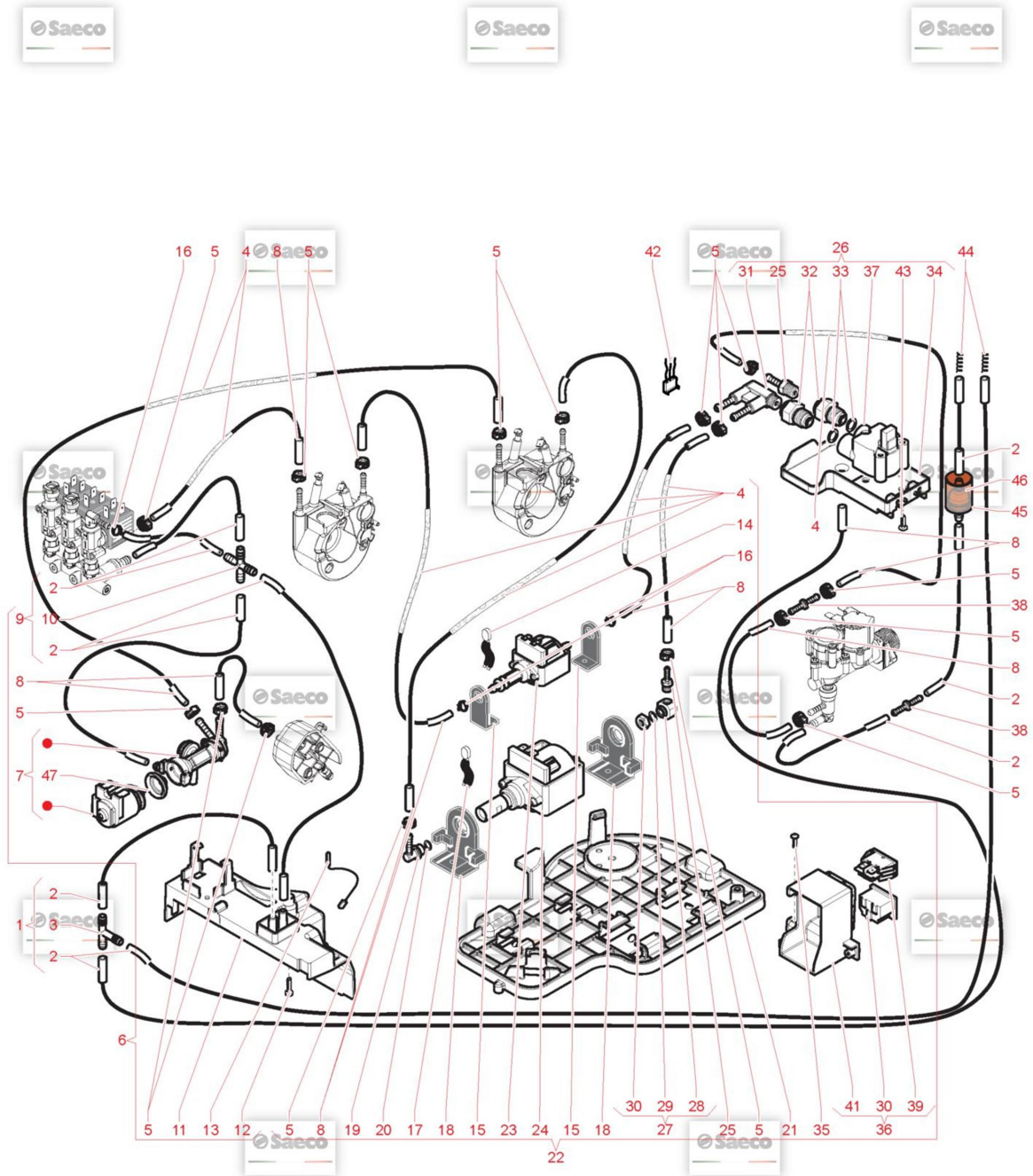











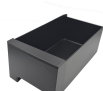











TAVOLA NR. 8 - ARTICOLO OCS SAE AULIKA TOP HSC SIL 230/50 SCH (10004886)



Model Machine

MACSAE218













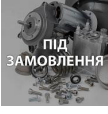

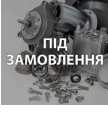

OCS SAE AULIKA TOP HSC SIL 230/50 SCH (10004886)

Web	Pos.	Foto	Item - Replace by	Description
				<i>Press - CTRL + CLICK go to item in a new window Натисніть - Ctrl + права кнопка миші щоб відкрити запчастину в новому вікні</i>
	1		11029731	CRC BASE REPOSITORY DRAWER RYLO CRC BASE REPOSITORY DRAWER RYLO
	1		421941302441	ШУХЛЯДА ЛІВА, ЧОРНА ДЛЯ БАЗОВОЇ ПІДСТАВКИ TXO/BLK BASE REPOSITORY DRAWER RYLO
	2		11029719	CRC BASE DUMP BOX RYLO ASSY. CRC BASE DUMP BOX RYLO ASSY.
	2		421941302531	TXO/BLK BASE DUMP BOX RYLO ASSY. TXO/BLK BASE DUMP BOX RYLO ASSY.
	3		11021829	ФІКСУЮЧИЙ НІС НИЖНІЙ ЧАСТИНИ КОРПУСУ (НІЖКИ) PHILIPS SAECO 9... BLACK/TRANSP.RIGID FOOT MYB9
	4		11021769	BLACK RIGID FOOT FIXING PIN MYB9 BLACK RIGID FOOT FIXING PIN MYB9
	5		421946005111	BLK STEEL BASE CASING V2 RYLO ASSY. BLK STEEL BASE CASING V2 RYLO ASSY.
	6		12001622	SCREW TCB TORX B 3,5X9,5 SCHEET NIK SCREW TCB TORX B 3,5X9,5 SCHEET NIK
	7		13001519	PS-E INSERT FOR BOX BASE RYLO PS-E INSERT FOR BOX BASE RYLO
	8		13001676	HAVANA BOX V2 BASE RYLO HAVANA BOX V2 BASE RYLO
	9		11029700	BLACK BASE REAR PANEL RYLO BLACK BASE REAR PANEL RYLO
	10		129914302	SCREW TORX M4X10 TESTA D=8X1,5 GALV SCREW TORX M4X10 TESTA D=8X1,5 GALV
	11		17001582	НАДЛИШКОВИЙ КЛАПАН ВИСОКОГО ТИСКУ SAECO SS-7117001582 CONNECT.WATER SUPPLY RYLO RI ASSY.

Model Machine

MACSAE218

OCS SAE AULIKA TOP HSC SIL 230/50 SCH (10004886)

	12		11029701	BLACK BASE REAR PANEL RYLO RI <i>BLACK BASE REAR PANEL RYLO RI</i>
	13		129912104	SCREW TCBR TORX 20 4X10 PLAST.ZN-N <i>SCREW TCBR TORX 20 4X10 PLAST.ZN-N</i>
	14		NV99.075	GHIERA IN NYLON G3/4" 6 MM. <i>"GHIERA IN NYLON G3/4" 6 MM.</i>
	15		NV03.002	CAP 3/4 "KAPSTO 800R 3/4" <i>"CAP 3/4 "KAPSTO 800R 3/4""</i>
	16		JS01.022	SILICONE TUBE 5X10 60SH IN ROLL <i>SILICONE TUBE 5X10 60SH IN ROLL</i>
	17		16000380	5X8,9 SILICONE TUBE IN ROLL <i>5X8,9 SILICONE TUBE IN ROLL</i>
	18		12000892	ЗАЖИМ D.9,5 16700004 <i>OETIKER CLAMP D=9,5 16700004 (L250)</i>
	19		17001018	BLACK WATER SUPPLY CONNECTOR RYLO RI <i>BLACK WATER SUPPLY CONNECTOR RYLO RI</i>
	20		421946001221	3P.CONN.SUPPLY COIL V2 RYLO RIUL ASSY. <i>3P.CONN.SUPPLY COIL V2 RYLO RI UL ASSY.</i>

Model Machine

MACSAE218

OCS SAE AULIKA TOP HSC SIL 230/50 SCH (10004886)

MACSAE218.T.0009



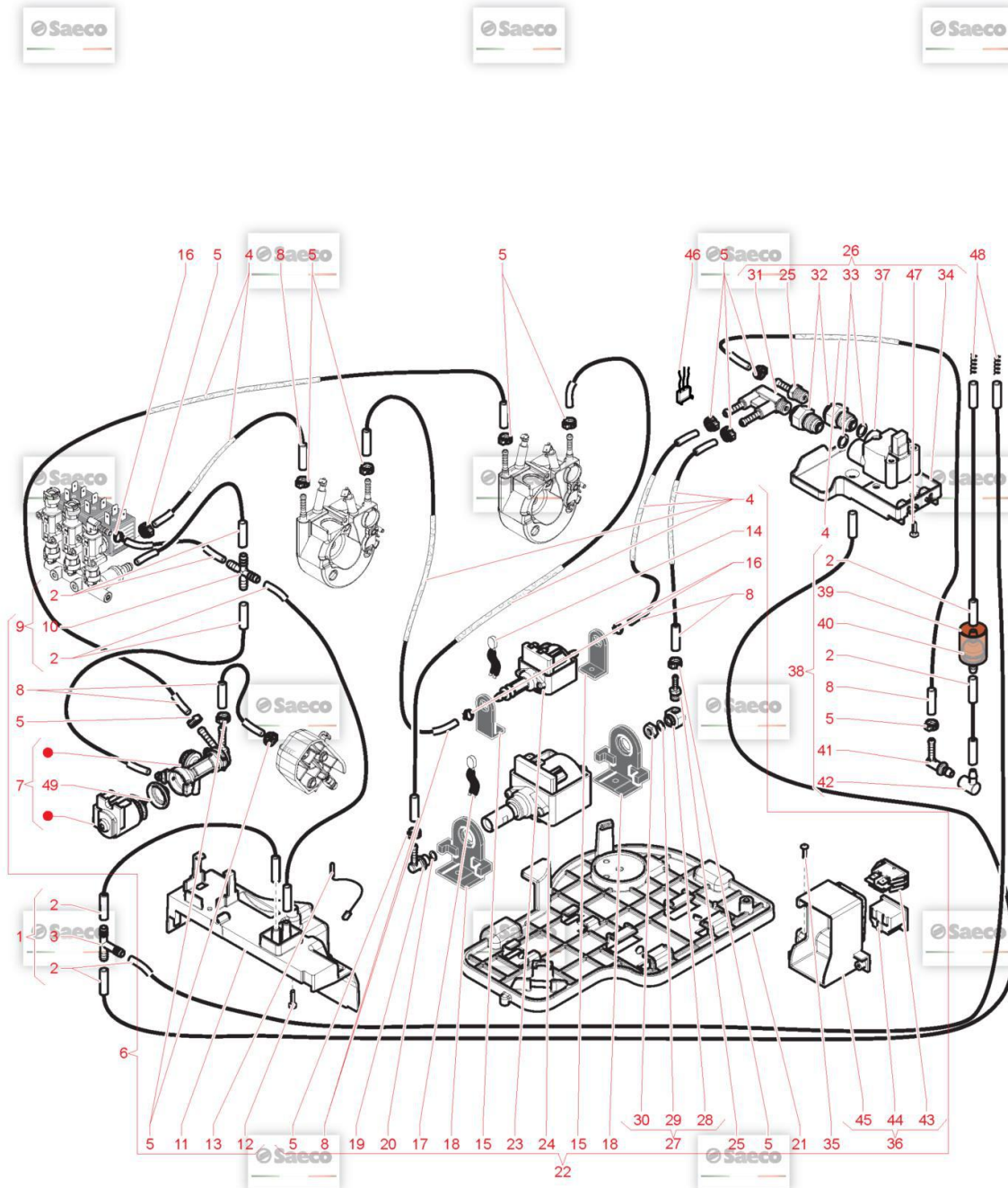























TAVOLA NR. 9 - ARTICOLO OCS SAE AULIKA TOP HSC SIL 230/50 SCH (10004886)



Model Machine

MACSAE218





























OCS SAE AULIKA TOP HSC SIL 230/50 SCH (10004886)

Web	Pos.	Foto	Item - Replace by	Description
				<i>Press - CTRL + CLICK go to item in a new window Натисніть - Ctrl + права кнопка миші щоб відкрити запчастину в новому вікні</i>
	1		11003789	BLACK COFF.OUTLET SLEEVE BREWUNIT ROYAL <i>BLACK COFF.OUTLET SLEEVE BREW UNIT ROYAL,AULIKA MAGIC SAECO</i>
	2		9161.222	SS.CONICAL SPRING <i>MOLLA CONICA</i>
	3	 ПІД ЗАМОВЛЕННЯ	9991.168	GLASS SPHERE D.5 MM <i>SFERA IN VETRO D.5 MM</i>
	4		11021334	BLK COUNTERPISTON SEAL DE=11 DI=8 SP=1,4 <i>BLK COUNTERPISTON SEAL DE=11 DI=8 SP=1,4</i>
	5		11003796	BLACK BREW UNIT COUNTERPISTONM5000 <i>BLACK BREW UNIT COUNTERPISTON M5000</i>
	6		NM01.044	OR ORM 0320-40 SILICONE PTFE/FDA <i>OR ORM 0320-40 SILICONE PTFE</i>
	7	 ПІД ЗАМОВЛЕННЯ	11004114	BLACK BREW UNIT COUPLING PLATE <i>BLACK BREW UNIT COUPLING PLATE</i>
	8	 ПІД ЗАМОВЛЕННЯ	421941158532	BLACK BREW UNIT REAR PLATE V2M5000 <i>BLACK BREW UNIT REAR PLATE V2 M5000</i>
	9		U140.019	SCREW TCB TORX 10 3X16 PLAST SS <i>PANELVIT TCB 3,0X16 DIN 7505</i>
	10		227470150	PIN BLACK ASS.FOR PERCOLATOR <i>PIN BLACK ASS.FOR PERCOLATOR</i>
	11		NM02.006	OR R5 TERMOIL <i>OR R5 EPDM</i>
	12		9161.064.050	BLACK WATER INLET SLEEVE BREWUNIT ROYAL <i>BLACK WATER INLET SLEEVE BREW UNIT ROYAL</i>
	13		NM02.007	OR 2025 IN TERMOIL <i>OR 2025 TERMOIL</i>

Model Machine

MACSAE218











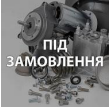

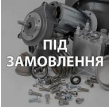

OCS SAE AULIKA TOP HSC SIL 230/50 SCH (10004886)

	14		20000440	BLACK WATER INLET SLEEVE BREWUNIT ASSY. <i>BLACK WATER INLET SLEEVE BREW UNIT ASSY.</i>
	15		9160.075	PERCOLATOR DE=35,8 ELFO ASSY. <i>PERCOLATOR DE=35,8 ELFO ASSY.</i>
	16		11001556	SS BREW UNIT SPRING H=49 SMART <i>SS BREW UNIT SPRING H=49 SMART</i>
	17		9161.094.050	BLACK BREW UNIT DRILLED BLOCK <i>BLACK BREW UNIT DRILLED BLOCK</i>
	18		11004161	BLACK SCRAPER FOR BREW UNIT M5000 <i>BLACK SCRAPER FOR BREW UNIT M5000</i>
	19		9161.066.050	BLACK BREW UNIT ELBOW SHAFT M5000 <i>BLACK BREW UNIT ELBOW SHAFT M5000</i>
	20	 ПІД ЗАМОВЛЕННЯ	11003793	BLACK BREW UNIT FRONT PLATE M5000 <i>BLACK BREW UNIT FRONT PLATE M5000</i>
	21		12000550	CAMOPI3 TCB TORX 10 3X25 PLAST.SS <i>SCREW TCB TORX 10 3X25 PLAST.SS</i>
	22	 ПІД ЗАМОВЛЕННЯ	11003077	BLK BREW UNIT INTEGRAL PISTON8GR.ASSY. <i>BLK BREW UNIT INTEGRAL PISTON 8GR.ASSY.</i>
	23		9161.198	SS.8GR.BREW UNIT PISTON SPRING <i>SS.8GR.BREW UNIT PISTON SPRING</i>
	24		9161.191	WHITE 8GR.-12GR.BREW UNIT PISTON BUSH <i>BOCCOLA X PISTONE NEUTRO</i>
	25		NM02.018	OR ORM 0090-25 TERMOIL <i>OR ORM 0090-25 TERMOIL</i>
	26		421944014611	BLK COF.CONTAIN.BREW UNIT V2 M5000 ASSY. <i>BLK COF.CONTAIN.BREW UNIT V2 M5000 ASSY.</i>
	27		11003078	BLACK CONNECTING ROD BREW UNIT 8GR. <i>BLACK CONNECTING ROD BREW UNIT 8GR.</i>

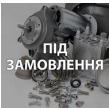
Model Machine

MACSAE218

OCS SAE AULIKA TOP HSC SIL 230/50 SCH (10004886)

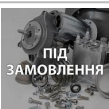
	28		11003795	BLACK HOPPER COFF.BREW UNIT S/SCR.M5000 <i>BLACK HOPPER COFF.BREW UNIT S/SCR.M5000</i>
	29		9161.046	ПРУЖИНА ВОРОНКИ ЗАВАРОЧНОГО БЛОКА ДЛЯ КОФЕМАШИН PHILIPS ... <i>MOLLA X RASATORE GRUPPO</i>
	30		12000897	SCREW TCB TORX 10 3,5X20 PLAST.SS <i>SCREW TCB TORX 10 3,5X20 PLAST.SS</i>
	31		9161.045	SS BREW UNIT HANDGRIP SPRING M5000 <i>MOLLA X IMPUGNATURA GRUPPO</i>
	32		11003791	BLACK BREW UNIT HANDGRIP M5000 <i>BLACK BREW UNIT HANDGRIP M5000</i>
	33		129912521	SCREW TCBR TORX 10 3,5X14 PLAST.SS <i>SCREW TCBR TORX 10 3,5X14 PLAST.SS</i>
	34		11023086	BLK 8GR.BREW UNIT NTEGR.PISTONGEN.ASSY. <i>BLK 8GR.BREW UNIT NTEGR.PISTON GEN.ASSY.</i>
	35		11003800	BLACK BREW UNIT <i>BLACK BREW UNIT MAGIC/ROYAL</i>

Model Machine

MACSAE218

OCS SAE AULIKA TOP HSC SIL 230/50 SCH (10004886)

MACSAE218.T.0010

TAVOLA NR. 10 - ARTICOLO OCS SAE AULIKA TOP HSC SIL 230/50 SCH (10004886)

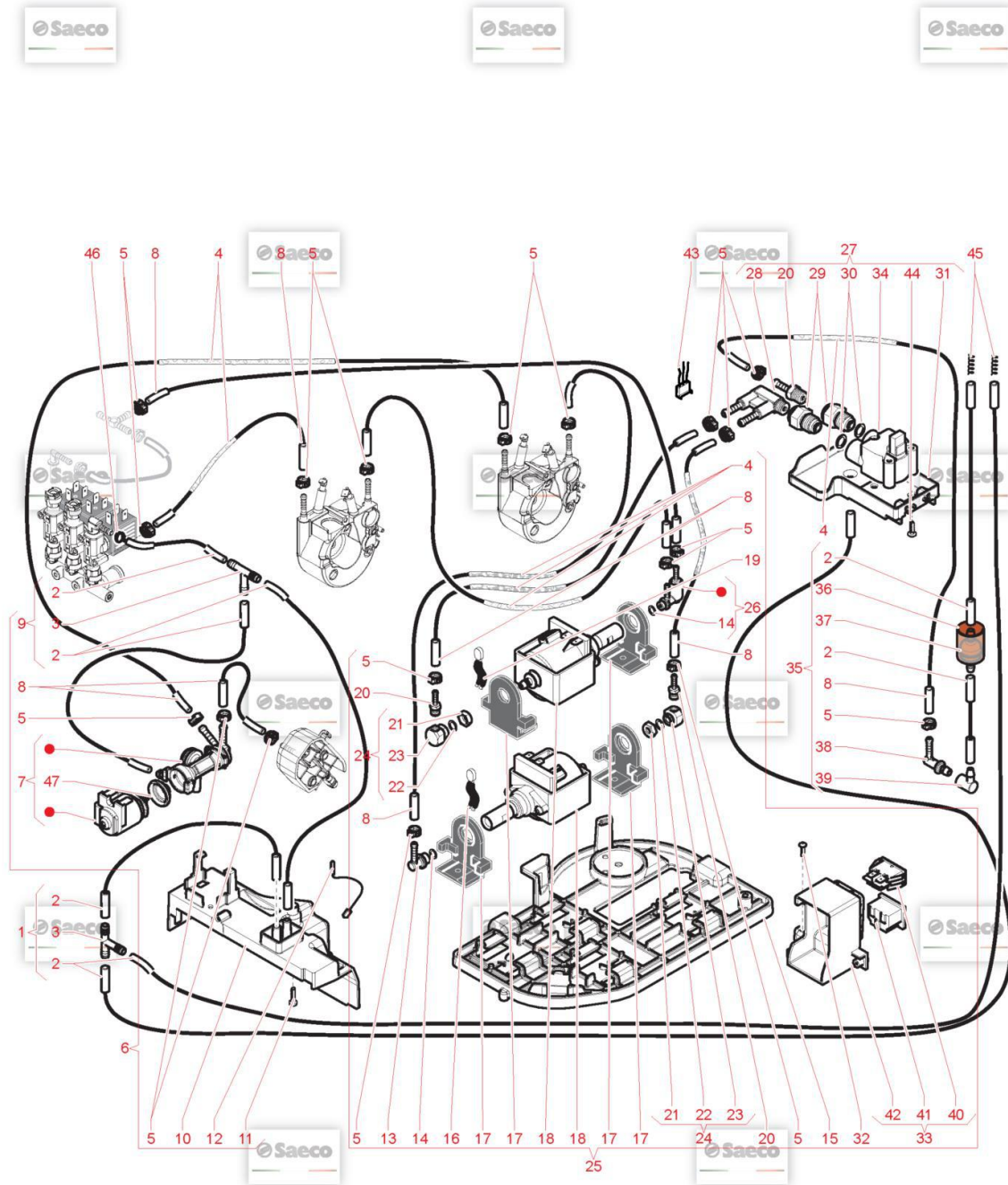

Model Machine

MACSAE218

OCS SAE AULIKA TOP HSC SIL 230/50 SCH (10004886)

Web Pos. Foto Item - Replace by Description



Press - CTRL + CLICK go to item in a new window













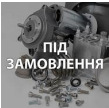













Натисніть - Ctrl + права кнопка миші щоб відкрити запчастину в новому вікні

Web	Pos.	Foto	Item - Replace by	Description
	1		11029674	WATER CONT/TURBINE DRAIN TUBESRYLO ASSY WATER CONT/TURBINE DRAIN TUBESRYLO ASSY
	2		11035450	SILICONE TUBE 5X10 L.2000MM TUBO SILICONE 5X10 TRASP. L.2000MM
	3		147920300	TRANS.CONNECTOR D=8 ART.80.26.047 KA.461 RACCORDO T D=8 ART.80.26.047 KA.461
	4		11032467	SILICONE TUBE 11X12,8 L.2000 MM TUBO SILICONE 11X12.8 L=2000 MM
	5		12000892	ЗАЖИМ D.9,5 16700004 OETIKER CLAMP D=9,5 16700004 (L250)
	6		17004117	220V/BLK PROT+BLOWDOWN VALVE RYLO K AS. 220V/BLK PROT+BLOWDOWN VALVE RYLO K AS.
	7		11028161	BLOWDOWN VALVE V3 RYL 220V-60HZ ASSY. BLOWDOWN VALVE V3 RYL 220V-60HZ ASSY.
	8		11027788	PINK 5X8,9 SILICONE TUBE L=2000MM TUBO SIL.RETIN.5X8.9 L=2000MM ROSA
	9		17004116	SAFETY VALVE/EV DRAIN TUBES RYLO K ASSY. SAFETY VALVE/EV DRAIN TUBES RYLO K ASSY.
	10		17000165	BLACK DRIP TRAY PROTECTION RYL BLACK DRIP TRAY PROTECTION RYL
	11		129913902	SCREW TCB TORX 10 3X12 PLAST.ZN-B SCREW TCB TORX 10 3X12 PLAST.ZN-B
	12		17800442	2POLES CONNECT.SENSOR REED DUMP BOX CST 2POLES CONNECT.SENSOR REED DUMP BOX CST
	13		11001054	СОЕДИНИТЕЛЬНЫЙ УГОЛОК 90° К НАСОСУ P0049/B PHILIPS SAECO 996... BLK PUMP OUTLET 90° CONNECTOR P0049/B

Model Machine

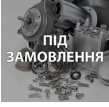
MACSAE218













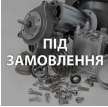



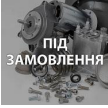



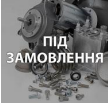



OCS SAE AULIKA TOP HSC SIL 230/50 SCH (10004886)

	14		140321961	ПРОКЛАДКА O-RING ДЛЯ КАВОМАШИНИ SAECO 2031 TERMOIL OR 2031 IN TERMOIL
	15	 ПІД ЗАМОВЛЕННЯ	17004032	BLK COMPONENTS SUPPORT RYLO V2KR BLK COMPONENTS SUPPORT RYLO V2KR
	16	 ПІД ЗАМОВЛЕННЯ	17800202	2POLES CONNECTOR COFFEE PUMP RYL UL 2POLES CONNECTOR COFFEE PUMP RYL UL
	17		11022857	BLACK PUMP SUPPORT GMYB BLACK PUMP SUPPORT GMYB
	18	 ПІД ЗАМОВЛЕННЯ	12000182	ULKA PUMP EP5/S GW 220V-60HZ ULKA PUMP EP5/S GW 220V-60HZ
	19	 ПІД ЗАМОВЛЕННЯ	17004120	2P.CONN.STEAM PUMP V2 RYL UL ASSY. 2P.CONN.STEAM PUMP V2 RYL UL ASSY.
	20		11006304	TEA/BRASS CONNECTOR FOR ALUM.BOILER TEA/BRASS CONNECTOR FOR ALUM.BOILER
	21		9181.350	TEA/BRASS REAR CONNECTOR 1/8"ULKA PUMP TEA/BRASS REAR CONNECTOR 1/8 ULKA PUMP
	22	 ПІД ЗАМОВЛЕННЯ	NM03.017	O-RING R6 NBR OR R6 NBR
	23	 ПІД ЗАМОВЛЕННЯ	9071.054	BRASS NUT FOR ULKA PUMP REAR CONNECTOR BRASS NUT FOR ULKA PUMP REAR CONNECTOR
	24	 ПІД ЗАМОВЛЕННЯ	9079.A37	REAR CONN. ASS. M5 FOR ULKA PUMP REAR CONN. ASS. M5 FOR ULKA PUMP
	25	 ПІД ЗАМОВЛЕННЯ	17004040	COMPONENTS SUPP.ASSY. RYLO V2KR COMPONENTS SUPP.ASSY. RYLO V2KR
	26	 ПІД ЗАМОВЛЕННЯ	17004041	SAFETY VALVE 5 BAR ASSY. SAFETY VALVE 5 BAR ASSY.
	27	 ПІД ЗАМОВЛЕННЯ	11025871	GEN.TURBINE RYLO ASSY. GEN.TURBINE RYLO ASSY.

Model Machine

MACSAE218

OCS SAE AULIKA TOP HSC SIL 230/50 SCH (10004886)

	28		11010243	TEA/BRASS 90° DOUBLE CONNECTOR <i>TEA/BRASS 90° DOUBLE CONNECTOR</i>
	29	 ПІД ЗАМОВЛЕННЯ	9181.406	TEA/BRASS CONNECTOR TURBINE MF1/4 1/8 <i>TEA/BRASS CONNECTOR TURBINE MF 1/4 1/8</i>
	30		NM01.049	OR ORM 0070-20 SILICONE <i>OR ORM 0070-20 SILICONE</i>
	31	 ПІД ЗАМОВЛЕННЯ	17000821	BLACK TURBINE SUPPORT RYLO <i>BLACK TURBINE SUPPORT RYLO</i>
	32		12000450	SCREW TCBR TORX 10 3,5X12 PLAST.ZN-N <i>SCREW TCBR TORX 10 3,5X12 PLAST.ZN-N</i>
	33	 ПІД ЗАМОВЛЕННЯ	421941294291	IEC CONNECTOR V2 RYL ASSY. <i>IEC CONNECTOR V2 RYL ASSY.</i>
	34		NV99.033	ПЛАСТИКОВА ТУРБИНА ВИСОКОГО ТИСКУ <i>TURBINA DIGMESA IN PLASTICA</i>
	35	 ПІД ЗАМОВЛЕННЯ	11029900	ASPIRATION TUBES RYLO ASSY. <i>ASPIRATION TUBES RYLO ASSY.</i>
	36		147756562	BLK PROTECTION FOR FOLK SPRING TUBE D=4 <i>BLK PROTECTION FOR FOLK SPRING TUBE D=4</i>
	37		12001595	TRANSP/WHITE ASPIRATION FILTER MDS <i>TRANSP/WHITE ASPIRATION FILTER MDS</i>
	38		17001358	BLK WATER CONT/FLOWMETER 90°CONNECT.RYLO <i>BLK WATER CONT/FLOWMETER 90°CONNECT.RYLO</i>
	39		147920150	90° INLET PUMP CONNECTOR <i>RACCORDO A 90° IN SANTOPRENE</i>
	40	 ПІД ЗАМОВЛЕННЯ	NE03.038	BIPOLAR SWITCH FUSIT C1250AR <i>BIPOLAR SWITCH FUSIT C1250AR</i>

Model Machine

MACSAE218

OCS SAE AULIKA TOP HSC SIL 230/50 SCH (10004886)

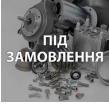
	41		12001883	CUP SOCKET V3 EN 60320 C 13 <i>CUP SOCKET V3 EN 60320 C 13</i>
	42	 ПІД ЗАМОВЛЕННЯ	17000162	BLACK SOCKET-SWITCH SUPPORT RYL <i>BLACK SOCKET-SWITCH SUPPORT RYL</i>
	43	 ПІД ЗАМОВЛЕННЯ	421946001561	6P.CONN.FLOWMETER V2 RYLO UL ASSY. <i>6P.CONN.FLOWMETER V2 RYLO UL ASSY.</i>
	44	 ПІД ЗАМОВЛЕННЯ	129912104	SCREW TCBR TORX 20 4X10 PLAST.ZN-N <i>SCREW TCBR TORX 20 4X10 PLAST.ZN-N</i>
	45	 ПІД ЗАМОВЛЕННЯ	0701.081	SPRING FOR TUBE PRODUCT 1 <i>SPRING FOR TUBE PRODUCT 1</i>
	46		184320200	SPRING HOSE CLAMP D=9,5MM <i>MOLLA STRINGITUBO D=9,5MM</i>
	47		11001513	MEMBRANA KŁAPANA AULIKA, ODEA SAECO <i>GUARNIZ. A MEMBRANA VALV. SCARICO</i>

Model Machine

MACSAE218

OCS SAE AULIKA TOP HSC SIL 230/50 SCH (10004886)

MACSAE218.T.0011



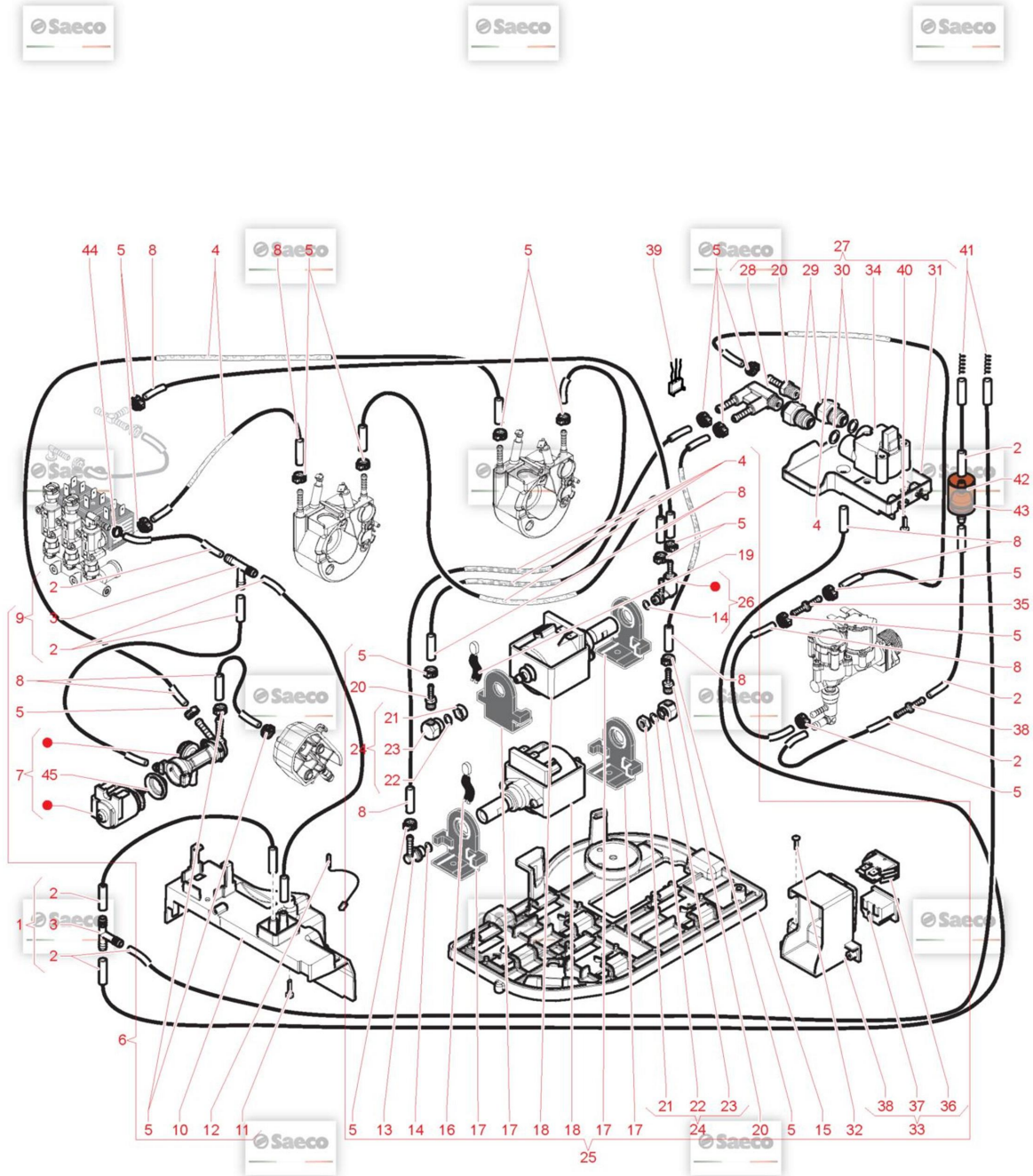









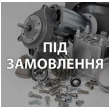

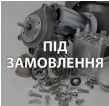











TAVOLA NR. 11 - ARTICOLO OCS SAE AULIKA TOP HSC SIL 230/50 SCH (10004886)



Model Machine

MACSAE218













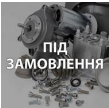













OCS SAE AULIKA TOP HSC SIL 230/50 SCH (10004886)

Web	Pos.	Foto	Item - Replace by	Description
				<i>Press - CTRL + CLICK go to item in a new window Натисніть - Ctrl + права кнопка миші щоб відкрити запчастину в новому вікні</i>
	1		11029674	WATER CONT/TURBINE DRAIN TUBESRYLO ASSY WATER CONT/TURBINE DRAIN TUBESRYLO ASSY
	2		11035450	SILICONE TUBE 5X10 L.2000MM TUBO SILICONE 5X10 TRASP. L.2000MM
	3		147920300	TRANS.CONNECTOR D=8 ART.80.26.047 KA.461 RACCORDO T D=8 ART.80.26.047 KA.461
	4		11032467	SILICONE TUBE 11X12,8 L.2000 MM TUBO SILICONE 11X12.8 L=2000 MM
	5		12000892	ЗАЖИМ D.9,5 16700004 OETIKER CLAMP D=9,5 16700004 (L250)
	6		17004117	220V/BLK PROT+BLOWDOWN VALVE RYLO K AS. 220V/BLK PROT+BLOWDOWN VALVE RYLO K AS.
	7		11028161	BLOWDOWN VALVE V3 RYL 220V-60HZ ASSY. BLOWDOWN VALVE V3 RYL 220V-60HZ ASSY.
	8		11027788	PINK 5X8,9 SILICONE TUBE L=2000MM TUBO SIL.RETIN.5X8.9 L=2000MM ROSA
	9		17004116	SAFETY VALVE/EV DRAIN TUBES RYLO K ASSY. SAFETY VALVE/EV DRAIN TUBES RYLO K ASSY.
	10		17000165	BLACK DRIP TRAY PROTECTION RYL BLACK DRIP TRAY PROTECTION RYL
	11		129913902	SCREW TCB TORX 10 3X12 PLAST.ZN-B SCREW TCB TORX 10 3X12 PLAST.ZN-B
	12		17800442	2POLES CONNECT.SENSOR REED DUMP BOX CST 2POLES CONNECT.SENSOR REED DUMP BOX CST
	13		11001054	СОЕДИНИТЕЛЬНЫЙ УГОЛОК 90° К НАСОСУ P0049/В PHILIPS SAECO 996... BLK PUMP OUTLET 90° CONNECTOR P0049/B

Model Machine

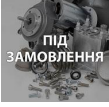
MACSAE218













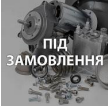



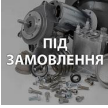



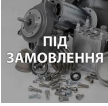

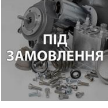

OCS SAE AULIKA TOP HSC SIL 230/50 SCH (10004886)

	14		140321961	ПРОКЛАДКА O-RING ДЛЯ КАВОМАШИНИ SAECO 2031 TERMOIL OR 2031 IN TERMOIL
	15	 ПІД ЗАМОВЛЕННЯ	17004032	BLK COMPONENTS SUPPORT RYLO V2KR BLK COMPONENTS SUPPORT RYLO V2KR
	16	 ПІД ЗАМОВЛЕННЯ	17800202	2POLES CONNECTOR COFFEE PUMP RYL UL 2POLES CONNECTOR COFFEE PUMP RYL UL
	17		11022857	BLACK PUMP SUPPORT GMYB BLACK PUMP SUPPORT GMYB
	18	 ПІД ЗАМОВЛЕННЯ	12000182	ULKA PUMP EP5/S GW 220V-60HZ ULKA PUMP EP5/S GW 220V-60HZ
	19	 ПІД ЗАМОВЛЕННЯ	17004120	2P.CONN.STEAM PUMP V2 RYL UL ASSY. 2P.CONN.STEAM PUMP V2 RYL UL ASSY.
	20		11006304	TEA/BRASS CONNECTOR FOR ALUM.BOILER TEA/BRASS CONNECTOR FOR ALUM.BOILER
	21		9181.350	TEA/BRASS REAR CONNECTOR 1/8"ULKA PUMP TEA/BRASS REAR CONNECTOR 1/8 ULKA PUMP
	22	 ПІД ЗАМОВЛЕННЯ	NM03.017	O-RING R6 NBR OR R6 NBR
	23	 ПІД ЗАМОВЛЕННЯ	9071.054	BRASS NUT FOR ULKA PUMP REAR CONNECTOR BRASS NUT FOR ULKA PUMP REAR CONNECTOR
	24	 ПІД ЗАМОВЛЕННЯ	9079.A37	REAR CONN. ASS. M5 FOR ULKA PUMP REAR CONN. ASS. M5 FOR ULKA PUMP
	25	 ПІД ЗАМОВЛЕННЯ	17004040	COMPONENTS SUPP.ASSY. RYLO V2KR COMPONENTS SUPP.ASSY. RYLO V2KR
	26	 ПІД ЗАМОВЛЕННЯ	17004041	SAFETY VALVE 5 BAR ASSY. SAFETY VALVE 5 BAR ASSY.
	27	 ПІД ЗАМОВЛЕННЯ	11025871	GEN.TURBINE RYLO ASSY. GEN.TURBINE RYLO ASSY.

Model Machine

MACSAE218

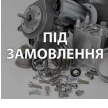





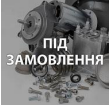

OCS SAE AULIKA TOP HSC SIL 230/50 SCH (10004886)

	28		11010243	TEA/BRASS 90° DOUBLE CONNECTOR <i>TEA/BRASS 90° DOUBLE CONNECTOR</i>
	29	 ПІД ЗАМОВЛЕННЯ	9181.406	TEA/BRASS CONNECTOR TURBINE MF1/4 1/8 <i>TEA/BRASS CONNECTOR TURBINE MF 1/4 1/8</i>
	30		NM01.049	OR ORM 0070-20 SILICONE <i>OR ORM 0070-20 SILICONE</i>
	31	 ПІД ЗАМОВЛЕННЯ	17000821	BLACK TURBINE SUPPORT RYLO <i>BLACK TURBINE SUPPORT RYLO</i>
	32		12000450	SCREW TCBR TORX 10 3,5X12 PLAST.ZN-N <i>SCREW TCBR TORX 10 3,5X12 PLAST.ZN-N</i>
	33	 ПІД ЗАМОВЛЕННЯ	421941294291	IEC CONNECTOR V2 RYL ASSY. <i>IEC CONNECTOR V2 RYL ASSY.</i>
	34		NV99.033	ПЛАСТИКОВА ТУРБИНА ВИСОКОГО ТИСКУ <i>TURBINA DIGMESA IN PLASTICA</i>
	35		17001018	BLACK WATER SUPPLY CONNECTOR RYLO RI <i>BLACK WATER SUPPLY CONNECTOR RYLO RI</i>
	36	 ПІД ЗАМОВЛЕННЯ	NE03.038	BIPOLEAR SWITCH FUSIT C1250AR <i>BIPOLEAR SWITCH FUSIT C1250AR</i>
	37		12001883	CUP SOCKET V3 EN 60320 C 13 <i>CUP SOCKET V3 EN 60320 C 13</i>
	38	 ПІД ЗАМОВЛЕННЯ	17000162	BLACK SOCKET-SWITCH SUPPORT RYL <i>BLACK SOCKET-SWITCH SUPPORT RYL</i>
	39	 ПІД ЗАМОВЛЕННЯ	421946001561	6P.CONN.FLOWMETER V2 RYLO UL ASSY. <i>6P.CONN.FLOWMETER V2 RYLO UL ASSY.</i>
	40	 ПІД ЗАМОВЛЕННЯ	129912104	SCREW TCBR TORX 20 4X10 PLAST.ZN-N <i>SCREW TCBR TORX 20 4X10 PLAST.ZN-N</i>

Model Machine

MACSAE218

OCS SAE AULIKA TOP HSC SIL 230/50 SCH (10004886)

	41	 ПІД ЗАМОВЛЕННЯ	0701.081	SPRING FOR TUBE PRODUCT 1 <i>SPRING FOR TUBE PRODUCT 1</i>
	42		147756562	BLK PROTECTION FOR FOLK SPRINGTUBE D=4 <i>BLK PROTECTION FOR FOLK SPRING TUBE D=4</i>
	43		12001595	TRANSP/WHITE ASPIRATION FILTERMDS <i>TRANSP/WHITE ASPIRATION FILTER MDS</i>
	44		184320200	SPRING HOSE CLAMP D=9,5MM <i>MOLLA STRINGITUBO D=9,5MM</i>
	45		11001513	МЕМБРАНА КЛАПАНА AULIKA, ODEA SAECO <i>GUARNIZ. A MEMBRANA VALV. SCARICO</i>

Model Machine

MACSAE218

OCS SAE AULIKA TOP HSC SIL 230/50 SCH (10004886)

MACSAE218.T.0012

TAVOLA NR. 12 - ARTICOLO OCS SAE AULIKA TOP HSC SIL 230/50 SCH (10004886)

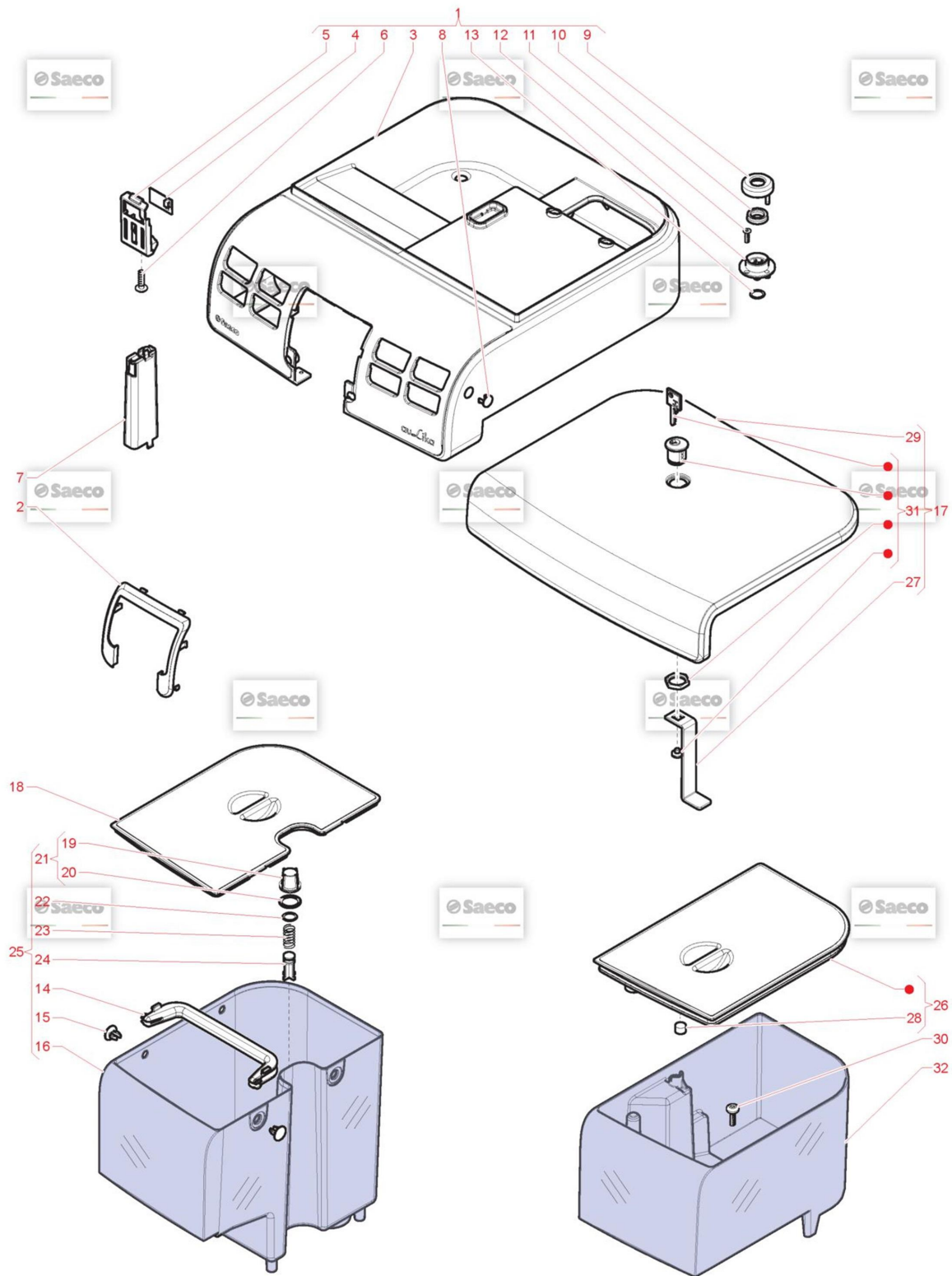

Model Machine

MACSAE218

OCS SAE AULIKA TOP HSC SIL 230/50 SCH (10004886)

Web Pos. Foto Item - Replace by Description



Press - CTRL + CLICK go to item in a new window

Натисніть - Ctrl + права кнопка миші щоб відкрити запчастину в новому вікні



1



11034075

CRC CASING COVER S/SCR.RYLO V2ASSY.
AS.COP.CARC.RYLO V2 CRC SER.



1



11034377

BLK CASING COVER SAE RYLO K-TOP ASSY.
BLK CASING COVER SAE RYLO K-TOP ASSY.



1



11034510

BLK CASING COVER S/SCR.RYLO V2ASSY.
AS.COP.CARC.RYLO V2 BLK SER.



1

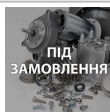

11034802

CRC CASING COVER S/SCR.RYLO V2ASSY. UL
CRC CASING COVER S/SCR.RYLO V2ASSY. UL



1



17004094

KR CRC CASING COVER S/SCR.RYLO/T ASSY.
KR CRC CASING COVER S/SCR.RYLO/T ASSY.



2



11030103

CRC FRONT PANEL RYLO
CRC FRONT PANEL RYLO



3



20007081

SPARES KIT CRC CASING COVER S/SCR.RYLO
SPARES KIT CRC CASING COVER S/SCR.RYLO



3

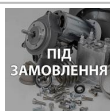

20007780

SPARES KIT CRC CASING COVER RYLO KR
SPARES KIT CRC CASING COVER RYLO KR



3

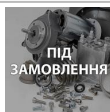

20007781

SPARES KIT CRC CASING COVER RYLO UL
SPARES KIT CRC CASING COVER RYLO UL



3

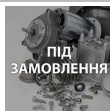

20007782

KIT SPARES TXO/BLK CASING COV/RYLO/T KR
KIT SPARES TXO/BLK CASING COV/RYLO/T KR



3

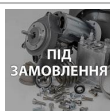

421940813041

KIT SPARES TXO/BLK CASING COV.S/S.RYLO/T
KIT SPARES TXO/BLK CASING COV.S/S.RYLO/T



4

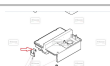

421941306721

ПЛАТА-СЕНСОП РІВНЯ ВОДИ V3 A
CPU+SW WATER LEVEL SENSOR V3 ASSY.



5

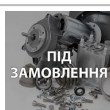



























17001444

BLACK WATER LEVEL SENSOR SUPPORT RYLO
BLACK WATER LEVEL SENSOR SUPPORT RYLO

Model Machine

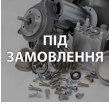
MACSAE218























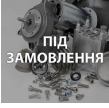

OCS SAE AULIKA TOP HSC SIL 230/50 SCH (10004886)

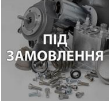
	6		12000450	SCREW TCBR TORX 10 3,5X12 PLAST.ZN-N SCREW TCBR TORX 10 3,5X12 PLAST.ZN-N
	7		17000829	BLACK BEAN CONTAINER SENSOR SUPPORT RYLO BLACK BEAN CONTAINER SENSOR SUPPORT RYLO
	8	 ПІД ЗАМОВЛЕННЯ	17000422	TRANSP.INFRAREDS PLATE RYL TRANSP.INFRAREDS PLATE RYL
	9		0701.031.150	GREY WATER VALVE GACO DIM 14 SEAL COVER SEAL COVER GREY
	10		145842900	NBR WATER CONT.VALVE GACO DIM14 SEAL NBR WATER CONT.VALVE GACO DIM14 SEAL
	11		12000895	SCREW TSP TORX 10 3X10 PLAST.SS SCREW TSP TORX 10 3X10 PLAST.SS
	12		0701.014.150	GREY WATER VALVE GACO DIM 14 SEAL CONT. GREY WATER VALVE GACO DIM 14 SEAL CONT.
	13	 ПІД ЗАМОВЛЕННЯ	140320461	OR ORM 0080-20 TERMOIL OR ORM 0080-20 IN TERMOIL
	14		11025847	BLACK HANDLE WATER CONTAINER LID RYLO BLACK HANDLE WATER CONTAINER LID RYLO
	15		17001255	ЗАТИЧКА 1 ШТ BLACK PLUG FOR WATER CONTAIN.HANDLE RYL
	16	 ПІД ЗАМОВЛЕННЯ	11029967	TRANSP/GREY WATER CONTAINER S/SCR.RYLO TRANSP/GREY WATER CONTAINER S/SCR.RYLO
	17	 ПІД ЗАМОВЛЕННЯ	11025835	CRC W/LOCK CONTAINERS LID RYLOASSY. CRC W/LOCK CONTAINERS LID RYLO ASSY.
	17	 ПІД ЗАМОВЛЕННЯ	421941301071	TXO/BLK W/LOCK CONTAINERS LIDRYLO ASSY. AS.COP.CONT.C/SERRATURA RYLO NER/TXO
	18		11025848	BLACK WATER CONTAINER LID RYLO COPERCHIO.CONTENTITORE.ACQUA.NERO LID RYLO

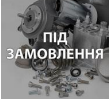
Model Machine

MACSAE218

OCS SAE AULIKA TOP HSC SIL 230/50 SCH (10004886)

	19		144650800	WHITE WATER CONTAINER EXT.FILTER <i>WHITE WATER CONTAINER EXT.FILTER</i>
	20		140328461	ПРОКЛАДКА O-RING 0190-10 ДЛЯ КОФЕМАШИНЫ PHILIPS SAECO 99653... <i>OR METRICO 0190-10 IN EPDM NUOVO PREZZO 0,13</i>
	21		224640200	БІЛИЙ ПЛАСТИКОВИЙ ФІЛЬТР У КОНТЕЙНЕР ВОДИ SAECO 996530029115 <i>EXTERNAL FILTER FOR WATER CONTAINER ASSY</i>
	22		140324362	OR ORM 0060-30 SILICONE <i>OR METRIC 0060-30 IN SILICONE</i>
	23		126764718	SS WATER CONTAINER VALVE SPRING <i>SS WATER CONTAINER VALVE SPRING</i>
	24		147660562	GREY PISTON FOR WATER CONTAINER VALVE <i>GREY PISTON FOR WATER CONTAINER VALVE</i>
	25		11025846	TRANSP/GREY WATER CONTAINER RYLO ASSY. <i>NAT/GREY WATER CONTAINER RYLO ASSY.</i>
	26		11025844	BLACK BEAN COFFEE CONTAIN.LIDRYLO ASSY. <i>BLACK BEAN COFFEE CONTAIN.LID RYLO ASSY.</i>
	27		17001987	STEEL CONTAINERS LID LOCK BRACKET RYLO <i>STEEL CONTAINERS LID LOCK BRACKET RYLO</i>
	28		11004160	D=6 H=4 MAGNET P0049 <i>D=6 H=4 MAGNET P0049</i>
	29		11025829	CRC CONTAINERS LID RYLO TO ASSY. <i>CRC CONTAINERS LID RYLO TO ASSY.</i>
	29		421941301061	TXO/BLK CONTAINERS LID RYLO TO ASSY. <i>TXO/BLK CONTAINERS LID RYLO TO ASSY.</i>
	30		12001431	SCREW TCB TORX 10 3X12 PLAST.SS <i>SCREW TCB TORX 10 3X12 PLAST.SS</i>

Model Machine

MACSAE218

OCS SAE AULIKA TOP HSC SIL 230/50 SCH (10004886)



31



12001902

ЛИЧИНКА ЗАМКА MERONI 337
LOCK MERONI 337



32



11025841

TRANSP/GREY BEAN CONTAINER RYLO
NAT/GREY BEAN CONTAINER RYLO

Model Machine

MACSAE218

OCS SAE AULIKA TOP HSC SIL 230/50 SCH (10004886)

MACSAE218.T.0013



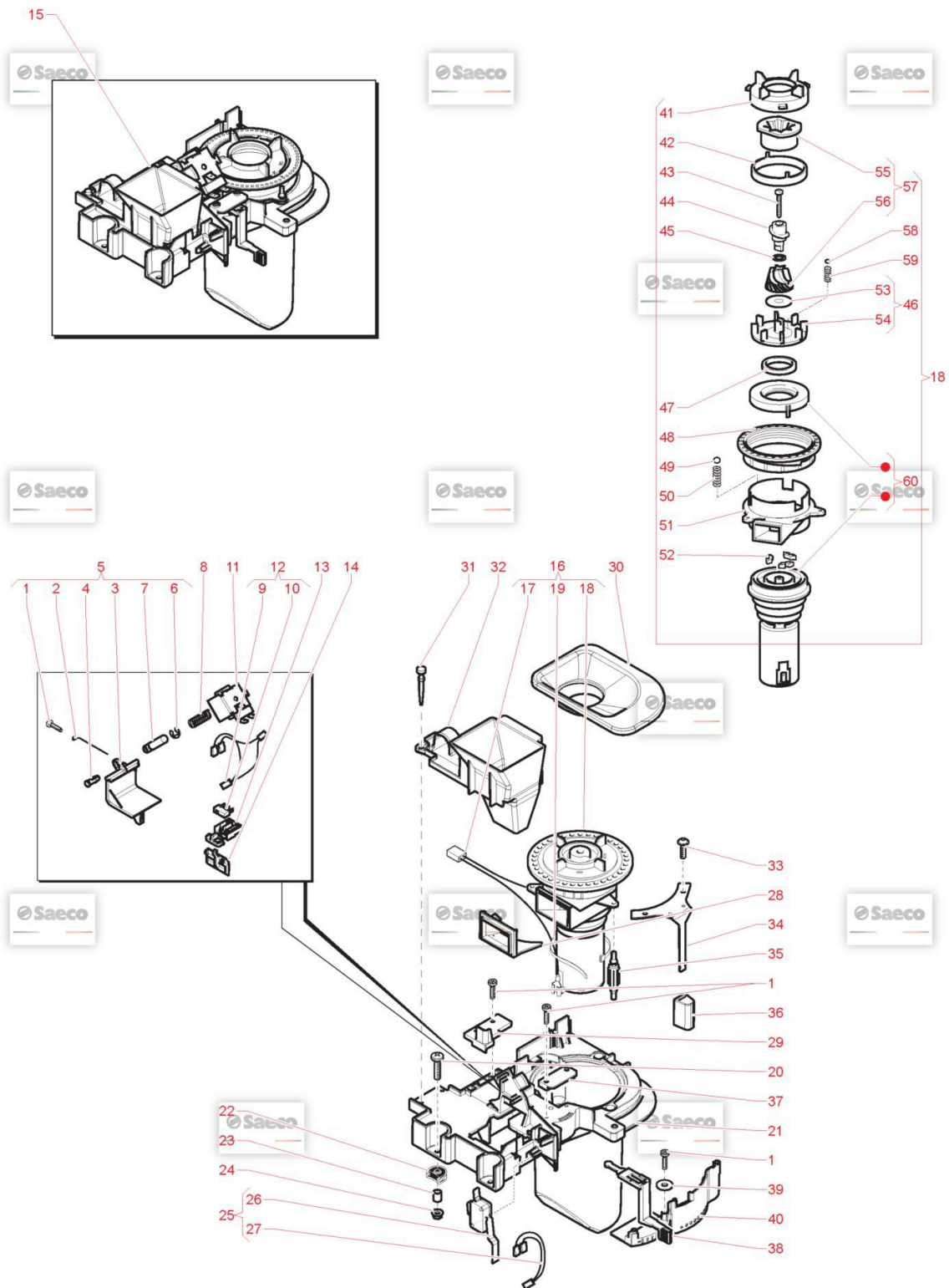

















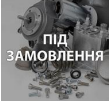





TAVOLA NR. 13 - ARTICOLO OCS SAE AULIKA TOP HSC SIL 230/50 SCH (10004886)

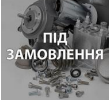

Model Machine

MACSAE218

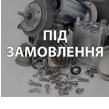











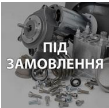













OCS SAE AULIKA TOP HSC SIL 230/50 SCH (10004886)

Web	Pos.	Foto	Item - Replace by	Description
				<i>Press - CTRL + CLICK go to item in a new window Натисніть - Ctrl + права кнопка миші щоб відкрити запчастину в новому вікні</i>
	1		129913902	SCREW TCB TORX 10 3X12 PLAST.ZN-B SCREW TCB TORX 10 3X12 PLAST.ZN-B
	2		9161.048	STEEL GROUND COF.DOSER SCRAPERROD ASTA RASATORE
	3		9161.074.150	GREY GROUND COFFE DOSER DOOR SPORTELLO DOSATORE GRIGIO
	4		9161.076.150	GREY GROUND COF.DOSER DOOR PIN PERNO SPORTELLO DOSATORE GRIGIO
	5	 ПІД ЗАМОВЛЕННЯ	9140.017	GREY GROUND COF.DOSER DOOR ASSY. DOSER DOOR ASSEMBL.GREY
	6		U701.003	SNAP RING 7 UNI 7434 ANELLO ELASTICO 7 UNI 7434
	7		9161.041	STEEL GROUND COF.DOSER ELECTROMAGN.CORE NUCLEO ELETTRROMAGNETE DOSATORE
	8		126764818	ПРУЖИНА ЕЛЕКТРОМАГНІТНОГО ДОЗАТОРА ЗЕРНА MAGIC SAECO 916... SPRING ELECTROM.BEAN DOSER MAGIC
	9	 ПІД ЗАМОВЛЕННЯ	421946000541	4P.CONN.COIL+DOSER MICRO V2 RYL UL ASSY. 4P.CONN.COIL+DOSER MICRO V2 RYL UL ASSY.
	10		NE05.017	MICROSWITCH MICROSWITCH NE05.017
	11		11025734	DOSER COIL FOR SUPERAUTOM.24VDC ASSY. DOSER COIL FOR SUPERAUTOM.24V DC ASSY.
	12	 ПІД ЗАМОВЛЕННЯ	421946000921	COIL WIRING+DOSER MICRO V2 RYLUL ASSY. COIL WIRING+DOSER MICRO V2 RYLUL ASSY.
	13		9161.072.150	GREY MICRO SUPP.CURSOR GROUND COF.DOSER MICRO SUPPORT CURSOR GREY

Model Machine

MACSAE218



























OCS SAE AULIKA TOP HSC SIL 230/50 SCH (10004886)

	14		9161.073.150	GREY GROUND COF.DOSE CONTROL COMPENSATOR <i>DOSE CONTROL COMPENSATOR GREY</i>
	15	 ПІД ЗАМОВЛЕННЯ	11029886	PLATE COFFEE GRINDER GEN.RYLO230V ASSY. <i>AS.GEN.PIAS.MC RYLO 230V</i>
	15	 ПІД ЗАМОВЛЕННЯ	421944015031	PLATE COF.GRINDER GEN.RYLO 120V ASSY. <i>PLATE COF.GRINDER GEN.RYLO 120V ASSY.</i>
	16	 ПІД ЗАМОВЛЕННЯ	11027917	COFFEE GRINDER STD CALIBRATED230V ASSY. <i>AS.MACINACAFFE STD TARATO 230V</i>
	16	 ПІД ЗАМОВЛЕННЯ	11028181	COFFEE GRINDER STD CALIBRATED120V ASSY. <i>AS.MACINACAFFE STD TARATO 120V</i>
	17	 ПІД ЗАМОВЛЕННЯ	421946000531	2P.CONN.GRINDER MOTOR V2 RYL UL ASSY. <i>2P.CONN.GRINDER MOTOR V2 RYL UL ASSY.</i>
	18		9140.036.00A	КАВОМОЛКА В ЗБОРІ 230V PHILIPS SAECO 996530065687 <i>COFFEE GRINDER STD 230V ASSY.</i>
	18	 ПІД ЗАМОВЛЕННЯ	9140.036.00F	ASS.MOTOR STD 120V <i>ASS.MOTOR STD 120V</i>
	19	 ПІД ЗАМОВЛЕННЯ	144320200	SELF LOCK STRIP W=2.6 L=200 <i>SELF LOCK STRIP W=2.6 L=200</i>
	20		U043.004	ZN-B TCB TORX 20 M4X16 ZN-B <i>VITE TCBC M4,0X16 UNI 7687 ZNP</i>
	21		9161.365.150	GREY PLATE COFFEEGRINDER MAGIC/ROYAL <i>PIASTRA X MACINACAFFE' GRIGIO/7016</i>
	22		9991.005	RUBBER FOR COFFEE GRINDER <i>GOMMINO X MACINA CAFFE</i>
	23		9141.003	SPACER FOR RUBBER <i>SPACER FOR RUBBER</i>
	24		U324.006	ШАЙБА M4 <i>NUT M4 FLANGED INDENTED BASE</i>

Model Machine

MACSAE218











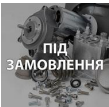



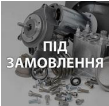











OCS SAE AULIKA TOP HSC SIL 230/50 SCH (10004886)

	25		421946000911	MICROSWITCH DOOR V2 RYL UL ASSY. <i>AS.MICRO SPORT.V2 RYL UL</i>
	26		12001605	МІКРИК <i>MICROSWITCH</i>
	27		421946000501	2P.CONN.DOOR MICRO V2 RYL UL ASSY. <i>2P.CONN.DOOR MICRO V2 RYL UL ASSY.</i>
	28		1505.014	COFFEEGRINDER SEAL <i>GUARNIZIONE DOSATORE</i>
	29		17001155	GREY COVER FOR DOSER HOLE RYL <i>GREY COVER FOR DOSER HOLE RYL</i>
	30		17000238	COFFEE GRINDER SOUNDPROOFING COVER RYL <i>COFFEE GRINDER SOUNDPROOFING COVER RYL</i>
	31		9161.082	RUBBER COUPLER <i>AGGANCIO IN GOMMA</i>
	32		17000176	BLACK HOPPER FOR POWDER COFFEERYL <i>BLACK HOPPER FOR POWDER COFFEE RYL</i>
	33		12000450	SCREW TCBR TORX 10 3,5X12 PLAST.ZN-N <i>SCREW TCBR TORX 10 3,5X12 PLAST.ZN-N</i>
	34		0333.008	STEEL GRINDING ADJUSTMENT LEVER <i>STEEL GRINDING ADJUSTMENT LEVER</i>
	35		9991.103	АМОТИЗАТОР ДЛЯ КОФЕМОЛКИ КОФЕМАШИН PHILIPS SAECO 996530... <i>AMMORTIZZATORE PER MACINACAFE</i>
	36		0333.009	BLK GRINDING ADJUST.LEVER HANDGRIP ROYAL <i>BLK GRINDING ADJUST.LEVER HANDGRIP ROYAL</i>
	37		9161.097.150	GREY GROUND COF.DOSER LEVER FIXING PLATE <i>LEVER FIXING PLATE GREY</i>

Model Machine

MACSAE218













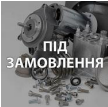



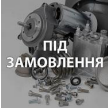

OCS SAE AULIKA TOP HSC SIL 230/50 SCH (10004886)

	38	 ПІД ЗАМОВЛЕННЯ	9161.077.150	DOSE ADJUSTMENT LEVER DE LUXEGREY <i>DOSE ADJUSTMENT LEVER DE LUXE GREY</i>
	39		U201.001	PLAIN WASHER 3,2X9 DIN 7349 GALV. <i>PLAIN WASHER 3,2X9 DIN 7349 GALV.</i>
	40	 ПІД ЗАМОВЛЕННЯ	17000832	GRY COFF.GRINDING/DOSE ADJUST.SCALE RYLO <i>GRY COFF.GRINDING/DOSE ADJUST.SCALE RYLO</i>
	41		149186150	BLACK UPPER GRINDER SUPPORT MAGIC <i>SUPPORT.NER.X MACINA SUPERIO</i>
	42		142844550	UPPER GRINDER COVER COFFEE GRIND. MAGIC <i>UPPER GRINDER COVER COFFEE GRIND. MAGIC</i>
	43	 ПІД ЗАМОВЛЕННЯ	129931002	TORX SCREW T10 TCB 3,5X40 SX ZNG <i>TORX SCREW T10 TCB 3,5X40 SX ZNG</i>
	44		147470763	BLK INCREASE SCREW PIN COF.GRINDER MAGIC <i>PERNO INCREM.A VITE X MACINA</i>
	45		U201.002	PLAIN WASHER 10X16X0,2DIN 988GAL <i>ROSETTA PIANA 10X16X0,2DIN</i>
	46	 ПІД ЗАМОВЛЕННЯ	149188750	CONICAL GRIND. SUPP. + RING MAGIC <i>CONICAL GRIND. SUPP. + RING MAGIC</i>
	47		140360200	FELT RING 40X34X5 <i>ANELLO IN FELTRO DE=40 DI=34</i>
	48		146570950	RING NUT FOR GRINDING ADJUSTMENT MAGIC <i>GHIERA NERA REGOLAZ.MACINATU</i>
	49		128610421	STAIL.STELL AISI 304 SPHERE D=3,2MM <i>SFERA D=3,2MM ACCIAIO INOX A</i>
	50		126770117	NEW SPRING SPHERE D=3,2 MOTORMAGIG <i>MOLLA NEW X SFERA D=3,2 MOTORE MAGIC</i>
	51	 ПІД ЗАМОВЛЕННЯ	9141.080	ТРИМАЧ ДВИГУНА КАВОМОЛКИ ДЛЯ КАВОВАРКИ SAECO 9141.080 <i>SUPPORTO MOTORE</i>

Model Machine

MACSAE218

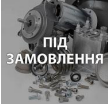
OCS SAE AULIKA TOP HSC SIL 230/50 SCH (10004886)

	52		140230400	SHOCK ABS .CONICAL GRINDER SUPP.MAGIC <i>AMMORTIZ.X SUPPOR.MACIN.CONI</i>
	53	 ПІД ЗАМОВЛЕННЯ	9141.042	SAFETY RING <i>SAFETY RING</i>
	54	 ПІД ЗАМОВЛЕННЯ	9141.028	BLACK LOWER GRINDER SUPPORT MAGIC <i>BLACK LOWER GRINDER SUPPORT MAGIC</i>
	55	 ПІД ЗАМОВЛЕННЯ	9141.039	UPPER GRINDER <i>UPPER GRINDER</i>
	56		9141.040	CONICAL GRINDER <i>CONICAL GRINDER</i>
	57		226477700	KIT ITAL MILL GRINDERS <i>COPPIA DI MACINE SAECO CONICHE</i>
	58		128610521	STAIL.STEEL AISI 304 SPHERE D=5,5MM <i>SFERA D=5,5MM ACCIAIO INOX A</i>
	59		126765517	STEEL SPRING SPHERE D=5,5 MOTOR MAGIC <i>MOLLA ACC.X SFERA D=5,5 MOTO</i>
	60	 ПІД ЗАМОВЛЕННЯ	0301.R10.00A	SPARE MOTOR UNIT MC 230V <i>GRUPPO RICAMBIO MOTORE MC 230 V</i>
	60		0301.R10.00F	SPARE MOTOR UNIT MC 120V <i>SPARE MOTOR UNIT MC 120V</i>

Model Machine

MACSAE218

OCS SAE AULIKA TOP HSC SIL 230/50 SCH (10004886)

MACSAE218.T.0014

TAVOLA NR. 14 - ARTICOLO OCS SAE AULIKA TOP HSC SIL 230/50 SCH (10004886)

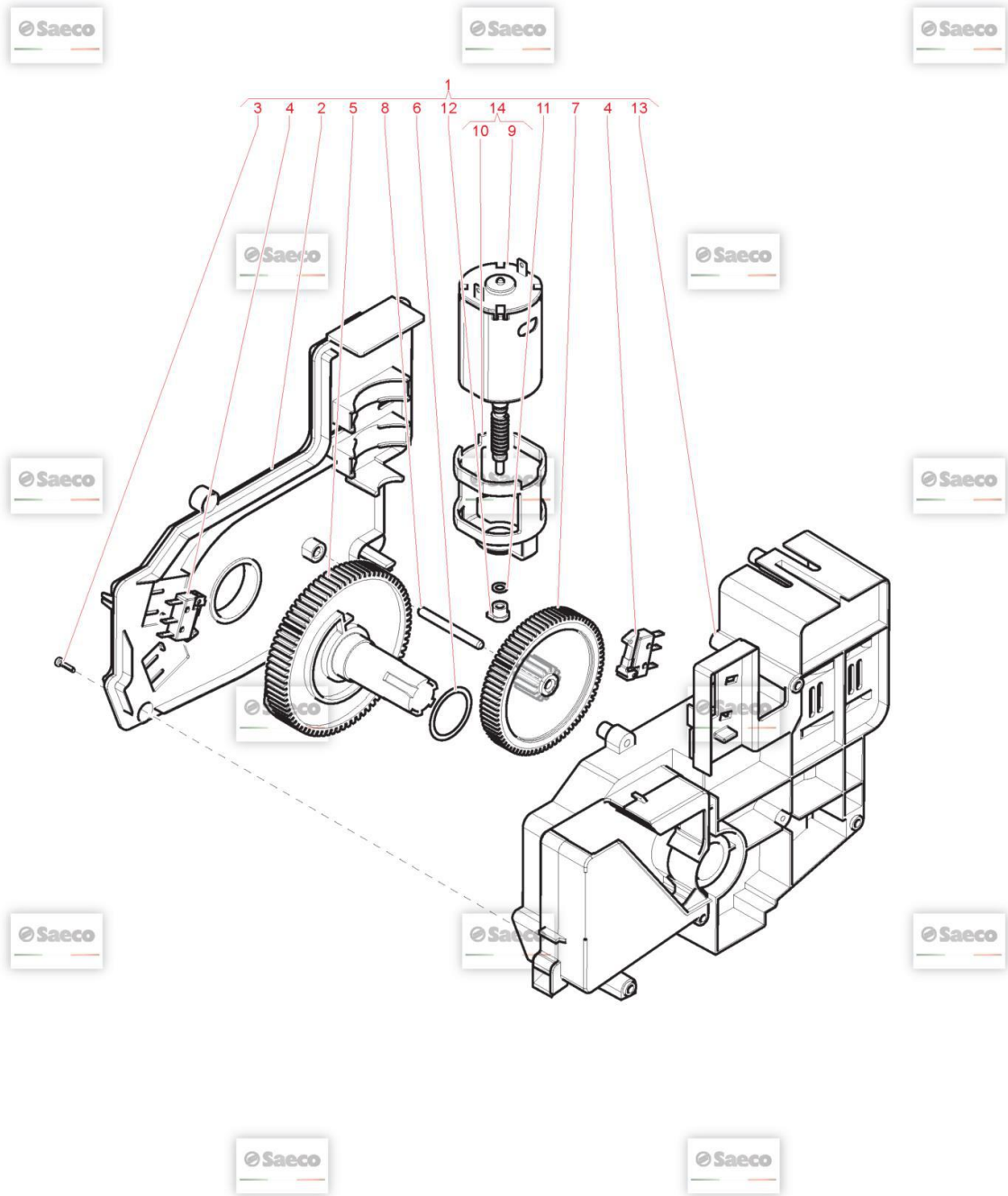

Model Machine

MACSAE218

OCS SAE AULIKA TOP HSC SIL 230/50 SCH (10004886)

Web Pos. Foto Item - Replace by Description



Press - CTRL + CLICK go to item in a new window
Натисніть - Ctrl + права кнопка миші щоб відкрити запчастину в новому вікні



1



11025736

РЕДУКТОР ВЗБОРИ PHILIPS SAECO 996530068554
RATIOMOTOR RYL ASSY.



2



17000719

GREY RATIOMOTOR LID RYL
GREY RATIOMOTOR LID RYL



3



129670202

TCB PANELVIT SCREW 3,5X16 TESTA D=8 ZNP
TCB PANELVIT SCREW 3,5X16 TESTA D=8 ZNP



4



NE05.038

MICROSWITCH 30V 0.3A
MICROINTERRUTTORE



5

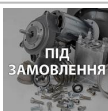

11007137

BLACK GEAR Z=77 V2 FOR RATIOMOTOR P124
BLACK GEAR Z=77 V2 FOR RATIOMOTOR P124



6



9161.368

MYLAR WASHER FOR RATIOMOTOR
RONDELLA MYLAR X MOTORIDUTTORE



7



146002800

GREY GEAR Z=13/90 FOR RATIOMOTOR P124
GREY GEAR Z=13/90 FOR RATIOMOTOR P124



8

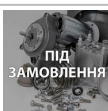

9121.039

STEEL PIN FOR RATIOMOTOR GEARMAGIC
STEEL PIN FOR RATIOMOTOR GEARMAGIC



9

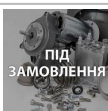

11003037

MOTOR FOR RATIOMOTOR ASSY.
MOTOR FOR RATIOMOTOR ASSY.



10



9121.044

ANTIVIBRATION FOR MOTOR
ANTIVIBRANTE X MOTORE



11



148380200

BAKELIZZATE WASHER D=5,5
BAKELIZZATE WASHER D=5,5



12



9121.046

МЕТАЛИЧНА НАКЛАДКА ДЛЯ МОТОРА
BRONZE SINTERED BUSH FOR MOTOR RATIOMOT.



13



11026258

GREY RATIOMOTOR CASING WITH TUBE ASSY.
GREY RATIOMOTOR CASING WITH TUBE ASSY.

Model Machine

MACSAE218

OCS SAE AULIKA TOP HSC SIL 230/50 SCH (10004886)



14



11005214

MOTOR FOR RATIOMOTOR ASSY.

MOTOR FOR RATIOMOTOR P124 ASSY

Model Machine

MACSAE218

OCS SAE AULIKA TOP HSC SIL 230/50 SCH (10004886)

MACSAE218.T.0015



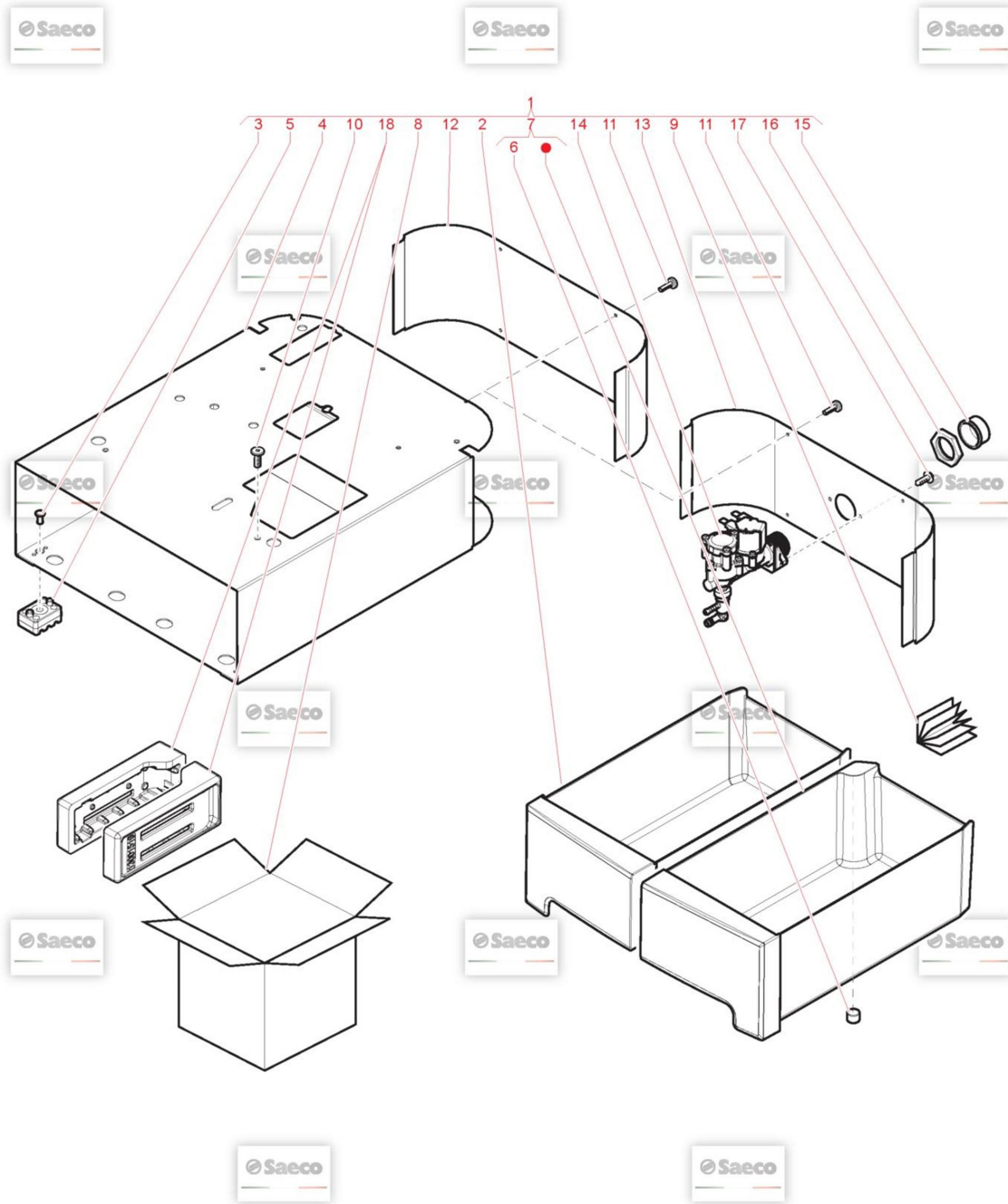











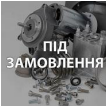

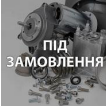

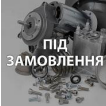





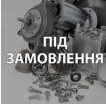

TAVOLA NR. 15 - ARTICOLO OCS SAE AULIKA TOP HSC SIL 230/50 SCH (10004886)

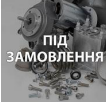

Model Machine

MACSAE218

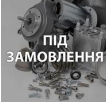









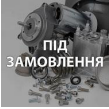

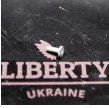



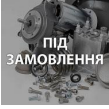

OCS SAE AULIKA TOP HSC SIL 230/50 SCH (10004886)

Web	Pos.	Foto	Item - Replace by	Description
				<i>Press - CTRL + CLICK go to item in a new window Натисніть - Ctrl + права кнопка миші щоб відкрити запчастину в новому вікні</i>
	1		11029676	ЧОРНИЙ ПІДДОН В ЗБОРІ З СРІБНИМИ ШУХЛЯДКАМИ BLACK/CRC BASE RYLO ASSY.
	1		11030450	BLACK/CRC BASE RYLO RI ASSY. BLACK/CRC BASE RYLO RI ASSY.
	1		11034378	BLK/TXO BASE RYLO RI ASSY. BLK/TXO BASE RYLO RI ASSY.
	1		421944010861	BLK-TXO/BLK BASE RYLO ASSY. BLK-TXO/BLK BASE RYLO ASSY.
	2		11029731	CRC BASE REPOSITORY DRAWER RYLO CRC BASE REPOSITORY DRAWER RYLO
	2		421941302441	ШУХЛЯДА ЛІВА, ЧОРНА ДЛЯ БАЗОВОЇ ПІДСТАВКИ TXO/BLK BASE REPOSITORY DRAWER RYLO
	3		11021769	BLACK RIGID FOOT FIXING PIN MYB9 BLACK RIGID FOOT FIXING PIN MYB9
	4		421946005111	BLK STEEL BASE CASING V2 RYLO ASSY. BLK STEEL BASE CASING V2 RYLO ASSY.
	5		11021829	ФІКСУЮЧИЙ НІС НИЖНІЙ ЧАСТИНІ КОРПУСУ (НІЖКИ) PHILIPS SAECO 9... BLACK/TRANSP.RIGID FOOT MYB9
	6		9161.111	MAGNET FOR FLOAT SUPERAUT. MAGNET FOR FLOAT SUPERAUT.
	7		11029719	CRC BASE DUMP BOX RYLO ASSY. CRC BASE DUMP BOX RYLO ASSY.
	7		421941302531	TXO/BLK BASE DUMP BOX RYLO ASSY. TXO/BLK BASE DUMP BOX RYLO ASSY.
	8		13001676	HAVANA BOX V2 BASE RYLO HAVANA BOX V2 BASE RYLO

Model Machine

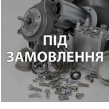
MACSAE218

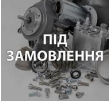
OCS SAE AULIKA TOP HSC SIL 230/50 SCH (10004886)

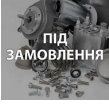
	9		15003922	MANUAL SAE SUP040R RYLO RI 17LANG. MANUAL SAE SUP040R RYLO RI 17LANG.
	10		129914302	SCREW TORX M4X10 TESTA D=8X1,5 GALV SCREW TORX M4X10 TESTA D=8X1,5 GALV
	11		12001622	SCREW TCB TORX B 3,5X9,5 SCHEET NIK SCREW TCB TORX B 3,5X9,5 SCHEET NIK
	12		421944001181	BLK BASE REAR PANEL RYLO BLK BASE REAR PANEL RYLO
	13		11029701	BLACK BASE REAR PANEL RYLO RI BLACK BASE REAR PANEL RYLO RI
	14		17001582	НАДЛИШКОВИЙ КЛАПАН ВИСОКОГО ТИСКУ SAECO SS-7117001582 CONNECT.WATER SUPPLY RYLO RI ASSY.
	15		NV03.002	КРИШКА КЛАПАНА ПОДАЧІ ВОДИ 3/4 "CAP 3/4 "KAPSTO 800R 3/4""
	16		NV99.075	GHIERA IN NYLON G3/4" 6 MM. "GHIERA IN NYLON G3/4" 6 MM.
	17		129912104	SCREW TCBR TORX 20 4X10 PLAST.ZN-N SCREW TCBR TORX 20 4X10 PLAST.ZN-N
	18		13001519	PS-E INSERT FOR BOX BASE RYLO PS-E INSERT FOR BOX BASE RYLO

Model Machine

MACSAE218

OCS SAE AULIKA TOP HSC SIL 230/50 SCH (10004886)

MACSAE218.T.0016



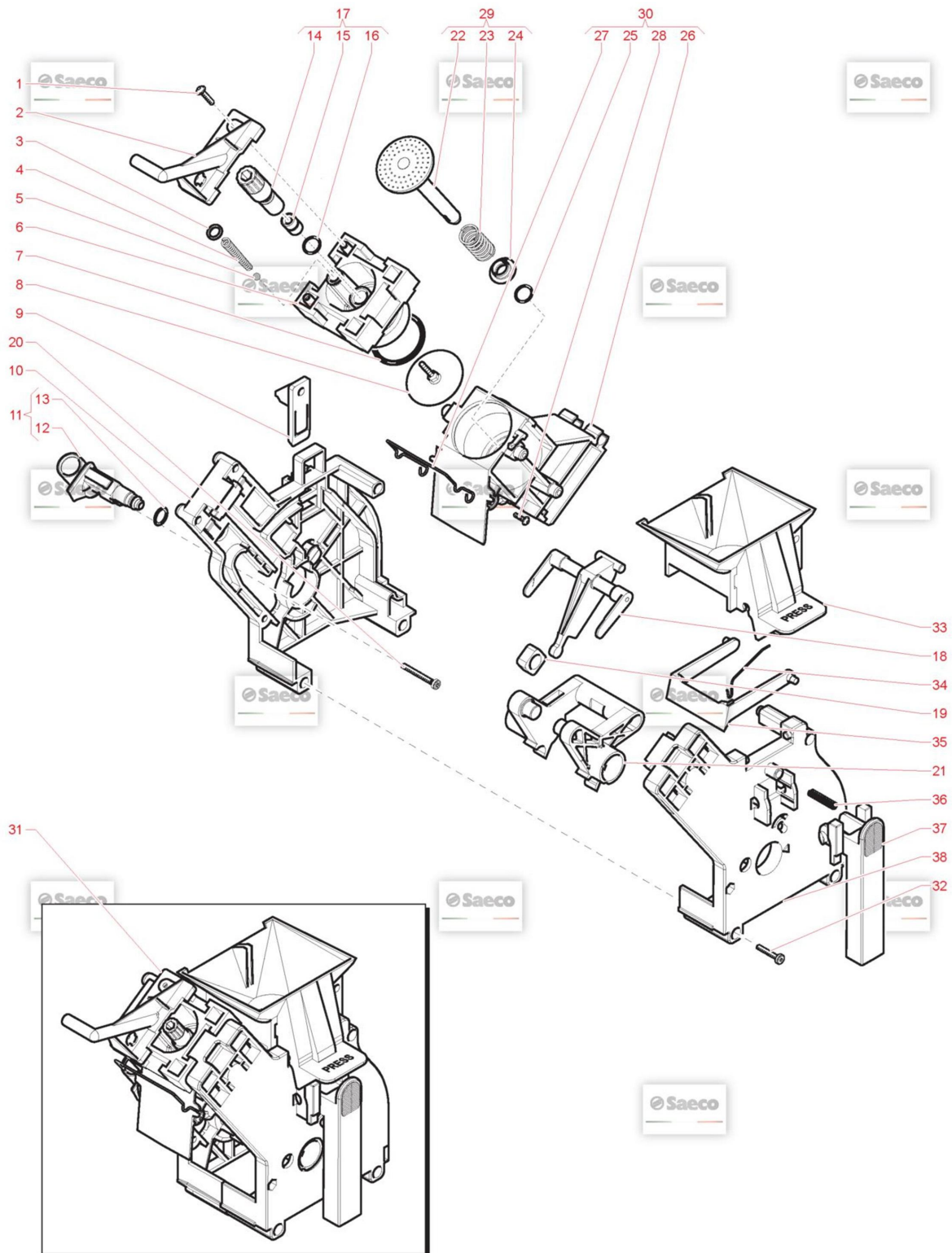























TAVOLA NR. 16 - ARTICOLO OCS SAE AULIKA TOP HSC SIL 230/50 SCH (10004886)



Model Machine

MACSAE218











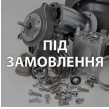

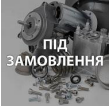











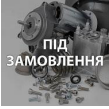

OCS SAE AULIKA TOP HSC SIL 230/50 SCH (10004886)

Web	Pos.	Foto	Item - Replace by	Description
				<i>Press - CTRL + CLICK go to item in a new window Натисніть - Ctrl + права кнопка миші щоб відкрити запчастину в новому вікні</i>
	1		12002170	SCREW TCB TORX 10 3X16 PLAST SS VITE TCB 3X16 TORX 10 PLAST.INOX
	2		11003789	BLACK COFF.OUTLET SLEEVE BREWUNIT ROYAL BLACK COFF.OUTLET SLEEVE BREW UNIT ROYAL,AULIKA MAGIC SAECO
	3		11021334	BLK COUNTERPISTON SEAL DE=11 DI=8 SP=1,4 BLK COUNTERPISTON SEAL DE=11 DI=8 SP=1,4
	4		9161.222	SS.CONICAL SPRING MOLLA CONICA
	5	 ПІД ЗАМОВЛЕННЯ	421944034451	BOROSILICATE SPHERE D.5 MM BOROSILICATE SPHERE D.5
	6		11003796	BLACK BREW UNIT COUNTERPISTONM5000 BLACK BREW UNIT COUNTERPISTON M5000
	7		NM01.044	OR ORM 0320-40 SILICONE PTFE/FDA OR ORM 0320-40 SILICONE PTFE
	8		9160.075	PERCOLATOR DE=35,8 ELFO ASSY. PERCOLATOR DE=35,8 ELFO ASSY.
	9	 ПІД ЗАМОВЛЕННЯ	11004114	BLACK BREW UNIT COUPLING PLATE BLACK BREW UNIT COUPLING PLATE
	10	 ПІД ЗАМОВЛЕННЯ	421941158532	BLACK BREW UNIT REAR PLATE V2M5000 BLACK BREW UNIT REAR PLATE V2 M5000
	11		20000440	BLACK WATER INLET SLEEVE BREWUNIT ASSY. BLACK WATER INLET SLEEVE BREW UNIT ASSY.
	12		9161.064.050	ВХІДНИЙ КЛАПАН ЗАВАРЮВАЛЬНОГО БЛОКУ КАВОВАРКИ SAECO BLACK WATER INLET SLEEVE BREW UNIT ROYAL
	13		NM02.007	OR 2025 IN TERMOIL OR 2025 TERMOIL

Model Machine

MACSAE218













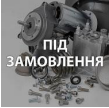







OCS SAE AULIKA TOP HSC SIL 230/50 SCH (10004886)

	14		147472650	PIN BLACK FOR PERCOLATOR <i>PIN BLACK FOR PERCOLATOR</i>
	15		NF11.067	BRASS INSERT FOR PERCOLATOR LOCKING PIN <i>BRASS INSERT FOR PERCOLATOR LOCKING PIN</i>
	16		140324461	OR ORM 0060-20 TERMOIL <i>OR ORM 0060-20 IN TERMOIL</i>
	17		227470150	PIN BLACK ASS.FOR PERCOLATOR <i>PIN BLACK ASS.FOR PERCOLATOR</i>
	18		11003078	BLACK CONNECTING ROD BREW UNIT8GR. <i>BLACK CONNECTING ROD BREW UNIT 8GR.</i>
	19		9161.094.050	ЧОРНИЙ КВАДРАТ В РОБОЧУ ГРУППУ <i>BLACK BREW UNIT DRILLED BLOCK</i>
	20		12000550	САМОПІЗ TCB TORX 10 3X25 PLAST.SS <i>SCREW TCB TORX 10 3X25 PLAST.SS</i>
	21		9161.066.050	ВАЛ РОБОЧОЇ ГРУПИ M5000 SAECO GAGGIA (EX 9161.066.150) <i>BLACK BREW UNIT ELBOW SHAFT M5000</i>
	22		11003077	BLK BREW UNIT INTEGRAL PISTON8GR.ASSY. <i>BLK BREW UNIT INTEGRAL PISTON 8GR.ASSY.</i>
	23		9161.198	SS.8GR.BREW UNIT PISTON SPRING <i>SS.8GR.BREW UNIT PISTON SPRING</i>
	24		9161.191	WHITE 8GR.-12GR.BREW UNIT PISTON BUSH <i>BOCCOLA X PISTONE NEUTRO</i>
	25		NM02.018	OR ORM 0090-25 TERMOIL <i>OR ORM 0090-25 TERMOIL</i>
	26		421944014611	BLK COF.CONTAIN.BREW UNIT V2 M5000 ASSY. <i>BLK COF.CONTAIN.BREW UNIT V2 M5000 ASSY.</i>
	27		11001556	SS BREW UNIT SPRING H=49 SMART <i>SS BREW UNIT SPRING H=49 SMART</i>

Model Machine

MACSAE218

OCS SAE AULIKA TOP HSC SIL 230/50 SCH (10004886)

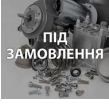
	28		129912521	SCREW TCBR TORX 10 3,5X14 PLAST.SS SCREW TCBR TORX 10 3,5X14 PLAST.SS
	29	 ПІД ЗАМОВЛЕННЯ	11023086	BLK 8GR.BREW UNIT NTEGR.PISTONGEN.ASSY. BLK 8GR.BREW UNIT NTEGR.PISTON GEN.ASSY.
	30	 ПІД ЗАМОВЛЕННЯ	11004570	BLACK BREW UNIT COFFEE CONT.P124 ASSY. AS.CONT.CAF.GRUP.8G.P124 NER.
	31	 ПІД ЗАМОВЛЕННЯ	11003800	BLACK BREW UNIT BLACK BREW UNIT MAGIC/ROYAL
	32	 ПІД ЗАМОВЛЕННЯ	12000897	SCREW TCB TORX 10 3,5X20 PLAST.SS SCREW TCB TORX 10 3,5X20 PLAST.SS
	33	 ПІД ЗАМОВЛЕННЯ	11003795	BLACK HOPPER COFF.BREW UNIT S/SCR.M5000 BLACK HOPPER COFF.BREW UNIT S/SCR.M5000
	34		9161.046	ПРУЖИНА ВОРОНКИ ЗАВАРОЧНОГО БЛОКА ДЛЯ КОФЕМАШИН PHILIPS ... MOLLA X RASATORE GRUPPO
	35		11004161	BLACK SCRAPER FOR BREW UNIT M5000 BLACK SCRAPER FOR BREW UNIT M5000
	36	 ПІД ЗАМОВЛЕННЯ	11003793	BLACK BREW UNIT FRONT PLATE M5000 BLACK BREW UNIT FRONT PLATE M5000
	37		9161.045	SS BREW UNIT HANDGRIP SPRING M5000 MOLLA X IMPUGNATURA GRUPPO
	38	 ПІД ЗАМОВЛЕННЯ	11003791	BLACK BREW UNIT HANDGRIP M5000 BLACK BREW UNIT HANDGRIP M5000

Model Machine

MACSAE218

OCS SAE AULIKA TOP HSC SIL 230/50 SCH (10004886)

MACSAE218.T.0017

TAVOLA NR. 17 - ARTICOLO OCS SAE AULIKA TOP HSC SIL 230/50 SCH (10004886)

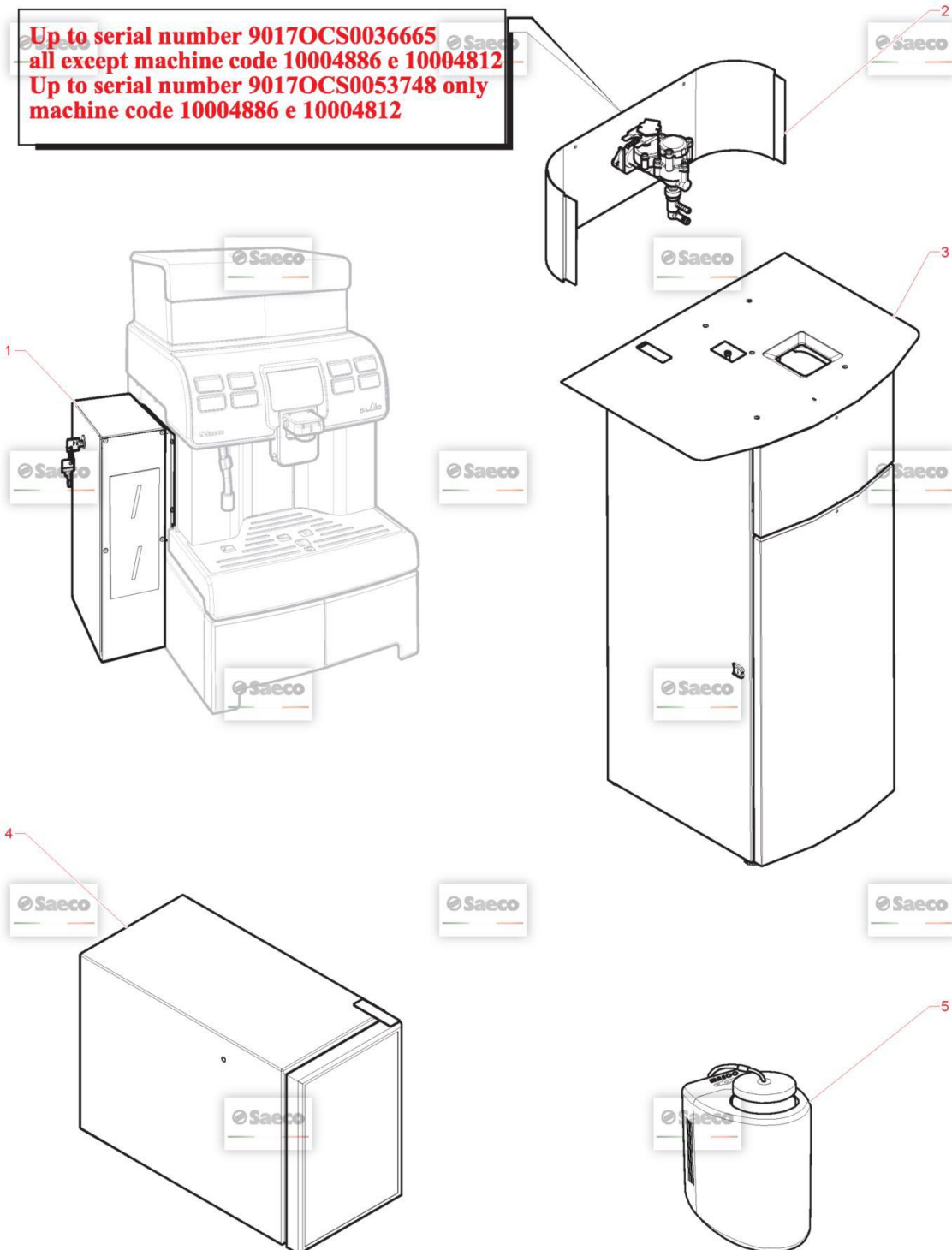

Model Machine

MACSAE218

OCS SAE AULIKA TOP HSC SIL 230/50 SCH (10004886)

Web Pos. Foto Item - Replace by Description



*Press - CTRL + CLICK go to item in a new window
Натисніть - Ctrl + права кнопка миші щоб відкрити запчастину в новому вікні*



1

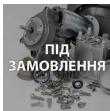

21002350

VE KIT BOX PAYM. SYS. AULIKA TOP HSC
VE KIT BOX PAYM. SYS. AULIKA TOP HSC



2



20007241

KIT WATER SUPPLY AULIKA
KIT WATER SUPPLY AULIKA



3

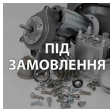

10005004

VE CABINET AULIKA-ROYAL-AMBRABLK-SIL
VE CABINET AULIKA-ROYAL-AMBRABLK-SIL



4

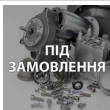

21001800

ACC PR FRIGO ASTRA 220/230 50/60 SCH BLK
ACC PR FRIGO ASTRA 220/230 50/60 SCH BLK



5

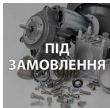

21001820

ACC PR MANTENITORE 100/240V 50-60HZ BLK
ACC PR MANTENITORE 100/240V 50-60HZ BLK