

# Model Machine

MACSAE198

SAECO AULIKA TOP

MACSAE198.T.0001



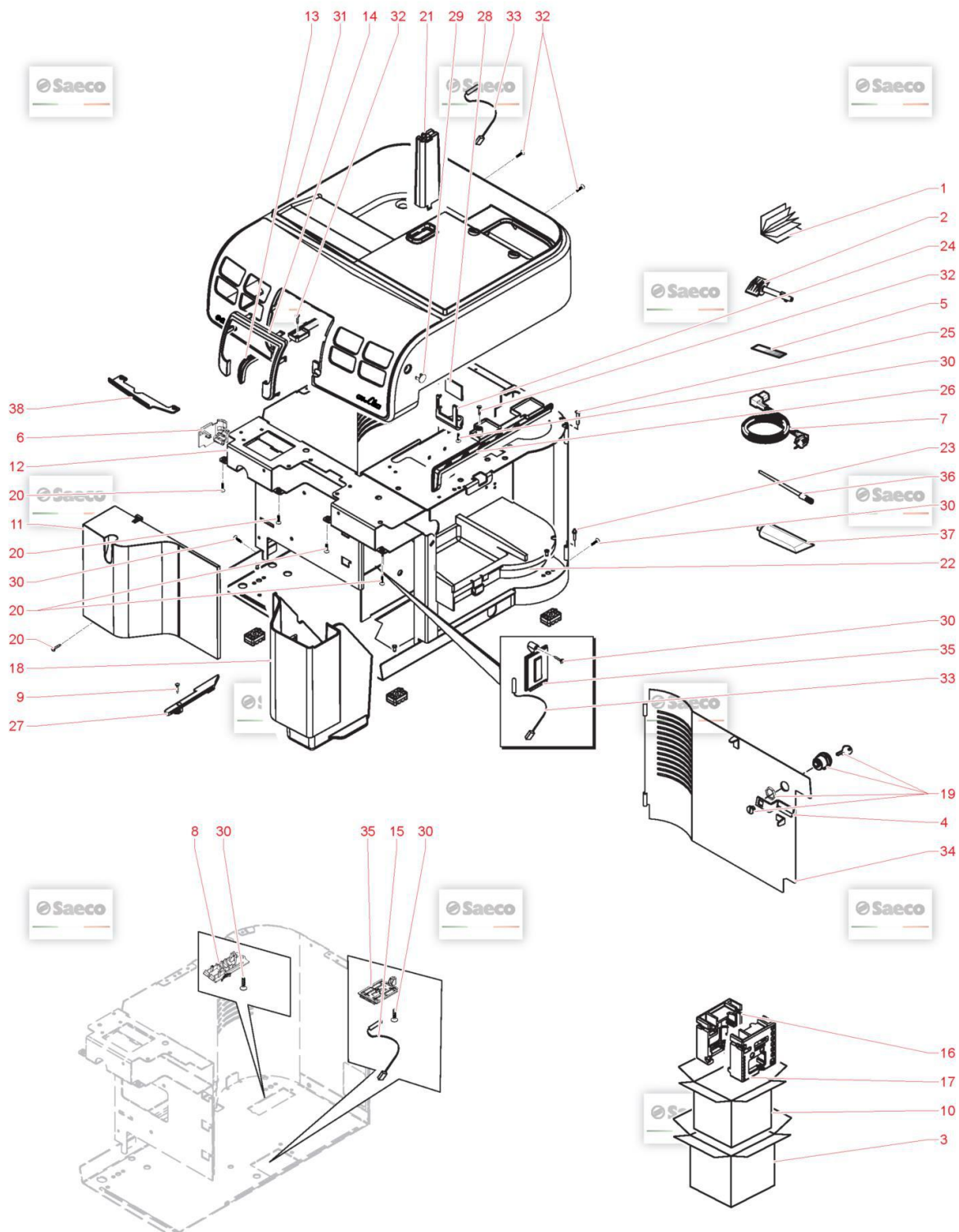









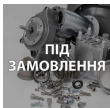

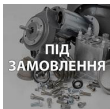

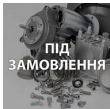

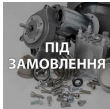

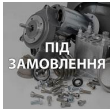

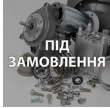

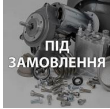
TAVOLA NR. 1 - ARTICOLO SAECO AULIKA TOP

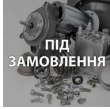

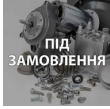
# Model Machine

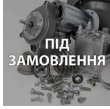
MACSAE198

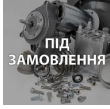

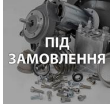







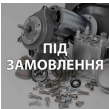





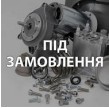



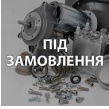



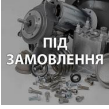

SAECO AULIKA TOP

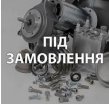
Web	Pos.	Foto	Item - Replace by	Description
				<i>Press - CTRL + CLICK go to item in a new window Натисніть - Ctrl + права кнопка миші щоб відкрити запчастину в новому вікні</i>
	1		15002812	MANUAL SAE SUP040R RYLO GB MANUAL SAE SUP040R RYLO GB
	1		15002813	MANUAL SAE SUP040R RYLO DE MANUAL SAE SUP040R RYLO DE
	1		15002814	MANUAL SAE SUP040R RYLO FR MANUAL SAE SUP040R RYLO FR
	1		15002815	MANUAL SAE SUP040R RYLO ES MANUAL SAE SUP040R RYLO ES
	1		15003775	MANUAL SAE SUP040R RYLO BRA MANUAL SAE SUP040R RYLO BRA
	1		15003906	MANUAL SAE SUP040R RYLO TWN MANUAL SAE SUP040R RYLO TWN
	1		15003907	MANUAL SAE SUP040R RYLO KOR MANUAL SAE SUP040R RYLO KOR
	1		15003908	MANUAL SAE SUP040R RYLO CHN MANUAL SAE SUP040R RYLO CHN
	1		15003922	MANUAL SAE SUP040R RYLO RI 17LANG. MANUAL SAE SUP040R RYLO RI 17LANG.
	1		421946027031	MANUAL WPM SUP040R RYLO/T CHN MANUAL WPM SUP040R RYLO/T CHN
	2		17000736	RED KEY FOR SAFETY MICRO RYLO RED KEY FOR SAFETY MICRO RYLO
	3		13001328	WHITE EXTERNAL BOX RYLO SAE WHITE EXTERNAL BOX RYLO SAE

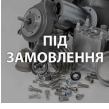
## Model Machine

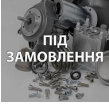
MACSAE198











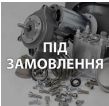

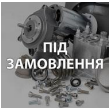













SAECO AULIKA TOP

	3		<b>421944052301</b>	WHT EXTERNAL BOX RYLO WPM <i>WHT EXTERNAL BOX RYLO WPM</i>
	4		<b>17001988</b>	STEEL CASING DOOR LOCK BRACKETRYLO <i>STEEL CASING DOOR LOCK BRACKET RYLO</i>
	5		<b>0301.961</b>	STICKER FOR WATER HARDNESS TEST <i>TEST DUREZZA ACQUA</i>
	6		<b>17000779</b>	BLACK STEAM TUBE PROTECTION RYL <i>BLACK STEAM TUBE PROTECTION RYL</i>
	7		<b>11001985</b>	BLACK POWER CABLE KOREA L=1200 <i>BLACK POWER CABLE KOREA L=1200</i>
	7		<b>11004246</b>	BLACK POWER CABLE TAIWAN HVCTFL=1200 <i>BLACK POWER CABLE TAIWAN HVCTF L=1200</i>
	7		<b>11004247</b>	BLACK POWER CABLE RVV 3X1 CHINA L=1200 <i>BLACK POWER CABLE RVV 3X1 CHINA L=1200</i>
	7		<b>17800019</b>	BLACK POWER CABLE BRAZIL L=1200 <i>BLACK POWER CABLE BRAZIL L=1200</i>
	7		<b>183911050</b>	ЧОРНИЙ КАБЕЛЬ SCHUKO L=1200 SAECO <i>BLACK POWER CABLE SCHUKO L=1200</i>
	7		<b>183940650</b>	BLACK POWER CABLE AUSTRALIA L=1200 <i>BLACK POWER CABLE AUSTRALIA L=1200</i>
	7		<b>NE01.093</b>	CABLE ARGENTINA + PLUG EN60320C13 <i>CABLE ARGENTINA + PLUG EN60320 C13</i>
	8		<b>17000828</b>	BLACK CASING BOTTOM PLUG RYLO <i>BLACK CASING BOTTOM PLUG RYLO</i>
	9		<b>12000895</b>	SCREW TSP TORX 10 3X10 PLAST.SS <i>SCREW TSP TORX 10 3X10 PLAST.SS</i>
	10		<b>13001327</b>	HAVANA BOX RYLO SAE AULIKA <i>HAVANA BOX RYLO SAE AULIKA</i>

## Model Machine

MACSAE198















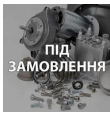



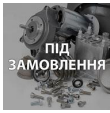



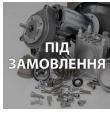

SAECO AULIKA TOP

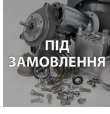
	11		<b>11030098</b>	CRC FRONT CASING COVER RYL/T <i>CRC FRONT CASING COVER RYL/T</i>
	11		<b>421944011851</b>	TXO/BLK FRONT CASING COVER RYL/T <i>TXO/BLK FRONT CASING COVER RYL/T</i>
	12		<b>11025857</b>	BLACK STEEL CASING RYLO/T ASSY. <i>BLACK STEEL CASING RYLO/T ASSY.</i>
	13		<b>17002048</b>	GREY CASING LEFT CLOSING INSERT RYLO/T <i>GREY CASING LEFT CLOSING INSERT V2 RYL</i>
	13		<b>421941301161</b>	BLK CASING LEFT CLOSING INSERTRYLO/T <i>BLK CASING LEFT CLOSING INSERTRYLO/T</i>
	14		<b>11030103</b>	CRC FRONT PANEL RYLO <i>CRC FRONT PANEL RYLO</i>
	15		<b>421946004691</b>	3P.CONN.DUMP BOX REED SENS.V2RYLO UL AS <i>3P.CONN.DUMP BOX REED SENS.V2 RYLO UL AS</i>
	16		<b>13001518</b>	PS-E LEFT INSERT FOR BOX RYLO <i>PS-E LEFT INSERT FOR BOX RYLO</i>
	17		<b>13001517</b>	PS-E RIGHT INSERT FOR BOX RYLO <i>PS-E RIGHT INSERT FOR BOX RYLO</i>
	18		<b>11029624</b>	CRC DUMP BOX RYLO ASSY. <i>CRC DUMP BOX RYLO ASSY.</i>
	18		<b>421944010831</b>	TXO/BLK DUMP BOX RYLO ASSY. <i>TXO/BLK DUMP BOX RYLO ASSY.</i>
	19		<b>12001902</b>	LOCK MERONI 337 <i>LOCK MERONI 337</i>
	20		<b>129535721</b>	SCREW TSP TORX 10 AB 3,5X9,5 SHEET SS <i>SCREW TSP TORX 10 AB 3,5X9,5 SHEET SS</i>
	21		<b>17000829</b>	BLACK BEAN CONTAINER SENSOR SUPPORT RYLO <i>BLACK BEAN CONTAINER SENSOR SUPPORT RYLO</i>

## Model Machine

MACSAE198

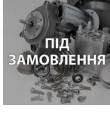











SAECO AULIKA TOP

	22		0301.041.150	GREY BREW UNIT SUPPORT PLATE ROYAL <i>PIASTRA SUPPORTO GRUPPO GRIGIO</i>
	23		0301.020	NIK/BRASS PIN FOR DOOR SUPERAUT. <i>NIK/BRASS PIN FOR DOOR SUPERAUT.</i>
	24		17001444	BLACK WATER LEVEL SENSOR SUPPORT RYLO <i>BLACK WATER LEVEL SENSOR SUPPORT RYLO</i>
	25		0301.019	NIK/BRASS PIN FOR DOOR SUPERAUT. <i>NIK/BRASS PIN FOR DOOR SUPERAUT.</i>
	26		11031307	BLACK CASING RIGHT CLOSING INSERT RYL <i>BLACK CASING RIGHT CLOSING INSERT RYL</i>
	26		17001369	GREY CASING RIGHT CLOSING INSERT V2 RYL <i>GREY CASING RIGHT CLOSING INSERT V2 RYL</i>
	27		17000723	GREY DUMP BOX GUIDE RYL <i>GREY DUMP BOX GUIDE RYL</i>
	28		421941306721	ПЛАТА-СЕНСОП РІВНЯ ВОДИ V3 A <i>CPU+SW WATER LEVEL SENSOR V3 ASSY.</i>
	29		17000422	TRANSP.INFRAREDS PLATE RYL <i>TRANSP.INFRAREDS PLATE RYL</i>
	30		12000450	SCREW TCB TORX 10 3,5X12 PLAST.ZN-N <i>SCREW TCB TORX 10 3,5X12 PLAST.ZN-N</i>
	31		20007081	SPARES KIT CRC CASING COVER S/SCR.RYLO <i>SPARES KIT CRC CASING COVER S/SCR.RYLO</i>
	31		421940813041	KIT SPARES TXO/BLK CASING COV.S/S.RYLO/T <i>KIT SPARES TXO/BLK CASING COV.S/S.RYLO/T</i>
	32		12001622	SCREW TCB TORX B 3,5X9,5 SCHEET NIK <i>SCREW TCB TORX B 3,5X9,5 SCHEET NIK</i>

## Model Machine

MACSAE198

SAECO AULIKA TOP

	33		17800442	2POLES CONNECT.SENSOR REED DUMP BOX CST <i>2POLES CONNECT.SENSOR REED DUMP BOX CST</i>
	34		11025819	BLACK CASING DOOR RYL ASSY. <i>BLACK CASING DOOR RYL ASSY.</i>
	35		17000240	GREY MOUNTING PLATE INSERT RYL <i>GREY MOUNTING PLATE INSERT RYL</i>
	37		11028379	PSA KLUBER TRIBOSTAR SIL TUBE5GR. <i>PSA KLUBER TRIBOSTAR SIL 2 TUBE 5GR.</i>
	37		421946017941	KLUBERLUB NH1 11-222 TUBE 5GR. <i>PSA KLUBER TRIBOSTAR SIL 2 TUBE 5GR.</i>
	38		421941305141	CRC CAPP.TUBE FRONT.SUPPORT RYLO/T <i>CRC CAPP.TUBE FRONT.SUPPORT RYLO/T</i>

# Model Machine

MACSAE198

SAECO AULIKA TOP

MACSAE198.T.0002

TAVOLA NR. 2 - ARTICOLO SAECO AULIKA TOP

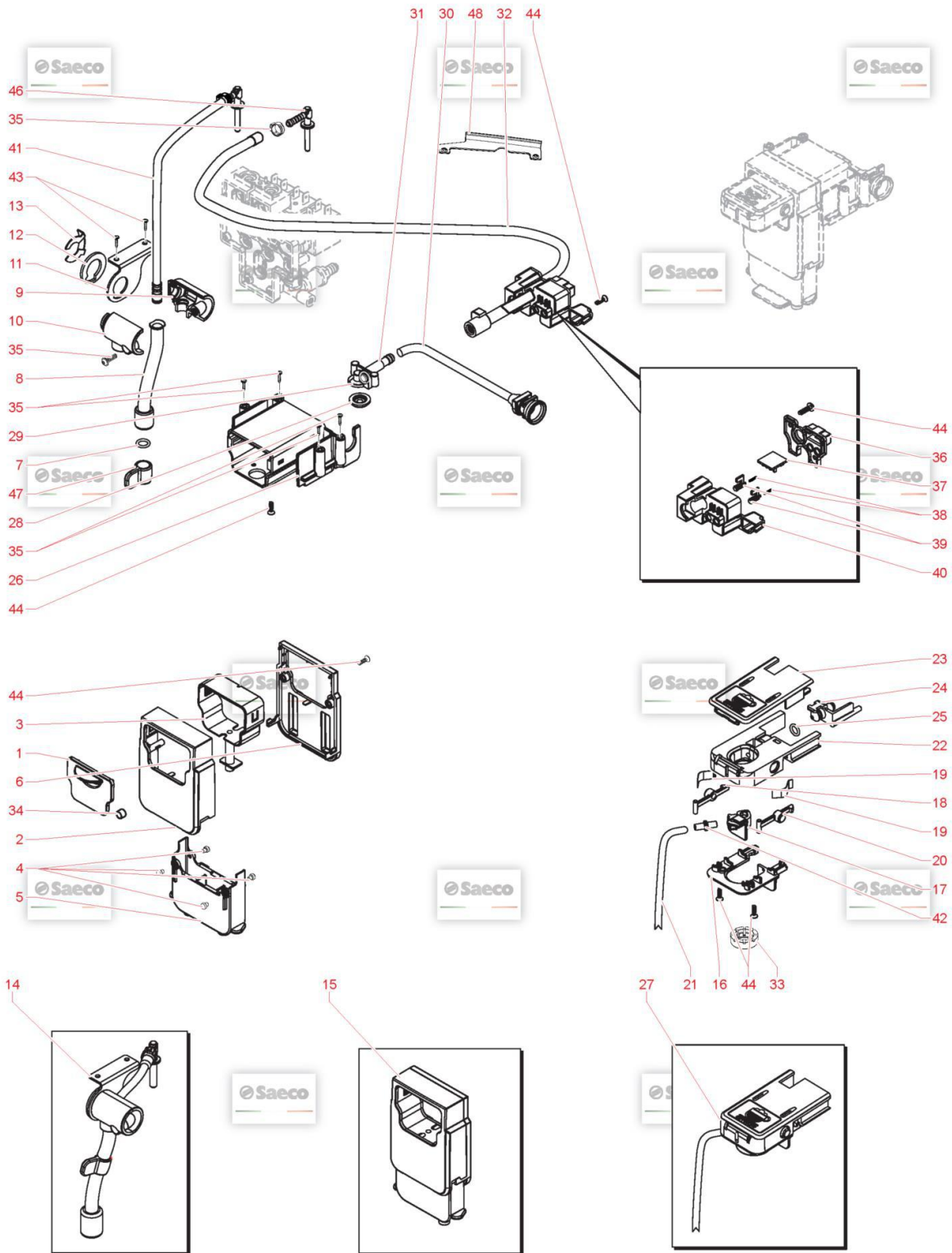

## Model Machine

MACSAE198

SAECO AULIKA TOP

Web Pos. Foto Item - Replace by Description



Press - CTRL + CLICK go to item in a new window

Натисніть - Ctrl + права кнопка миші щоб відкрити запчастину в новому вікні













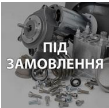













	1		<b>11030104</b>	CRC FRONT COF.DISP.COVER RYL/TASSY. CRC FRONT COF.DISP.COVER RYL/T ASSY.
	2		<b>11025756</b>	GLOSS/SPEC.FRONT COF.DISPENSERCOVER RYL GLOSS/SPEC.FRONT COF.DISPENSER COVER RYL
	3		<b>17000251</b>	BLACK INNER BODY COFFEE DISPENS.RYL BLACK INNER BODY COFFEE DISPENS.RYL
	4		<b>11013085</b>	WHITE COFFEE DISPENSER SLIDERMYB9 WHITE COFFEE DISPENSER SLIDER MYB9
	5		<b>17000246</b>	ЧОРНА ЗАГЛУШКА ЧАСТИНИ КАВОВОГО ДІСПЕНСОРА BLACK EXT.MOBILE PART COF.DISPENSER RYL
	6		<b>17000248</b>	BLACK REAR COVER COFFEE DISPENSER RYL BLACK REAR COVER COFFEE DISPENSER RYL
	7		<b>140321961</b>	ПРОКЛАДКА O-RING ДЛЯ КАВОМАШИНИ SAECO 2031 TERMOIL OR 2031 IN TERMOIL
	8		<b>11029670</b>	TF/CHROM.STEAM TUBE RYLO TF/CHROM.STEAM TUBE RYLO
	9		<b>17000672</b>	BLACK REAR STEAM TUBE SUPPORTRYL BLACK REAR STEAM TUBE SUPPORT RYL
	10		<b>17001437</b>	BLACK FRONT STEAM TUBE SUPPORTRYL BLACK FRONT STEAM TUBE SUPPORT RYL
	11		<b>17000815</b>	STEEL STEAM TUBE SUPPORT BRACKET RYL STEEL STEAM TUBE SUPPORT PLATE RYL
	12		<b>11001624</b>	BLACK STEAM TUBE WASHER P0049 BLACK STEAM TUBE WASHER P0049
	13		<b>NF11.084</b>	PHOSPH/STEEL FOLK SPRING PHOSPH/STEEL FOLK SPRING



## Model Machine

MACSAE198























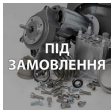

SAECO AULIKA TOP

	14		11031415	TF/CHR.TEA/BRASS STEAM TUBE V2RYLO ASSY TF/CHR.TEA/BRASS STEAM TUBE V2 RYLO ASSY
	15		11030101	CRC COFFEE DISPENSER RYL ASSY. AS.EROG.CAF.RYL CRC
	16		17000390	НИЖНЯ СТІНКА КАПУЧІНАТОРА SAECO BLACK LOWER CAPPUCINATORE LID RYL
	17		17000336	MILK INTAKE TUBE CONNECTOR RYL MILK INTAKE TUBE CONNECTOR RYL
	18		17000389	ЛІВА ЗАЦІПКА КАПУЧІНАТОРА GREY LEFT CAPPUCINATORE INSERT RYL
	19		17000382	SS CAPPUCINATORE INSERT SPRING RYL SS CAPPUCINATORE INSERT SPRING RYL
	20		17000402	GREY RIGHT CAPPUCINATORE INSERT RYL GREY RIGHT CAPPUCINATORE INSERT RYL
	21		11029672	SILICONE TUBE 3,5X6 L=500 MM SILICONE TUBE 3,5X6 L=500 MM
	22		17000338	BLACK LEFT ENTRY CAPPUCINAT.CASING RYL BLACK LEFT ENTRY CAPPUCINAT.CASING RYL
	23		11030240	BLK UPPER CAPPUC.LID LASER-S/SCR.RYL BLK UPPER CAPPUC.LID LASER-S/SCR.RYL
	24		17000785	BLACK CAPPUC.INPUT MILK CONNECTOR RYL BLACK CAPPUCINATORE MILK CONNECTOR RYL
	25		NM01.028	O-RING 106 SILICONE OR 106 SILICONE
	26		17000257	BLACK.COFFEE DISPENSER SUPPORTRYL BLACK.COFFEE DISPENSER SUPPORT RYL
	27		11029671	BLACK CAPPUCINATORE S/SCR.O ASSY. AS.CAPPUC.RYLO NER.SER.

## Model Machine

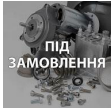
MACSAE198

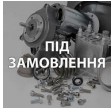













SAECO AULIKA TOP

	28		17000337	BLACK SEAL FOR COFFEE DISPENSER RYL <i>BLACK SEAL FOR COFFEE DISPENSER RYL</i>
	29		17000616	BLACK COFFEE DISPENSER TUBE RYL <i>BLACK COFFEE DISPENSER TUBE RYL</i>
	30		17000614	BLACK DISPENSER COFF.INLET CONNECT.RYL <i>BLACK DISPENSER COFF.INLET CONNECT.RYL</i>
	31		11014016	SS.INSERT FOR MAGNET MYB9 <i>SS.INSERT FOR MAGNET MYB9</i>
	32		20007031	BLK CAPPUC.OUTPUT STEAM CONNECT.KIT RYL <i>BLK CAPPUC.OUTPUT STEAM CONNECT.KIT RYL</i>
	33		17000486	BLK CAPPUCCIN.OUTPUT MILK CONNECTOR RYL <i>BLK CAPPUCCIN.OUTPUT MILK CONNECTOR RYL</i>
	34		9161.111	MAGNET FOR FLOAT SUPERAUT. <i>MAGNET FOR FLOAT SUPERAUT.</i>
	35		12000450	SCREW TCBR TORX 10 3,5X12 PLAST.ZN-N <i>SCREW TCBR TORX 10 3,5X12 PLAST.ZN-N</i>
	36	 ПІД ЗАМОВЛЕННЯ	17000348	BLK CAPPUCCINATORE BOARD SUPP.COVER RYL <i>BLK CAPPUCCINATORE BOARD SUPP.COVER RYL</i>
	37		11025772	CAPPUCCINATORE BOARD RYL <i>CAPPUCCINATORE BOARD RYL</i>
	38	 ПІД ЗАМОВЛЕННЯ	17000019	SS CARAFE MICRO INSERT SPRINGMYB9 <i>SS CARAFE MICRO INSERT SPRING MYB9</i>
	39	 ПІД ЗАМОВЛЕННЯ	17000421	BLACK CAPPUCCINATORE PRESENCEINSERT RYL <i>BLACK CAPPUCCINATORE PRESENCE INSERT RYL</i>
	40	 ПІД ЗАМОВЛЕННЯ	17000339	BLACK CAPPUCCINATORE BOARD SUPPORT RYL <i>BLACK CAPPUCCINATORE BOARD SUPPORT RYL</i>

## Model Machine

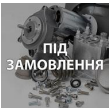
MACSAE198

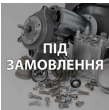
SAECO AULIKA TOP

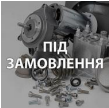
	41		20007030	BLACK OUTPUT STEAM TUBE KIT RYL <i>BLACK OUTPUT STEAM TUBE KIT RYL</i>
	42		17001362	BLK MILK INTAKE TUBE CONNECT.INS.V2 RYL <i>BLK MILK INTAKE TUBE CONNECT.INS.V2 RYL</i>
	43		12001622	SCREW TCB TORX B 3,5X9,5 SCHEET NIK <i>SCREW TCB TORX B 3,5X9,5 SCHEET NIK</i>
	44		12000895	SCREW TSP TORX 10 3X10 PLAST.SS <i>SCREW TSP TORX 10 3X10 PLAST.SS</i>
	45		NF11.052	OETIKER CLIP <i>OETIKER CLIP</i>
	46		11031165	TEA/BRASS CAPPUC/STEAM TUBE CONN.V3 RYL <i>TEA/BRASS CAPPUC/STEAM TUBE CONN.V3 RYL</i>
	47		17001574	BLACK STEAM TUBE HANDGRIP RYLO <i>BLACK STEAM TUBE HANDGRIP RYLO</i>
	48		421941305141	CRC CAPP.TUBE FRONT.SUPPORT RYLO/T <i>CRC CAPP.TUBE FRONT.SUPPORT RYLO/T</i>

# Model Machine

MACSAE198

SAECO AULIKA TOP

MACSAE198.T.0003

TAVOLA NR. 3 - ARTICOLO SAECO AULIKA TOP

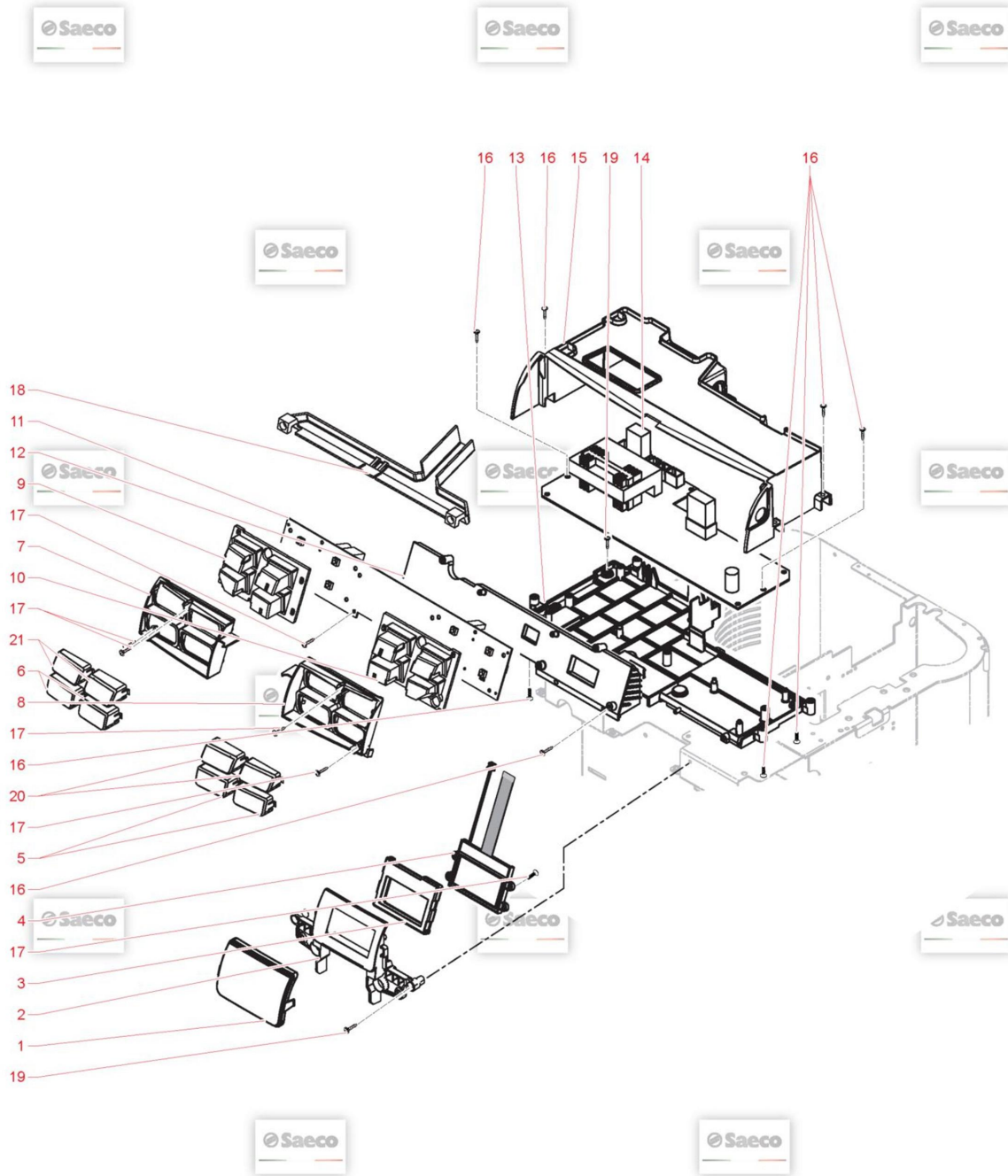

## Model Machine

MACSAE198

SAECO AULIKA TOP

Web Pos. Foto Item - Replace by Description



Press - CTRL + CLICK go to item in a new window  
Натисніть - Ctrl + права кнопка миші щоб відкрити запчастину в новому вікні



1



17000269

СКЛО ДИСПЛЕЯ PHILIPS SAECO 996530068575  
TRANSP.GLASS FOR DISPLAY RYL



2



17000259

BLACK DISPLAY INSERT RYL  
BLACK DISPLAY INSERT RYL



3



17000271

BLACK DISPLAY SEAL RYL  
BLACK DISPLAY SEAL RYL



4



12001779

WHITE DISPLAY 160X80  
WHITE DISPLAY 160X80 0355DP RYL



5

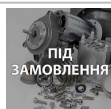

11030168

CRC RIGHT LOW.T.PANEL COVER S/SC.RYLO/T  
COP.TASTIERA INF.DX RYLO CRC+TRA.SER.



5

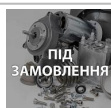

421944011051

TXOBLK RIGHT LOW.T.PAN.COVER S/SC.RYLO/T  
TXOBLK RIGHT LOW.T.PAN.COVER S/SC.RYLO/T



6



11030169

CRC LEFT LOW.T.PANEL COVER S/SC.RYLO/T  
COP.TASTIERA INF.SX RYLO CRC+TRA.SER.



6

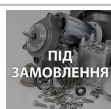

421944011061

TXOBLK LEFT LOW.T.PAN.COVER S/SC.RYLO/T  
TXOBLK LEFT LOW.T.PAN.COVER S/SC.RYLO/T



7

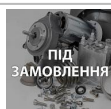

17000831

BLACK LEFT TOUCH PANEL SUPPORT RYLO  
BLACK LEFT TOUCH PANEL SUPPORT RYLO



8

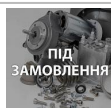

17000830

BLACK RIGHT TOUCH PANEL SUPPORT RYLO  
BLACK RIGHT TOUCH PANEL SUPPORT RYLO



9



17000485

TRANSP.LEFT TOUCH PANEL RYLO  
TRANSP.LEFT TOUCH PANEL RYLO



10

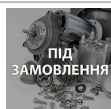

17000484

TRANSP.RIGHT TOUCH PANEL RYLO  
TRANSP.RIGHT TOUCH PANEL RYLO



11













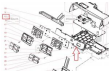

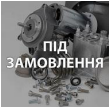



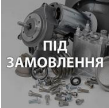







11027084

CPU+SW RYLO ASSY.  
CPU+SW RYLO ASSY. AULIKA TOP

## Model Machine

MACSAE198

SAECO AULIKA TOP



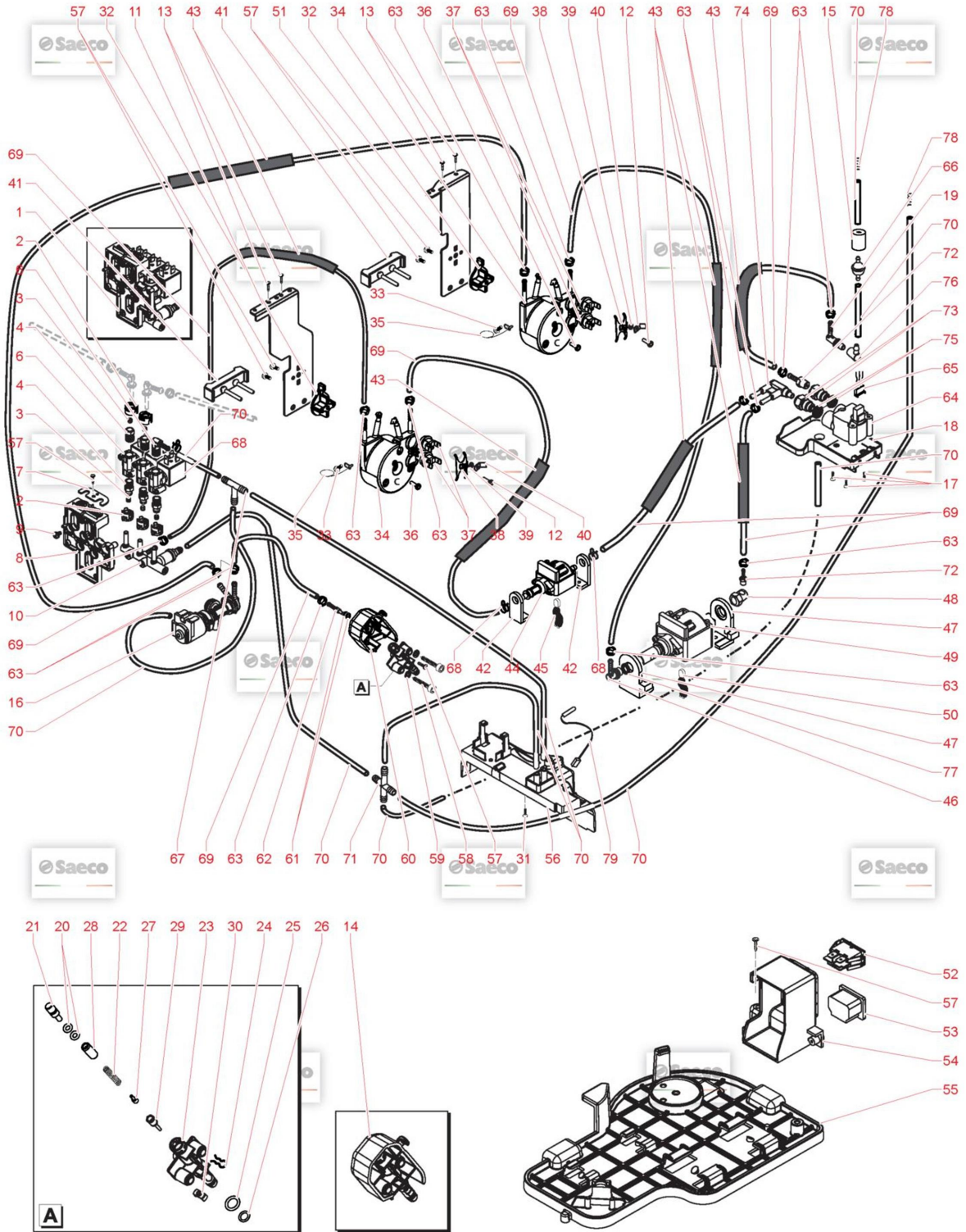























	12		<b>17000274</b>	BLACK CPU BOARD SUPPORT RYL <i>BLACK CPU BOARD SUPPORT RYL</i>
	13		<b>17000275</b>	BLACK PWR BOARD SUPPORT RYL <i>BLACK PWR BOARD SUPPORT RYL</i>
	14		<b>11030311</b>	PWR BOARD RYLO 230V <i>PWR BOARD RYLO 230V</i>
	14		<b>421941302411</b>	PWR BOARD RYLO 120V <i>PWR BOARD RYLO 120V</i>
	15		<b>17000277</b>	BLACK CPU-PWR BOARDS COVER RYL <i>BLACK CPU-PWR BOARDS COVER RYL</i>
	16		<b>12000450</b>	SCREW TCB TORX 10 3,5X12 PLAST.ZN-N <i>SCREW TCB TORX 10 3,5X12 PLAST.ZN-N</i>
	17		<b>129913202</b>	SCREW TCB TORX 10 3X8 PLAST.ZN-B <i>SCREW TCB TORX 10 3X8 PLAST.ZN-B</i>
	18		<b>17001152</b>	POWER BOARD PROTECTION RYL <i>POWER BOARD PROTECTION RYL</i>
	19		<b>12001622</b>	SCREW TCB TORX B 3,5X9,5 SCHEET NIK <i>SCREW TCB TORX B 3,5X9,5 SCHEET NIK</i>
	20		<b>11025849</b>	CRC RIGHT UPP.T.PANEL COVER S/SC.RYLO/T <i>CRC RIGHT UPPER T.PANEL COVER S/SCR.RYLO</i>
	20		<b>421944011021</b>	TXOBLK RIGHT UPP.T.PAN.COVER S/SC.RYLO/T <i>TXOBLK RIGHT UPP.T.PAN.COVER S/SC.RYLO/T</i>
	21		<b>11025850</b>	CRC LEFT UPP.T.PANEL COVER S/SC.RYLO/T <i>CRC LEFT UPPER T.PANEL COVER S/SCR.RYLO</i>
	21		<b>421944011041</b>	TXOBLK LEFT UPP.T.PAN.COVER S/SC.RYLO/T <i>TXOBLK LEFT UPP.T.PAN.COVER S/SC.RYLO/T</i>

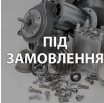

## Model Machine

MACSAE198

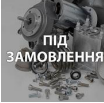
SAECO AULIKA TOP

















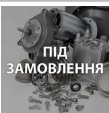

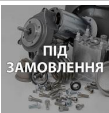

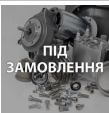

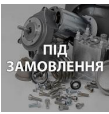



Web	Pos.	Foto	Item - Replace by	Description
				<i>Press - CTRL + CLICK go to item in a new window Натисніть - Ctrl + права кнопка миші щоб відкрити запчастину в новому вікні</i>
	1		11031414	TEA/BRASS ELECTROV.V3 24V RYL/T ASSY. PHILIPS SAECO 996530073228 TEA/BRASS ELECTROV.V3 24V RYL/T ASSY.
	2		17001178	BLK EV 1/8"GAS.CONNECTOR V2 INSERT RYL BLK EV 1/8 GAS.CONNECTOR V2 INSERT RYL
	3		17001909	RED EV CONNECTOR 1/8"GAS SEALV2 RYL RED EV CONNECTOR 1/8 GAS SEAL V2 RYL
	4		11027334	3'ЄДНАННЯ 1/8"GAS V2 RYL TEA/BRASS ELECTROV.CONNECT1/8"GAS V2 RYL
	5		17001262	LFBASS 2W.EV 21JN1R4V20-X031 LFBASS 2W.EV 21JN1RRV20-X005+LBV05024CU
	6		11024469	L-F/BRASS CONNECTOR FOR BOILERAURA L-F/BRASS CONNECTOR FOR BOILER AURA
	7		17000428	STEEL CONNECTORS FIXING PLATERYL STEEL CONNECTORS FIXING PLATE RYL
	8		17000168	BLACK ELECTROV/CONNECTOR SUPP.RYL BLACK ELECTROV/CONNECTOR SUPP.RYL
	9		U043.012	SCREW TCB TORX 20 M4X6 ZN-B VITE TCBC M4,0X6 UNI 7687 Z
	10		17001908	BRASS 4WAYS CONNECT+SAFETY VALVE V3 RYL BRASS 4WAYS CONNECT+SAFETY VALVE V3 RYL
	11		17000166	STEEL STEAM TUBOL.BOILER SUPPORT RYL STEEL STEAM TUBOL.BOILER SUPPORT RYL
	12		12001715	SCREW TCB TORX 20 M4X8 AUTOFORMING ZN-B SCREW TCB TORX 20 M4X8 AUTOFORMING ZN-B
	13		12001622	SCREW TCB TORX B 3,5X9,5 SCHEET NIK SCREW TCB TORX B 3,5X9,5 SCHEET NIK



## Model Machine

MACSAE198























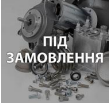

SAECO AULIKA TOP

	14		<b>11025744</b>	TEA/BRASS HOT WATER PIN RYL ASSY. <i>TEA/BRASS HOT WATER PIN RYL ASSY.</i>
	15		<b>147756562</b>	BLK PROTECTION FOR FOLK SPRINGTUBE D=4 <i>BLK PROTECTION FOR FOLK SPRING TUBE D=4</i>
	16		<b>11025742</b>	BLOWDOWN VALVE V3 RYL 230V ASSY. <i>BLOWDOWN VALVE V3 RYL 230V ASSY.</i>
	16	 ПІД ЗАМОВЛЕННЯ	<b>11028161</b>	BLOWDOWN VALVE V3 RYL 220V-60HZ ASSY. <i>BLOWDOWN VALVE V3 RYL 220V-60HZ ASSY.</i>
	16	 ПІД ЗАМОВЛЕННЯ	<b>11028187</b>	BLOWDOWN VALVE V3 RYL 120V ASSY. <i>BLOWDOWN VALVE V3 RYL 120V ASSY.</i>
	17	 ПІД ЗАМОВЛЕННЯ	<b>129912104</b>	SCREW TCBR TORX 20 4X10 PLAST.ZN-N <i>SCREW TCBR TORX 20 4X10 PLAST.ZN-N</i>
	18	 ПІД ЗАМОВЛЕННЯ	<b>17000821</b>	BLACK TURBINE SUPPORT RYLO <i>BLACK TURBINE SUPPORT RYLO</i>
	19		<b>17001358</b>	BLK WATER CONT/FLOWMETER 90°CONNECT.RYLO <i>BLK WATER CONT/FLOWMETER 90°CONNECT.RYLO</i>
	20		<b>140326662</b>	OR ORM 0040-20 SILICONE <i>OR METRIC 0040-20 IN SILICONE</i>
	21		<b>11026413</b>	TEA/BRASS HOT WATER PIN PLUG RYL <i>TEA/BRASS HOT WATER PIN PLUG RYL</i>
	22		<b>9011.132</b>	SS SPRING FOR PIN <i>MOLLA X SPILLO</i>
	23		<b>9161.434</b>	HOT WATER PIN <i>PERNO CALDAIA MAGIC,ROYAL SAECO</i>
	24		<b>9011.144</b>	SS FORK FOR TUBE D=4 <i>FORCELLA X TUBO D.4</i>
	25		<b>NM01.035</b>	OR ORM 0090-20 SILICONE <i>OR ORM 0090-20 SILICONE</i>

## Model Machine

MACSAE198











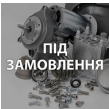





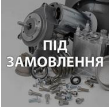

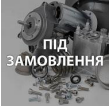

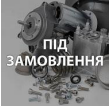



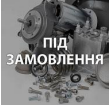

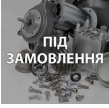
SAECO AULIKA TOP

	26		NM01.057	OR ORM 0050-20 IN SILICONE <i>OR ORM 0050-20 IN SILICONE</i>
	27		11009013	TEA/BRASS PIN FOR PISTON L=10 <i>TEA/BRASS PIN FOR PISTON L=10</i>
	28		11009012	TEA/BRASS BOILER PIN BUSH <i>TEA/BRASS BOILER PIN BUSH</i>
	29		11009019	TEA/BRASS PISTON L=20,9 ASSY. <i>TEA/BRASS PISTON L=20,9 ASSY.</i>
	30		11005099	NATURAL CURSOR V2 FOR BOILER P119 <i>NATURAL CURSOR V2 FOR BOILER P119</i>
	31		129913902	SCREW TCB TORX 10 3X12 PLAST.ZN-B <i>SCREW TCB TORX 10 3X12 PLAST.ZN-B</i>
	32		11023282	BLACK SLIM TUB.BOILERS SUPPORTMYB9 <i>BLACK SLIM TUB.BOILERS SUPPORT MYB9</i>
	33		129573402	SCREW TAPT M4X10 DIN 7985 GALV <i>SCREW TAPT M4X10 DIN 7985 GALV</i>
	34		11013735	SLIM TUB.BOILER 1300W 230V ASSY. <i>SLIM TUB.BOILER 1300W 230V ASSY. NUOVO PREZZO 13,3</i>
	34		11023153	SLIM TUB.BOILER 1300W 120V ASSY. <i>SLIM TUB.BOILER 1300W 120V ASSY.</i>
	35		190800100	ТЕМПЕРАТУРНИЙ СЕНСОП NTC UL L=280MM <i>TEMPERATURE SENSOR NTC UL L=280MM</i>
	36		12001369	SCREW TSP TORX 10 5X35 PLAST.SS <i>SCREW TSP TORX 10 5X35 PLAST.SS</i>
	37		12001033	ТЕРМОСТАТ 190°С БОЙЛЕРА ДЛЯ КОФЕВАРОК PHILIPS SAECO 12001033 <i>THERMOSTAT ONE SHOT 190°</i>

## Model Machine

MACSAE198

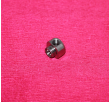









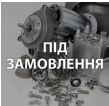

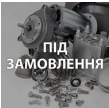













SAECO AULIKA TOP

	38		11001751	TUB.BOILER V3 UPPER THERM.FIXING SPRING <i>TUB.BOILER V3 UPPER THERM.FIXING SPRING</i>
	39		128310402	GALV.WASHER UNI 8842 A4 <i>GALV.WASHER UNI 8842 A4</i>
	40		124390520	BRASS BENT FASTON 45° 6,3X0,8 <i>BRASS BENT FASTON 45° 6,3X0,8</i>
	41		17000471	BLACK BOILER ANTIVIBRATION RYL <i>BLACK BOILER ANTIVIBRATION RYL</i>
	42		11029554	BLACK/SBD ULKA MF PUMP SUPPORT <i>BLACK/SBD ULKA MF PUMP SUPPORT</i>
	43		16000540	TRANSPAR.11X12,8 SILICONE TUBEIN ROLL <i>TRANSPAR.11X12,8 SILICONE TUBE IN ROLL</i>
	44		12001212	ULKA PUMP MF 230V-50HZ <i>ULKA PUMP MF 230V-50HZ</i>
	44		12001346	ULKA PUMP MF 120V-60HZ <i>POMPA ULKA MF 120V-60HZ</i>
	44		12001348	ULKA PUMP MF 220V-50/60HZ <i>ULKA PUMP MF 220V-50/60HZ</i>
	45		17800203	ДВОПОЛЮСОВИЙ ДАТЧИК ПЕРЕГРІВУ ПОМПИ ВЗБОРІ PHILIPS SAECO ... <i>2POLES CONNECTOR STEAM PUMP RYL UL</i>
	46		11001054	СОЕДИНИТЕЛЬНЫЙ УГОЛОК 90° К НАСОСУ P0049/B PHILIPS SAECO 996... <i>BLK PUMP OUTLET 90° CONNECTOR P0049/B</i>
	47		11022857	BLACK PUMP SUPPORT GMYB <i>BLACK PUMP SUPPORT GMYB</i>
	48		9181.350	TEA/BRASS REAR CONNECTOR 1/8"ULKA PUMP <i>TEA/BRASS REAR CONNECTOR 1/8 ULKA PUMP</i>
	49		12000131	ULKA PUMP EP5/S 120V-60HZ <i>ULKA PUMP EP5/S 120V-60HZ</i>

## Model Machine

MACSAE198













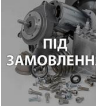







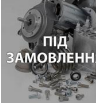



SAECO AULIKA TOP

	49		<b>12000140</b>	PUMP 230V-50HZ <i>ULKA PUMP EP5/S GW 230V-50HZ</i>
	49		<b>12000182</b>	ULKA PUMP EP5/S GW 220V-60HZ <i>ULKA PUMP EP5/S GW 220V-60HZ</i>
	49		<b>421941305991</b>	ULKA PUMP EP5FMGW 230V-50HZ <i>ULKA PUMP EP5FMGW 230V-50HZ</i>
	50		<b>17800202</b>	2POLES CONNECTOR COFFEE PUMP RYL UL <i>2POLES CONNECTOR COFFEE PUMP RYL UL</i>
	51		<b>17000163</b>	STEEL COFFEE TUBOL.BOILER SUPPORT RYL/T <i>STEEL COFFEE TUBOL.BOILER SUPPORT RYL</i>
	52		<b>NE03.038</b>	BIPOLAR SWITCH FUSIT C1250AR <i>BIPOLAR SWITCH FUSIT C1250AR</i>
	53		<b>12001883</b>	CUP SOCKET V3 EN 60320 C 13 <i>CUP SOCKET V3 EN 60320 C 13</i>
	54		<b>11028204</b>	BLACK SOCKET-SWITCH SUPPORT RYL UL <i>BLACK SOCKET-SWITCH SUPPORT RYL UL</i>
	54		<b>17000162</b>	BLACK SOCKET-SWITCH SUPPORT RYL <i>BLACK SOCKET-SWITCH SUPPORT RYL</i>
	55		<b>17000973</b>	BLACK COMPONENTS SUPPORT RYLO <i>BLACK COMPONENTS SUPPORT RYLO</i>
	56		<b>17000165</b>	BLACK DRIP TRAY PROTECTION RYL <i>BLACK DRIP TRAY PROTECTION RYL</i>
	57		<b>12000450</b>	SCREW TCBR TORX 10 3,5X12 PLAST.ZN-N <i>SCREW TCBR TORX 10 3,5X12 PLAST.ZN-N</i>
	58		<b>11003555</b>	GALVANIZED SELF-TAPPING SCREW4,8X32 <i>GALVANIZED SELF-TAPPING SCREW 4,8X32</i>
	59		<b>128310521</b>	WASHER UNI 8842 A5 SS <i>WASHER UNI 8842 A5 SS</i>

## Model Machine

MACSAE198

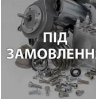









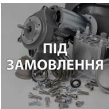







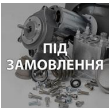

SAECO AULIKA TOP

	60		17000156	BLACK HOT WATER PIN SUPPORT RYL <i>BLACK HOT WATER PIN SUPPORT RYL</i>
	61		140328059	OR 2015 SILICONE PTFE/FDA <i>OR 2015 SILICONE PTFE/FDA</i>
	62		11000750	TEA/BRASS CONNECTOR FOR SILICONE TUBE <i>TEA/BRASS CONNECTOR FOR SILICONE TUBE</i>
	63		12000892	ЗАЖИМ D.9,5 16700004 <i>OETIKER CLAMP D=9,5 16700004 ( L250 )</i>
	64		NV99.033	ПЛАСТИКОВА ТУРБИНА ВИСОКОГО ТИСКУ <i>TURBINA DIGMESA IN PLASTICA</i>
	65		421946001561	6P.CONN.FLOWMETER V2 RYLO UL ASSY. <i>6P.CONN.FLOWMETER V2 RYLO UL ASSY.</i>
	66		12001595	TRANSP/WHITE ASPIRATION FILTERMDS <i>TRANSP/WHITE ASPIRATION FILTER MDS</i>
	67		147920300	TRANS.CONNECTOR D=8 ART.80.26.047 KA.461 <i>RACCORDO T D=8 ART.80.26.047 KA.461</i>
	68		184320200	SPRING HOSE CLAMP D=9,5MM <i>MOLLA STRINGITUBO D=9,5MM</i>
	69		16000380	5X8,9 SILICONE TUBE IN ROLL <i>5X8,9 SILICONE TUBE IN ROLL</i>
	70		JS01.022	SILICONE TUBE 5X10 60SH IN ROLL <i>SILICONE TUBE 5X10 60SH IN ROLL</i>
	71		12001812	TRANSP.CROSS CONNECTOR D=8 RYLO <i>TRANSP.CROSS CONNECTOR D=8 RYLO</i>
	72		11006304	TEA/BRASS CONNECTOR FOR ALUM.BOILER <i>TEA/BRASS CONNECTOR FOR ALUM.BOILER</i>

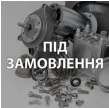
## Model Machine

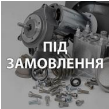
MACSAE198

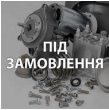
SAECO AULIKA TOP

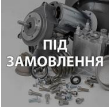
	73		9181.406	TEA/BRASS CONNECTOR TURBINE MF1/4 1/8 <i>TEA/BRASS CONNECTOR TURBINE MF 1/4 1/8</i>
	74		11010243	TEA/BRASS 90° DOUBLE CONNECTOR <i>TEA/BRASS 90° DOUBLE CONNECTOR</i>
	75		NM01.049	OR ORM 0070-20 SILICONE <i>OR ORM 0070-20 SILICONE</i>
	76		147920150	90° INLET PUMP CONNECTOR <i>RACCORDO A 90° IN SANTOPRENE</i>
	77		140321961	ПРОКЛАДКА O-RING ДЛЯ КАВОМАШИНИ SAECO 2031 TERMOIL <i>OR 2031 IN TERMOIL</i>
	78		0701.081	SPRING FOR TUBE PRODUCT 1 <i>SPRING FOR TUBE PRODUCT 1</i>
	79		17800442	2POLES CONNECT.SENSOR REED DUMP BOX CST <i>2POLES CONNECT.SENSOR REED DUMP BOX CST</i>
	10001		11025705	COFFEE TUB.BOILER 230V RYL/T ASSY. <i>COFFEE TUB.BOILER 230V RYL/T ASSY.</i>
	10001		11025706	STEAM TUB.BOILER 230V RYL ASSY. <i>STEAM TUB.BOILER 230V RYL ASSY.</i>
	10001		11028182	COFFEE TUB.BOILER 120V RYL/T ASSY. <i>COFFEE TUB.BOILER 120V RYL/T ASSY.</i>
	10001		11028183	STEAM TUB.BOILER 120V RYL ASSY. <i>STEAM TUB.BOILER 120V RYL ASSY.</i>

# Model Machine

MACSAE198

SAECO AULIKA TOP

MACSAE198.T.0005

TAVOLA NR. 5 - ARTICOLO SAECO AULIKA TOP

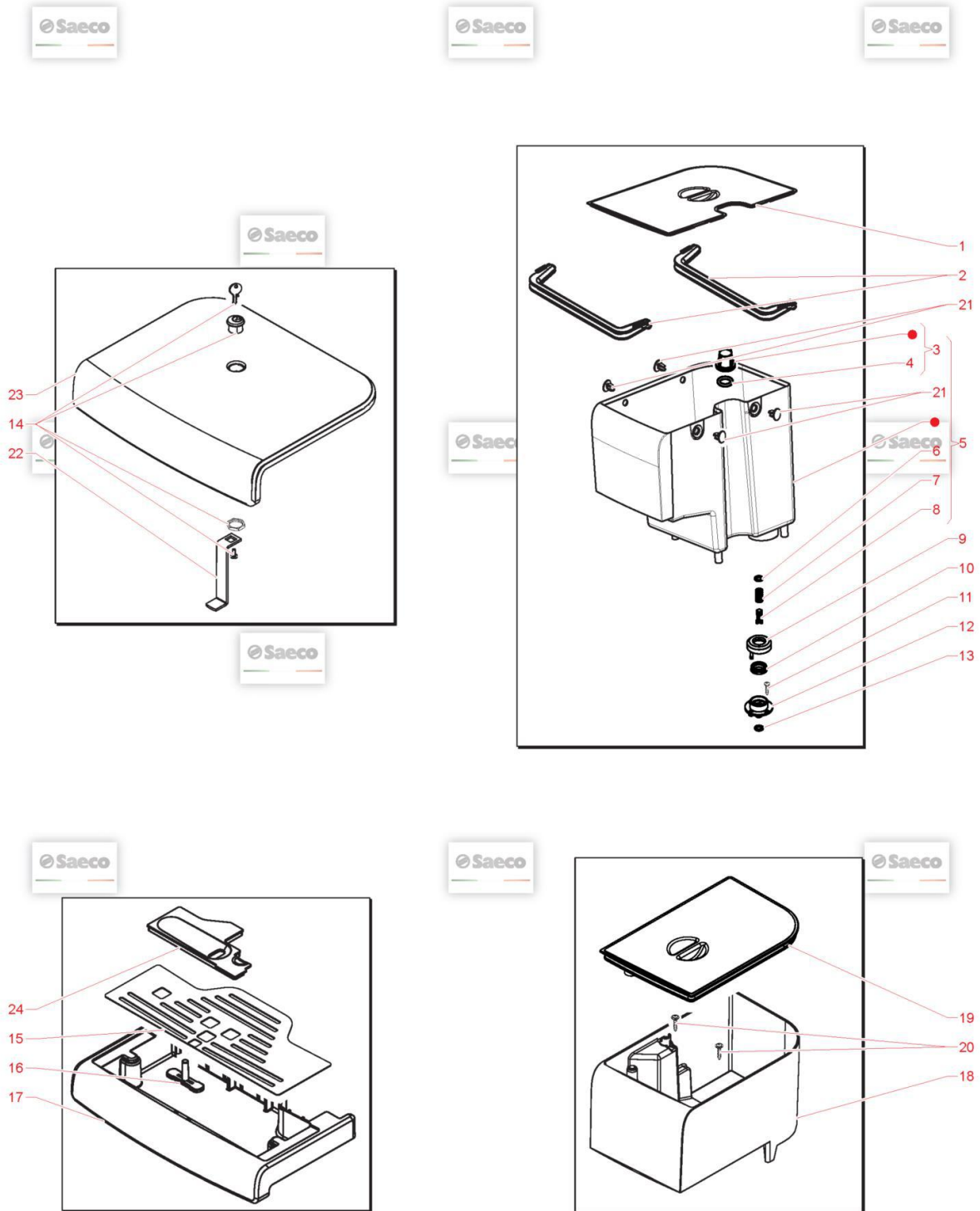



























## Model Machine

MACSAE198

SAECO AULIKA TOP

Web Pos. Foto Item - Replace by Description

 *Press - CTRL + CLICK go to item in a new window*  
*Натисніть - Ctrl + права кнопка миші щоб відкрити запчастину в новому вікні*













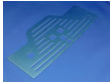











	1		11025848	BLACK WATER CONTAINER LID RYLO <i>COPERCHIO.CONTENTITORE.ACQUA.NERO LID RYLO</i>
	2		11025847	BLACK HANDLE WATER CONTAINER LID RYLO <i>BLACK HANDLE WATER CONTAINER LID RYLO</i>
	3		224640200	БІЛИЙ ПЛАСТИКОВИЙ ФІЛЬТР У КОНТЕЙНЕР ВОДИ SAECO 996530029115 <i>EXTERNAL FILTER FOR WATER CONTAINER ASSY</i>
	4		140328461	ПРОКЛАДКА O-RING 0190-10 ДЛЯ КОФЕМАШИНИ PHILIPS SAECO 99653... <i>OR METRICO 0190-10 IN EPDM NUOVO PREZZO 0,13</i>
	5		11025846	TRANSP/GREY WATER CONTAINER RYLO ASSY. <i>NAT/GREY WATER CONTAINER RYLO ASSY.</i>
	6		140324362	OR ORM 0060-30 SILICONE <i>OR METRIC 0060-30 IN SILICONE</i>
	7		126764718	SS WATER CONTAINER VALVE SPRING <i>SS WATER CONTAINER VALVE SPRING</i>
	8		147660562	GREY PISTON FOR WATER CONTAINER VALVE <i>GREY PISTON FOR WATER CONTAINER VALVE</i>
	9		0701.031.150	GREY WATER VALVE GACO DIM 14 SEAL COVER <i>SEAL COVER GREY</i>
	10		145842900	NBR WATER CONT.VALVE GACO DIM14 SEAL <i>NBR WATER CONT.VALVE GACO DIM14 SEAL</i>
	11		12000895	SCREW TSP TORX 10 3X10 PLAST.SS <i>SCREW TSP TORX 10 3X10 PLAST.SS</i>
	12		0701.014.150	GREY WATER VALVE GACO DIM 14 SEAL CONT. <i>GREY WATER VALVE GACO DIM 14 SEAL CONT.</i>
	13		140320461	OR ORM 0080-20 TERMOIL <i>OR ORM 0080-20 IN TERMOIL</i>

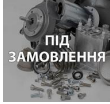

## Model Machine

MACSAE198

SAECO AULIKA TOP

	14		12001902	LOCK MERONI 337 <i>LOCK MERONI 337</i>
	15		11029899	SB/SS DRIP TRAY GRATE RYL/T <i>SB/SS DRIP TRAY GRATE RYL</i>
	16		17000991	RED FLOAT V2 FOR DRIP TRAY RYL <i>RED FLOAT V2 FOR DRIP TRAY RYL</i>
	17		11030099	CRC DRIP TRAY RYL ASSY. <i>AS.VASCA REC.ACQ.RYL VERN.CRC</i>
	17		11031093	TXO/BLK DRIP TRAY RYL ASSY. <i>AS.VASCA REC.ACQ.RYL VERN.NER/TXO</i>
	18		11025841	TRANSP/GREY BEAN CONTAINER RYLO <i>NAT/GREY BEAN CONTAINER RYLO</i>
	19		11025844	BLACK BEAN COFFEE CONTAIN.LID RYLO ASSY. <i>BLACK BEAN COFFEE CONTAIN.LID RYLO ASSY.</i>
	20		12001431	SCREW TCB TORX 10 3X12 PLAST.SS <i>SCREW TCB TORX 10 3X12 PLAST.SS</i>
	21		17001255	ЗАТИЧКА 1 ШТ <i>BLACK PLUG FOR WATER CONTAIN.HANDLE RYL</i>
	22		17001987	STEEL CONTAINERS LID LOCK BRACKET RYLO <i>STEEL CONTAINERS LID LOCK BRACKET RYLO</i>
	23		11025829	CRC CONTAINERS LID RYLO TO ASSY. <i>CRC CONTAINERS LID RYLO TO ASSY.</i>
	23		421941301061	TXO/BLK CONTAINERS LID RYLO TO ASSY. <i>TXO/BLK CONTAINERS LID RYLO TO ASSY.</i>
	24		17000982	BLACK DRIP TRAY COVER RYL <i>BLACK DRIP TRAY COVER RYL</i>

# Model Machine

MACSAE198

SAECO AULIKA TOP

MACSAE198.T.0006



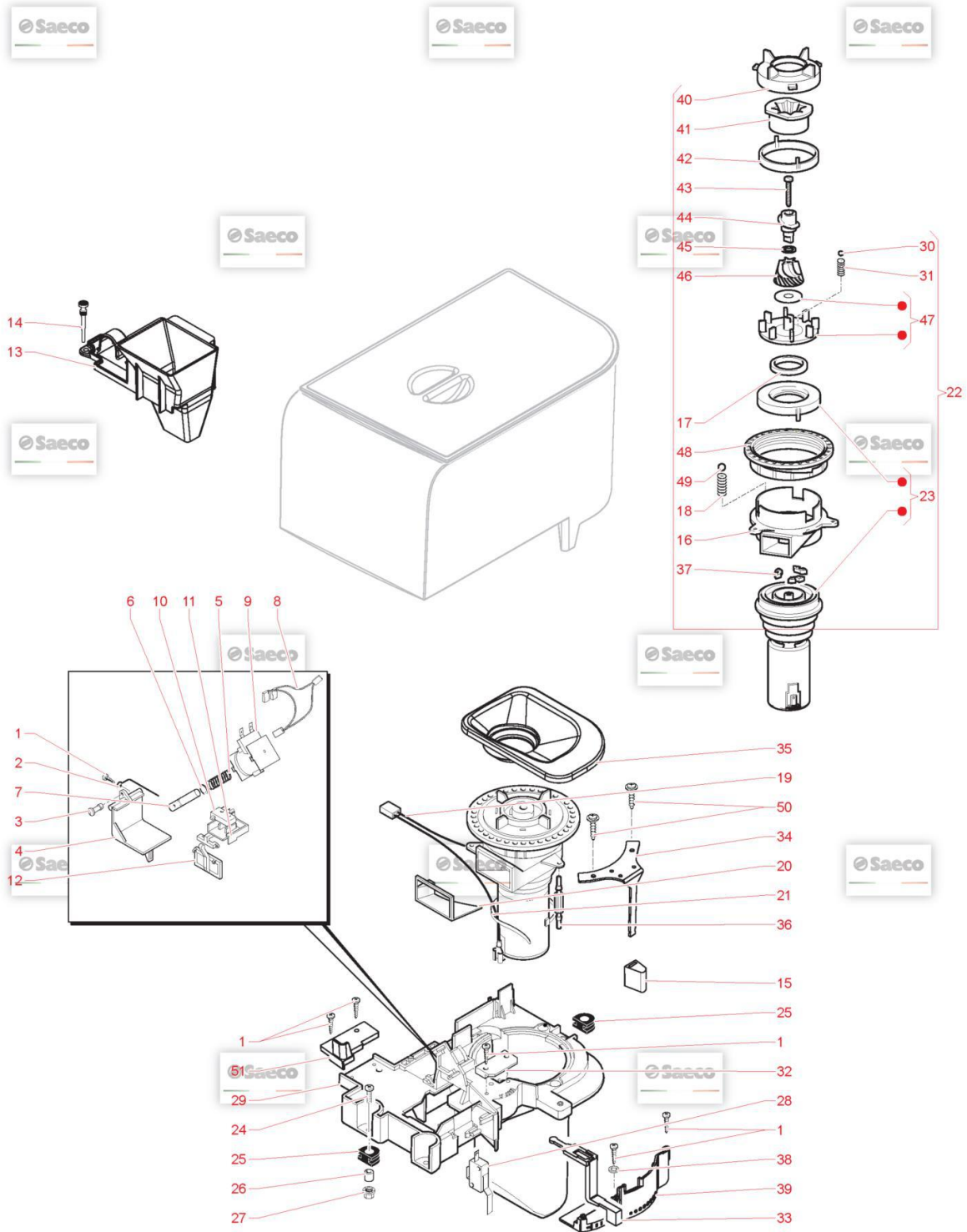























TAVOLA NR. 6 - ARTICOLO SAECO AULIKA TOP



## Model Machine

MACSAE198













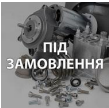













SAECO AULIKA TOP

Web	Pos.	Foto	Item - Replace by	Description
				<i>Press - CTRL + CLICK go to item in a new window Натисніть - Ctrl + права кнопка миші щоб відкрити запчастину в новому вікні</i>
	1		129913902	SCREW TCB TORX 10 3X12 PLAST.ZN-B SCREW TCB TORX 10 3X12 PLAST.ZN-B
	2		9161.048	STEEL GROUND COF.DOSER SCRAPERROD ASTA RASATORE
	3		9161.076.150	GREY GROUND COF.DOSER DOOR PIN PERNO SPORTELLO DOSATORE GRIGIO
	4		9161.074.150	GREY GROUND COFFE DOSER DOOR SPORTELLO DOSATORE GRIGIO
	5		126764818	ПРУЖИНА ЕЛЕКТРОМАГНІТНОГО ДОЗАТОРА ЗЕРНА MAGIC SAECO 916... SPRING ELECTROM.BEAN DOSER MAGIC
	6		U701.003	SNAP RING 7 UNI 7434 ANELLO ELASTICO 7 UNI 7434
	7		9161.041	STEEL GROUND COF.DOSER ELECTROMAGN.CORE NUCLEO ELETTRMAGNETE DOSATORE
	8	 ПІД ЗАМОВЛЕННЯ	421946000541	4P.CONN.COIL+DOSER MICRO V2 RYL UL ASSY. 4P.CONN.COIL+DOSER MICRO V2 RYL UL ASSY.
	9		11025734	DOSER COIL FOR SUPERAUTOM.24VDC ASSY. DOSER COIL FOR SUPERAUTOM.24V DC ASSY.
	10		NE05.017	MICROSWITCH MICROSWITCH NE05.017
	11		9161.072.150	GREY MICRO SUPP.CURSOR GROUNDCOF.DOSER MICRO SUPPORT CURSOR GREY
	12		9161.073.150	GREY GROUND COF.DOSE CONTROL COMPENSATOR DOSE CONTROL COMPENSATOR GREY
	13		17000176	BLACK HOPPER FOR POWDER COFFEERYL BLACK HOPPER FOR POWDER COFFEE RYL

## Model Machine

MACSAE198























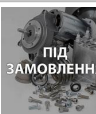

SAECO AULIKA TOP

	14		<b>9161.082</b>	RUBBER COUPLER <i>AGGANCIO IN GOMMA</i>
	15		<b>0333.009</b>	BLK GRINDING ADJUST.LEVER HANDGRIP ROYAL <i>BLK GRINDING ADJUST.LEVER HANDGRIP ROYAL</i>
	16		<b>9141.080</b>	ТРИМАЧ ДВИГУНА КАВОМОЛКИ ДЛЯ КАВОВАРКИ SAECO 9141.080 <i>SUPPORTO MOTORE</i>
	17		<b>140360200</b>	FELT RING 40X34X5 <i>ANELLO IN FELTRO DE=40 DI=34</i>
	18		<b>126770117</b>	NEW SPRING SPHERE D=3,2 MOTORMAGIG <i>MOLLA NEW X SFERA D=3,2 MOTORE MAGIC</i>
	19		<b>421946000531</b>	2P.CONN.GRINDER MOTOR V2 RYL UL ASSY. <i>2P.CONN.GRINDER MOTOR V2 RYL UL ASSY.</i>
	20		<b>1505.014</b>	COFFEEGRINDER SEAL <i>GUARNIZIONE DOSATORE</i>
	21		<b>144320200</b>	SELF LOCK STRIP W=2.6 L=200 <i>SELF LOCK STRIP W=2.6 L=200</i>
	22		<b>9140.036.00A</b>	КАВОМОЛКА В ЗБОРИ 230V PHILIPS SAECO 996530065687 <i>COFFEE GRINDER STD 230V ASSY.</i>
	22		<b>9140.036.00F</b>	ASS.MOTOR STD 120V <i>ASS.MOTOR STD 120V</i>
	23		<b>0301.R10.00A</b>	SPARE MOTOR UNIT MC 230V <i>GRUPPO RICAMBIO MOTORE MC 230 V</i>
	23		<b>0301.R10.00F</b>	SPARE MOTOR UNIT MC 120V <i>SPARE MOTOR UNIT MC 120V</i>
	24		<b>U043.004</b>	ZN-B TCB TORX 20 M4X16 ZN-B <i>VITE TCBC M4,0X16 UNI 7687 ZNP</i>
	25		<b>9991.005</b>	RUBBER FOR COFFEE GRINDER <i>GOMMINO X MACINA CAFFE</i>

## Model Machine

MACSAE198











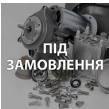





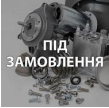



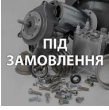

SAECO AULIKA TOP

	26		9141.003	SPACER FOR RUBBER SPACER FOR RUBBER
	27		U324.006	ШАЙБА M4 NUT M4 FLANGED INDENTED BASE
	28		12001605	МІКРИК MICROSWITCH
	29		9161.365.150	GREY PLATE COFFEEGRINDER MAGIC/ROYAL PIASTRA X MACINACAFFE' GRIGIO/7016
	30		128610521	STAIL.STEEL AISI 304 SPHERE D=5,5MM SFERA D=5,5MM ACCIAIO INOX A
	31		126765517	STEEL SPRING SPHERE D=5,5 MOTOR MAGIC MOLLA ACC.X SFERA D=5,5 MOTO
	32	 ПІД ЗАМОВЛЕННЯ	9161.097.150	GREY GROUND COF.DOSER LEVER FIXING PLATE LEVER FIXING PLATE GREY
	33		0313.003.150	7016/GREY GROUND COF.DOSER ADJUSTM.LEVER LEVA DI REGOLAZIONE GRIGIO R
	34		0333.008	STEEL GRINDING ADJUSTMENT LEVER STEEL GRINDING ADJUSTMENT LEVER
	35		17000238	COFFEE GRINDER SOUNDPROOFING COVER RYL COFFEE GRINDER SOUNDPROOFING COVER RYL
	36		9991.103	АМОРТИЗАТОР ДЛЯ КОФЕМОЛКИ КОФЕМАШИН PHILIPS SAECO 996530... AMMORTIZZATORE PER MACINACAFE
	37		140230400	SHOCK ABS .CONICAL GRINDER SUPP.MAGIC AMMORTIZ.X SUPPOR.MACIN.CONI
	38		U201.001	PLAIN WASHER 3,2X9 DIN 7349 GALV. PLAIN WASHER 3,2X9 DIN 7349 GALV.

## Model Machine

MACSAE198

SAECO AULIKA TOP

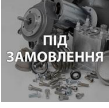
	39		17000832	GRY COFF.GRINDING/DOSE ADJUST.SCALE RYLO GRY COFF.GRINDING/DOSE ADJUST.SCALE RYLO
	40		149186150	BLACK UPPER GRINDER SUPPORT MAGIC SUPPORT.NER.X MACINA SUPERIO
	42		142844550	UPPER GRINDER COVER COFFEE GRIND. MAGIC UPPER GRINDER COVER COFFEE GRIND. MAGIC
	43		129931002	TORX SCREW T10 TCB 3,5X40 SX ZNG TORX SCREW T10 TCB 3,5X40 SX ZNG
	44		147470763	BLK INCREASE SCREW PIN COF.GRINDER MAGIC PERNO INCREM.A VITE X MACINA
	45		U201.002	PLAIN WASHER 10X16X0,2DIN 988GAL ROSETTA PIANA 10X16X0,2DIN
	46		226477700	KIT ITAL MILL GRINDERS COPPIA DI MACINE SAECO CONICHE
	47		149188750	CONICAL GRIND. SUPP. + RING MAGIC CONICAL GRIND. SUPP. + RING MAGIC
	48		146570950	RING NUT FOR GRINDING ADJUSTMENT MAGIC GHIERA NERA REGOLAZ.MACINATU
	49		128610421	STAIL.STELL AISI 304 SPHERE D=3,2MM SFERA D=3,2MM ACCIAIO INOX A
	50		12000450	SCREW TCBR TORX 10 3,5X12 PLAST.ZN-N SCREW TCBR TORX 10 3,5X12 PLAST.ZN-N
	51		17001155	GREY COVER FOR DOSER HOLE RYL GREY COVER FOR DOSER HOLE RYL

# Model Machine

MACSAE198

SAECO AULIKA TOP

MACSAE198.T.0007



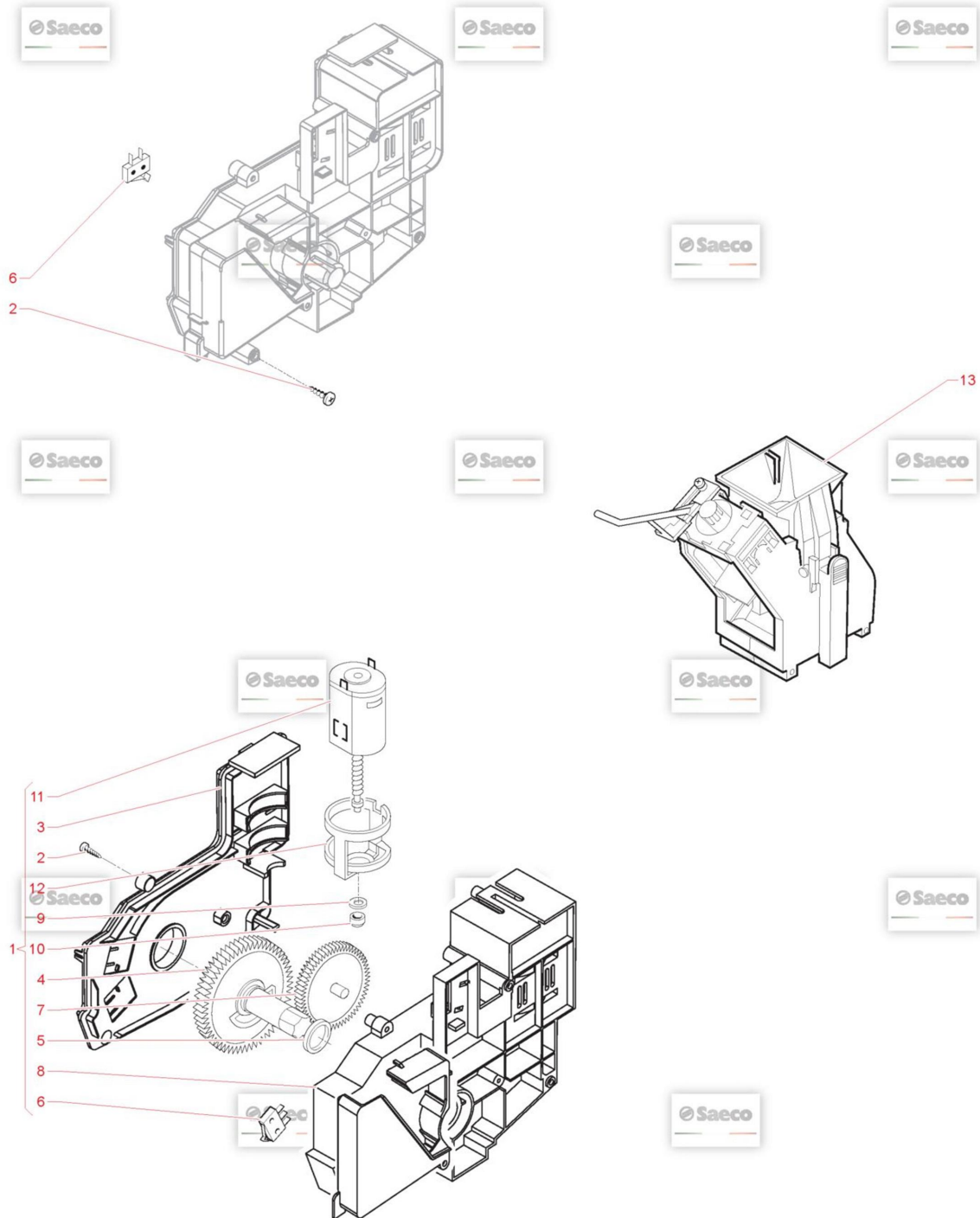























TAVOLA NR. 7 - ARTICOLO SAECO AULIKA TOP



## Model Machine

MACSAE198

SAECO AULIKA TOP

Web	Pos.	Foto	Item - Replace by	Description
				<i>Press - CTRL + CLICK go to item in a new window Натисніть - Ctrl + права кнопка миші щоб відкрити запчастину в новому вікні</i>
	1		11025736	РЕДУКТОР ВЗБОРИ PHILIPS SAECO 996530068554 RATIOMOTOR RYL ASSY.
	2		129670202	TCB PANELVIT SCREW 3,5X16 TESTA D=8 ZNP TCB PANELVIT SCREW 3,5X16 TESTA D=8 ZNP
	3		17000719	GREY RATIOMOTOR LID RYL GREY RATIOMOTOR LID RYL
	4		11007137	BLACK GEAR Z=77 V2 FOR RATIOMOTOR P124 BLACK GEAR Z=77 V2 FOR RATIOMOTOR P124
	5		9161.368	MYLAR WASHER FOR RATIOMOTOR RONDELLA MYLAR X MOTORIDUTTORE
	6		NE05.038	MICROSWITCH 30V 0.3A MICROINTERRUTTORE
	7		146002800	GREY GEAR Z=13/90 FOR RATIOMOTOR P124 GREY GEAR Z=13/90 FOR RATIOMOTOR P124
	8		11026258	GREY RATIOMOTOR CASING WITH TUBE ASSY. GREY RATIOMOTOR CASING WITH TUBE ASSY.
	9		148380200	BAKELIZZATE WASHER D=5,5 BAKELIZZATE WASHER D=5,5
	10		9121.046	BRONZE SINTERED BUSH FOR MOTORRATIOMOT. BRONZE SINTERED BUSH FOR MOTOR RATIOMOT.
	11		11005214	MOTOR FOR RATIOMOTOR ASSY. MOTOR FOR RATIOMOTOR P124 ASSY
	12		9121.044	ANTIVIBRATION FOR MOTOR ANTIVIBRANTE X MOTORE
	13		11003800	BLACK BREW UNIT BLACK BREW UNIT MAGIC/ROYAL





# Model Machine

MACSAE198

SAECO AULIKA TOP

MACSAE198.T.0008



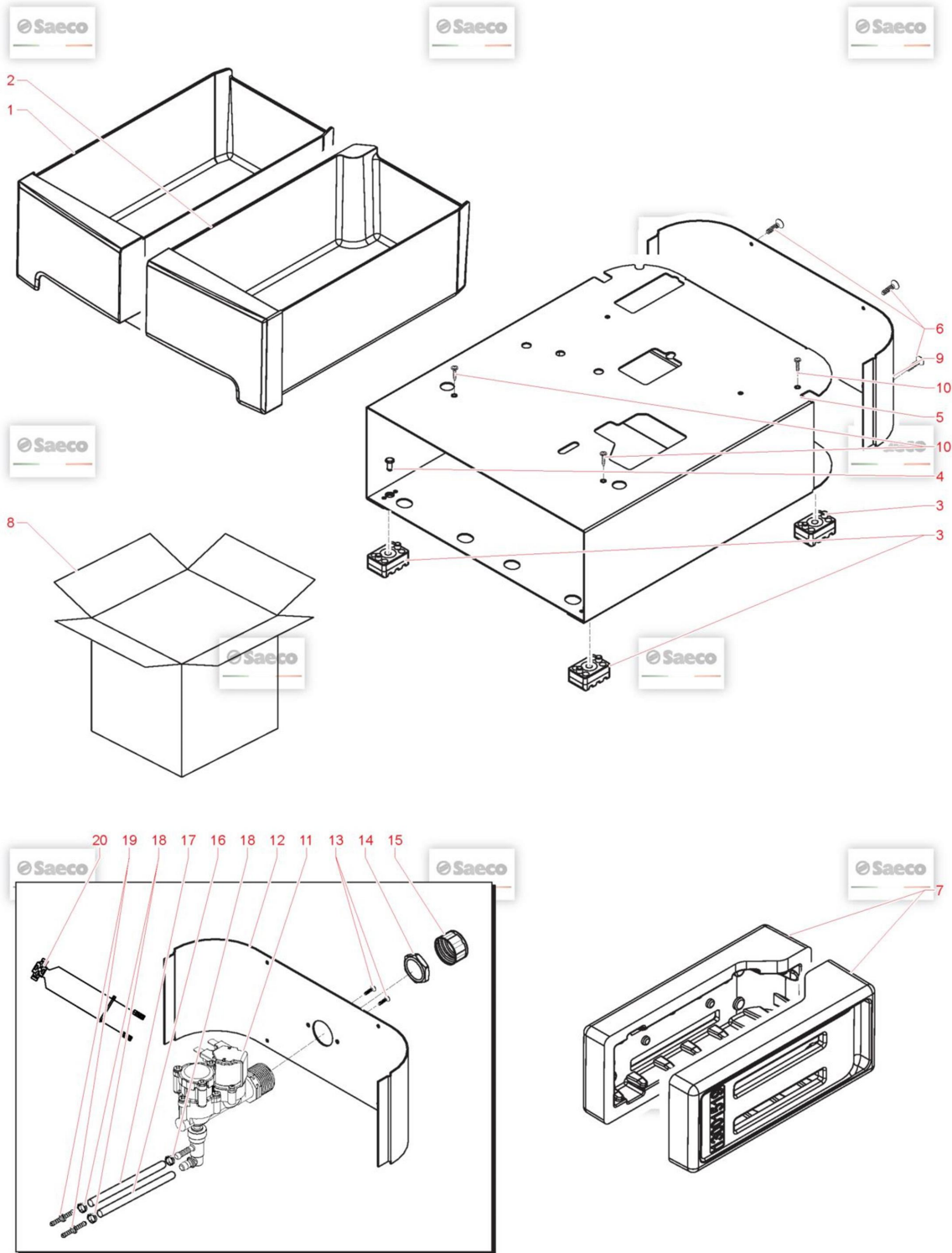























TAVOLA NR. 8 - ARTICOLO SAECO AULIKA TOP

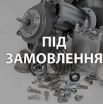

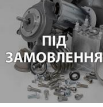
## Model Machine

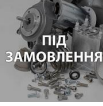
MACSAE198













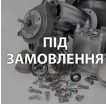

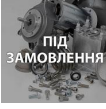

SAECO AULIKA TOP

Web	Pos.	Foto	Item - Replace by	Description
				<i>Press - CTRL + CLICK go to item in a new window Натисніть - Ctrl + права кнопка миші щоб відкрити запчастину в новому вікні</i>
	1		11029731	CRC BASE REPOSITORY DRAWER RYLO CRC BASE REPOSITORY DRAWER RYLO
	1		421941302441	ШУХЛЯДА ЛІВА, ЧОРНА ДЛЯ БАЗОВОЇ ПІДСТАВКИ TXO/BLK BASE REPOSITORY DRAWER RYLO
	2		11029719	CRC BASE DUMP BOX RYLO ASSY. CRC BASE DUMP BOX RYLO ASSY.
	2		421941302531	TXO/BLK BASE DUMP BOX RYLO ASSY. TXO/BLK BASE DUMP BOX RYLO ASSY.
	3		11021829	ФІКСУЮЧИЙ НІС НИЖНІЙ ЧАСТИНИ КОРПУСУ (НІЖКИ) PHILIPS SAECO 9... BLACK/TRANSP.RIGID FOOT MYB9
	4		11021769	BLACK RIGID FOOT FIXING PIN MYB9 BLACK RIGID FOOT FIXING PIN MYB9
	5		421946005111	BLK STEEL BASE CASING V2 RYLO ASSY. BLK STEEL BASE CASING V2 RYLO ASSY.
	6		12001622	SCREW TCB TORX B 3,5X9,5 SCHEET NIK SCREW TCB TORX B 3,5X9,5 SCHEET NIK
	7		13001519	PS-E INSERT FOR BOX BASE RYLO PS-E INSERT FOR BOX BASE RYLO
	8		13001676	HAVANA BOX V2 BASE RYLO HAVANA BOX V2 BASE RYLO
	9		11029700	BLACK BASE REAR PANEL RYLO BLACK BASE REAR PANEL RYLO
	10		129914302	SCREW TORX M4X10 TESTA D=8X1,5 GALV SCREW TORX M4X10 TESTA D=8X1,5 GALV
	11		17001582	НАДЛИШКОВИЙ КЛАПАН ВИСОКОГО ТИСКУ SAECO SS-7117001582 CONNECT.WATER SUPPLY RYLO RI ASSY.

## Model Machine

MACSAE198

SAECO AULIKA TOP



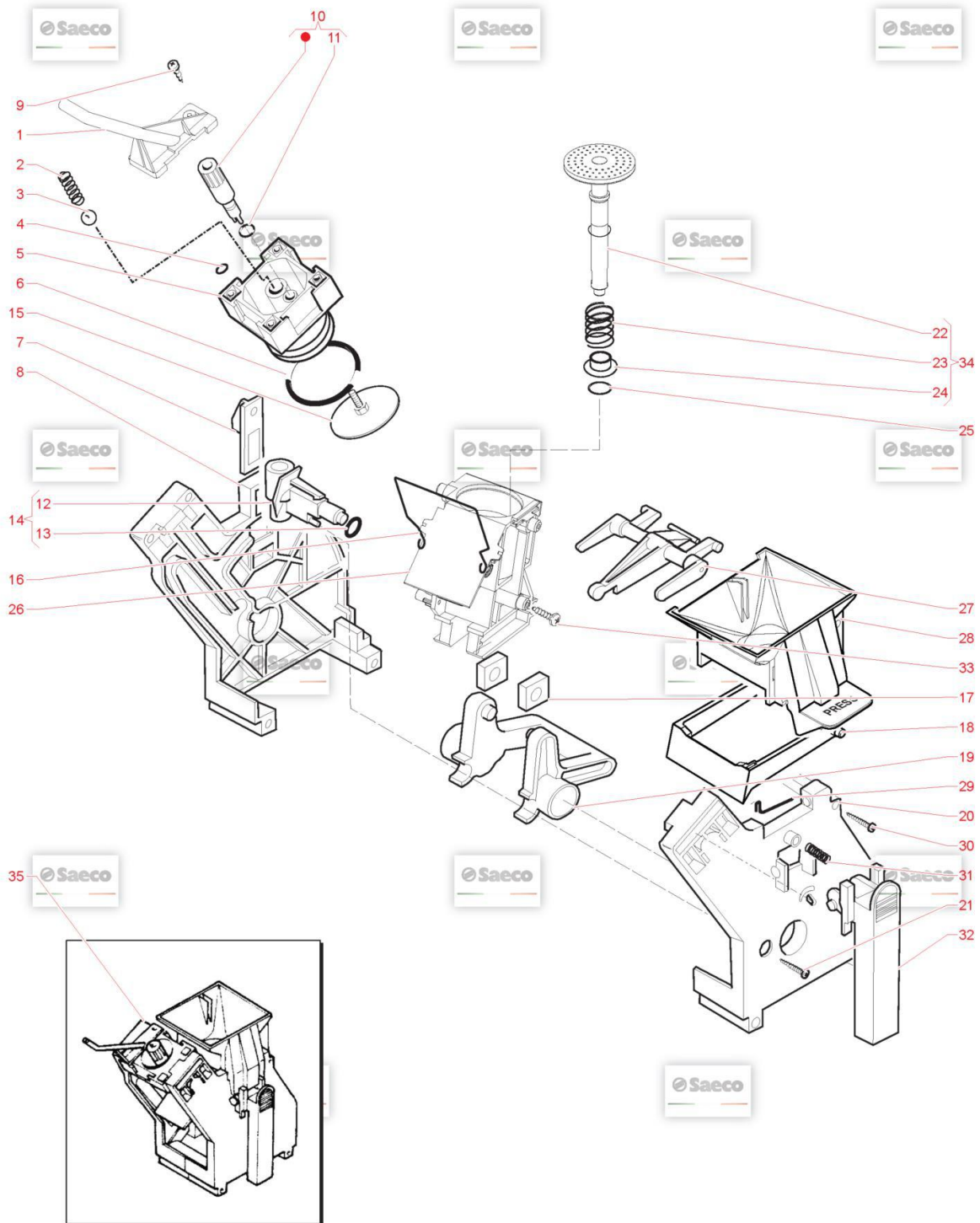























	12		11029701	BLACK BASE REAR PANEL RYLO RI <i>BLACK BASE REAR PANEL RYLO RI</i>
	13		129912104	SCREW TCBR TORX 20 4X10 PLAST.ZN-N <i>SCREW TCBR TORX 20 4X10 PLAST.ZN-N</i>
	14		NV99.075	GHIERA IN NYLON G3/4" 6 MM. <i>"GHIERA IN NYLON G3/4" 6 MM.</i>
	15		NV03.002	CAP 3/4 "KAPSTO 800R 3/4" <i>"CAP 3/4 "KAPSTO 800R 3/4""</i>
	16		JS01.022	SILICONE TUBE 5X10 60SH IN ROLL <i>SILICONE TUBE 5X10 60SH IN ROLL</i>
	17		16000380	5X8,9 SILICONE TUBE IN ROLL <i>5X8,9 SILICONE TUBE IN ROLL</i>
	18		12000892	ЗАЖИМ D.9,5 16700004 <i>OETIKER CLAMP D=9,5 16700004 ( L250 )</i>
	19		17001018	BLACK WATER SUPPLY CONNECTOR RYLO RI <i>BLACK WATER SUPPLY CONNECTOR RYLO RI</i>
	20		421946001221	3P.CONN.SUPPLY COIL V2 RYLO RIUL ASSY. <i>3P.CONN.SUPPLY COIL V2 RYLO RI UL ASSY.</i>



## Model Machine

MACSAE198





























SAECO AULIKA TOP

Web	Pos.	Foto	Item - Replace by	Description
				<i>Press - CTRL + CLICK go to item in a new window Натисніть - Ctrl + права кнопка миші щоб відкрити запчастину в новому вікні</i>
	1		11003789	BLACK COFF.OUTLET SLEEVE BREWUNIT ROYAL <i>BLACK COFF.OUTLET SLEEVE BREW UNIT ROYAL,AULIKA MAGIC SAECO</i>
	2		9161.222	SS.CONICAL SPRING <i>MOLLA CONICA</i>
	3		9991.168	GLASS SPHERE D.5 MM <i>SFERA IN VETRO D.5 MM</i>
	4		11021334	BLK COUNTERPISTON SEAL DE=11 DI=8 SP=1,4 <i>BLK COUNTERPISTON SEAL DE=11 DI=8 SP=1,4</i>
	5		11003796	BLACK BREW UNIT COUNTERPISTONM5000 <i>BLACK BREW UNIT COUNTERPISTON M5000</i>
	6		NM01.044	OR ORM 0320-40 SILICONE PTFE/FDA <i>OR ORM 0320-40 SILICONE PTFE</i>
	7		11004114	BLACK BREW UNIT COUPLING PLATE <i>BLACK BREW UNIT COUPLING PLATE</i>
	8		421941158532	BLACK BREW UNIT REAR PLATE V2M5000 <i>BLACK BREW UNIT REAR PLATE V2 M5000</i>
	9		U140.019	SCREW TCB TORX 10 3X16 PLAST SS <i>PANELVIT TCB 3,0X16 DIN 7505</i>
	10		227470150	PIN BLACK ASS.FOR PERCOLATOR <i>PIN BLACK ASS.FOR PERCOLATOR</i>
	11		NM02.006	OR R5 TERMOIL <i>OR R5 EPDM</i>
	12		9161.064.050	BLACK WATER INLET SLEEVE BREWUNIT ROYAL <i>BLACK WATER INLET SLEEVE BREW UNIT ROYAL</i>
	13		NM02.007	OR 2025 IN TERMOIL <i>OR 2025 TERMOIL</i>

## Model Machine

MACSAE198











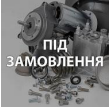

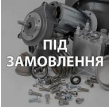

SAECO AULIKA TOP

	14		<b>20000440</b>	BLACK WATER INLET SLEEVE BREWUNIT ASSY. <i>BLACK WATER INLET SLEEVE BREW UNIT ASSY.</i>
	15		<b>9160.075</b>	PERCOLATOR DE=35,8 ELFO ASSY. <i>PERCOLATOR DE=35,8 ELFO ASSY.</i>
	16		<b>11001556</b>	SS BREW UNIT SPRING H=49 SMART <i>SS BREW UNIT SPRING H=49 SMART</i>
	17		<b>9161.094.050</b>	BLACK BREW UNIT DRILLED BLOCK <i>BLACK BREW UNIT DRILLED BLOCK</i>
	18		<b>11004161</b>	BLACK SCRAPER FOR BREW UNIT M5000 <i>BLACK SCRAPER FOR BREW UNIT M5000</i>
	19		<b>9161.066.050</b>	BLACK BREW UNIT ELBOW SHAFT M5000 <i>BLACK BREW UNIT ELBOW SHAFT M5000</i>
	20	 ПІД ЗАМОВЛЕННЯ	<b>11003793</b>	BLACK BREW UNIT FRONT PLATE M5000 <i>BLACK BREW UNIT FRONT PLATE M5000</i>
	21		<b>12000550</b>	CAMOPI3 TCB TORX 10 3X25 PLAST.SS <i>SCREW TCB TORX 10 3X25 PLAST.SS</i>
	22	 ПІД ЗАМОВЛЕННЯ	<b>11003077</b>	BLK BREW UNIT INTEGRAL PISTON8GR.ASSY. <i>BLK BREW UNIT INTEGRAL PISTON 8GR.ASSY.</i>
	23		<b>9161.198</b>	SS.8GR.BREW UNIT PISTON SPRING <i>SS.8GR.BREW UNIT PISTON SPRING</i>
	24		<b>9161.191</b>	WHITE 8GR.-12GR.BREW UNIT PISTON BUSH <i>BOCCOLA X PISTONE NEUTRO</i>
	25		<b>NM02.018</b>	OR ORM 0090-25 TERMOIL <i>OR ORM 0090-25 TERMOIL</i>
	26		<b>421944014611</b>	BLK COF.CONTAIN.BREW UNIT V2 M5000 ASSY. <i>BLK COF.CONTAIN.BREW UNIT V2 M5000 ASSY.</i>
	27		<b>11003078</b>	BLACK CONNECTING ROD BREW UNIT 8GR. <i>BLACK CONNECTING ROD BREW UNIT 8GR.</i>

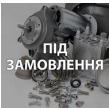
## Model Machine

MACSAE198

SAECO AULIKA TOP

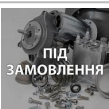
	28		11003795	BLACK HOPPER COFF.BREW UNIT S/SCR.M5000 <i>BLACK HOPPER COFF.BREW UNIT S/SCR.M5000</i>
	29		9161.046	ПРУЖИНА ВОРОНКИ ЗАВАРОЧНОГО БЛОКА ДЛЯ КОФЕМАШИН PHILIPS ... <i>MOLLA X RASATORE GRUPPO</i>
	30		12000897	SCREW TCB TORX 10 3,5X20 PLAST.SS <i>SCREW TCB TORX 10 3,5X20 PLAST.SS</i>
	31		9161.045	SS BREW UNIT HANDGRIP SPRING M5000 <i>MOLLA X IMPUGNATURA GRUPPO</i>
	32		11003791	BLACK BREW UNIT HANDGRIP M5000 <i>BLACK BREW UNIT HANDGRIP M5000</i>
	33		129912521	SCREW TCBR TORX 10 3,5X14 PLAST.SS <i>SCREW TCBR TORX 10 3,5X14 PLAST.SS</i>
	34		11023086	BLK 8GR.BREW UNIT NTEGR.PISTONGEN.ASSY. <i>BLK 8GR.BREW UNIT NTEGR.PISTON GEN.ASSY.</i>
	35		11003800	BLACK BREW UNIT <i>BLACK BREW UNIT MAGIC/ROYAL</i>



## Model Machine

MACSAE198

SAECO AULIKA TOP

MACSAE198.T.0010

TAVOLA NR. 10 - ARTICOLO SAECO AULIKA TOP

## Model Machine

MACSAE198

SAECO AULIKA TOP

Web Pos. Foto Item - Replace by Description



*Press - CTRL + CLICK go to item in a new window  
Натисніть - Ctrl + права кнопка миші щоб відкрити запчастину в новому вікні*



1

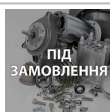

11035702

ANT/L PAINTED CONTAINERS LID RYLO ASSY.  
COP.CONTENTITORI RYLO VERN.ANT/L D/AS.



2



421941301061

TXO/BLK CONTAINERS LID RYLO TOASSY.  
TXO/BLK CONTAINERS LID RYLO TO ASSY.



3

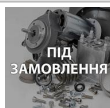

421941301051

UNPAINT.BLK CONTAINERS LID RYLO  
COP.CONTENTITORI RYLO NER.D/VERN.



4

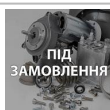

17001987

STEEL CONTAINERS LID LOCK BRACKET RYLO  
STEEL CONTAINERS LID LOCK BRACKET RYLO



5



12001902

LOCK MERONI 337  
LOCK MERONI 337



6

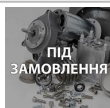

11004160

D=6 H=4 MAGNET P0049  
D=6 H=4 MAGNET P0049



7

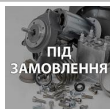

12001431

SCREW TCB TORX 10 3X12 PLAST.SS  
SCREW TCB TORX 10 3X12 PLAST.SS



8



11025841

TRANSP/GREY BEAN CONTAINER RYLO  
NAT/GREY BEAN CONTAINER RYLO



9



11025844

BLACK BEAN COFFEE CONTAIN.LIDRYLO ASSY.  
BLACK BEAN COFFEE CONTAIN.LID RYLO ASSY.



10

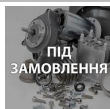

11035701

G/ANT W/LOCK CONTAINERS LID RYLO ASSY.  
AS.COP.CONT.C/SERRATURA RYLO ANT/L



11

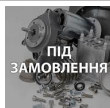

421941301071

TXO/BLK W/LOCK CONTAINERS LIDRYLO ASSY.  
AS.COP.CONT.C/SERRATURA RYLO NER/TXO



12

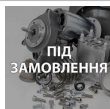

11035209

BLK W/LOCK CONTAINERS LID RYLOASSY.  
AS.COP.CONT.C/SERRATURA RYLO NER



13













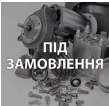















11025848

BLACK WATER CONTAINER LID RYLO  
COPERCHIO.CONTENTITORE.ACQUA.NERO LID RYLO

## Model Machine

MACSAE198

















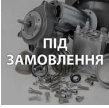





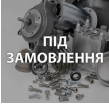



SAECO AULIKA TOP

	14		<b>144650800</b>	WHITE WATER CONTAINER EXT.FILTER <i>WHITE WATER CONTAINER EXT.FILTER</i>
	15		<b>140328461</b>	ПРОКЛАДКА O-RING 0190-10 ДЛЯ КОФЕМАШИНЫ PHILIPS SAECO 99653... <i>OR METRICO 0190-10 IN EPDM NUOVO PREZZO 0,13</i>
	16		<b>140324362</b>	OR ORM 0060-30 SILICONE <i>OR METRIC 0060-30 IN SILICONE</i>
	17		<b>126764718</b>	SS WATER CONTAINER VALVE SPRING <i>SS WATER CONTAINER VALVE SPRING</i>
	18		<b>147660562</b>	GREY PISTON FOR WATER CONTAINER VALVE <i>GREY PISTON FOR WATER CONTAINER VALVE</i>
	19		<b>17001255</b>	ЗАТИЧКА 1 ШТ <i>BLACK PLUG FOR WATER CONTAIN.HANDLE RYL</i>
	20		<b>11025847</b>	BLACK HANDLE WATER CONTAINER LID RYLO <i>BLACK HANDLE WATER CONTAINER LID RYLO</i>
	21		<b>11029967</b>	TRANSP/GREY WATER CONTAINER S/SCR.RYLO <i>TRANSP/GREY WATER CONTAINER S/SCR.RYLO</i>
	22		<b>11035696</b>	G/ANT CASING COVER S/SCR.RYLOASSY. <i>AS.COP.CARC.RYLO ANT/L SER.</i>
	23		<b>224640200</b>	БІЛИЙ ПЛАСТИКОВИЙ ФІЛЬТР У КОНТЕЙНЕР ВОДИ SAECO 996530029115 <i>EXTERNAL FILTER FOR WATER CONTAINER ASSY</i>
	24		<b>11025846</b>	TRANSP/GREY WATER CONTAINER RYLO ASSY. <i>NAT/GREY WATER CONTAINER RYLO ASSY.</i>
	25		<b>11030103</b>	CRC FRONT PANEL RYLO <i>CRC FRONT PANEL RYLO</i>
	26		<b>421941306721</b>	ПЛАТА-СЕНСОР РІВНЯ ВОДИ V3 A <i>CPU+SW WATER LEVEL SENSOR V3 ASSY.</i>
	27		<b>17001444</b>	BLACK WATER LEVEL SENSOR SUPPORT RYLO <i>BLACK WATER LEVEL SENSOR SUPPORT RYLO</i>

## Model Machine

MACSAE198

SAECO AULIKA TOP

	28		12000450	SCREW TCBR TORX 10 3,5X12 PLAST.ZN-N SCREW TCBR TORX 10 3,5X12 PLAST.ZN-N
	29		17000829	BLACK BEAN CONTAINER SENSOR SUPPORT RYLO BLACK BEAN CONTAINER SENSOR SUPPORT RYLO
	30	 ПІД ЗАМОВЛЕННЯ	11035697	ANT/L CASING COVER RYLO/T COP.CARC.RYLO/T VERN.ANT./L
	31	 ПІД ЗАМОВЛЕННЯ	11036480	TOP COVER RYLO/T UL PAINT.ANT TOP COVER RYLO/T UL PAINT.ANT
	32	 ПІД ЗАМОВЛЕННЯ	421944010501	TXO/BLK CASING COVER RYLO/T TXO/BLK CASING COVER RYLO/T
	33	 ПІД ЗАМОВЛЕННЯ	11031658	UNPAINTED CASING COVER RYLO/T UNPAINTED CASING COVER RYLO/T
	34	 ПІД ЗАМОВЛЕННЯ	17000422	TRANSP.INFRAREDS PLATE RYL TRANSP.INFRAREDS PLATE RYL
	35		0701.031.150	GREY WATER VALVE GACO DIM 14 SEAL COVER SEAL COVER GREY
	36		145842900	NBR WATER CONT.VALVE GACO DIM14 SEAL NBR WATER CONT.VALVE GACO DIM14 SEAL
	37		12000895	SCREW TSP TORX 10 3X10 PLAST.SS SCREW TSP TORX 10 3X10 PLAST.SS
	38		0701.014.150	GREY WATER VALVE GACO DIM 14 SEAL CONT. GREY WATER VALVE GACO DIM 14 SEAL CONT.
	39	 	140320461	OR ORM 0080-20 TERMOIL OR ORM 0080-20 IN TERMOIL
	40	 ПІД ЗАМОВЛЕННЯ	11034510	BLK CASING COVER S/SCR.RYLO V2ASSY. AS.COP.CARC.RYLO V2 BLK SER.

## Model Machine

MACSAE198

SAECO AULIKA TOP



41

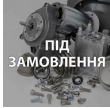

11036439

TOP COVER RYLO ANT/L SER.UL ASSY  
*TOP COVER RYLO ANT/L SER.UL ASSY*



42

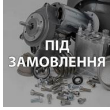

11036005

KR BLK/L CASING COVER S/SCR.RYLO/T ASSY.  
*KR BLK/L CASING COVER S/SCR.RYLO/T ASSY.*



43

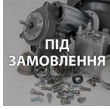

11000117

BLK CAS.COV. S/SCR.RYLOV2 ASSY  
*BLK CAS.COV. S/SCR.RYLOV2 ASSY*

## Model Machine

MACSAE198

SAECO AULIKA TOP

























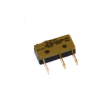

MACSAE198.T.0011

TAVOLA NR. 11 - ARTICOLO SAECO AULIKA TOP

## Model Machine

MACSAE198

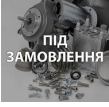



























SAECO AULIKA TOP

Web	Pos.	Foto	Item - Replace by	Description
				<i>Press - CTRL + CLICK go to item in a new window Натисніть - Ctrl + права кнопка миші щоб відкрити запчастину в новому вікні</i>
	1		129913902	SCREW TCB TORX 10 3X12 PLAST.ZN-B SCREW TCB TORX 10 3X12 PLAST.ZN-B
	2		9161.076.150	GREY GROUND COF.DOSER DOOR PIN PERNO SPORTELLO DOSATORE GRIGIO
	3		9161.048	STEEL GROUND COF.DOSER SCRAPERROD ASTA RASATORE
	4		9161.074.150	GREY GROUND COFFE DOSER DOOR SPORTELLO DOSATORE GRIGIO
	5		9161.041	STEEL GROUND COF.DOSER ELECTROMAGN.CORE NUCLEO ELETTROMAGNETE DOSATORE
	6		U701.003	SNAP RING 7 UNI 7434 ANELLO ELASTICO 7 UNI 7434
	7		126764818	ПРУЖИНА ЕЛЕКТРОМАГНІТНОГО ДОЗАТОРА ЗЕРНА MAGIC SAECO 916... SPRING ELECTROM.BEAN DOSER MAGIC
	8		11025734	DOSER COIL FOR SUPERAUTOM.24VDC ASSY. DOSER COIL FOR SUPERAUTOM.24V DC ASSY.
	9		NE05.017	MICROSWITCH MICROSWITCH NE05.017
	10	 ПІД ЗАМОВЛЕННЯ	421946000541	4P.CONN.COIL+DOSER MICRO V2 RYL UL ASSY. 4P.CONN.COIL+DOSER MICRO V2 RYL UL ASSY.
	11		9161.072.150	GREY MICRO SUPP.CURSOR GROUND COF.DOSER MICRO SUPPORT CURSOR GREY
	12	 ПІД ЗАМОВЛЕННЯ	11036568	GROUND COF.DOSE CONTROL COMPENSATOR V2 BILANCERE CONTROL.DOSE CAF.MAC.BEIGE.V2
	13		1505.014	COFFEEGRINDER SEAL GUARNIZIONE DOSATORE

## Model Machine

MACSAE198

SAECO AULIKA TOP



















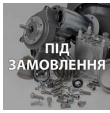

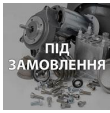

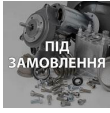

	14		9161.082	RUBBER COUPLER <i>AGGANCIO IN GOMMA</i>
	15		17000176	BLACK HOPPER FOR POWDER COFFEERYL <i>BLACK HOPPER FOR POWDER COFFEE RYL</i>
	16	 ПІД ЗАМОВЛЕННЯ	421946000531	2P.CONN.GRINDER MOTOR V2 RYL UL ASSY. <i>2P.CONN.GRINDER MOTOR V2 RYL UL ASSY.</i>
	17	 ПІД ЗАМОВЛЕННЯ	144320200	SELF LOCK STRIP W=2.6 L=200 <i>SELF LOCK STRIP W=2.6 L=200</i>
	18		9140.036.00A	КАВОМОЛКА В ЗБОРІ 230V PHILIPS SAECO 996530065687 <i>COFFEE GRINDER STD 230V ASSY.</i>
	19	 ПІД ЗАМОВЛЕННЯ	9140.036.00F	ASS.MOTOR STD 120V <i>ASS.MOTOR STD 120V</i>
	20		17000238	COFFEE GRINDER SOUNDPROOFING COVER RYL <i>COFFEE GRINDER SOUNDPROOFING COVER RYL</i>
	21		9991.103	АМОТИЗАТОР ДЛЯ КОФЕМОЛКИ КОФЕМАШИН PHILIPS SAECO 996530... <i>AMMORTIZZATORE PER MACINACAFE</i>
	22		0333.008	STEEL GRINDING ADJUSTMENT LEVER <i>STEEL GRINDING ADJUSTMENT LEVER</i>
	23		12000450	SCREW TCBR TORX 10 3,5X12 PLAST.ZN-N <i>SCREW TCBR TORX 10 3,5X12 PLAST.ZN-N</i>
	24	 ПІД ЗАМОВЛЕННЯ	11027917	COFFEE GRINDER STD CALIBRATED230V ASSY. <i>AS.MACINACAFFE STD TARATO 230V</i>
	25		149186150	BLACK UPPER GRINDER SUPPORT MAGIC <i>SUPPORT.NER.X MACINA SUPERIO</i>
	26	 ПІД ЗАМОВЛЕННЯ	9141.039	UPPER GRINDER <i>UPPER GRINDER</i>
	27	 ПІД ЗАМОВЛЕННЯ	129931002	TORX SCREW T10 TCB 3,5X40 SX ZNG <i>TORX SCREW T10 TCB 3,5X40 SX ZNG</i>



## Model Machine

MACSAE198

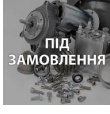

















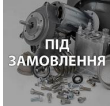

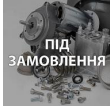



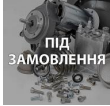

SAECO AULIKA TOP

	28		147470763	BLK INCREASE SCREW PIN COF.GRINDER MAGIC <i>PERNO INCREM.A VITE X MACINA</i>
	29		U201.002	PLAIN WASHER 10X16X0,2DIN 988GAL <i>ROSETTA PIANA 10X16X0,2DIN</i>
	30		128610521	STAIL.STEEL AISI 304 SPHERE D=5,5MM <i>SFERA D=5,5MM ACCIAIO INOX A</i>
	31		126765517	STEEL SPRING SPHERE D=5,5 MOTOR MAGIC <i>MOLLA ACC.X SFERA D=5,5 MOTO</i>
	32	 ПІД ЗАМОВЛЕННЯ	9141.042	SAFETY RING <i>SAFETY RING</i>
	33	 ПІД ЗАМОВЛЕННЯ	9141.028	BLACK LOWER GRINDER SUPPORT MAGIC <i>BLACK LOWER GRINDER SUPPORT MAGIC</i>
	34		140360200	FELT RING 40X34X5 <i>ANELLO IN FELTRO DE=40 DI=34</i>
	35	 ПІД ЗАМОВЛЕННЯ	0301.R10.00A	SPARE MOTOR UNIT MC 230V <i>GRUPPO RICAMBIO MOTORE MC 230 V</i>
	36		146570950	RING NUT FOR GRINDING ADJUSTMENT MAGIC <i>GHIERA NERA REGOLAZ.MACINATU</i>
	37		128610421	STAIL.STELL AISI 304 SPHERE D=3,2MM <i>SFERA D=3,2MM ACCIAIO INOX A</i>
	38		126770117	NEW SPRING SPHERE D=3,2 MOTORMAGIG <i>MOLLA NEW X SFERA D=3,2 MOTORE MAGIC</i>
	39	 ПІД ЗАМОВЛЕННЯ	9141.080	ТРИМАЧ ДВИГУНА КАВОМОЛКИ ДЛЯ КАВОВАРКИ SAECO 9141.080 <i>SUPPORTO MOTORE</i>
	40		140230400	SHOCK ABS .CONICAL GRINDER SUPP.MAGIC <i>AMMORTIZ.X SUPPOR.MACIN.CONI</i>

## Model Machine

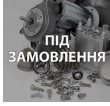
MACSAE198

















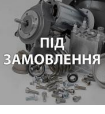

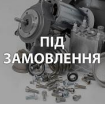
SAECO AULIKA TOP

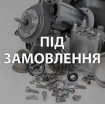
	41		<b>0301.R10.00F</b>	SPARE MOTOR UNIT MC 120V SPARE MOTOR UNIT MC 120V
	42		<b>142844550</b>	UPPER GRINDER COVER COFFEE GRIND. MAGIC UPPER GRINDER COVER COFFEE GRIND. MAGIC
	43		<b>9141.040</b>	CONICAL GRINDER CONICAL GRINDER
	44		<b>226477700</b>	KIT ITAL MILL GRINDERS COPPIA DI MACINE SAECO CONICHE
	45		<b>149188750</b>	CONICAL GRIND. SUPP. + RING MAGIC CONICAL GRIND. SUPP. + RING MAGIC
	46		<b>0333.009</b>	BLK GRINDING ADJUST.LEVER HANDGRIP ROYAL BLK GRINDING ADJUST.LEVER HANDGRIP ROYAL
	47		<b>U043.004</b>	ZN-B TCB TORX 20 M4X16 ZN-B VITE TCBC M4,0X16 UNI 7687 ZNP
	48		<b>17001155</b>	GREY COVER FOR DOSER HOLE RYL GREY COVER FOR DOSER HOLE RYL
	49		<b>9991.005</b>	RUBBER FOR COFFEE GRINDER GOMMINO X MACINA CAFFE
	50		<b>9141.003</b>	SPACER FOR RUBBER SPACER FOR RUBBER
	51		<b>U324.006</b>	ШАЙБА M4 NUT M4 FLANGED INDENTED BASE
	52		<b>9161.097.150</b>	GREY GROUND COF.DOSER LEVER FIXING PLATE LEVER FIXING PLATE GREY
	53		<b>12001605</b>	МІКРИК MICROSWITCH
	54		<b>421946000501</b>	2P.CONN.DOOR MICRO V2 RYL UL ASSY. 2P.CONN.DOOR MICRO V2 RYL UL ASSY.

## Model Machine

MACSAE198

SAECO AULIKA TOP

	55		9161.365.150	GREY PLATE COFFEEGRINDER MAGIC/ROYAL <i>PIASTRA X MACINACAFFE' GRIGIO/7016</i>
	56	 ПІД ЗАМОВЛЕННЯ	9161.077.150	DOSE ADJUSTMENT LEVER DE LUXEGREY <i>DOSE ADJUSTMENT LEVER DE LUXE GREY</i>
	57		U201.001	PLAIN WASHER 3,2X9 DIN 7349 GALV. <i>PLAIN WASHER 3,2X9 DIN 7349 GALV.</i>
	58	 ПІД ЗАМОВЛЕННЯ	17000832	GRY COFF.GRINDING/DOSE ADJUST.SCALE RYLO <i>GRY COFF.GRINDING/DOSE ADJUST.SCALE RYLO</i>
	59	 ПІД ЗАМОВЛЕННЯ	11036571	PLATE COFFEE GRIN.V2 GEN.RYLO230V ASSY. <i>PLATE COFFEE GRIN.V2 GEN.RYLO230V ASSY.</i>
	60	 ПІД ЗАМОВЛЕННЯ	421946000911	MICROSWITCH DOOR V2 RYL UL ASSY. <i>AS.MICRO SPORT.V2 RYL UL</i>
	61	 ПІД ЗАМОВЛЕННЯ	11028181	COFFEE GRINDER STD CALIBRATED120V ASSY. <i>AS.MACINACAFFE STD TARATO 120V</i>
	62	 ПІД ЗАМОВЛЕННЯ	421946000921	COIL WIRING+DOSER MICRO V2 RYLUL ASSY. <i>COIL WIRING+DOSER MICRO V2 RYLUL ASSY.</i>
	63	 ПІД ЗАМОВЛЕННЯ	9140.017	GREY GROUND COF.DOSER DOOR ASSY. <i>DOSER DOOR ASSEMBL.GREY</i>
	64	 ПІД ЗАМОВЛЕННЯ	11036572	PLATE COF.GRINDER V2 GEN.RYLO120V ASSY. <i>PLATE COF.GRINDER V2 GEN.RYLO120V ASSY.</i>

## Model Machine

MACSAE198

SAECO AULIKA TOP

MACSAE198.T.0012

TAVOLA NR. 12 - ARTICOLO SAECO AULIKA TOP

## Model Machine

MACSAE198

SAECO AULIKA TOP

Web Pos. Foto Item - Replace by Description



Press - CTRL + CLICK go to item in a new window  
Натисніть - Ctrl + права кнопка миші щоб відкрити запчастину в новому вікні



1



129670202

TCB PANELVIT SCREW 3,5X16 TESTA D=8 ZNP  
TCB PANELVIT SCREW 3,5X16 TESTA D=8 ZNP



2



17000719

GREY RATIOMOTOR LID RYL  
GREY RATIOMOTOR LID RYL



3



NE05.038

MICROSWITCH 30V 0.3A  
MICROINTERRUPTORE



4



11007137

BLACK GEAR Z=77 V2 FOR RATIOMOTOR P124  
BLACK GEAR Z=77 V2 FOR RATIOMOTOR P124



5



9161.368

MYLAR WASHER FOR RATIOMOTOR  
RONDELLA MYLAR X MOTORIDUTTORE



6



9121.039

STEEL PIN FOR RATIOMOTOR GEARMAGIC  
STEEL PIN FOR RATIOMOTOR GEARMAGIC



7



11005214

MOTOR FOR RATIOMOTOR ASSY.  
MOTOR FOR RATIOMOTOR P124 ASSY



8

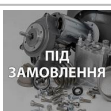

11003037

MOTOR FOR RATIOMOTOR ASSY.  
MOTOR FOR RATIOMOTOR ASSY.



9



9121.044

ANTIVIBRATION FOR MOTOR  
ANTIVIBRANTE X MOTORE



10



148380200

BAKELIZZATE WASHER D=5,5  
BAKELIZZATE WASHER D=5,5



11



9121.046

BRONZE SINTERED BUSH FOR MOTOR RATIOMOT.  
BRONZE SINTERED BUSH FOR MOTOR RATIOMOT.



12



146002800

GREY GEAR Z=13/90 FOR RATIOMOTOR P124  
GREY GEAR Z=13/90 FOR RATIOMOTOR P124



13



11026258

GREY RATIOMOTOR CASING WITH TUBE ASSY.  
GREY RATIOMOTOR CASING WITH TUBE ASSY.

## Model Machine

MACSAE198

SAECO AULIKA TOP



14

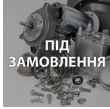

11034990

RATIOMOTOR RYL V2 ASSY.

AS.MOTORID.RYL V2

## Model Machine

MACSAE198

SAECO AULIKA TOP

MACSAE198.T.0013

TAVOLA NR. 13 - ARTICOLO SAECO AULIKA TOP

## Model Machine

MACSAE198

SAECO AULIKA TOP

Web Pos. Foto Item - Replace by Description



Press - CTRL + CLICK go to item in a new window

Натисніть - Ctrl + права кнопка миші щоб відкрити запчастину в новому вікні













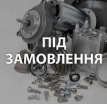

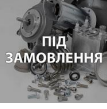











	1		<b>11035705</b>	ANT/L BASE DUMP BOX RYLO ASSY. AS.CAS.FONDI BASE RYLO VERN.ANT/L
	2		<b>9161.111</b>	MAGNET FOR FLOAT SUPERAUT. MAGNET FOR FLOAT SUPERAUT.
	3		<b>11035704</b>	ANT/L BASE REPOSITORY DRAWER RYLO CAS.RIPOSTIGLIO BASE RYLO VERN.ANT/L
	4		<b>421941302441</b>	ШУХЛЯДА ЛІВА, ЧОРНА ДЛЯ БАЗОВОЇ ПІДСТАВКИ TXO/BLK BASE REPOSITORY DRAWER RYLO
	5		<b>421941302421</b>	UNPAINT.BASE REPOSITORY DRAWERRYLO CAS.RIPOSTIGLIO BASE RYLO NER.D/VERN.
	6		<b>11021829</b>	ФІКСУЮЧИЙ НІС НИЖНІЙ ЧАСТИНИ КОРПУСУ (НІЖКИ) PHILIPS SAECO 9... BLACK/TRANSP.RIGID FOOT MYB9
	7		<b>11021769</b>	BLACK RIGID FOOT FIXING PIN MYB9 BLACK RIGID FOOT FIXING PIN MYB9
	8		<b>421946005111</b>	BLK STEEL BASE CASING V2 RYLOASSY. BLK STEEL BASE CASING V2 RYLO ASSY.
	9		<b>15003922</b>	MANUAL SAE SUP040R RYLO RI 17LANG. MANUAL SAE SUP040R RYLO RI 17LANG.
	10		<b>13001519</b>	PS-E INSERT FOR BOX BASE RYLO PS-E INSERT FOR BOX BASE RYLO
	11		<b>13001676</b>	HAVANA BOX V2 BASE RYLO HAVANA BOX V2 BASE RYLO
	12		<b>421944001181</b>	BLK BASE REAR PANEL RYLO BLK BASE REAR PANEL RYLO
	13		<b>12001622</b>	SCREW TCB TORX B 3,5X9,5 SCHEET NIK SCREW TCB TORX B 3,5X9,5 SCHEET NIK



## Model Machine

MACSAE198

SAECO AULIKA TOP

	14		<b>NV03.002</b>	CAP 3/4 "KAPSTO 800R 3/4" "CAP 3/4 "KAPSTO 800R 3/4""
	15	 ПІД ЗАМОВЛЕННЯ	<b>NV99.075</b>	GHIERA IN NYLON G3/4" 6 MM. "GHIERA IN NYLON G3/4" 6 MM.
	16	 ПІД ЗАМОВЛЕННЯ	<b>129912104</b>	SCREW TCBR TORX 20 4X10 PLAST.ZN-N SCREW TCBR TORX 20 4X10 PLAST.ZN-N
	17		<b>17001582</b>	НАДЛИШКОВИЙ КЛАПАН ВИСОКОГО ТИСКУ SAECO SS-7117001582 CONNECT.WATER SUPPLY RYLO RI ASSY.
	18		<b>11029701</b>	BLACK BASE REAR PANEL RYLO RI BLACK BASE REAR PANEL RYLO RI
	19	 ПІД ЗАМОВЛЕННЯ	<b>421941302531</b>	TXO/BLK BASE DUMP BOX RYLO ASSY. TXO/BLK BASE DUMP BOX RYLO ASSY.
	20	 ПІД ЗАМОВЛЕННЯ	<b>421941302451</b>	UNPAINT.BASE DUMP BOX RYLO ASSY. AS.CAS.FONDI BASE RYLO NER.D/VERN.
	21	 ПІД ЗАМОВЛЕННЯ	<b>11035703</b>	BLK/ G/ANT BASE RYLO ASSY. AS.BASE RYLO NER/ANT/L
	22	 ПІД ЗАМОВЛЕННЯ	<b>11035753</b>	BLK/G/ANT BASE RYLO ASSY. AS.BASE RYLO RI NER/ANT/L
	23	 ПІД ЗАМОВЛЕННЯ	<b>11034378</b>	BLK/TXO BASE RYLO RI ASSY. BLK/TXO BASE RYLO RI ASSY.
	24	 ПІД ЗАМОВЛЕННЯ	<b>421944010861</b>	BLK-TXO/BLK BASE RYLO ASSY. BLK-TXO/BLK BASE RYLO ASSY.
	25	 LIBERTY UKRAINE	<b>129914302</b>	SCREW TORX M4X10 TESTA D=8X1,5GALV SCREW TORX M4X10 TESTA D=8X1,5 GALV
	26	 ПІД ЗАМОВЛЕННЯ	<b>11036001</b>	BLK/L BASE RYLO K-TOP RI ASSY. BLK/L BASE RYLO K-TOP RI ASSY.
	27	 ПІД ЗАМОВЛЕННЯ	<b>11035262</b>	BLK-BLK BASE RYLO ASSY. AS.BASE RYLO/O NER-NER



## Model Machine

MACSAE198

SAECO AULIKA TOP























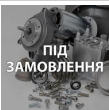

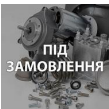

MACSAE198.T.0014

TAVOLA NR. 14 - ARTICOLO SAECO AULIKA TOP

## Model Machine

MACSAE198

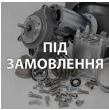



























SAECO AULIKA TOP

Web	Pos.	Foto	Item - Replace by	Description
				<i>Press - CTRL + CLICK go to item in a new window Натисніть - Ctrl + права кнопка миші щоб відкрити запчастину в новому вікні</i>
	1		11021334	BLK COUNTERPISTON SEAL DE=11 DI=8 SP=1,4 <i>BLK COUNTERPISTON SEAL DE=11 DI=8 SP=1,4</i>
	2		11003789	BLACK COFF.OUTLET SLEEVE BREWUNIT ROYAL <i>BLACK COFF.OUTLET SLEEVE BREW UNIT ROYAL,AULIKA MAGIC SAECO</i>
	3		9161.222	SS.CONICAL SPRING <i>MOLLA CONICA</i>
	4		421944034451	BOROSILICATE SPHERE D.5 MM <i>BOROSILICATE SPHERE D.5</i>
	5		12002170	SCREW TCB TORX 10 3X16 PLAST SS <i>VITE TCB 3X16 TORX 10 PLAST.INOX</i>
	6		147472650	PIN BLACK FOR PERCOLATOR <i>PIN BLACK FOR PERCOLATOR</i>
	7		NF11.067	BRASS INSERT FOR PERCOLATOR LOCKING PIN <i>BRASS INSERT FOR PERCOLATOR LOCKING PIN</i>
	8		140324461	OR ORM 0060-20 TERMOIL <i>OR ORM 0060-20 IN TERMOIL</i>
	9		11003796	BLACK BREW UNIT COUNTERPISTONM5000 <i>BLACK BREW UNIT COUNTERPISTON M5000</i>
	10		NM01.044	OR ORM 0320-40 SILICONE PTFE/FDA <i>OR ORM 0320-40 SILICONE PTFE</i>
	11		9160.075	PERCOLATOR DE=35,8 ELFO ASSY. <i>PERCOLATOR DE=35,8 ELFO ASSY.</i>
	12		11003077	BLK BREW UNIT INTEGRAL PISTON8GR.ASSY. <i>BLK BREW UNIT INTEGRAL PISTON 8GR.ASSY.</i>
	13		9161.198	SS.8GR.BREW UNIT PISTON SPRING <i>SS.8GR.BREW UNIT PISTON SPRING</i>

## Model Machine

MACSAE198



















SAECO AULIKA TOP

	14		<b>9161.191</b>	WHITE 8GR.-12GR.BREW UNIT PISTON BUSH <i>BOCCOLA X PISTONE NEUTRO</i>
	15		<b>227470150</b>	PIN BLACK ASS.FOR PERCOLATOR <i>PIN BLACK ASS.FOR PERCOLATOR</i>
	16		<b>11023086</b>	BLK 8GR.BREW UNIT NTEGR.PISTONGEN.ASSY. <i>BLK 8GR.BREW UNIT NTEGR.PISTON GEN.ASSY.</i>
	17		<b>NM02.018</b>	OR ORM 0090-25 TERMOIL <i>OR ORM 0090-25 TERMOIL</i>
	18		<b>11001556</b>	SS BREW UNIT SPRING H=49 SMART <i>SS BREW UNIT SPRING H=49 SMART</i>
	19		<b>421944014611</b>	BLK COF.CONTAIN.BREW UNIT V2 M5000 ASSY. <i>BLK COF.CONTAIN.BREW UNIT V2 M5000 ASSY.</i>
	20		<b>129912521</b>	SCREW TCBR TORX 10 3,5X14 PLAST.SS <i>SCREW TCBR TORX 10 3,5X14 PLAST.SS</i>
	21		<b>11003078</b>	BLACK CONNECTING ROD BREW UNIT8GR. <i>BLACK CONNECTING ROD BREW UNIT 8GR.</i>
	22		<b>11003795</b>	BLACK HOPPER COFF.BREW UNIT S/SCR.M5000 <i>BLACK HOPPER COFF.BREW UNIT S/SCR.M5000</i>
	23		<b>9161.046</b>	ПРУЖИНА ВОРОНКИ ЗАВАРОЧНОГО БЛОКА ДЛЯ КОФЕМАШИН PHILIPS ... <i>MOLLA X RASATORE GRUPPO</i>
	24		<b>11004570</b>	BLACK BREW UNIT COFFEE CONT.P124 ASSY. <i>AS.CONT.CAF.GRUP.8G.P124 NER.</i>
	25		<b>9161.064.050</b>	BLACK WATER INLET SLEEVE BREWUNIT ROYAL <i>BLACK WATER INLET SLEEVE BREW UNIT ROYAL</i>
	26		<b>NM02.007</b>	OR 2025 IN TERMOIL <i>OR 2025 TERMOIL</i>
	27		<b>421941158532</b>	BLACK BREW UNIT REAR PLATE V2M5000 <i>BLACK BREW UNIT REAR PLATE V2 M5000</i>

## Model Machine

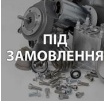
MACSAE198

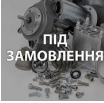
SAECO AULIKA TOP

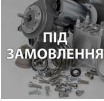
	28		12000550	CAMOP13 TCB TORX 10 3X25 PLAST.SS SCREW TCB TORX 10 3X25 PLAST.SS
	29		9161.094.050	BLACK BREW UNIT DRILLED BLOCK BLACK BREW UNIT DRILLED BLOCK
	30		9161.066.050	BLACK BREW UNIT ELBOW SHAFT M5000 BLACK BREW UNIT ELBOW SHAFT M5000
	31		11004161	BLACK SCRAPER FOR BREW UNIT M5000 BLACK SCRAPER FOR BREW UNIT M5000
	32		11003793	BLACK BREW UNIT FRONT PLATE M5000 BLACK BREW UNIT FRONT PLATE M5000
	33		11004114	BLACK BREW UNIT COUPLING PLATE BLACK BREW UNIT COUPLING PLATE
	34		9161.045	SS BREW UNIT HANDGRIP SPRING M5000 MOLLA X IMPUGNATURA GRUPPO
	35		11003791	BLACK BREW UNIT HANDGRIP M5000 BLACK BREW UNIT HANDGRIP M5000
	36		11003800	BLACK BREW UNIT BLACK BREW UNIT MAGIC/ROYAL
	37		12000897	SCREW TCB TORX 10 3,5X20 PLAST.SS SCREW TCB TORX 10 3,5X20 PLAST.SS

## Model Machine

MACSAE198

SAECO AULIKA TOP

MACSAE198.T.0015

TAVOLA NR. 15 - ARTICOLO SAECO AULIKA TOP

## Model Machine

MACSAE198

SAECO AULIKA TOP

Web Pos. Foto Item - Replace by Description



*Press - CTRL + CLICK go to item in a new window  
Натисніть - Ctrl + права кнопка миші щоб відкрити запчастину в новому вікні*



1

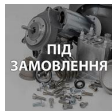

21002350

VE KIT BOX PAYM. SYS. AULIKA TOP HSC  
VE KIT BOX PAYM. SYS. AULIKA TOP HSC



2

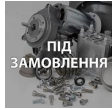

10005004

VE CABINET AULIKA-ROYAL-AMBRABLK-SIL  
VE CABINET AULIKA-ROYAL-AMBRABLK-SIL



3



10005145

FRIDGE FR7L BR9D R600A  
FRIDGE FR7L BR9D R600A



4

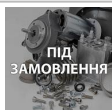

21001820

ACC PR MANTENITORE 100/240V 50-60HZ BLK  
ACC PR MANTENITORE 100/240V 50-60HZ BLK