

Model Machine

MACSAE314

KABOBAPKA OCS AULIKA OFFICE V2 BLK 2 230/50SCH +KIT (10005233)

MACSAE314.T.0001



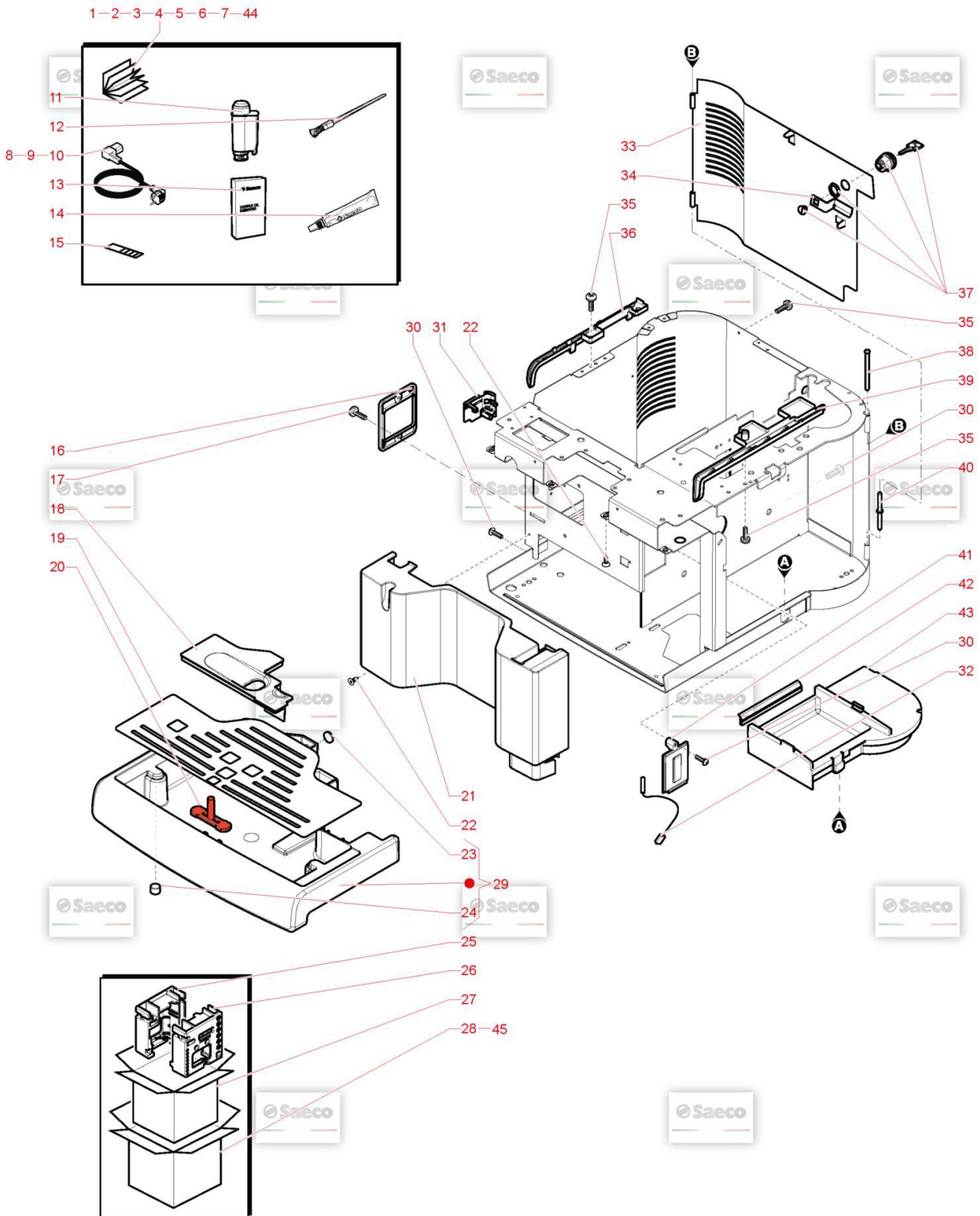









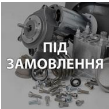

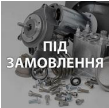

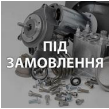

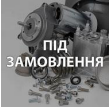

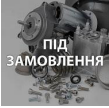

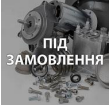

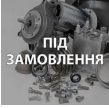
TAVOLA NR. 1 - ARTICOLO KABOBAPKA OCS AULIKA OFFICE V2 BLK 2 230/50SCH +KIT (10005233

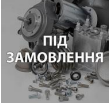

Model Machine

MACSAE314



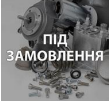











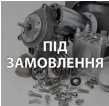





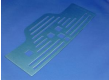





КАБОВАРКА OCS AULIKA OFFICE V2 BLK 2 230/50SCH +KIT (10005233)

Web	Pos.	Foto	Item - Replace by	Description
				<i>Press - CTRL + CLICK go to item in a new window Натисніть - Ctrl + права кнопка миші щоб відкрити запчастину в новому вікні</i>
	1		15004965	MANUAL SAE OFFICE RYLO/O V2 GB MANUAL SAE OFFICE RYLO/O V2 GB
	2		15004966	MANUAL SAE OFFICE RYLO/O DE MANUAL SAE OFFICE RYLO/O DE
	3		15004967	MANUAL SAE OFFICE RYLO/O V2 FR MANUAL SAE OFFICE RYLO/O V2 FR
	4		15004968	MANUAL SAE OFFICE RYLO/O V2 ES MANUAL SAE OFFICE RYLO/O V2 ES
	5		15004969	MANUAL SAE OFFICE RYLO/O V2 IT MANUAL SAE OFFICE RYLO/O V2 IT
	6		15005190	MANUAL SAE OFFICE RYLO/O KOR MANUAL SAE OFFICE RYLO/O KOR
	7		15004972	MANUAL SAE OFFICE RYLO/O V2 PT MANUAL SAE OFFICE RYLO/O V2 PT
	8		183911050	ЧОРНИЙ КАБЕЛЬ SCHUKO L=1200 SAECO BLACK POWER CABLE SCHUKO L=1200
	9		11001985	BLACK POWER CABLE KOREA L=1200 BLACK POWER CABLE KOREA L=1200
	10		17800019	BLACK POWER CABLE BRAZIL L=1200 BLACK POWER CABLE BRAZIL L=1200
	12		21002660	ACC BRITA WATER FILTER 1UNIT (1011623) ACC BRITA WATER FILTER 1UNIT (1011623)
	13		21002663	ACC COF.OIL REMOVER 1UNIT CORE+W/D ACC COF.OIL REMOVER 1UNIT CORE+W/D

Model Machine

MACSAE314

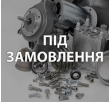









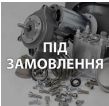

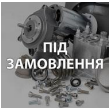













KABOBAPKA OCS AULIKA OFFICE V2 BLK 2 230/50SCH +KIT (10005233)

	14		421946017941	KLUBERLUB NH1 11-222 TUBE 5GR. <i>PSA KLUBER TRIBOSTAR SIL 2 TUBE 5GR.</i>
	15		0301.961	STICKER FOR WATER HARDNESS TEST <i>TEST DUREZZA ACQUA</i>
	16	 ПІД ЗАМОВЛЕННЯ	421944062731	BLK CONNECTOR LID <i>BLK CONNECTOR LID</i>
	17	 ПІД ЗАМОВЛЕННЯ	U143.015	PANELVIT TCB 3,0X12 TORX BLACK <i>PANELVIT TCB 3,0X12 TORX BLACK</i>
	18		17000982	BLACK DRIP TRAY COVER RYL <i>BLACK DRIP TRAY COVER RYL</i>
	19		11029899	SB/SS DRIP TRAY GRATE RYL/T <i>SB/SS DRIP TRAY GRATE RYL</i>
	20		17000991	RED FLOAT V2 FOR DRIP TRAY RYL <i>RED FLOAT V2 FOR DRIP TRAY RYL</i>
	21	 ПІД ЗАМОВЛЕННЯ	11034960	UNPAINT.BLK.FRONT CASING COVERRYLO/T <i>COP.ANT.CARC.RYLO/T NER.D/VERN.</i>
	22		129535721	SCREW TSP TORX 10 AB 3,5X9,5 SHEET SS <i>SCREW TSP TORX 10 AB 3,5X9,5 SHEET SS</i>
	23		9991.093	MAGNET D=9,5 X H=1,5 <i>MAGNETE D.9,5 X 1,5</i>
	24		9161.111	MAGNET FOR FLOAT SUPERAUT. <i>MAGNET FOR FLOAT SUPERAUT.</i>
	25	 ПІД ЗАМОВЛЕННЯ	13001518	PS-E LEFT INSERT FOR BOX RYLO <i>PS-E LEFT INSERT FOR BOX RYLO</i>
	26	 ПІД ЗАМОВЛЕННЯ	13001517	PS-E RIGHT INSERT FOR BOX RYLO <i>PS-E RIGHT INSERT FOR BOX RYLO</i>
	27	 ПІД ЗАМОВЛЕННЯ	13001327	HAVANA BOX RYLO SAE AULIKA <i>HAVANA BOX RYLO SAE AULIKA</i>

Model Machine

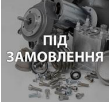
MACSAE314

КАВОВАРКА OCS AULIKA OFFICE V2 BLK 2 230/50SCH +KIT (10005233)

	28		13001328	WHITE EXTERNAL BOX RYLO SAE <i>WHITE EXTERNAL BOX RYLO SAE</i>
	29		11031201	UNPAINTED DRIP TRAY RYL ASSY. <i>AS.VASCA REC.ACQ.RYL NER.D/VERN.</i>
	30		12000450	SCREW TCBR TORX 10 3,5X12 PLAST.ZN-N <i>SCREW TCBR TORX 10 3,5X12 PLAST.ZN-N</i>
	31		17000779	BLACK STEAM TUBE PROTECTION RYL <i>BLACK STEAM TUBE PROTECTION RYL</i>
	32		17800442	2POLES CONNECT.SENSOR REED DUMP BOX CST <i>2POLES CONNECT.SENSOR REED DUMP BOX CST</i>
	33		11025819	BLACK CASING DOOR RYL ASSY. <i>BLACK CASING DOOR RYL ASSY.</i>
	34		17001988	STEEL CASING DOOR LOCK BRACKETRYLO <i>STEEL CASING DOOR LOCK BRACKET RYLO</i>
	35		12001622	SCREW TCB TORX B 3,5X9,5 SCHEET NIK <i>SCREW TCB TORX B 3,5X9,5 SCHEET NIK</i>
	36		17002110	BLACK CASING LEFT CLOSING INSERT RYL/H <i>BLACK CASING LEFT CLOSING INSERT RYL/H</i>
	37		12001902	LOCK MERONI 337 <i>LOCK MERONI 337</i>
	38		0301.019	NIK/BRASS PIN FOR DOOR SUPERAUT. <i>NIK/BRASS PIN FOR DOOR SUPERAUT.</i>
	39		11031307	BLACK CASING RIGHT CLOSING INSERT RYL <i>BLACK CASING RIGHT CLOSING INSERT RYL</i>
	40		0301.020	NIK/BRASS PIN FOR DOOR SUPERAUT. <i>NIK/BRASS PIN FOR DOOR SUPERAUT.</i>
	41		17000240	GREY MOUNTING PLATE INSERT RYL <i>GREY MOUNTING PLATE INSERT RYL</i>

Model Machine

MACSAE314

KABOBAPKA OCS AULIKA OFFICE V2 BLK 2 230/50SCH +KIT (10005233)



42



9161.140

SEAL FOR UNIT PLATE

GUARNIZIONE X PIASTRA GRUPPO



43



0301.041.150

GREY BREW UNIT SUPPORT PLATE ROYAL

PIASTRA SUPPORTO GRUPPO GRIGIO

Model Machine

MACSAE314

KABOBAPKA OCS AULIKA OFFICE V2 BLK 2 230/50SCH +KIT (10005233)

MACSAE314.T.0002

TAVOLA NR. 2 - ARTICOLO KABOBAPKA OCS AULIKA OFFICE V2 BLK 2 230/50SCH +KIT (10005233

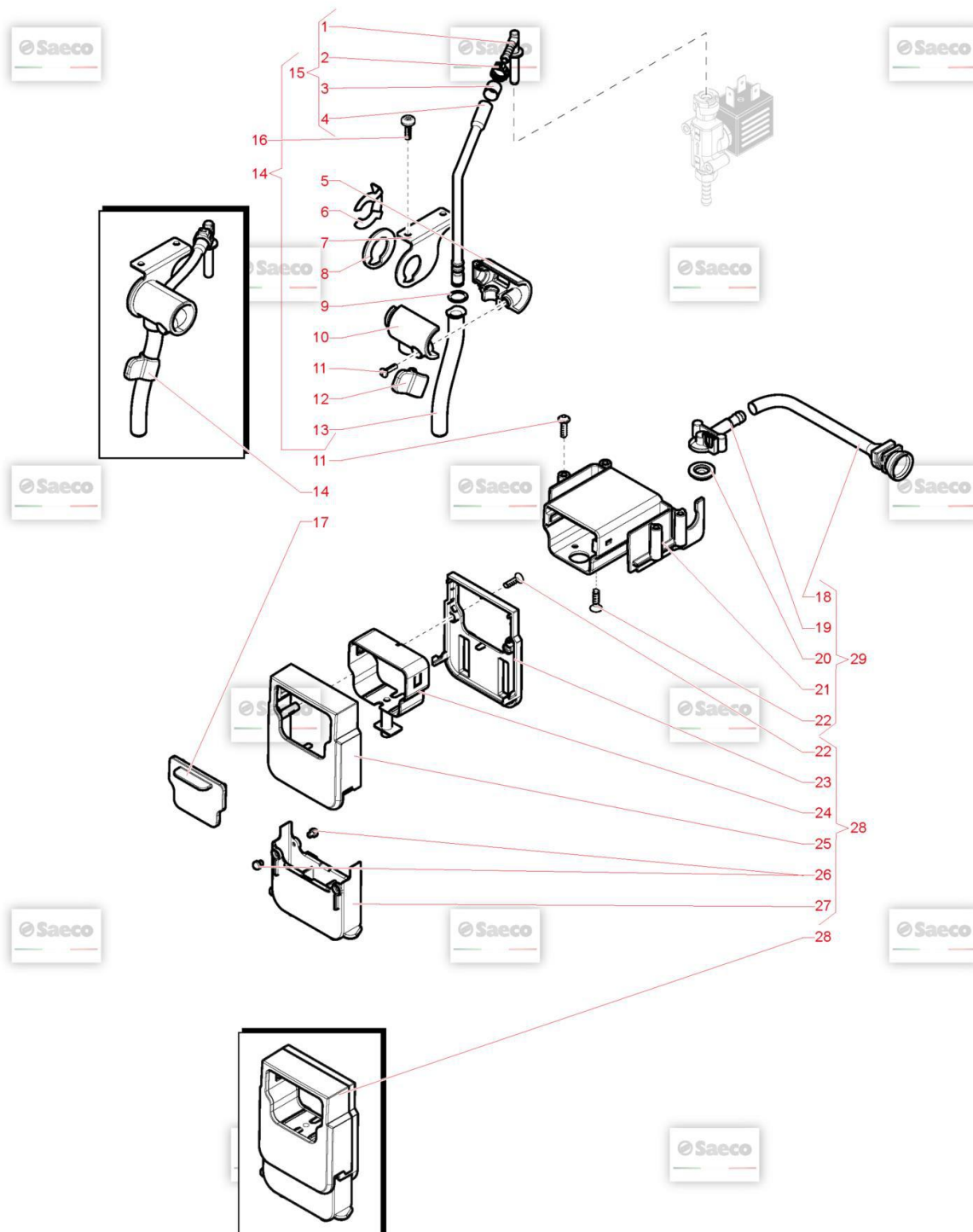

Model Machine

MACSAE314

КАВОВАРКА OCS AULIKA OFFICE V2 BLK 2 230/50SCH +KIT (10005233)

Web Pos. Foto Item - Replace by Description



Press - CTRL + CLICK go to item in a new window





























Натисніть - Ctrl + права кнопка миші щоб відкрити запчастину в новому вікні

	1		17002197	BLACK CAPPUCIN/STEAM TUBE CONNECT.V4 RYL <i>BLACK CAPPUCIN/STEAM TUBE CONNECT.V4 RYL</i>
	2		12000892	ЗАЖИМ D.9,5 16700004 <i>OETIKER CLAMP D=9,5 16700004 (L250)</i>
	3		11025683	BLACK TUBE DI=9,5 SP=0,30 L=10 <i>BLACK TUBE DI=9,5 SP=0,30 L=10</i>
	4		11022989	BLACK SILIC.STEAM DISPENSER TUBE MDS <i>TUBO EROG.VAP.MDS SILIC.NER.</i>
	5		17000672	BLACK REAR STEAM TUBE SUPPORTRYL <i>BLACK REAR STEAM TUBE SUPPORT RYL</i>
	6		NF11.084	PHOSPH/STEEL FOLK SPRING <i>PHOSPH/STEEL FOLK SPRING</i>
	7		17000815	STEEL STEAM TUBE SUPPORT BRACKET RYL <i>STEEL STEAM TUBE SUPPORT PLATE RYL</i>
	8		11001624	BLACK STEAM TUBE WASHER P0049 <i>BLACK STEAM TUBE WASHER P0049</i>
	9		140321961	ПРОКЛАДКА O-RING ДЛЯ КАВОМАШИНИ SAECO 2031 TERMOIL <i>OR 2031 IN TERMOIL</i>
	10		17001437	BLACK FRONT STEAM TUBE SUPPORTRYL <i>BLACK FRONT STEAM TUBE SUPPORT RYL</i>
	11		12000450	SCREW TCBR TORX 10 3,5X12 PLAST.ZN-N <i>SCREW TCBR TORX 10 3,5X12 PLAST.ZN-N</i>
	12		17001574	BLACK STEAM TUBE HANDGRIP RYLO <i>BLACK STEAM TUBE HANDGRIP RYLO</i>
	13		11025760	TF/CHROM.STEAM TUBE RYL <i>TF/CHROM.STEAM TUBE RYL</i>

Model Machine

MACSAE314

КАВОВАРКА OCS AULIKA OFFICE V2 BLK 2 230/50SCH +KIT (10005233)

	14		11031416	ХРОМОВАНА ТРУБКА ДЛЯ ВОДИ/ПАРУ V3 <i>TF/CHROM.STEAM TUBE V3 RYL/T ASSY.</i>
	15		20007030	BLACK OUTPUT STEAM TUBE KIT RYL <i>BLACK OUTPUT STEAM TUBE KIT RYL</i>
	16		12001622	SCREW TCB TORX B 3,5X9,5 SCHEET NIK <i>SCREW TCB TORX B 3,5X9,5 SCHEET NIK</i>
	17		11031102	ФРОНТАЛЬНА КРИШКА ДІСПЕНСЕРУ <i>CRC FRONT COFFEE DISPENSER COVER RYL/H</i>
	18		17000614	BLACK DISPENSER COFF.INLET CONNECT.RYL <i>BLACK DISPENSER COFF.INLET CONNECT.RYL</i>
	19		17000616	BLACK COFFEE DISPENSER TUBE RYL <i>BLACK COFFEE DISPENSER TUBE RYL</i>
	20		17000337	BLACK SEAL FOR COFFEE DISPENSER RYL <i>BLACK SEAL FOR COFFEE DISPENSER RYL</i>
	21		17000257	BLACK.COFFEE DISPENSER SUPPORTRYL <i>BLACK.COFFEE DISPENSER SUPPORT RYL</i>
	22		12000895	SCREW TSP TORX 10 3X10 PLAST.SS <i>SCREW TSP TORX 10 3X10 PLAST.SS</i>
	23		17000248	BLACK REAR COVER COFFEE DISPENSER RYL <i>BLACK REAR COVER COFFEE DISPENSER RYL</i>
	24		17000251	BLACK INNER BODY COFFEE DISPENS.RYL <i>BLACK INNER BODY COFFEE DISPENS.RYL</i>
	25		11030102	CRC FRONT COF.DISPENSER COVERRYL <i>CRC FRONT COF.DISPENSER COVER RYL</i>
	26		11013085	WHITE COFFEE DISPENSER SLIDERMYB9 <i>WHITE COFFEE DISPENSER SLIDER MYB9</i>
	27		17000246	ЧОРНА ЗАГЛУШКА ЧАСТИНИ КАВОВОГО ДІСПЕНСОРА <i>BLACK EXT.MOBILE PART COF.DISPENSER RYL</i>

Model Machine

MACSAE314

КАВОВАРКА OCS AULIKA OFFICE V2 BLK 2 230/50SCH +KIT (10005233)



28

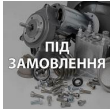

11030101

CRC COFFEE DISPENSER RYL ASSY.
AS.EROG.CAF.RYL CRC



29

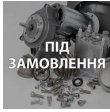

11031103

BLK COFFEE DISPENSER SUPPORT RYL/H ASSY.
BLK COFFEE DISPENSER SUPPORT RYL/H ASSY.

Model Machine

MACSAE314

KABOBAPKA OCS AULIKA OFFICE V2 BLK 2 230/50SCH +KIT (10005233)

MACSAE314.T.0003

TAVOLA NR. 3 - ARTICOLO KABOBAPKA OCS AULIKA OFFICE V2 BLK 2 230/50SCH +KIT (10005233

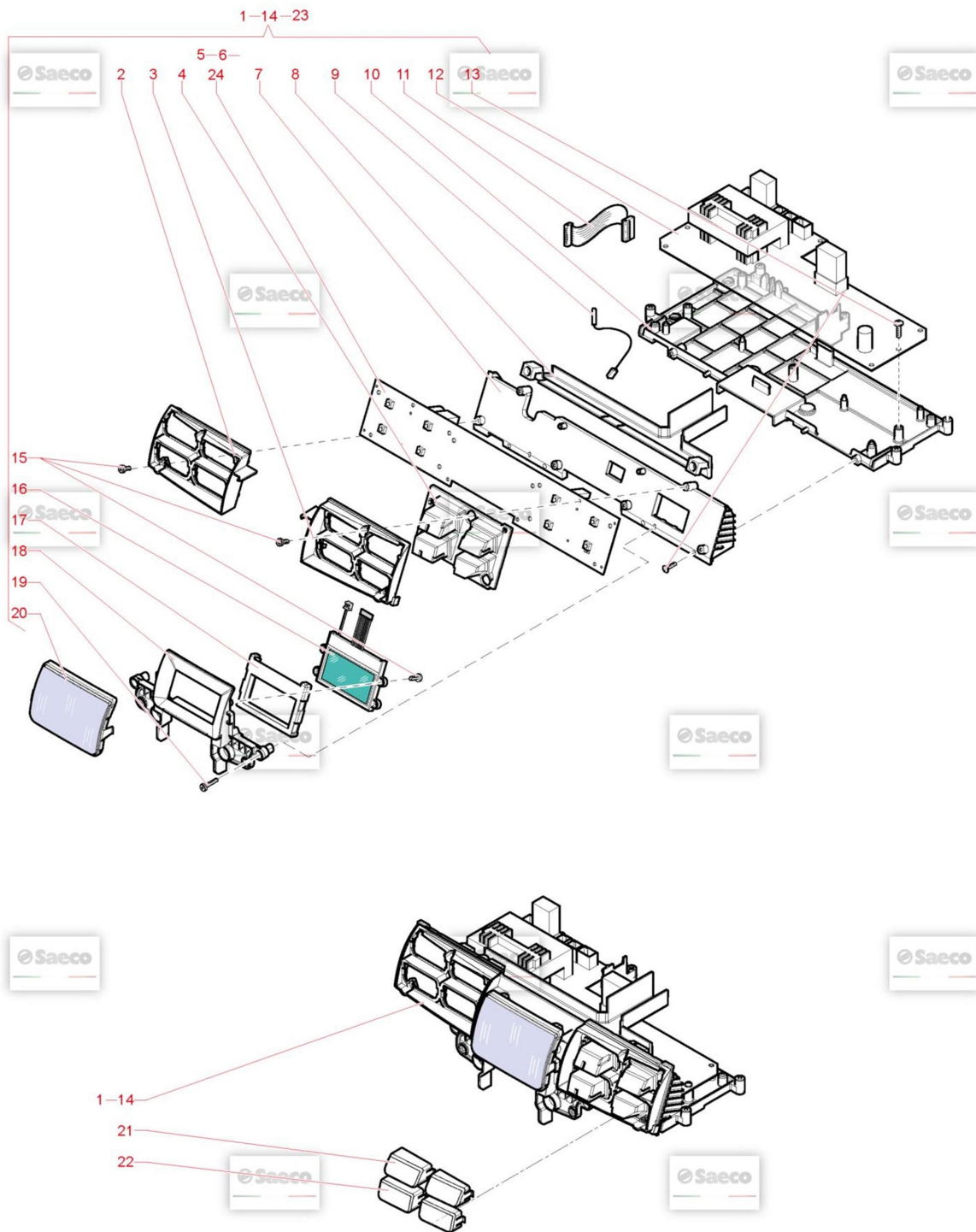

Model Machine

MACSAE314

КАВОВАРКА OCS AULIKA OFFICE V2 BLK 2 230/50SCH +KIT (10005233)

Web Pos. Foto Item - Replace by Description



Press - CTRL + CLICK go to item in a new window











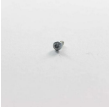



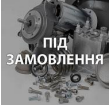

Натисніть - Ctrl + права кнопка миші щоб відкрити запчастину в новому вікні

	2		17000831	BLACK LEFT TOUCH PANEL SUPPORTRYLO <i>BLACK LEFT TOUCH PANEL SUPPORT RYLO</i>
	3		17000830	BLACK RIGHT TOUCH PANEL SUPPORT RYLO <i>BLACK RIGHT TOUCH PANEL SUPPORT RYLO</i>
	4		17000484	TRANSP.RIGHT TOUCH PANEL RYLO <i>TRANSP.RIGHT TOUCH PANEL RYLO</i>
	5		11036762	ASS.CPU+SW AULIKA 2018 B2B <i>ASS.CPU+SW AULIKA 2018 B2B</i>
	6		11000175	ASS.CPU+SW AULIKA K-OFFICE V2 <i>ASS.CPU+SW AULIKA K-OFFICE V2</i>
	7		421941277592	BLK CPU BOARD SUPPORT V2 RYL <i>BLK CPU BOARD SUPPORT V2 RYL</i>
	8		17001152	POWER BOARD PROTECTION RYL <i>POWER BOARD PROTECTION RYL</i>
	9		17800442	2POLES CONNECT.SENSOR REED DUMP BOX CST <i>2POLES CONNECT.SENSOR REED DUMP BOX CST</i>
	10		17000275	BLACK PWR BOARD SUPPORT RYL <i>BLACK PWR BOARD SUPPORT RYL</i>
	11		63A006500	14P.FLAT CABLE CPU-PWR EVO RYL <i>14P.FLAT CABLE CPU-PWR V2 RYL</i>
	12		421941307761	PWR BOARD RYL/RYLO V2 230V <i>SCHEDA POWER RYL/RYLO V2</i>
	13		12000450	SCREW TCBR TORX 10 3,5X12 PLAST.ZN-N <i>SCREW TCBR TORX 10 3,5X12 PLAST.ZN-N</i>
	14		11000182	AS.PART EL.RYL/O 220V <i>AS.PART EL.RYL/O 220V</i>

Model Machine

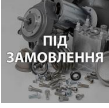
MACSAE314

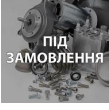
КАВОВАРКА OCS AULIKA OFFICE V2 BLK 2 230/50SCH +KIT (10005233)

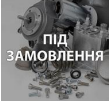
	15		129913202	SCREW TCB TORX 10 3X8 PLAST.ZN-B SCREW TCB TORX 10 3X8 PLAST.ZN-B
	16		12001779	WHITE DISPLAY 160X80 WHITE DISPLAY 160X80 0355DP RYL
	17		17000271	BLACK DISPLAY SEAL RYL BLACK DISPLAY SEAL RYL
	18		17000259	BLACK DISPLAY INSERT RYL BLACK DISPLAY INSERT RYL
	19	 ПІД ЗАМОВЛЕННЯ	129914002	SCREW TCB TORX 10 3,5X16 PLAST.ZN-B SCREW TCB TORX 10 3,5X16 PLAST.ZN-B
	20		17000269	СКЛО ДИСПЛЕЯ PHILIPS SAECO 996530068575 TRANSP.GLASS FOR DISPLAY RYL
	21	 ПІД ЗАМОВЛЕННЯ	11035951	BLK TAMP. RIGHT UPP.T.PAN.COV.RYL/O V2 COP.TAST.SUP.DX RYLO/O NER.TAMP.V2
	22	 ПІД ЗАМОВЛЕННЯ	11035952	BLK TAMP. RIGHT LOW.T.PAN.COV.RYL/O V2 COP.TAST.INF.DX RYLO/O NER.TAMP.V2
	24	 ПІД ЗАМОВЛЕННЯ	264141	CPU+FW_AULIKA_V2 LOGO ROYAL

Model Machine

MACSAE314

KABOBAPKA OCS AULIKA OFFICE V2 BLK 2 230/50SCH +KIT (10005233)

MACSAE314.T.0004



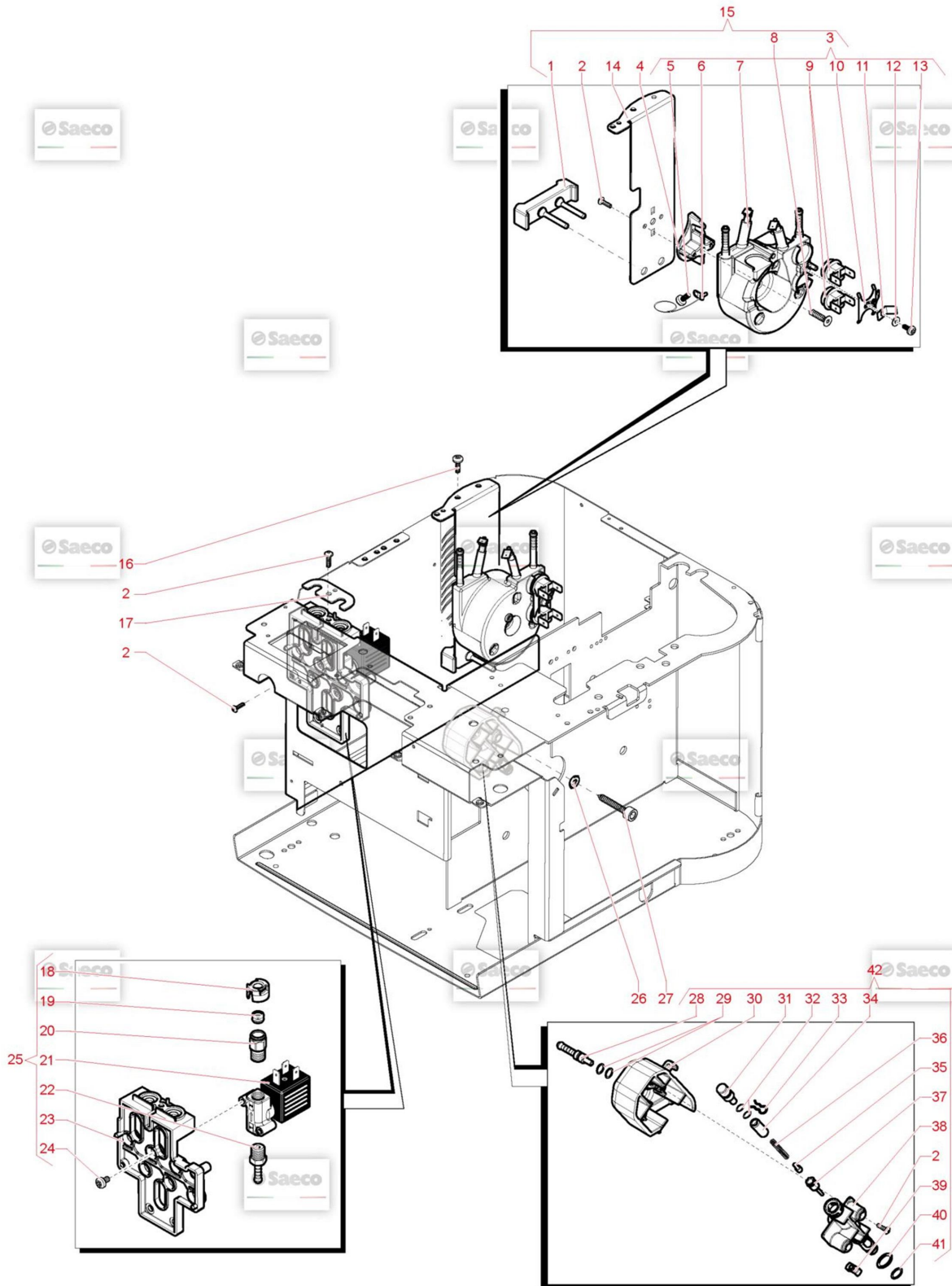









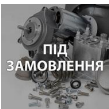











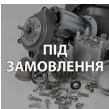

TAVOLA NR. 4 - ARTICOLO KABOBAPKA OCS AULIKA OFFICE V2 BLK 2 230/50SCH +KIT (10005233

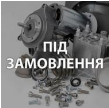

Model Machine

MACSAE314











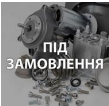

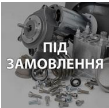













КАВОВАРКА OCS AULIKA OFFICE V2 BLK 2 230/50SCH +KIT (10005233)

Web	Pos.	Foto	Item - Replace by	Description
				<i>Press - CTRL + CLICK go to item in a new window Натисніть - Ctrl + права кнопка миші щоб відкрити запчастину в новому вікні</i>
	1		17000471	BLACK BOILER ANTIVIBRATION RYL <i>BLACK BOILER ANTIVIBRATION RYL</i>
	2		12000450	SCREW TCBR TORX 10 3,5X12 PLAST.ZN-N <i>SCREW TCBR TORX 10 3,5X12 PLAST.ZN-N</i>
	3		421941229822	SLIM T.CHAUD.V2 C2 T190-190 1300W 230 AS <i>SLIM T.CHAUD.V2 C2 T190-190 1300W 230 AS</i>
	4		421944057621	NEU SLIM TUB.BOILERS SUPPORT V2 MYB9 <i>NEU SLIM TUB.BOILERS SUPPORT V2 MYB9</i>
	5		129573402	SCREW TAPT M4X10 DIN 7985 GALV <i>SCREW TAPT M4X10 DIN 7985 GALV</i>
	6		190800100	ТЕМПЕРАТУРНИЙ СЕНСОР NTC UL L=280MM <i>TEMPERATURE SENSOR NTC UL L=280MM</i>
	7		421944024121	БОЙЛЕР И ТЭН ДЛЯ КОФЕВАРКИ (КОФЕМАШИНЫ) XS4 1300W 230V ASS... <i>TUB.BOILER XS4 1300W 230V ASSY.</i>
	8		12001369	SCREW TSP TORX 10 5X35 PLAST.SS <i>SCREW TSP TORX 10 5X35 PLAST.SS</i>
	9		12001033	ТЕРМОСТАТ 190°С БОЙЛЕРА ДЛЯ КОФЕВАРОК PHILIPS SAECO 12001033 <i>THERMOSTAT ONE SHOT 190°</i>
	10		11001751	TUB.BOILER V3 UPPER THERM.FIXING SPRING <i>TUB.BOILER V3 UPPER THERM.FIXING SPRING</i>
	11		124390520	BRASS BENT FASTON 45° 6,3X0,8 <i>BRASS BENT FASTON 45° 6,3X0,8</i>
	12		128310402	GALV.WASHER UNI 8842 A4 <i>GALV.WASHER UNI 8842 A4</i>
	13		12001715	SCREW TCB TORX 20 M4X8 AUTOFORMING ZN-B <i>SCREW TCB TORX 20 M4X8 AUTOFORMING ZN-B</i>

Model Machine

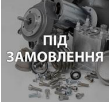
MACSAE314













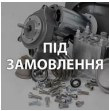











КАВОВАРКА OCS AULIKA OFFICE V2 BLK 2 230/50SCH +KIT (10005233)

	14		17000163	STEEL COFFEE TUBOL.BOILER SUPPORT RYL/T <i>STEEL COFFEE TUBOL.BOILER SUPPORT RYL</i>
	15		11035974	COFFEE TUB.BOILER 230V RYL/P ASSY. <i>COFFEE TUB.BOILER 230V RYL/P ASSY.</i>
	16		12001622	SCREW TCB TORX B 3,5X9,5 SCHEET NIK <i>SCREW TCB TORX B 3,5X9,5 SCHEET NIK</i>
	17		17000428	STEEL CONNECTORS FIXING PLATERYL <i>STEEL CONNECTORS FIXING PLATE RYL</i>
	18		17001178	BLK EV 1/8"GAS.CONNECTOR V2 INSERT RYL <i>BLK EV 1/8 GAS.CONNECTOR V2 INSERT RYL</i>
	19		17001909	RED EV CONNECTOR 1/8"GAS SEALV2 RYL <i>RED EV CONNECTOR 1/8 GAS SEAL V2 RYL</i>
	20		11027334	З'ЄДНАННЯ 1/8"GAS V2 RYL <i>TEA/BRASS ELECTROV.CONNECT1/8"GAS V2 RYL</i>
	21		17001262	LFBRASS 2W.EV 21JN1R4V20-X031 <i>LFBRASS 2W.EV 21JN1RRV20-X005+LBV05024CU</i>
	22		11006304	TEA/BRASS CONNECTOR FOR ALUM.BOILER <i>TEA/BRASS CONNECTOR FOR ALUM.BOILER</i>
	23		17000168	BLACK ELECTROV/CONNECTOR SUPP.RYL <i>BLACK ELECTROV/CONNECTOR SUPP.RYL</i>
	24		U043.012	SCREW TCB TORX 20 M4X6 ZN-B <i>VITE TCBC M4,0X6 UNI 7687 Z</i>
	25		11035181	TEA/BRASS ELECTROV.V4 RYL/H 24V ASSY. <i>AS.ELETTROVALVOLE V4 RYL/H OT/TEA 24V</i>
	26		128310521	WASHER UNI 8842 A5 SS <i>WASHER UNI 8842 A5 SS</i>
	27		11003555	GALVANIZED SELF-TAPPING SCREW4,8X32 <i>GALVANIZED SELF-TAPPING SCREW 4,8X32</i>

Model Machine

MACSAE314

KABOBAPKA OCS AULIKA OFFICE V2 BLK 2 230/50SCH +KIT (10005233)

	28		11000750	TEA/BRASS CONNECTOR FOR SILICONE TUBE <i>TEA/BRASS CONNECTOR FOR SILICONE TUBE</i>
	29	 ПІД ЗАМОВЛЕННЯ	140328059	OR 2015 SILICONE PTFE/FDA <i>OR 2015 SILICONE PTFE/FDA</i>
	30		17000156	BLACK HOT WATER PIN SUPPORT RYL <i>BLACK HOT WATER PIN SUPPORT RYL</i>
	31		11026413	TEA/BRASS HOT WATER PIN PLUG RYL <i>TEA/BRASS HOT WATER PIN PLUG RYL</i>
	32		140326662	OR ORM 0040-20 SILICONE <i>OR METRIC 0040-20 IN SILICONE</i>
	33		9011.144	SS FORK FOR TUBE D=4 <i>FORCELLA X TUBO D.4</i>
	34		11009012	TEA/BRASS BOILER PIN BUSH <i>TEA/BRASS BOILER PIN BUSH</i>
	35		11009013	TEA/BRASS PIN FOR PISTON L=10 <i>TEA/BRASS PIN FOR PISTON L=10</i>
	36		9011.132	SS SPRING FOR PIN <i>MOLLA X SPILLO</i>
	37		11009019	TEA/BRASS PISTON L=20,9 ASSY. <i>TEA/BRASS PISTON L=20,9 ASSY.</i>
	38		9161.434	HOT WATER PIN <i>PERNO CALDAIA MAGIC,ROYAL SAECO</i>
	39		11005099	NATURAL CURSOR V2 FOR BOILER P119 <i>NATURAL CURSOR V2 FOR BOILER P119</i>
	40		NM01.035	OR ORM 0090-20 SILICONE <i>OR ORM 0090-20 SILICONE</i>

Model Machine

MACSAE314

КАВОВАРКА OCS AULIKA OFFICE V2 BLK 2 230/50SCH +KIT (10005233)



41

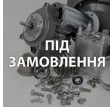

NM01.057

OR ORM 0050-20 IN SILICONE

OR ORM 0050-20 IN SILICONE



42



11025744

TEA/BRASS HOT WATER PIN RYL ASSY.

TEA/BRASS HOT WATER PIN RYL ASSY.

Model Machine

MACSAE314

KABOBAPKA OCS AULIKA OFFICE V2 BLK 2 230/50SCH +KIT (10005233)

MACSAE314.T.0005

TAVOLA NR. 5 - ARTICOLO KABOBAPKA OCS AULIKA OFFICE V2 BLK 2 230/50SCH +KIT (10005233

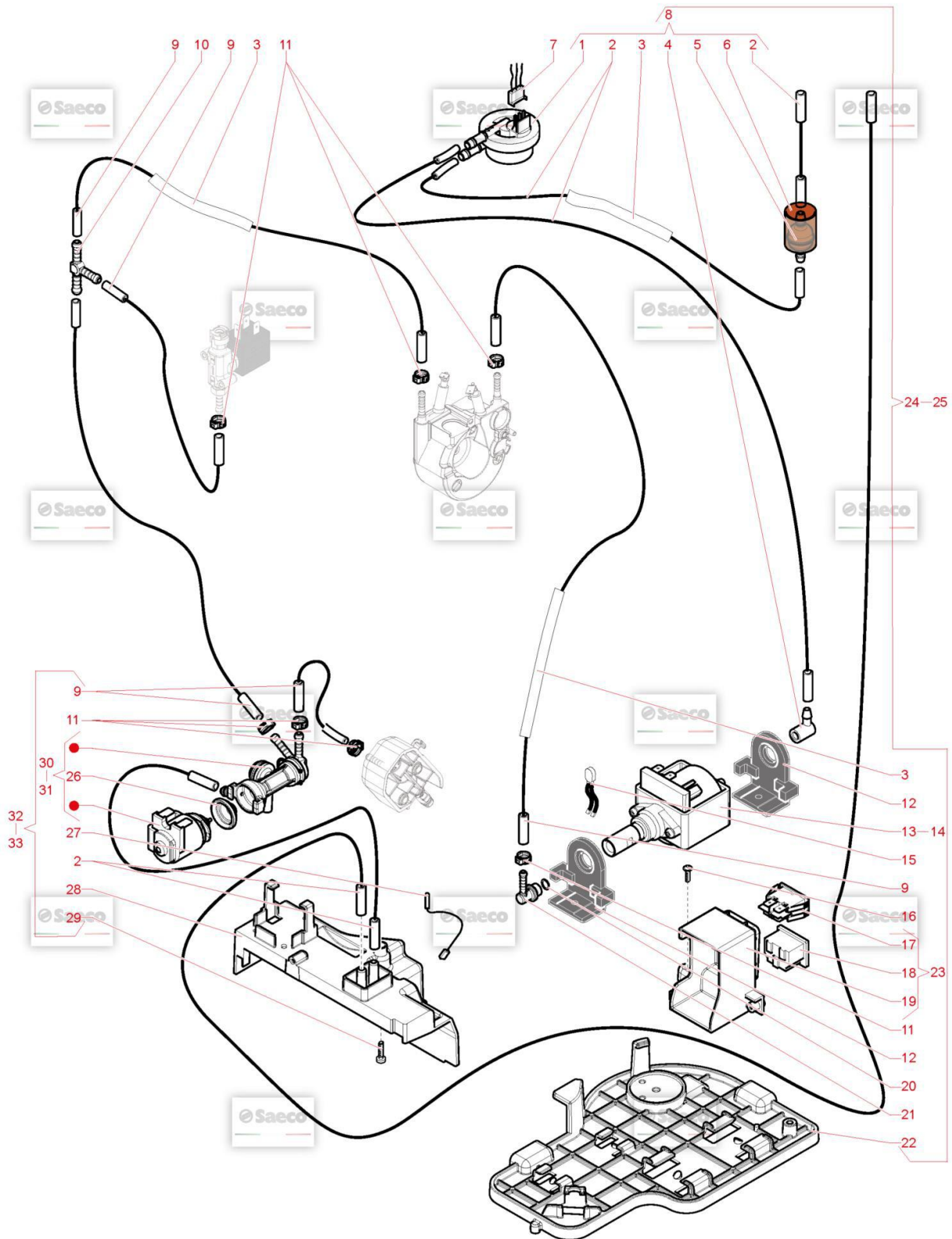

Model Machine

MACSAE314

КАВОВАРКА OCS AULIKA OFFICE V2 BLK 2 230/50SCH +KIT (10005233)

Web Pos. Foto Item - Replace by Description



Press - CTRL + CLICK go to item in a new window











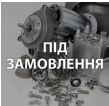

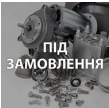













Натисніть - Ctrl + права кнопка миші щоб відкрити запчастину в новому вікні

	1		NV99.099	TURBINE D=1,2 ASSY. <i>TURBINA DIGMESA FHKSC 1,2 ARNITE OC</i>
	2		11035450	SILICONE TUBE 5X10 L.2000MM <i>TUBO SILICONE 5X10 TRASP. L.2000MM</i>
	3		11032467	SILICONE TUBE 11X12,8 L.2000 MM <i>TUBO SILICONE 11X12.8 L=2000 MM</i>
	4		147920150	90° INLET PUMP CONNECTOR <i>RACCORDO A 90° IN SANTOPRENE</i>
	5		12001595	TRANSP/WHITE ASPIRATION FILTERMDS <i>TRANSP/WHITE ASPIRATION FILTER MDS</i>
	6		147756562	BLK PROTECTION FOR FOLK SPRINGTUBE D=4 <i>BLK PROTECTION FOR FOLK SPRING TUBE D=4</i>
	7		421946001551	6P.CONN.FLOWMETER V3 RYL UL ASSY. <i>6P.CONN.FLOWMETER V3 RYL UL ASSY.</i>
	8		83A035100	GEN.TURBINE OFF RYL/T ASSYAULIKA <i>GEN.TURBINE OFF RYL/T ASSYAULIKA</i>
	9		11027788	PINK 5X8,9 SILICONE TUBE L=2000MM <i>TUBO SIL.RETIN.5X8.9 L=2000MM ROSA</i>
	10		11007493	T CONNECTOR FOR BOILER P604 <i>T CONNECTOR FOR BOILER P604</i>
	11		12000892	ЗАЖИМ D.9,5 16700004 <i>OETIKER CLAMP D=9,5 16700004 (L250)</i>
	12		11022857	BLACK PUMP SUPPORT GMYB <i>BLACK PUMP SUPPORT GMYB</i>
	13		12000140	PUMP 230V-50HZ <i>ULKA PUMP EP5/S GW 230V-50HZ</i>

Model Machine

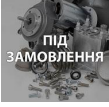
MACSAE314









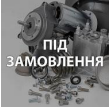

КАВОВАРКА OCS AULIKA OFFICE V2 BLK 2 230/50SCH +KIT (10005233)

	14	 ПІД ЗАМОВЛЕННЯ	12000182	ULKA PUMP EP5/S GW 220V-60HZ <i>ULKA PUMP EP5/S GW 220V-60HZ</i>
	15	 ПІД ЗАМОВЛЕННЯ	17800202	2POLES CONNECTOR COFFEE PUMP RYL UL <i>2POLES CONNECTOR COFFEE PUMP RYL UL</i>
	16		12000450	SCREW TCBR TORX 10 3,5X12 PLAST.ZN-N <i>SCREW TCBR TORX 10 3,5X12 PLAST.ZN-N</i>
	17	 ПІД ЗАМОВЛЕННЯ	NE03.038	BIPOLAR SWITCH FUSIT C1250AR <i>BIPOLAR SWITCH FUSIT C1250AR</i>
	18		12001883	CUP SOCKET V3 EN 60320 C 13 <i>CUP SOCKET V3 EN 60320 C 13</i>
	19	 ПІД ЗАМОВЛЕННЯ	17000162	BLACK SOCKET-SWITCH SUPPORT RYL <i>BLACK SOCKET-SWITCH SUPPORT RYL</i>
	20		140321961	ПРОКЛАДКА O-RING ДЛЯ КАВОМАШИНИ SAECO 2031 TERMOIL <i>OR 2031 IN TERMOIL</i>
	21		11001054	СОЕДИНИТЕЛЬНЫЙ УГОЛОК 90° К НАСОСУ P0049/B PHILIPS SAECO 996... <i>BLK PUMP OUTLET 90° CONNECTOR P0049/B</i>
	22	 ПІД ЗАМОВЛЕННЯ	17000973	BLACK COMPONENTS SUPPORT RYLO <i>BLACK COMPONENTS SUPPORT RYLO</i>
	23	 ПІД ЗАМОВЛЕННЯ	63A001400	IEC CONNECTOR RYL ASSY EU <i>IEC CONNECTOR RYL ASSY EU</i>
	24	 ПІД ЗАМОВЛЕННЯ	11034707	COMPONENTS SUPP.230V RYL V2 ASSY. <i>COMPONENTS SUPP.230V RYL V2 ASSY.</i>
	25	 ПІД ЗАМОВЛЕННЯ	11034708	COMPONENTS SUPP. 220 BRA RYL V2 ASSY. <i>COMPONENTS SUPP. 220 BRA RYL V2 ASSY.</i>
	26		11001513	МЕМБРАНА КЛАПАНА AULIKA, ODEA SAECO <i>GUARNIZ. A MEMBRANA VALV. SCARICO</i>
	27		17800442	2POLES CONNECT.SENSOR REED DUMP BOX CST <i>2POLES CONNECT.SENSOR REED DUMP BOX CST</i>

Model Machine

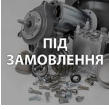
MACSAE314

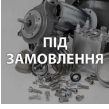
КАВОВАРКА OCS AULIKA OFFICE V2 BLK 2 230/50SCH +KIT (10005233)

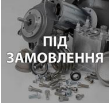
	28	 ПІД ЗАМОВЛЕННЯ	17000165	BLACK DRIP TRAY PROTECTION RYL <i>BLACK DRIP TRAY PROTECTION RYL</i>
	29		129913902	SCREW TCB TORX 10 3X12 PLAST.ZN-B <i>SCREW TCB TORX 10 3X12 PLAST.ZN-B</i>
	30		11025742	BLOWDOWN VALVE V3 RYL 230V ASSY. <i>BLOWDOWN VALVE V3 RYL 230V ASSY.</i>
	31	 ПІД ЗАМОВЛЕННЯ	11028161	BLOWDOWN VALVE V3 RYL 220V-60HZ ASSY. <i>BLOWDOWN VALVE V3 RYL 220V-60HZ ASSY.</i>
	32	 ПІД ЗАМОВЛЕННЯ	11035973	230V/BLK PROT+BLOWDOWN VALVE RYL/H ASSY. <i>230V/BLK PROT+BLOWDOWN VALVE RYL/H ASSY.</i>
	33	 ПІД ЗАМОВЛЕННЯ	11036862	220V/BLK PROT+BLOWDOWN VALVE RYL/O ASSY. <i>220V/BLK PROT+BLOWDOWN VALVE RYL/O ASSY.</i>

Model Machine

MACSAE314

KABOBAPKA OCS AULIKA OFFICE V2 BLK 2 230/50SCH +KIT (10005233)

MACSAE314.T.0006

TAVOLA NR. 6 - ARTICOLO KABOBAPKA OCS AULIKA OFFICE V2 BLK 2 230/50SCH +KIT (10005233

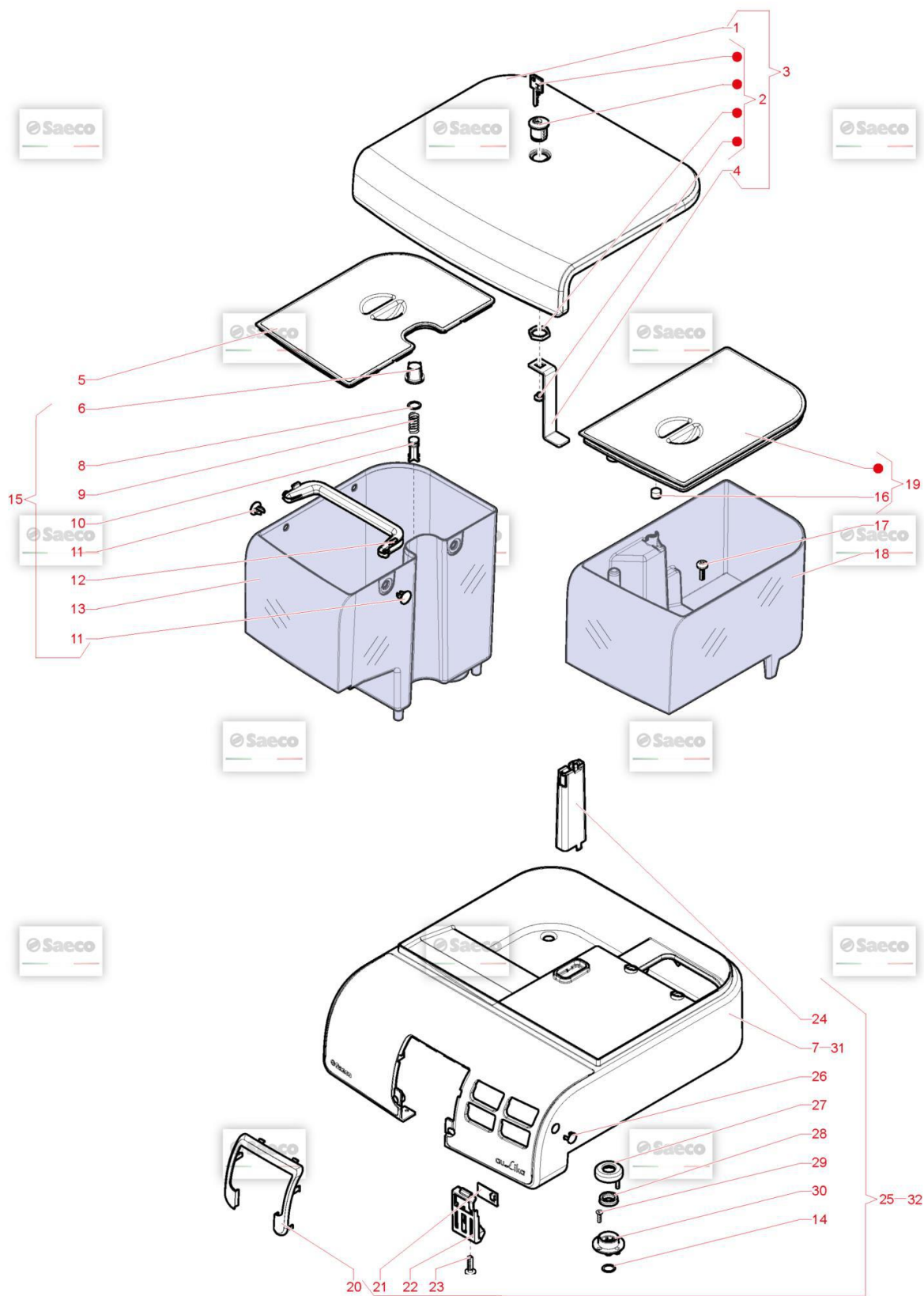

Model Machine

MACSAE314

КАВОВАРКА OCS AULIKA OFFICE V2 BLK 2 230/50SCH +KIT (10005233)

Web Pos. Foto Item - Replace by Description



*Press - CTRL + CLICK go to item in a new window
Натисніть - Ctrl + права кнопка миші щоб відкрити запчастину в новому вікні*



1

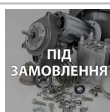

421941301051

UNPAINT.BLK CONTAINERS LID RYLO
COP.CONTENTORI RYLO NER.D/VERN.



2



12001902

LOCK MERONI 337
LOCK MERONI 337



3

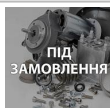

11035209

BLK W/LOCK CONTAINERS LID RYLOASSY.
AS.COP.CONT.C/SERRATURA RYLO NER



4

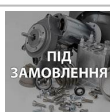

17001987

STEEL CONTAINERS LID LOCK BRACKET RYLO
STEEL CONTAINERS LID LOCK BRACKET RYLO



5



11025848

BLACK WATER CONTAINER LID RYLO
COPERCHIO.CONTENTITORE.ACQUA.NERO LID RYLO



6

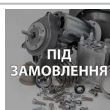

11036095

WHITE WATER CONTAINER EXT.FILTER ASSY.UL
WHITE WATER CONTAINER EXT.FILTER ASSY.UL



7

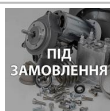

11035208

BLK CASING COVER S/SCR.RYLO/OASSY.
AS.COP.CARC.RYLO/O BLK SER.



8



140324362

OR ORM 0060-30 SILICONE
OR METRIC 0060-30 IN SILICONE



9



126764718

SS WATER CONTAINER VALVE SPRING
SS WATER CONTAINER VALVE SPRING



10



147660562

GREY PISTON FOR WATER CONTAINER VALVE
GREY PISTON FOR WATER CONTAINER VALVE



11



17001255

ЗАТИЧКА 1 ШТ
BLACK PLUG FOR WATER CONTAIN.HANDLE RYL



12



11025847

BLACK HANDLE WATER CONTAINER LID RYLO
BLACK HANDLE WATER CONTAINER LID RYLO



13

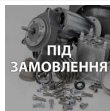

























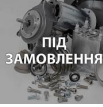

11025845

TRANSP/GREY WATER CONTAINER N/S/SCR.RYLO
TRANSP/GREY WATER CONTAINER N/S/SCR.RYLO

Model Machine

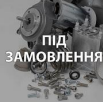
MACSAE314

КАВОВАРКА OCS AULIKA OFFICE V2 BLK 2 230/50SCH +KIT (10005233)

	14		140320461	OR ORM 0080-20 TERMOIL OR ORM 0080-20 IN TERMOIL
	15		264111	AS.CONT.ACQ.RYL/E F FILTRO S
	16		11004160	D=6 H=4 MAGNET P0049 D=6 H=4 MAGNET P0049
	17		12001431	SCREW TCB TORX 10 3X12 PLAST.SS SCREW TCB TORX 10 3X12 PLAST.SS
	18		11025841	TRANSP/GREY BEAN CONTAINER RYLO NAT/GREY BEAN CONTAINER RYLO
	19		11025844	BLACK BEAN COFFEE CONTAIN.LIDRYLO ASSY. BLACK BEAN COFFEE CONTAIN.LID RYLO ASSY.
	20		11030103	CRC FRONT PANEL RYLO CRC FRONT PANEL RYLO
	21		421941306721	ПЛАТА-СЕНСОР РІВНЯ ВОДИ V3 A CPU+SW WATER LEVEL SENSOR V3 ASSY.
	22		17001444	BLACK WATER LEVEL SENSOR SUPPORT RYLO BLACK WATER LEVEL SENSOR SUPPORT RYLO
	23		12000450	SCREW TCB TORX 10 3,5X12 PLAST.ZN-N SCREW TCB TORX 10 3,5X12 PLAST.ZN-N
	24		17000829	BLACK BEAN CONTAINER SENSOR SUPPORT RYLO BLACK BEAN CONTAINER SENSOR SUPPORT RYLO
	25		20007783	KIT SPARES TXO/BLK CASING COV.S/RYLO/O KIT RIC.COP.CARC.RYLO/O NER/TXO SER
	26		17000422	TRANSP.INFRAREDS PLATE RYL TRANSP.INFRAREDS PLATE RYL
	27		0701.031.150	GREY WATER VALVE GACO DIM 14 SEAL COVER SEAL COVER GREY

Model Machine

MACSAE314

KABOBAPKA OCS AULIKA OFFICE V2 BLK 2 230/50SCH +KIT (10005233)



28



145842900

NBR WATER CONT.VALVE GACO DIM14 SEAL
NBR WATER CONT.VALVE GACO DIM14 SEAL



29



12000895

SCREW TSP TORX 10 3X10 PLAST.SS
SCREW TSP TORX 10 3X10 PLAST.SS



30



0701.014.150

GREY WATER VALVE GACO DIM 14 SEAL CONT.
GREY WATER VALVE GACO DIM 14 SEAL CONT.

Model Machine

MACSAE314

KABOBAPKA OCS AULIKA OFFICE V2 BLK 2 230/50SCH +KIT (10005233)

MACSAE314.T.0007



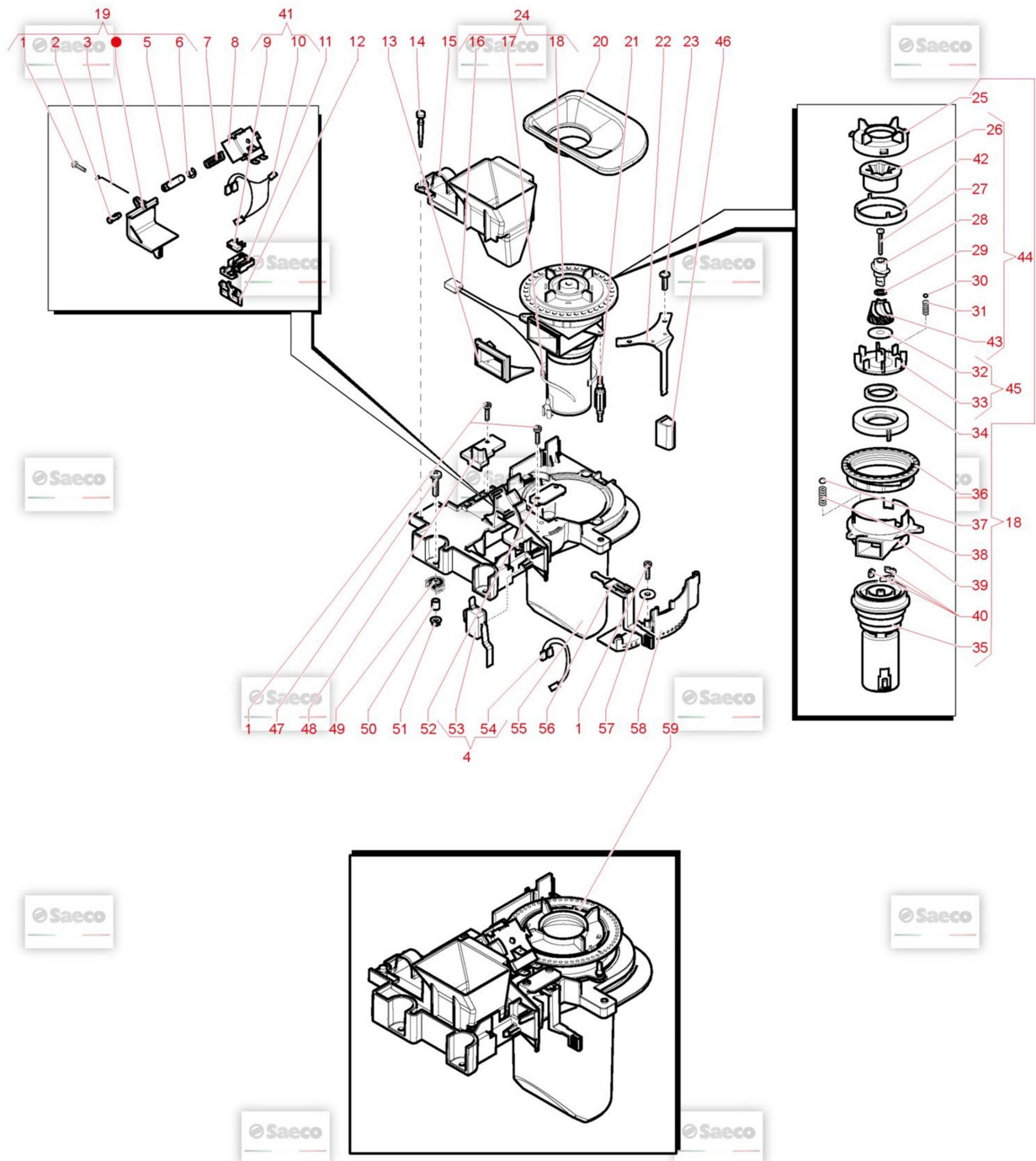























TAVOLA NR. 7 - ARTICOLO KABOBAPKA OCS AULIKA OFFICE V2 BLK 2 230/50SCH +KIT (10005233

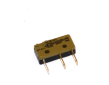

Model Machine

MACSAE314





























КАВОВАРКА OCS AULIKA OFFICE V2 BLK 2 230/50SCH +KIT (10005233)

Web	Pos.	Foto	Item - Replace by	Description
				<i>Press - CTRL + CLICK go to item in a new window Натисніть - Ctrl + права кнопка миші щоб відкрити запчастину в новому вікні</i>
	1		129913902	SCREW TCB TORX 10 3X12 PLAST.ZN-B SCREW TCB TORX 10 3X12 PLAST.ZN-B
	2		9161.076.150	GREY GROUND COF.DOSER DOOR PIN PERNO SPORTELLO DOSATORE GRIGIO
	3		9161.048	STEEL GROUND COF.DOSER SCRAPER ROD ASTA RASATORE
	4		421946000911	MICROSWITCH DOOR V2 RYL UL ASSY. AS.MICRO SPORT.V2 RYL UL
	5		9161.041	STEEL GROUND COF.DOSER ELECTROMAGN.CORE NUCLEO ELETTROMAGNETE DOSATORE
	6		U701.003	SNAP RING 7 UNI 7434 ANELLO ELASTICO 7 UNI 7434
	7		126764818	ПРУЖИНА ЕЛЕКТРОМАГНІТНОГО ДОЗАТОРА ЗЕРНА MAGIC SAECO 916... SPRING ELECTROM.BEAN DOSER MAGIC
	8		11025734	DOSER COIL FOR SUPERAUTOM.24VDC ASSY. DOSER COIL FOR SUPERAUTOM.24V DC ASSY.
	9		NE05.017	MICROSWITCH MICROSWITCH NE05.017
	10		421946000541	4P.CONN.COIL+DOSER MICRO V2 RYL UL ASSY. 4P.CONN.COIL+DOSER MICRO V2 RYL UL ASSY.
	11		9161.072.150	GREY MICRO SUPP.CURSOR GROUND COF.DOSER MICRO SUPPORT CURSOR GREY
	12		9161.073.150	GREY GROUND COF.DOSE CONTROL COMPENSATOR DOSE CONTROL COMPENSATOR GREY
	13		1505.014	COFFEEGRINDER SEAL GUARNIZIONE DOSATORE

Model Machine

MACSAE314



















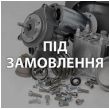

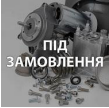

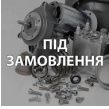

КАВОВАРКА OCS AULIKA OFFICE V2 BLK 2 230/50SCH +KIT (10005233)

	14		9161.082	RUBBER COUPLER <i>AGGANCIO IN GOMMA</i>
	15		17000176	BLACK HOPPER FOR POWDER COFFEERYL <i>BLACK HOPPER FOR POWDER COFFEE RYL</i>
	16	 ПІД ЗАМОВЛЕННЯ	421946000531	2P.CONN.GRINDER MOTOR V2 RYL UL ASSY. <i>2P.CONN.GRINDER MOTOR V2 RYL UL ASSY.</i>
	17	 ПІД ЗАМОВЛЕННЯ	144320200	SELF LOCK STRIP W=2.6 L=200 <i>SELF LOCK STRIP W=2.6 L=200</i>
	18		9140.036.00A	КАВОМОЛКА В ЗБОРІ 230V PHILIPS SAECO 996530065687 <i>COFFEE GRINDER STD 230V ASSY.</i>
	19	 ПІД ЗАМОВЛЕННЯ	9140.017	GREY GROUND COF.DOSER DOOR ASSY. <i>DOSER DOOR ASSEMBL.GREY</i>
	20		17000238	COFFEE GRINDER SOUNDPROOFING COVER RYL <i>COFFEE GRINDER SOUNDPROOFING COVER RYL</i>
	21		9991.103	АМОРТИЗАТОР ДЛЯ КОФЕМОЛКИ КОФЕМАШИН PHILIPS SAECO 996530... <i>AMMORTIZZATORE PER MACINACAFE</i>
	22		0333.008	STEEL GRINDING ADJUSTMENT LEVER <i>STEEL GRINDING ADJUSTMENT LEVER</i>
	23		12000450	SCREW TCBR TORX 10 3,5X12 PLAST.ZN-N <i>SCREW TCBR TORX 10 3,5X12 PLAST.ZN-N</i>
	24	 ПІД ЗАМОВЛЕННЯ	11027917	COFFEE GRINDER STD CALIBRATED230V ASSY. <i>AS.MACINACAFFE STD TARATO 230V</i>
	25		149186150	BLACK UPPER GRINDER SUPPORT MAGIC <i>SUPPORT.NER.X MACINA SUPERIO</i>
	26	 ПІД ЗАМОВЛЕННЯ	9141.039	UPPER GRINDER <i>UPPER GRINDER</i>
	27	 ПІД ЗАМОВЛЕННЯ	129931002	TORX SCREW T10 TCB 3,5X40 SX ZNG <i>TORX SCREW T10 TCB 3,5X40 SX ZNG</i>

Model Machine

MACSAE314

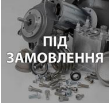









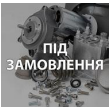















KABOBAPKA OCS AULIKA OFFICE V2 BLK 2 230/50SCH +KIT (10005233)

	28		147470763	BLK INCREASE SCREW PIN COF.GRINDER MAGIC <i>PERNO INCREM.A VITE X MACINA</i>
	29		U201.002	PLAIN WASHER 10X16X0,2DIN 988GAL <i>ROSETTA PIANA 10X16X0,2DIN</i>
	30		128610521	STAIL.STEEL AISI 304 SPHERE D=5,5MM <i>SFERA D=5,5MM ACCIAIO INOX A</i>
	31		126765517	STEEL SPRING SPHERE D=5,5 MOTOR MAGIC <i>MOLLA ACC.X SFERA D=5,5 MOTO</i>
	32	 ПІД ЗАМОВЛЕННЯ	9141.042	SAFETY RING <i>SAFETY RING</i>
	33	 ПІД ЗАМОВЛЕННЯ	9141.028	BLACK LOWER GRINDER SUPPORT MAGIC <i>BLACK LOWER GRINDER SUPPORT MAGIC</i>
	34		140360200	FELT RING 40X34X5 <i>ANELLO IN FELTRO DE=40 DI=34</i>
	35	 ПІД ЗАМОВЛЕННЯ	0301.R10.00A	SPARE MOTOR UNIT MC 230V <i>GRUPPO RICAMBIO MOTORE MC 230 V</i>
	36		146570950	RING NUT FOR GRINDING ADJUSTMENT MAGIC <i>GHIERA NERA REGOLAZ.MACINATU</i>
	37		128610421	STAIL.STELL AISI 304 SPHERE D=3,2MM <i>SFERA D=3,2MM ACCIAIO INOX A</i>
	38		126770117	NEW SPRING SPHERE D=3,2 MOTORMAGIG <i>MOLLA NEW X SFERA D=3,2 MOTORE MAGIC</i>
	39	 ПІД ЗАМОВЛЕННЯ	9141.080	ТРИМАЧ ДВИГУНА КАВОМОЛКИ ДЛЯ КАВОВАРКИ SAECO 9141.080 <i>SUPPORTO MOTORE</i>
	40		140230400	SHOCK ABS .CONICAL GRINDER SUPP.MAGIC <i>AMMORTIZ.X SUPPOR.MACIN.CONI</i>

Model Machine

MACSAE314



КАВОВАРКА OCS AULIKA OFFICE V2 BLK 2 230/50SCH +KIT (10005233)

	41	 ПІД ЗАМОВЛЕННЯ	421946000921	COIL WIRING+DOSER MICRO V2 RYLUL ASSY. <i>COIL WIRING+DOSER MICRO V2 RYLUL ASSY.</i>
	42		142844550	UPPER GRINDER COVER COFFEE GRIND. MAGIC <i>UPPER GRINDER COVER COFFEE GRIND. MAGIC</i>
	43		9141.040	CONICAL GRINDER <i>CONICAL GRINDER</i>
	44		226477700	KIT ITAL MILL GRINDERS <i>COPPIA DI MACINE SAECO CONICHE</i>
	45	 ПІД ЗАМОВЛЕННЯ	149188750	CONICAL GRIND. SUPP. + RING MAGIC <i>CONICAL GRIND. SUPP. + RING MAGIC</i>
	46	 ПІД ЗАМОВЛЕННЯ	0333.009	BLK GRINDING ADJUST.LEVER HANDGRIP ROYAL <i>BLK GRINDING ADJUST.LEVER HANDGRIP ROYAL</i>
	47		U043.004	ZN-B TCB TORX 20 M4X16 ZN-B <i>VITE TCBC M4,0X16 UNI 7687 ZNP</i>
	48	 ПІД ЗАМОВЛЕННЯ	17001155	GREY COVER FOR DOSER HOLE RYL <i>GREY COVER FOR DOSER HOLE RYL</i>
	49		9991.005	RUBBER FOR COFFEE GRINDER <i>GOMMINO X MACINA CAFFE</i>
	50		9141.003	SPACER FOR RUBBER <i>SPACER FOR RUBBER</i>
	51		U324.006	ШАЙБА M4 <i>NUT M4 FLANGED INDENTED BASE</i>
	52	 ПІД ЗАМОВЛЕННЯ	9161.097.150	GREY GROUND COF.DOSER LEVER FIXING PLATE <i>LEVER FIXING PLATE GREY</i>
	53		12001605	МІКРИК <i>MICROSWITCH</i>
	54	 ПІД ЗАМОВЛЕННЯ	421946000501	2P.CONN.DOOR MICRO V2 RYL UL ASSY. <i>2P.CONN.DOOR MICRO V2 RYL UL ASSY.</i>

Model Machine

MACSAE314

КАВОВАРКА OCS AULIKA OFFICE V2 BLK 2 230/50SCH +KIT (10005233)

	55		9161.365.150	GREY PLATE COFFEEGRINDER MAGIC/ROYAL <i>PIASTRA X MACINACAFFE' GRIGIO/7016</i>
	56	 ПІД ЗАМОВЛЕННЯ	9161.077.150	DOSE ADJUSTMENT LEVER DE LUXEGREY <i>DOSE ADJUSTMENT LEVER DE LUXE GREY</i>
	57		U201.001	PLAIN WASHER 3,2X9 DIN 7349 GALV. <i>PLAIN WASHER 3,2X9 DIN 7349 GALV.</i>
	58	 ПІД ЗАМОВЛЕННЯ	17000832	GRY COFF.GRINDING/DOSE ADJUST.SCALE RYLO <i>GRY COFF.GRINDING/DOSE ADJUST.SCALE RYLO</i>
	59	 ПІД ЗАМОВЛЕННЯ	11036571	PLATE COFFEE GRIN.V2 GEN.RYLO230V ASSY. <i>PLATE COFFEE GRIN.V2 GEN.RYLO230V ASSY.</i>

Model Machine

MACSAE314

KABOBAPKA OCS AULIKA OFFICE V2 BLK 2 230/50SCH +KIT (10005233)

MACSAE314.T.0008

TAVOLA NR. 8 - ARTICOLO KABOBAPKA OCS AULIKA OFFICE V2 BLK 2 230/50SCH +KIT (10005233

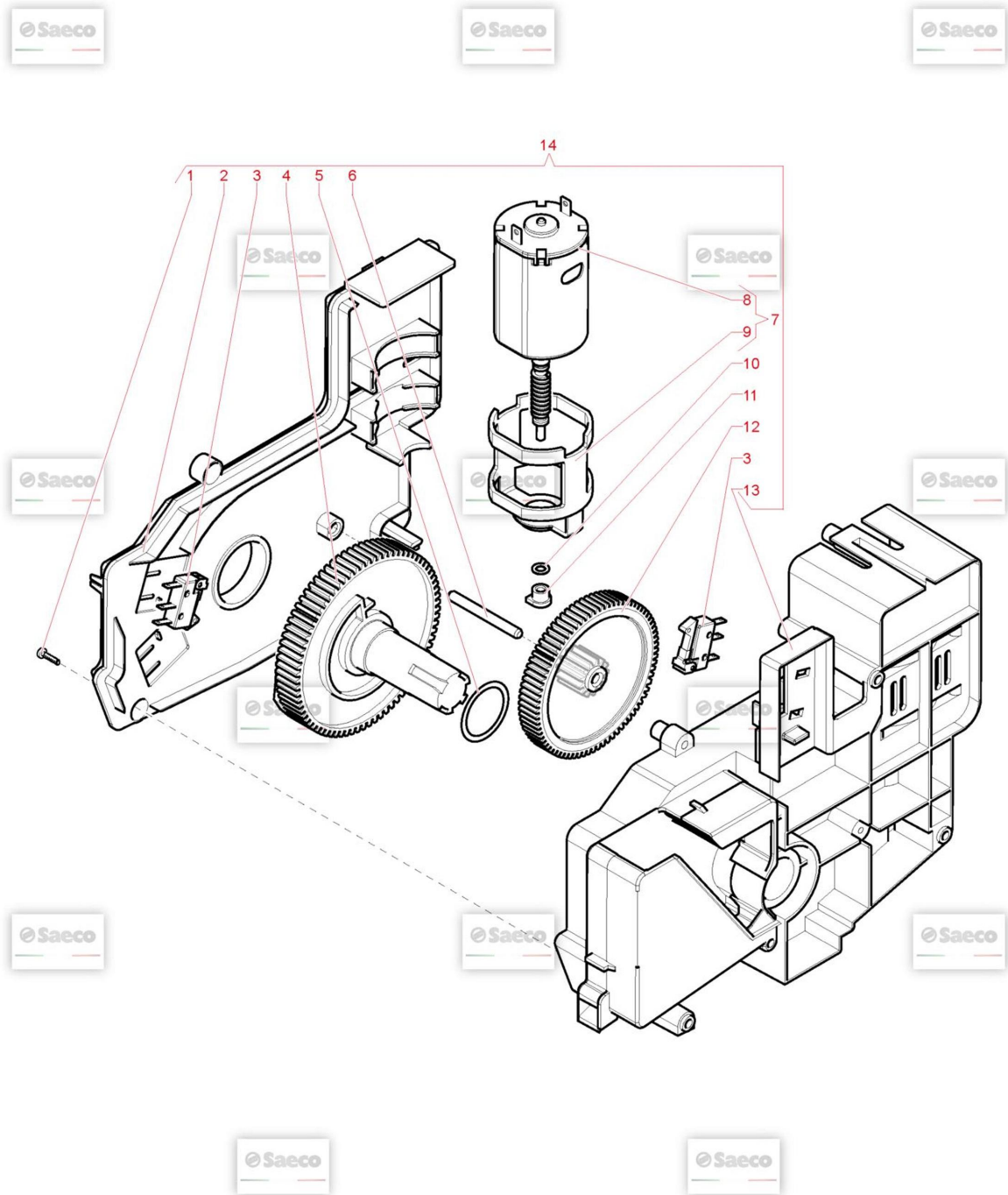

Model Machine

MACSAE314

КАВОВАРКА OCS AULIKA OFFICE V2 BLK 2 230/50SCH +KIT (10005233)

Web Pos. Foto Item - Replace by Description



Press - CTRL + CLICK go to item in a new window
Натисніть - Ctrl + права кнопка миші щоб відкрити запчастину в новому вікні



1



129670202

TCB PANELVIT SCREW 3,5X16 TESTA D=8 ZNP
TCB PANELVIT SCREW 3,5X16 TESTA D=8 ZNP



2



17000719

GREY RATIOMOTOR LID RYL
GREY RATIOMOTOR LID RYL



3



NE05.038

MICROSWITCH 30V 0.3A
MICROINTERRUTTORE



4

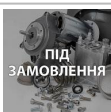

11007137

BLACK GEAR Z=77 V2 FOR RATIOMOTOR P124
BLACK GEAR Z=77 V2 FOR RATIOMOTOR P124



5



9161.368

MYLAR WASHER FOR RATIOMOTOR
RONDELLA MYLAR X MOTORIDUTTORE



6

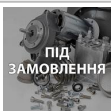

9121.039

STEEL PIN FOR RATIOMOTOR GEARMAGIC
STEEL PIN FOR RATIOMOTOR GEARMAGIC



7



11005214

MOTOR FOR RATIOMOTOR ASSY.
MOTOR FOR RATIOMOTOR P124 ASSY



8



11003037

MOTOR FOR RATIOMOTOR ASSY.
MOTOR FOR RATIOMOTOR ASSY.



9



9121.044

ANTIVIBRATION FOR MOTOR
ANTIVIBRANTE X MOTORE



10



148380200

BAKELIZZATE WASHER D=5,5
BAKELIZZATE WASHER D=5,5



11



9121.046

BRONZE SINTERED BUSH FOR MOTORRATIOMOT.
BRONZE SINTERED BUSH FOR MOTOR RATIOMOT.



12



146002800

GREY GEAR Z=13/90 FOR RATIOMOTOR P124
GREY GEAR Z=13/90 FOR RATIOMOTOR P124



13



11026258

GREY RATIOMOTOR CASING WITH TUBE ASSY.
GREY RATIOMOTOR CASING WITH TUBE ASSY.

Model Machine

MACSAE314

КАВОВАРКА OCS AULIKA OFFICE V2 BLK 2 230/50SCH +KIT (10005233)



14

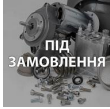

11034990

RATIOMOTOR RYL V2 ASSY.

AS.MOTORID.RYL V2

Model Machine

MACSAE314

KABOBAPKA OCS AULIKA OFFICE V2 BLK 2 230/50SCH +KIT (10005233)

MACSAE314.T.0009

TAVOLA NR. 9 - ARTICOLO KABOBAPKA OCS AULIKA OFFICE V2 BLK 2 230/50SCH +KIT (10005233

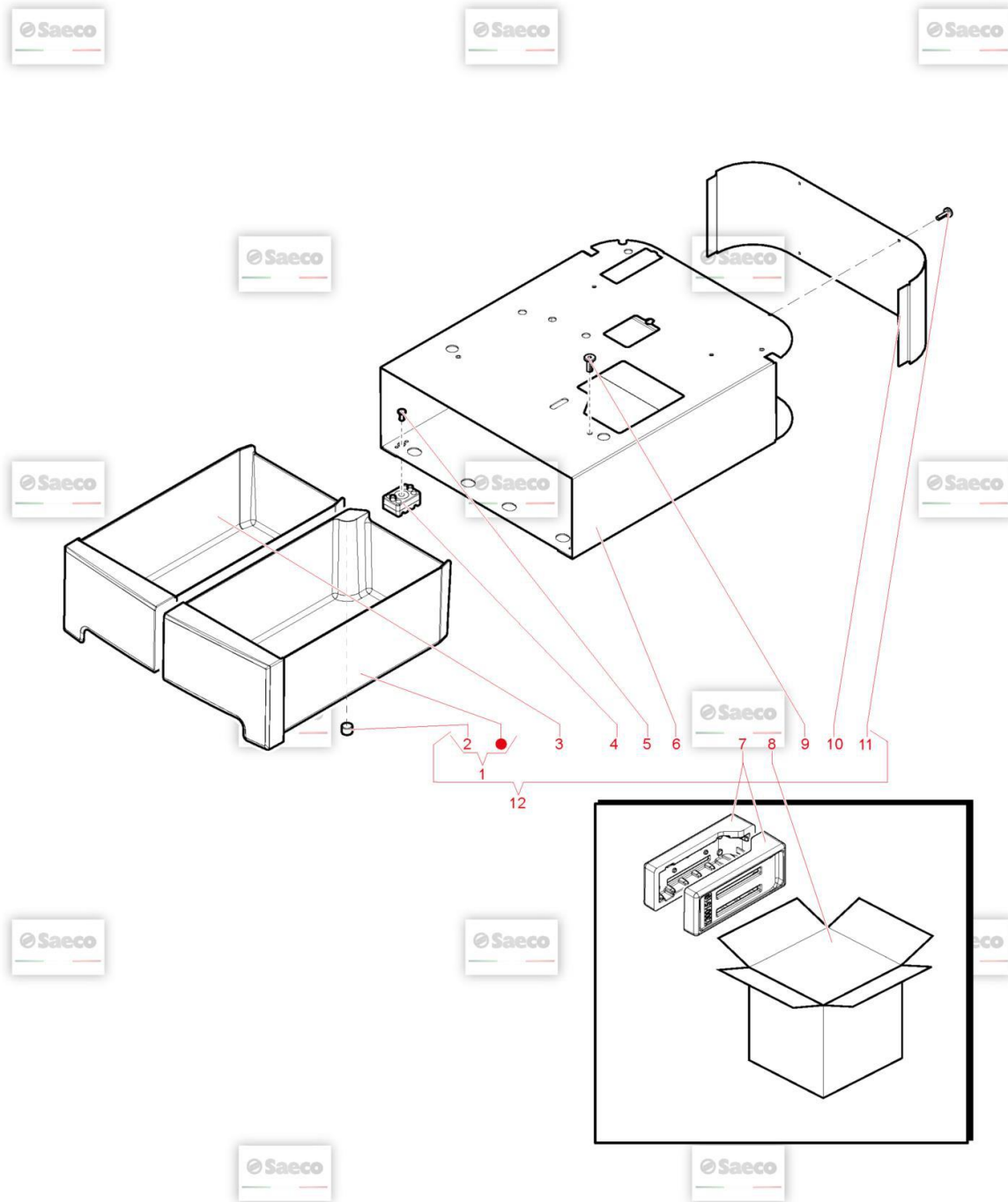













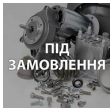



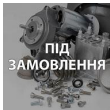





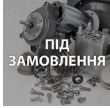

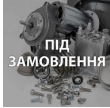
Model Machine

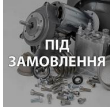
MACSAE314

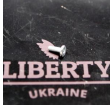
КАВОВАРКА OCS AULIKA OFFICE V2 BLK 2 230/50SCH +KIT (10005233)

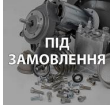
Web Pos. Foto Item - Replace by Description

 *Press - CTRL + CLICK go to item in a new window*
Натисніть - Ctrl + права кнопка миші щоб відкрити запчастину в новому вікні

	1		421941302451	UNPAINT.BASE DUMP BOX RYLO ASSY. AS.CAS.FONDI BASE RYLO NER.D/VERN.
	2		9161.111	MAGNET FOR FLOAT SUPERAUT. MAGNET FOR FLOAT SUPERAUT.
	3		421941302421	UNPAINT.BASE REPOSITORY DRAWERRYLO CAS.RIPOSTIGLIO BASE RYLO NER.D/VERN.
	4		11021829	ФІКСУЮЧИЙ НІС НИЖНІЙ ЧАСТИНІ КОРПУСУ (НІЖКИ) PHILIPS SAECO 9... BLACK/TRANSP.RIGID FOOT MYB9
	5		11021769	BLACK RIGID FOOT FIXING PIN MYB9 BLACK RIGID FOOT FIXING PIN MYB9
	6		421946005111	BLK STEEL BASE CASING V2 RYLOASSY. BLK STEEL BASE CASING V2 RYLO ASSY.
	7		13001519	PS-E INSERT FOR BOX BASE RYLO PS-E INSERT FOR BOX BASE RYLO
	8		13001676	HAVANA BOX V2 BASE RYLO HAVANA BOX V2 BASE RYLO
	9		129914302	SCREW TORX M4X10 TESTA D=8X1,5GALV SCREW TORX M4X10 TESTA D=8X1,5 GALV
	10		421944001181	BLK BASE REAR PANEL RYLO BLK BASE REAR PANEL RYLO
	11		12001622	SCREW TCB TORX B 3,5X9,5 SCHEET NIK SCREW TCB TORX B 3,5X9,5 SCHEET NIK
	12		11035262	BLK-BLK BASE RYLO ASSY. AS.BASE RYLO/O NER-NER

Model Machine

MACSAE314

KABOBAPKA OCS AULIKA OFFICE V2 BLK 2 230/50SCH +KIT (10005233)

MACSAE314.T.0010



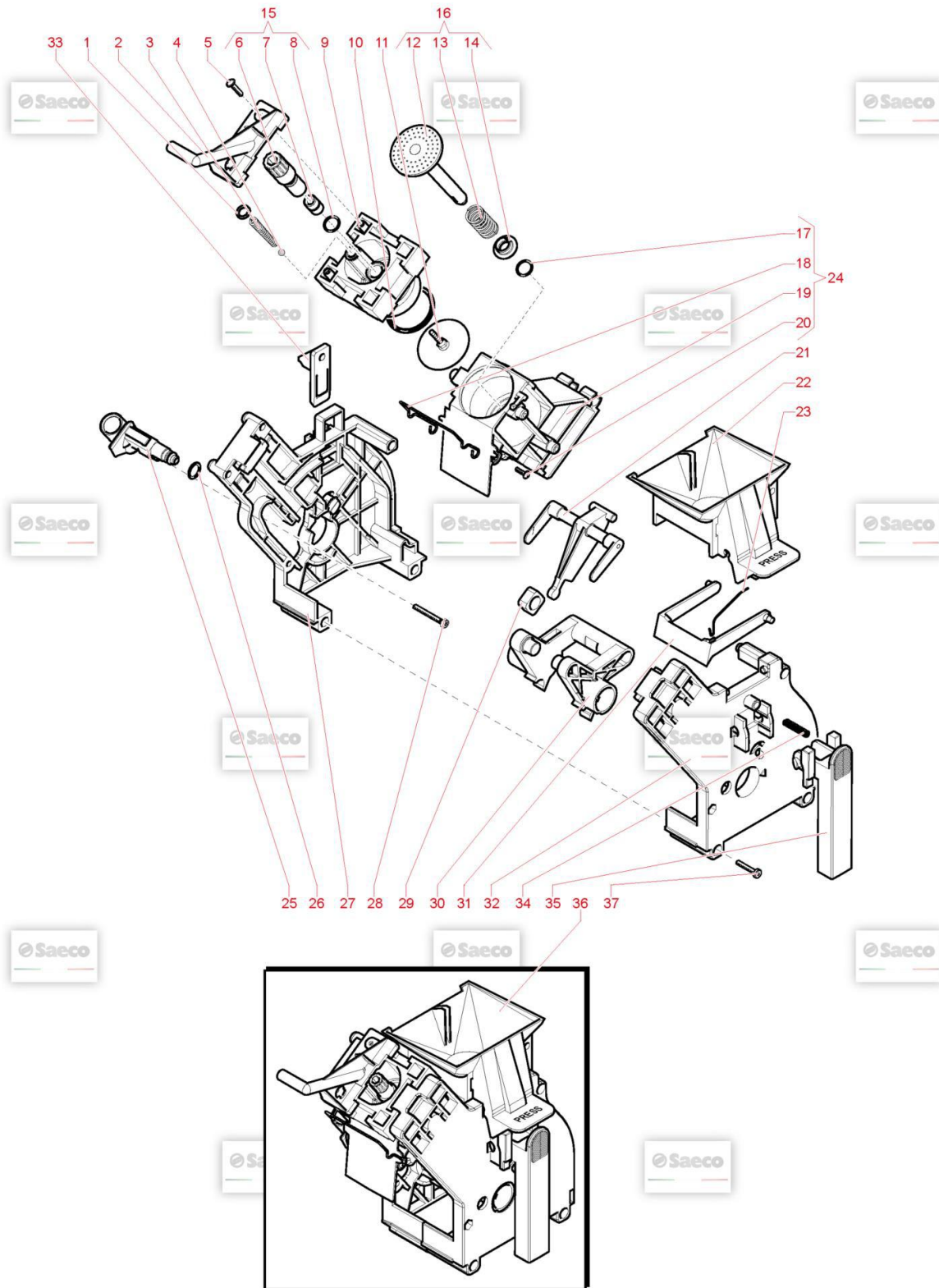















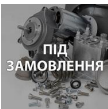



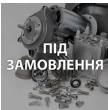

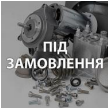

TAVOLA NR. 10 - ARTICOLO KABOBAPKA OCS AULIKA OFFICE V2 BLK 2 230/50SCH +KIT (10005233



Model Machine

MACSAE314

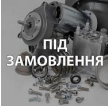























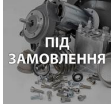

КАВОВАРКА OCS AULIKA OFFICE V2 BLK 2 230/50SCH +KIT (10005233)

Web	Pos.	Foto	Item - Replace by	Description
				<i>Press - CTRL + CLICK go to item in a new window Натисніть - Ctrl + права кнопка миші щоб відкрити запчастину в новому вікні</i>
	1		11021334	BLK COUNTERPISTON SEAL DE=11 DI=8 SP=1,4 BLK COUNTERPISTON SEAL DE=11 DI=8 SP=1,4
	2		11003789	BLACK COFF.OUTLET SLEEVE BREWUNIT ROYAL BLACK COFF.OUTLET SLEEVE BREW UNIT ROYAL,AULIKA MAGIC SAECO
	3		9161.222	SS.CONICAL SPRING MOLLA CONICA
	4		421944034451	BOROSILICATE SPHERE D.5 MM BOROSILICATE SPHERE D.5
	5		12002170	SCREW TCB TORX 10 3X16 PLAST SS VITE TCB 3X16 TORX 10 PLAST.INOX
	6		147472650	PIN BLACK FOR PERCOLATOR PIN BLACK FOR PERCOLATOR
	7		NF11.067	BRASS INSERT FOR PERCOLATOR LOCKING PIN BRASS INSERT FOR PERCOLATOR LOCKING PIN
	8		140324461	OR ORM 0060-20 TERMOIL OR ORM 0060-20 IN TERMOIL
	9		11003796	BLACK BREW UNIT COUNTERPISTONM5000 BLACK BREW UNIT COUNTERPISTON M5000
	10		NM01.044	OR ORM 0320-40 SILICONE PTFE/FDA OR ORM 0320-40 SILICONE PTFE
	11		9160.075	PERCOLATOR DE=35,8 ELFO ASSY. PERCOLATOR DE=35,8 ELFO ASSY.
	12		11003077	BLK BREW UNIT INTEGRAL PISTON8GR.ASSY. BLK BREW UNIT INTEGRAL PISTON 8GR.ASSY.
	13		9161.198	SS.8GR.BREW UNIT PISTON SPRING SS.8GR.BREW UNIT PISTON SPRING

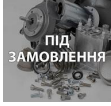
Model Machine

MACSAE314



















KABOBAPKA OCS AULIKA OFFICE V2 BLK 2 230/50SCH +KIT (10005233)

	14		9161.191	WHITE 8GR.-12GR.BREW UNIT PISTON BUSH <i>BOCCOLA X PISTONE NEUTRO</i>
	15		227470150	PIN BLACK ASS.FOR PERCOLATOR <i>PIN BLACK ASS.FOR PERCOLATOR</i>
	16		11036010	BRW 8GR.BREW UNIT NTEGR.PISTONGEN.ASSY. <i>AS.GEN.PISTONE INTEGR.GRUP.CAF.8GR.MAR.</i>
	17		NM02.018	OR ORM 0090-25 TERMOIL <i>OR ORM 0090-25 TERMOIL</i>
	18		11001556	SS BREW UNIT SPRING H=49 SMART <i>SS BREW UNIT SPRING H=49 SMART</i>
	19		421944014611	BLK COF.CONTAIN.BREW UNIT V2 M5000 ASSY. <i>BLK COF.CONTAIN.BREW UNIT V2 M5000 ASSY.</i>
	20		129912521	SCREW TCBR TORX 10 3,5X14 PLAST.SS <i>SCREW TCBR TORX 10 3,5X14 PLAST.SS</i>
	21		11003078	BLACK CONNECTING ROD BREW UNIT 8GR. <i>BLACK CONNECTING ROD BREW UNIT 8GR.</i>
	22		11003795	BLACK HOPPER COFF.BREW UNIT S/SCR.M5000 <i>BLACK HOPPER COFF.BREW UNIT S/SCR.M5000</i>
	23		9161.046	ПРУЖИНА ВОРОНКИ ЗАВАРОЧНОГО БЛОКА ДЛЯ КОФЕМАШИН PHILIPS ... <i>MOLLA X RASATORE GRUPPO</i>
	24		11004570	BLACK BREW UNIT COFFEE CONT.P124 ASSY. <i>AS.CONT.CAF.GRUP.8G.P124 NER.</i>
	25		9161.064.050	BLACK WATER INLET SLEEVE BREWUNIT ROYAL <i>BLACK WATER INLET SLEEVE BREW UNIT ROYAL</i>
	26		NM02.007	OR 2025 IN TERMOIL <i>OR 2025 TERMOIL</i>
	27		421941158532	BLACK BREW UNIT REAR PLATE V2M5000 <i>BLACK BREW UNIT REAR PLATE V2 M5000</i>

Model Machine

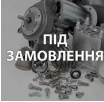
MACSAE314

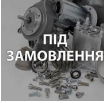
КАВОВАРКА OCS AULIKA OFFICE V2 BLK 2 230/50SCH +KIT (10005233)

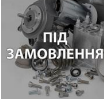
	28		12000550	CAMOPI3 TCB TORX 10 3X25 PLAST.SS SCREW TCB TORX 10 3X25 PLAST.SS
	29		9161.094.050	BLACK BREW UNIT DRILLED BLOCK BLACK BREW UNIT DRILLED BLOCK
	30		9161.066.050	BLACK BREW UNIT ELBOW SHAFT M5000 BLACK BREW UNIT ELBOW SHAFT M5000
	31		11004161	BLACK SCRAPER FOR BREW UNIT M5000 BLACK SCRAPER FOR BREW UNIT M5000
	32		11003793	BLACK BREW UNIT FRONT PLATE M5000 BLACK BREW UNIT FRONT PLATE M5000
	33		11004114	BLACK BREW UNIT COUPLING PLATE BLACK BREW UNIT COUPLING PLATE
	34		9161.045	SS BREW UNIT HANDGRIP SPRING M5000 MOLLA X IMPUGNATURA GRUPPO
	35		11003791	BLACK BREW UNIT HANDGRIP M5000 BLACK BREW UNIT HANDGRIP M5000
	36		11003800	BLACK BREW UNIT BLACK BREW UNIT MAGIC/ROYAL
	37		12000897	SCREW TCB TORX 10 3,5X20 PLAST.SS SCREW TCB TORX 10 3,5X20 PLAST.SS