

Model Machine

MACSAE199

SAECO AULIKA MID (10004471)

MACSAE199.T.0001



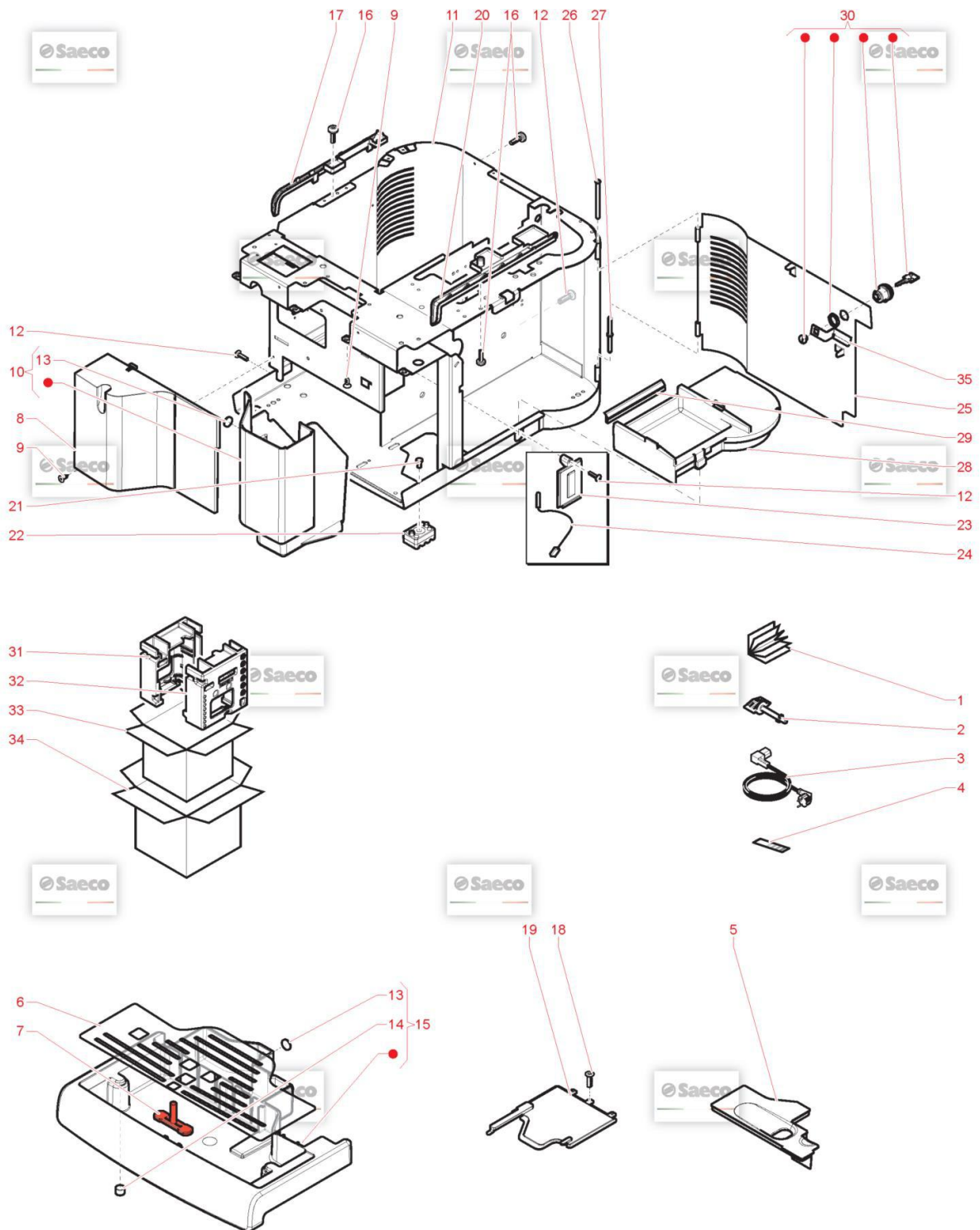









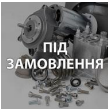

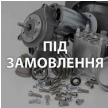

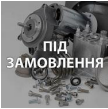

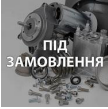

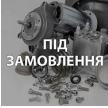

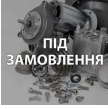

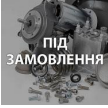
TAVOLA NR. 1 - ARTICOLO SAECO AULIKA MID (10004471)

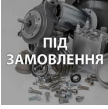

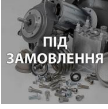
Model Machine

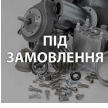
MACSAE199

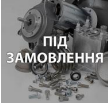

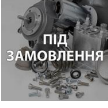













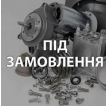









SAECO AULIKA MID (10004471)

Web	Pos.	Foto	Item - Replace by	Description
				<i>Press - CTRL + CLICK go to item in a new window Натисніть - Ctrl + права кнопка миші щоб відкрити запчастину в новому вікні</i>
	1		11035722	EXTRA SHEET SAGA FOR SAECO <i>EXTRA SHEET SAGA FOR SAECO</i>
	1		15003897	DECLARATION OF CONFORMITY RYLOSAE <i>DECLARATION OF CONFORMITY RYLOSAE</i>
	1		15004726	HARMONIZATION EXTRA SHEET MID <i>HARMONIZATION EXTRA SHEET MID</i>
	1		421940437581	MANUAL SAE SUP040RP RYLO/M IT <i>MANUAL SAE SUP040RP RYLO/M IT</i>
	1		421940437591	MANUAL SAE SUP040RP RYLO/M GB <i>MANUAL SAE SUP040RP RYLO/M GB</i>
	1		421940437601	MANUAL SAE SUP040RP RYLO/M DE <i>MANUAL SAE SUP040RP RYLO/M DE</i>
	1		421940437611	MANUAL SAE SUP040RP RYLO/M FR <i>MANUAL SAE SUP040RP RYLO/M FR</i>
	1		421940437621	MANUAL SAE SUP040RP RYLO/M ES <i>MANUAL SAE SUP040RP RYLO/M ES</i>
	1		421940437631	MANUAL SAE SUP040RP RYLO/M PT <i>MANUAL SAE SUP040RP RYLO/M PT</i>
	1		421944013871	MANUAL SAE SUP040RP RYLO/M BRA <i>MANUAL SAE SUP040RP RYLO/M BRA</i>
	1		421944015711	MANUAL SAE SUP040RP RYLO/M KOR <i>MANUAL SAE SUP040RP RYLO/M KOR</i>
	2		17000736	RED KEY FOR SAFETY MICRO RYLO <i>RED KEY FOR SAFETY MICRO RYLO</i>

Model Machine

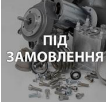
MACSAE199

















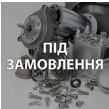





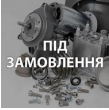

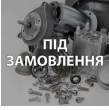

SAECO AULIKA MID (10004471)

	3		11001985	BLACK POWER CABLE KOREA L=1200 <i>BLACK POWER CABLE KOREA L=1200</i>
	3		17800019	BLACK POWER CABLE BRAZIL L=1200 <i>BLACK POWER CABLE BRAZIL L=1200</i>
	3		183911050	ЧОРНИЙ КАБЕЛЬ SCHUKO L=1200 SAECO <i>BLACK POWER CABLE SCHUKO L=1200</i>
	3		NE01.093	CABLE ARGENTINA + PLUG EN60320C13 <i>CABLE ARGENTINA + PLUG EN60320 C13</i>
	4		0301.961	STICKER FOR WATER HARDNESS TEST <i>TEST DUREZZA ACQUA</i>
	5		17000982	BLACK DRIP TRAY COVER RYL <i>BLACK DRIP TRAY COVER RYL</i>
	6		17000721	BA/SS DRIP TRAY GRATE RYL/H <i>GRIGLIA VASCA REC.ACQ.RYL/H INOX/BA</i>
	7		17000991	RED FLOAT V2 FOR DRIP TRAY RYL <i>RED FLOAT V2 FOR DRIP TRAY RYL</i>
	8		11031091	TXO/BLK FRONT CASING COVER RYL/H <i>TXO/BLK FRONT CASING COVER RYL/H</i>
	9		129535721	SCREW TSP TORX 10 AB 3,5X9,5 SHEET SS <i>SCREW TSP TORX 10 AB 3,5X9,5 SHEET SS</i>
	10		11031092	TXO/BLK DUMP BOX RYL ASSY. <i>AS.CAS.FONDI RYL VERN.NER/TXO</i>
	11		421941300651	BLK STEEL CASING RYLO/M ASSY. <i>BLK STEEL CASING RYLO/M ASSY.</i>
	12		12000450	SCREW TCBR TORX 10 3,5X12 PLAST.ZN-N <i>SCREW TCBR TORX 10 3,5X12 PLAST.ZN-N</i>
	13		9991.093	MAGNET D=9,5 X H=1,5 <i>MAGNETE D.9,5 X 1,5</i>

Model Machine

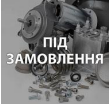
MACSAE199













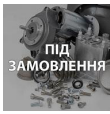

SAECO AULIKA MID (10004471)

	14		9161.111	MAGNET FOR FLOAT SUPERAUT. MAGNET FOR FLOAT SUPERAUT.
	15		11031093	TXO/BLK DRIP TRAY RYL ASSY. AS.VASCA REC.ACQ.RYL VERN.NER/TXO
	16		12001622	SCREW TCB TORX B 3,5X9,5 SCHEET NIK SCREW TCB TORX B 3,5X9,5 SCHEET NIK
	17	 ПІД ЗАМОВЛЕННЯ	421941301161	BLK CASING LEFT CLOSING INSERTRYLO/T BLK CASING LEFT CLOSING INSERTRYLO/T
	18		12000895	SCREW TSP TORX 10 3X10 PLAST.SS SCREW TSP TORX 10 3X10 PLAST.SS
	19		421944005511	ВСТАВКА ДЛЯ КОРПУСУ BLK CASING BOTTOM INSERT RYLO/M
	20	 ПІД ЗАМОВЛЕННЯ	11031307	BLACK CASING RIGHT CLOSING INSERT RYL BLACK CASING RIGHT CLOSING INSERT RYL
	21		11021769	BLACK RIGID FOOT FIXING PIN MYB9 BLACK RIGID FOOT FIXING PIN MYB9
	22		11021829	ФІКСУЮЧИЙ НІС НИЖНІЙ ЧАСТИНІ КОРПУСУ (НІЖКИ) PHILIPS SAECO 9... BLACK/TRANSP.RIGID FOOT MYB9
	23	 ПІД ЗАМОВЛЕННЯ	17000240	GREY MOUNTING PLATE INSERT RYL GREY MOUNTING PLATE INSERT RYL
	24		17800442	2POLES CONNECT.SENSOR REED DUMP BOX CST 2POLES CONNECT.SENSOR REED DUMP BOX CST
	25	 ПІД ЗАМОВЛЕННЯ	11025819	BLACK CASING DOOR RYL ASSY. BLACK CASING DOOR RYL ASSY.
	26		0301.019	NIK/BRASS PIN FOR DOOR SUPERAUT. NIK/BRASS PIN FOR DOOR SUPERAUT.
	27		0301.020	NIK/BRASS PIN FOR DOOR SUPERAUT. NIK/BRASS PIN FOR DOOR SUPERAUT.

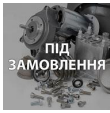
Model Machine

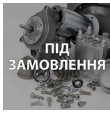
MACSAE199

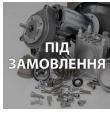
SAECO AULIKA MID (10004471)

	28		0301.041.150	GREY BREW UNIT SUPPORT PLATE ROYAL <i>PIASTRA SUPPORTO GRUPPO GRIGIO</i>
	29		9161.140	SEAL FOR UNIT PLATE <i>GUARNIZIONE X PIASTRA GRUPPO</i>
	30		12001902	LOCK MERONI 337 <i>LOCK MERONI 337</i>
	31	 ПІД ЗАМОВЛЕННЯ	13001518	PS-E LEFT INSERT FOR BOX RYLO <i>PS-E LEFT INSERT FOR BOX RYLO</i>
	32	 ПІД ЗАМОВЛЕННЯ	13001517	PS-E RIGHT INSERT FOR BOX RYLO <i>PS-E RIGHT INSERT FOR BOX RYLO</i>
	33	 ПІД ЗАМОВЛЕННЯ	13001327	HAVANA BOX RYLO SAE AULIKA <i>HAVANA BOX RYLO SAE AULIKA</i>
	34	 ПІД ЗАМОВЛЕННЯ	13001328	WHITE EXTERNAL BOX RYLO SAE <i>WHITE EXTERNAL BOX RYLO SAE</i>
	35		17001988	STEEL CASING DOOR LOCK BRACKETRYLO <i>STEEL CASING DOOR LOCK BRACKET RYLO</i>

Model Machine

MACSAE199

SAECO AULIKA MID (10004471)

MACSAE199.T.0002



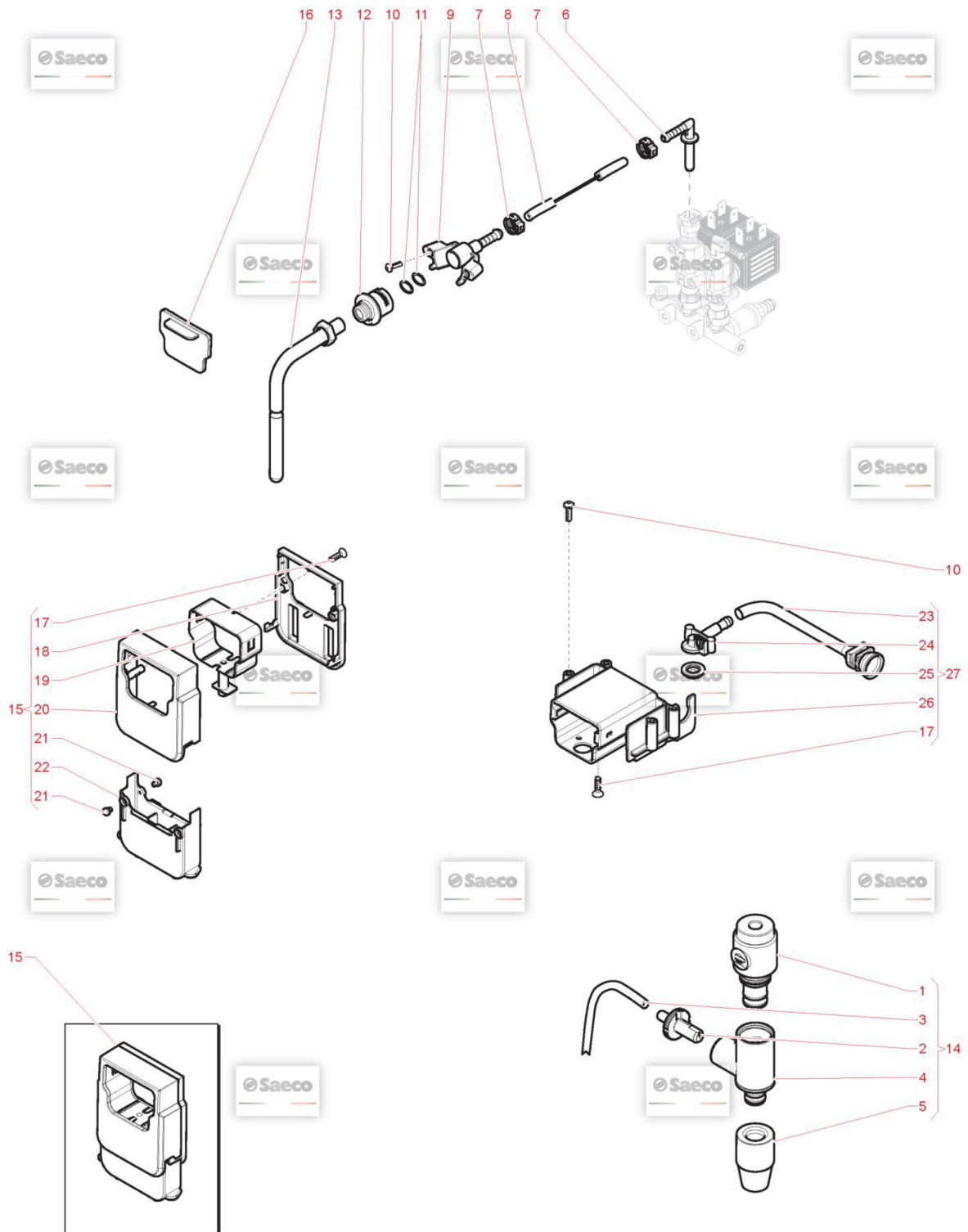













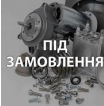





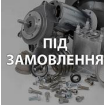

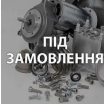

TAVOLA NR. 2 - ARTICOLO SAECO AULIKA MID (10004471)

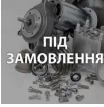

Model Machine

MACSAE199













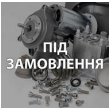













SAECO AULIKA MID (10004471)

Web	Pos.	Foto	Item - Replace by	Description
				<i>Press - CTRL + CLICK go to item in a new window Натисніть - Ctrl + права кнопка миші щоб відкрити запчастину в новому вікні</i>
	1		11026707	BLACK STEAM TUBE HANDGRIP S/SCR.NPR/H <i>BLACK STEAM TUBE HANDGRIP S/SCR.NPR/H</i>
	2		17001459	BLK CAP.MILK TUBE CONNECT.D=1,05 NPR/H <i>BLK CAP.MILK TUBE CONNECT.D=1,05 NPR/H</i>
	3		229363500	SILICONE TUBE 3,5X6 L=400 MM <i>SILICONE TUBE 3,5X6 L=400 MM</i>
	4		20007022	SPARES KIT SS/BLK CAPP.UPPER PART NPR/H <i>SPARES KIT SS/BLK CAPP.UPPER PART NPR/H</i>
	5		20007021	SPARES KIT SS/BLK CAPP.LOWER PART NPR/H <i>SPARES KIT SS/BLK CAPP.LOWER PART NPR/H</i>
	6		17002197	BLACK CAPPUCIN/STEAM TUBE CONNECT.V4 RYL <i>BLACK CAPPUCIN/STEAM TUBE CONNECT.V4 RYL</i>
	7		12000892	ЗАЖИМ D.9,5 16700004 <i>OETIKER CLAMP D=9,5 16700004 (L250)</i>
	8		11027788	PINK 5X8,9 SILICONE TUBE L=2000MM <i>TUBO SIL.RETIN.5X8.9 L=2000MM ROSA</i>
	9		17000724	BLACK STEAM TUBE SUPPORT RYL/H <i>BLACK STEAM TUBE SUPPORT RYL/H</i>
	10		12000450	SCREW TCBR TORX 10 3,5X12 PLAST.ZN-N <i>SCREW TCBR TORX 10 3,5X12 PLAST.ZN-N</i>
	11		140324461	OR ORM 0060-20 TERMOIL <i>OR ORM 0060-20 IN TERMOIL</i>
	12		11011127	ПЕРЕХІДНИК ПЛАСТИКОВИЙ P0057 <i>BLACK PA6 BUSH FOR STEAM TUBE P0057</i>
	13		11031110	TF/CHROM.STEAM TUBE D=6 RYL/HASSY. <i>TF/CHROM.STEAM TUBE D=6 RYL/H ASSY.</i>

Model Machine

MACSAE199

SAECO AULIKA MID (10004471)

	14		11028079	ЧОРНЕ РУКІВ'Я ПАРОВОЇ ТРУБКИ S/SCR.NPR/H PHILIPS SAECO 9965300... <i>BLACK STEAM TUBE HANDGRIP S/SCR.NPR/H</i>
	15	 ПІД ЗАМОВЛЕННЯ	11030101	CRC COFFEE DISPENSER RYL ASSY. <i>AS.EROG.CAF.RYL CRC</i>
	16		11031102	ФРОНТАЛЬНА КРИШКА ДІСПЕНСЕРУ <i>CRC FRONT COFFEE DISPENSER COVER RYL/H</i>
	17		12000895	SCREW TSP TORX 10 3X10 PLAST.SS <i>SCREW TSP TORX 10 3X10 PLAST.SS</i>
	18		17000248	BLACK REAR COVER COFFEE DISPENSER RYL <i>BLACK REAR COVER COFFEE DISPENSER RYL</i>
	19		17000251	BLACK INNER BODY COFFEE DISPENS.RYL <i>BLACK INNER BODY COFFEE DISPENS.RYL</i>
	20	 ПІД ЗАМОВЛЕННЯ	11030102	CRC FRONT COF.DISPENSER COVERRYL <i>CRC FRONT COF.DISPENSER COVER RYL</i>
	21		11013085	WHITE COFFEE DISPENSER SLIDERMYB9 <i>WHITE COFFEE DISPENSER SLIDER MYB9</i>
	22		17000246	ЧОРНА ЗАГЛУШКА ЧАСТИНИ КАВОВОГО ДІСПЕНСОРА <i>BLACK EXT.MOBILE PART COF.DISPENSER RYL</i>
	23		17000614	BLACK DISPENSER COFF.INLET CONNECT.RYL <i>BLACK DISPENSER COFF.INLET CONNECT.RYL</i>
	24		17000616	BLACK COFFEE DISPENSER TUBE RYL <i>BLACK COFFEE DISPENSER TUBE RYL</i>
	25		17000337	BLACK SEAL FOR COFFEE DISPENSER RYL <i>BLACK SEAL FOR COFFEE DISPENSER RYL</i>
	26		17000257	BLACK.COFFEE DISPENSER SUPPORTRYL <i>BLACK.COFFEE DISPENSER SUPPORT RYL</i>
	27	 ПІД ЗАМОВЛЕННЯ	11031103	BLK COFFEE DISPENSER SUPPORT RYL/H ASSY. <i>BLK COFFEE DISPENSER SUPPORT RYL/H ASSY.</i>

Model Machine

MACSAE199

SAECO AULIKA MID (10004471)

MACSAE199.T.0003

TAVOLA NR. 3 - ARTICOLO SAECO AULIKA MID (10004471)

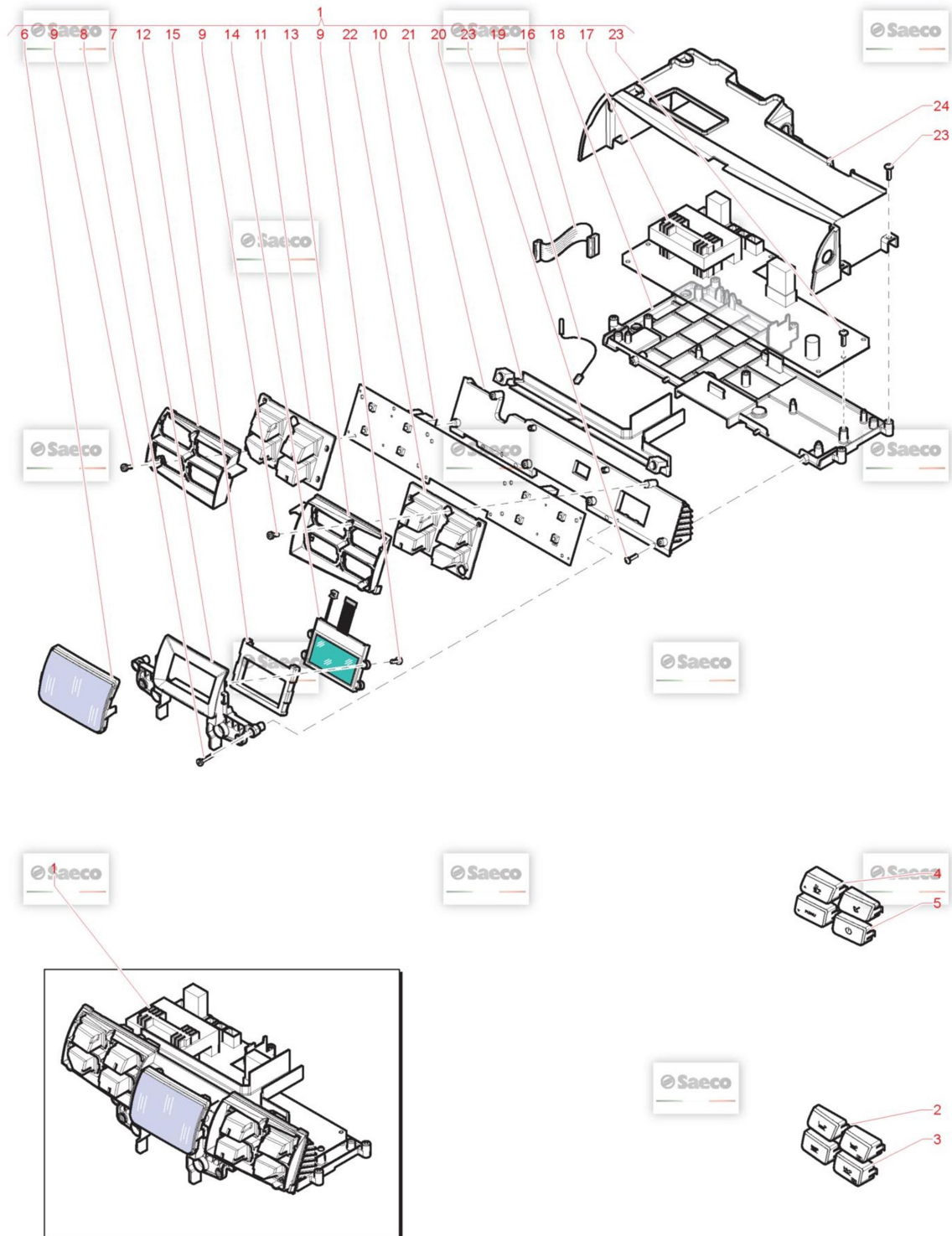

Model Machine

MACSAE199

SAECO AULIKA MID (10004471)

Web Pos. Foto Item - Replace by Description



*Press - CTRL + CLICK go to item in a new window
Натисніть - Ctrl + права кнопка миші щоб відкрити запчастину в новому вікні*



1

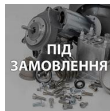

421944013801

ELECTR.PARTS 230V RYLO/M ASSY.
ELECTR.PARTS 230V RYLO/M ASSY.



2

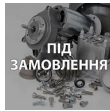

11031680

TXO/BLK LEFT UPP.T.PAN.COVER S/S.RYLO/M
TXO/BLK LEFT UPP.T.PAN.COVER S/S.RYLO/M



3

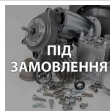

11031682

TXO/BLK LEFT LOW.T.PAN.COVER S/S.RYLO/M
TXO/BLK LEFT LOW.T.PAN.COVER S/S.RYLO/M



4



11031659

TXO/BLK RIGHT UPP.T.PAN.COVERS/S.RYLO/M
TXO/BLK RIGHT UPP.T.PAN.COVER S/S.RYLO/M



5

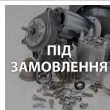

11031681

TXO/BLK RIGHT LOW.T.PAN.COVERS/S.RYLO/M
TXO/BLK RIGHT LOW.T.PAN.COVER S/S.RYLO/M



6



17000269

СКЛО ДИСПЛЕЯ PHILIPS SAECO 996530068575
TRANSP.GLASS FOR DISPLAY RYL



7



17000259

BLACK DISPLAY INSERT RYL
BLACK DISPLAY INSERT RYL



8

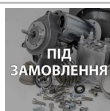

129914002

SCREW TCB TORX 10 3,5X16 PLAST.ZN-B
SCREW TCB TORX 10 3,5X16 PLAST.ZN-B



9

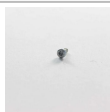

129913202

SCREW TCB TORX 10 3X8 PLAST.ZN-B
SCREW TCB TORX 10 3X8 PLAST.ZN-B



10

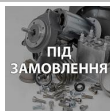

421941306161

CPU+SW RYLO/M ASSY.
AS.CPU+SW RYLO/M



11



17000485

TRANSP.LEFT TOUCH PANEL RYLO
TRANSP.LEFT TOUCH PANEL RYLO



12

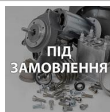

17000831

BLACK LEFT TOUCH PANEL SUPPORTRYLO
BLACK LEFT TOUCH PANEL SUPPORT RYLO



13

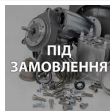















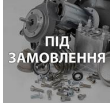



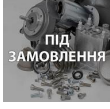

17000830

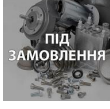
BLACK RIGHT TOUCH PANEL SUPPORT RYLO
BLACK RIGHT TOUCH PANEL SUPPORT RYLO

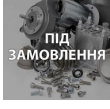
Model Machine

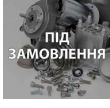
MACSAE199

SAECO AULIKA MID (10004471)

	14		12001779	WHITE DISPLAY 160X80 <i>WHITE DISPLAY 160X80 0355DP RYL</i>
	15		17000271	BLACK DISPLAY SEAL RYL <i>BLACK DISPLAY SEAL RYL</i>
	16		421946000581	14P.FLAT CABLE CPU-PWR V2 RYL <i>14P.FLAT CABLE CPU-PWR V2 RYL</i>
	17		11030311	PWR BOARD RYLO 230V <i>PWR BOARD RYLO 230V</i>
	18		17000275	BLACK PWR BOARD SUPPORT RYL <i>BLACK PWR BOARD SUPPORT RYL</i>
	19		17800442	2POLES CONNECT.SENSOR REED DUMP BOX CST <i>2POLES CONNECT.SENSOR REED DUMP BOX CST</i>
	20		17001152	POWER BOARD PROTECTION RYL <i>POWER BOARD PROTECTION RYL</i>
	21		421941277592	BLK CPU BOARD SUPPORT V2 RYL <i>BLK CPU BOARD SUPPORT V2 RYL</i>
	22		17000484	TRANSP.RIGHT TOUCH PANEL RYLO <i>TRANSP.RIGHT TOUCH PANEL RYLO</i>
	23		12000450	SCREW TCBR TORX 10 3,5X12 PLAST.ZN-N <i>SCREW TCBR TORX 10 3,5X12 PLAST.ZN-N</i>
	24		17000277	BLACK CPU-PWR BOARDS COVER RYL <i>BLACK CPU-PWR BOARDS COVER RYL</i>

Model Machine

MACSAE199

SAECO AULIKA MID (10004471)

MACSAE199.T.0004

TAVOLA NR. 4 - ARTICOLO SAECO AULIKA MID (10004471)

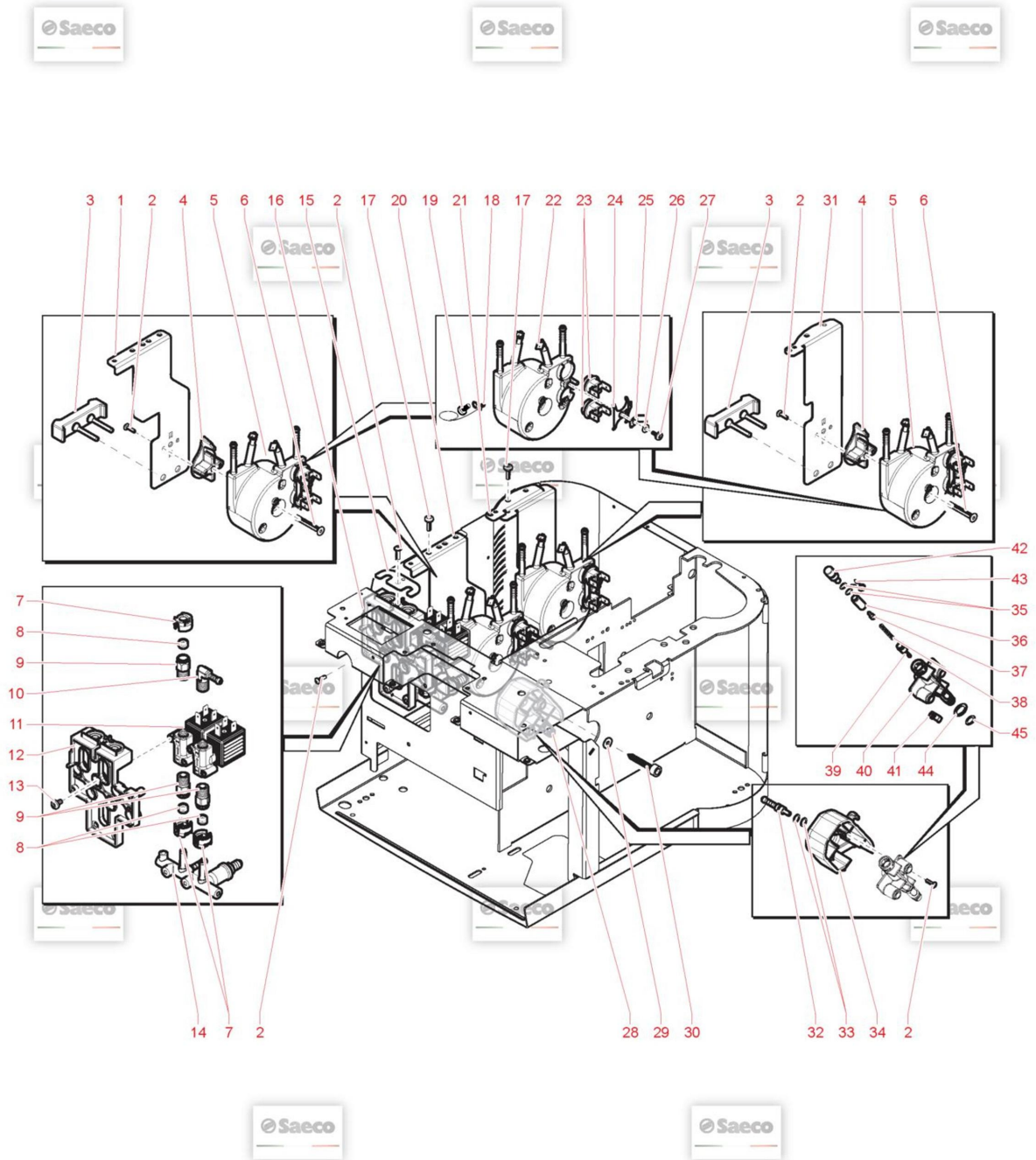

Model Machine

MACSAE199

SAECO AULIKA MID (10004471)

Web Pos. Foto Item - Replace by Description



Press - CTRL + CLICK go to item in a new window

Натисніть - Ctrl + права кнопка миші щоб відкрити запчастину в новому вікні



1

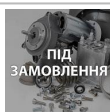

421941276892

STEEL STEAM TUBOL.BOILER SUPPORT V2 RYL
STEEL STEAM TUBOL.BOILER SUPPORT V2 RYL



2



12000450

SCREW TCBR TORX 10 3,5X12 PLAST.ZN-N
SCREW TCBR TORX 10 3,5X12 PLAST.ZN-N



3

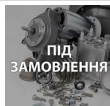

17000471

BLACK BOILER ANTIVIBRATION RYL
BLACK BOILER ANTIVIBRATION RYL



4

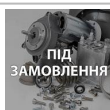

421944057621

NEU SLIM TUB.BOILERS SUPPORT V2 MYB9
NEU SLIM TUB.BOILERS SUPPORT V2 MYB9



5

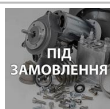

11026313

SLIM TUB.BOIL.C2 T190°-190°1300W 230V AS
AS.CALD.TUB.SLIM C2 T190°-190°1300W 230V



6

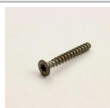

12001369

SCREW TSP TORX 10 5X35 PLAST.SS
SCREW TSP TORX 10 5X35 PLAST.SS



7



17001178

BLK EV 1/8"GAS.CONNECTOR V2 INSERT RYL
BLK EV 1/8 GAS.CONNECTOR V2 INSERT RYL



8



17001909

RED EV CONNECTOR 1/8"GAS SEALV2 RYL
RED EV CONNECTOR 1/8 GAS SEAL V2 RYL



9



11027334

З'ЄДНАННЯ 1/8"GAS V2 RYL
TEA/BRASS ELECTROV.CONNECT1/8"GAS V2 RYL



10



11024469

L-F/BRASS CONNECTOR FOR BOILER AURA
L-F/BRASS CONNECTOR FOR BOILER AURA



11



17001262

LFBRASS 2W.EV 21JN1R4V20-X031
LFBRASS 2W.EV 21JN1RRV20-X005+LBV05024CU



12

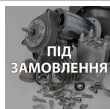

17000168

BLACK ELECTROV/CONNECTOR SUPP.RYL
BLACK ELECTROV/CONNECTOR SUPP.RYL



13

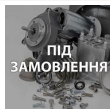











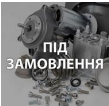

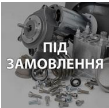













U043.012

SCREW TCB TORX 20 M4X6 ZN-B
VITE TCBC M4,0X6 UNI 7687 Z

Model Machine

MACSAE199













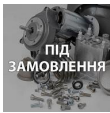

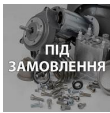

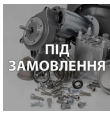



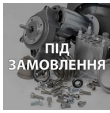



SAECO AULIKA MID (10004471)

	14		421944001431	BRASS 3W.CONN+SAFETY VALVE RYLO/M ASSY. <i>BRASS 3W.CONN+SAFETY VALVE RYLO/M ASSY.</i>
	15		17000428	STEEL CONNECTORS FIXING PLATERYL <i>STEEL CONNECTORS FIXING PLATE RYL</i>
	16		421944001441	TEA/BRASS ELECTROV.RYLO/M 24VASSY. <i>TEA/BRASS ELECTROV.RYLO/M 24V ASSY.</i>
	17		12001622	SCREW TCB TORX B 3,5X9,5 SCHEET NIK <i>SCREW TCB TORX B 3,5X9,5 SCHEET NIK</i>
	18		190800100	ТЕМПЕРАТУРНИЙ СЕНСОР NTC UL L=280MM <i>TEMPERATURE SENSOR NTC UL L=280MM</i>
	19		129573402	SCREW TAPT M4X10 DIN 7985 GALV <i>SCREW TAPT M4X10 DIN 7985 GALV</i>
	20		11025706	STEAM TUB.BOILER 230V RYL ASSY. <i>STEAM TUB.BOILER 230V RYL ASSY.</i>
	21		11025705	COFFEE TUB.BOILER 230V RYL/T ASSY. <i>COFFEE TUB.BOILER 230V RYL/T ASSY.</i>
	22		11013735	SLIM TUB.BOILER 1300W 230V ASSY. <i>SLIM TUB.BOILER 1300W 230V ASSY. NUOVO PREZZO 13,3</i>
	23		12001033	ТЕРМОСТАТ 190°C БОЙЛЕРА ДЛЯ КОФЕВАРОК PHILIPS SAECO 12001033 <i>THERMOSTAT ONE SHOT 190°</i>
	24		11001751	TUB.BOILER V3 UPPER THERM.FIXING SPRING <i>TUB.BOILER V3 UPPER THERM.FIXING SPRING</i>
	25		124390520	BRASS BENT FASTON 45° 6,3X0,8 <i>BRASS BENT FASTON 45° 6,3X0,8</i>
	26		128310402	GALV.WASHER UNI 8842 A4 <i>GALV.WASHER UNI 8842 A4</i>
	27		12001715	SCREW TCB TORX 20 M4X8 AUTOFORMING ZN-B <i>SCREW TCB TORX 20 M4X8 AUTOFORMING ZN-B</i>

Model Machine

MACSAE199











SAECO AULIKA MID (10004471)

	28		11025744	TEA/BRASS HOT WATER PIN RYL ASSY. <i>TEA/BRASS HOT WATER PIN RYL ASSY.</i>
	29		128310521	WASHER UNI 8842 A5 SS <i>WASHER UNI 8842 A5 SS</i>
	30		11003555	GALVANIZED SELF-TAPPING SCREW4,8X32 <i>GALVANIZED SELF-TAPPING SCREW 4,8X32</i>
	31		17000163	STEEL COFFEE TUBOL.BOILER SUPPORT RYL/T <i>STEEL COFFEE TUBOL.BOILER SUPPORT RYL</i>
	32		11000750	TEA/BRASS CONNECTOR FOR SILICONE TUBE <i>TEA/BRASS CONNECTOR FOR SILICONE TUBE</i>
	33		140328059	OR 2015 SILICONE PTFE/FDA <i>OR 2015 SILICONE PTFE/FDA</i>
	34		17000156	BLACK HOT WATER PIN SUPPORT RYL <i>BLACK HOT WATER PIN SUPPORT RYL</i>
	35		140326662	OR ORM 0040-20 SILICONE <i>OR METRIC 0040-20 IN SILICONE</i>
	36		11009012	TEA/BRASS BOILER PIN BUSH <i>TEA/BRASS BOILER PIN BUSH</i>
	37		11009013	TEA/BRASS PIN FOR PISTON L=10 <i>TEA/BRASS PIN FOR PISTON L=10</i>
	38		9011.132	SS SPRING FOR PIN <i>MOLLA X SPILLO</i>
	39		11009019	TEA/BRASS PISTON L=20,9 ASSY. <i>TEA/BRASS PISTON L=20,9 ASSY.</i>
	40		9161.434	HOT WATER PIN <i>PERNO CALDAIA MAGIC,ROYAL SAECO</i>

Model Machine

MACSAE199

SAECO AULIKA MID (10004471)

	41		11005099	NATURAL CURSOR V2 FOR BOILER P119 <i>NATURAL CURSOR V2 FOR BOILER P119</i>
	42		11026413	TEA/BRASS HOT WATER PIN PLUG RYL <i>TEA/BRASS HOT WATER PIN PLUG RYL</i>
	43		9011.144	SS FORK FOR TUBE D=4 <i>FORCELLA X TUBO D.4</i>
	44		NM01.035	OR ORM 0090-20 SILICONE <i>OR ORM 0090-20 SILICONE</i>
	45		NM01.057	OR ORM 0050-20 IN SILICONE <i>OR ORM 0050-20 IN SILICONE</i>

Model Machine

MACSAE199

SAECO AULIKA MID (10004471)

MACSAE199.T.0005

TAVOLA NR. 5 - ARTICOLO SAECO AULIKA MID (10004471)

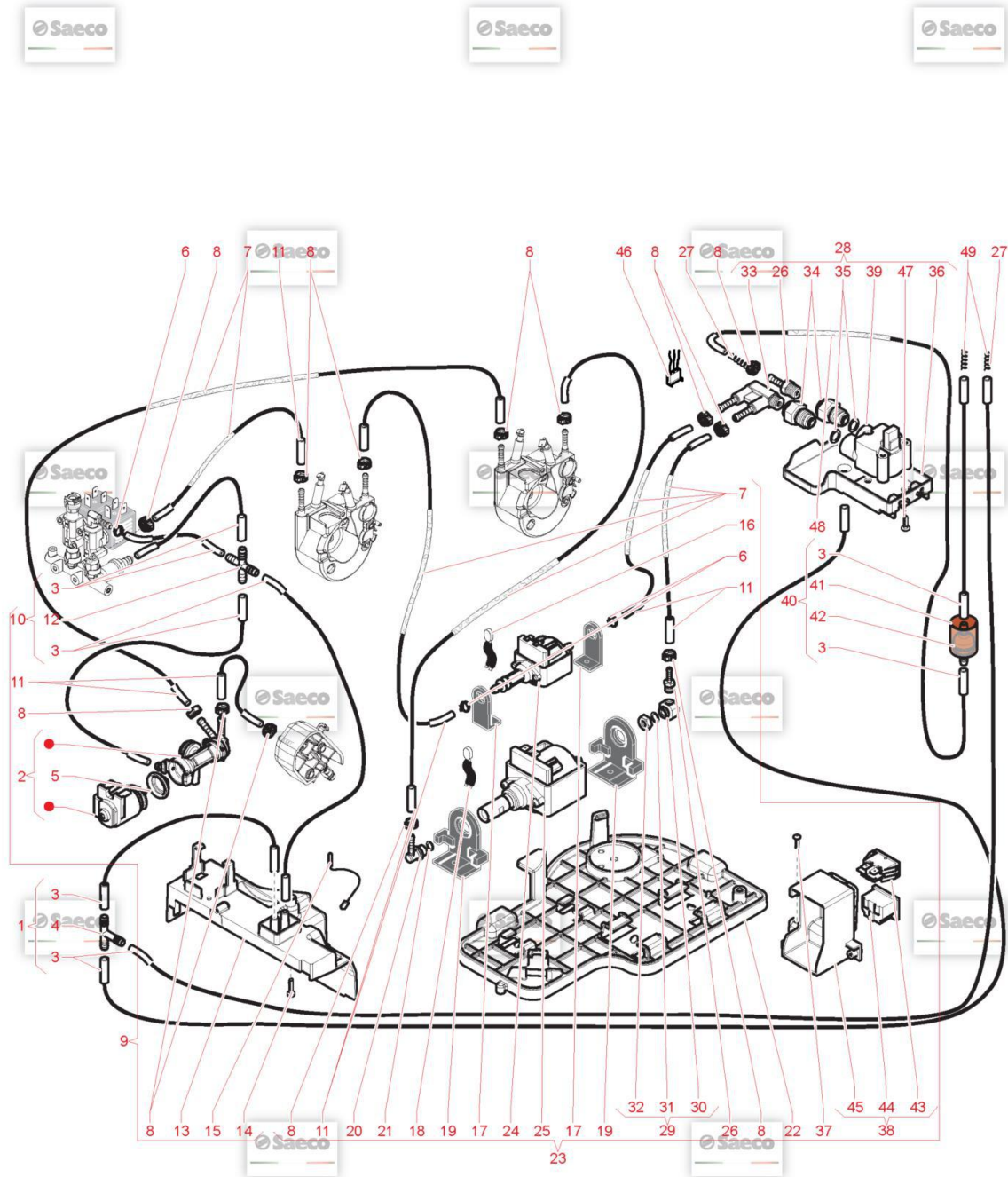

Model Machine

MACSAE199

SAECO AULIKA MID (10004471)

Web Pos. Foto Item - Replace by Description



Press - CTRL + CLICK go to item in a new window

Натисніть - Ctrl + права кнопка миші щоб відкрити запчастину в новому вікні



1

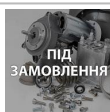

11029674

WATER CONT/TURBINE DRAIN TUBESRYLO ASSY
WATER CONT/TURBINE DRAIN TUBESRYLO ASSY



2



11025742

BLOWDOWN VALVE V3 RYL 230V ASSY.
BLOWDOWN VALVE V3 RYL 230V ASSY.



2

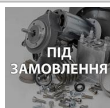

11028161

BLOWDOWN VALVE V3 RYL 220V-60HZ ASSY.
BLOWDOWN VALVE V3 RYL 220V-60HZ ASSY.



3

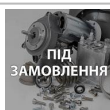

11035450

SILICONE TUBE 5X10 L.2000MM
TUBO SILICONE 5X10 TRASP. L.2000MM



4



147920300

TRANS.CONNECTOR D=8 ART.80.26.047 KA.461
RACCORDO T D=8 ART.80.26.047 KA.461



5



11001513

МЕМБРАНА КЛАПАНА AULIKA, ODEA SAECO
GUARNIZ. A MEMBRANA VALV. SCARICO



6



184320200

SPRING HOSE CLAMP D=9,5MM
MOLLA STRINGITUBO D=9,5MM



7

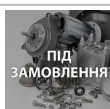

11032467

SILICONE TUBE 11X12,8 L.2000 MM
TUBO SILICONE 11X12.8 L=2000 MM



8



12000892

ЗАЖИМ D.9,5 16700004
OETIKER CLAMP D=9,5 16700004 (L250)



9

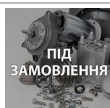

11030199

230V/BLK PROT+BLOWDOWN VALVE RYLO ASSY.
230V/BLK PROT+BLOWDOWN VALVE RYLO ASSY.



9

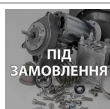

11030869

220V/BLK PROT+BLOWDOWN VALVE RYLO ASSY.
220V/BLK PROT+BLOWDOWN VALVE RYLO ASSY.



10

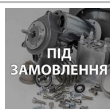

11030213

SAFETY VALVE/EV DRAIN TUBES RYLO ASSY.
SAFETY VALVE/EV DRAIN TUBES RYLO ASSY.



11

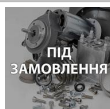











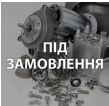

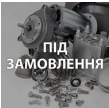













11027788

PINK 5X8,9 SILICONE TUBE L=2000MM
TUBO SIL.RETIN.5X8.9 L=2000MM ROSA

Model Machine

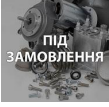
MACSAE199























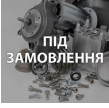

SAECO AULIKA MID (10004471)

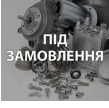
	12		12001812	TRANSP.CROSS CONNECTOR D=8 RYLO <i>TRANSP.CROSS CONNECTOR D=8 RYLO</i>
	13		17000165	BLACK DRIP TRAY PROTECTION RYL <i>BLACK DRIP TRAY PROTECTION RYL</i>
	14		129913902	SCREW TCB TORX 10 3X12 PLAST.ZN-B <i>SCREW TCB TORX 10 3X12 PLAST.ZN-B</i>
	15		17800442	2POLES CONNECT.SENSOR REED DUMP BOX CST <i>2POLES CONNECT.SENSOR REED DUMP BOX CST</i>
	16		17800203	ДВОПОЛЮСОВИЙ ДАТЧИК ПЕРЕГРІВУ ПОМПИ ВЗБОРІ PHILIPS SAECO ... <i>2POLES CONNECTOR STEAM PUMP RYL UL</i>
	17		11029554	BLACK/SBD ULKA MF PUMP SUPPORT <i>BLACK/SBD ULKA MF PUMP SUPPORT</i>
	18		17800202	2POLES CONNECTOR COFFEE PUMP RYL UL <i>2POLES CONNECTOR COFFEE PUMP RYL UL</i>
	19		11022857	BLACK PUMP SUPPORT GMYB <i>BLACK PUMP SUPPORT GMYB</i>
	20		11001054	СОЕДИНИТЕЛЬНЫЙ УГОЛОК 90° К НАСОСУ P0049/B PHILIPS SAECO 996... <i>BLK PUMP OUTLET 90° CONNECTOR P0049/B</i>
	21		140321961	ПРОКЛАДКА O-RING ДЛЯ КАВОМАШИНИ SAECO 2031 TERMOIL <i>OR 2031 IN TERMOIL</i>
	22		17000973	BLACK COMPONENTS SUPPORT RYLO <i>BLACK COMPONENTS SUPPORT RYLO</i>
	23		11030868	COMPONENTS SUPP.220V RYLO ASSY. <i>COMPONENTS SUPP.220V RYLO ASSY.</i>
	23		421944023731	COMPONENTS SUPP.V2 230V RYLO ASSY. <i>AS.SUPP.COMPONENTI V2 RYLO 230V</i>
	24		12001212	ULKA PUMP MF 230V-50HZ <i>ULKA PUMP MF 230V-50HZ</i>

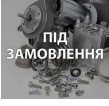
Model Machine

MACSAE199











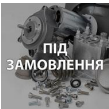



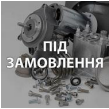



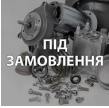





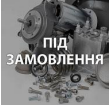

SAECO AULIKA MID (10004471)

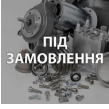
	24		12001348	ULKA PUMP MF 220V-50/60HZ <i>ULKA PUMP MF 220V-50/60HZ</i>
	25		12000182	ULKA PUMP EP5/S GW 220V-60HZ <i>ULKA PUMP EP5/S GW 220V-60HZ</i>
	25		421941305991	ULKA PUMP EP5FMGW 230V-50HZ <i>ULKA PUMP EP5FMGW 230V-50HZ</i>
	26		11006304	TEA/BRASS CONNECTOR FOR ALUM. BOILER <i>TEA/BRASS CONNECTOR FOR ALUM. BOILER</i>
	27		0701.081	SPRING FOR TUBE PRODUCT 1 <i>SPRING FOR TUBE PRODUCT 1</i>
	28		11025871	GEN. TURBINE RYLO ASSY. <i>GEN. TURBINE RYLO ASSY.</i>
	29		9079.A37	REAR CONN. ASS. M5 FOR ULKA PUMP <i>REAR CONN. ASS. M5 FOR ULKA PUMP</i>
	30		9181.350	TEA/BRASS REAR CONNECTOR 1/8" ULKA PUMP <i>TEA/BRASS REAR CONNECTOR 1/8 ULKA PUMP</i>
	31		NM03.017	O-RING R6 NBR <i>OR R6 NBR</i>
	32		9071.054	BRASS NUT FOR ULKA PUMP REAR CONNECTOR <i>BRASS NUT FOR ULKA PUMP REAR CONNECTOR</i>
	33		11010243	TEA/BRASS 90° DOUBLE CONNECTOR <i>TEA/BRASS 90° DOUBLE CONNECTOR</i>
	34		9181.406	TEA/BRASS CONNECTOR TURBINE MF 1/4 1/8 <i>TEA/BRASS CONNECTOR TURBINE MF 1/4 1/8</i>
	35		NM01.049	OR ORM 0070-20 SILICONE <i>OR ORM 0070-20 SILICONE</i>

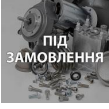
Model Machine

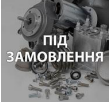
MACSAE199

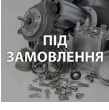
SAECO AULIKA MID (10004471)

	36		17000821	BLACK TURBINE SUPPORT RYLO <i>BLACK TURBINE SUPPORT RYLO</i>
	37		12000450	SCREW TCBR TORX 10 3,5X12 PLAST.ZN-N <i>SCREW TCBR TORX 10 3,5X12 PLAST.ZN-N</i>
	38		421941294291	IEC CONNECTOR V2 RYL ASSY. <i>IEC CONNECTOR V2 RYL ASSY.</i>
	39		NV99.033	ПЛАСТИКОВА ТУРБИНА ВИСОКОГО ТИСКУ <i>TURBINA DIGMESA IN PLASTICA</i>
	40		421941301931	ASPIRATION TUBES RYLO/M ASSY. <i>ASPIRATION TUBES RYLO/M ASSY.</i>
	41		147756562	BLK PROTECTION FOR FOLK SPRINGTUBE D=4 <i>BLK PROTECTION FOR FOLK SPRING TUBE D=4</i>
	42		12001595	TRANSP/WHITE ASPIRATION FILTERMDS <i>TRANSP/WHITE ASPIRATION FILTER MDS</i>
	43		NE03.038	BIPOLAR SWITCH FUSIT C1250AR <i>BIPOLAR SWITCH FUSIT C1250AR</i>
	44		12001883	CUP SOCKET V3 EN 60320 C 13 <i>CUP SOCKET V3 EN 60320 C 13</i>
	45		17000162	BLACK SOCKET-SWITCH SUPPORT RYL <i>BLACK SOCKET-SWITCH SUPPORT RYL</i>
	46		421946001561	6P.CONN.FLOWMETER V2 RYLO UL ASSY. <i>6P.CONN.FLOWMETER V2 RYLO UL ASSY.</i>
	47		129912104	SCREW TCBR TORX 20 4X10 PLAST.ZN-N <i>SCREW TCBR TORX 20 4X10 PLAST.ZN-N</i>
	48		421941305531	SILICONE TUBE 12X14 70SH L=200MM <i>SILICONE TUBE 12X14 70SH L=200MM</i>
	49		0701.082	SPRING FOR TUBE PRODUCT 2 <i>SPRING FOR TUBE PRODUCT 2</i>

Model Machine

MACSAE199

SAECO AULIKA MID (10004471)

MACSAE199.T.0006

TAVOLA NR. 6 - ARTICOLO SAECO AULIKA MID (10004471)

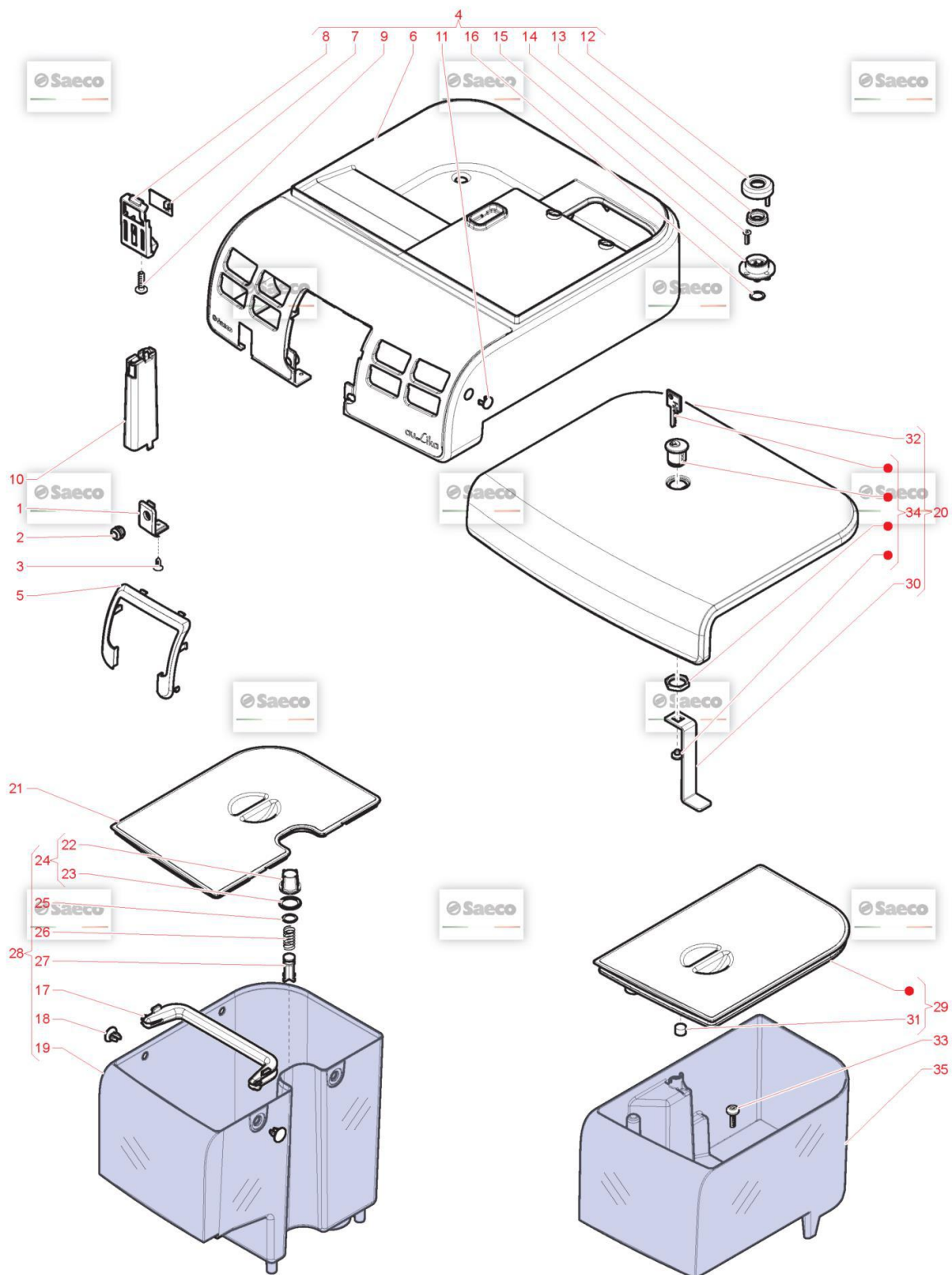

Model Machine

MACSAE199

SAECO AULIKA MID (10004471)

Web Pos. Foto Item - Replace by Description



Press - CTRL + CLICK go to item in a new window

Натисніть - Ctrl + права кнопка миші щоб відкрити запчастину в новому вікні



1

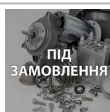

11031148

TXO/BLK COVER CASING FRONT INSERT RYL/H
TXO/BLK COVER CASING FRONT INSERT RYL/H



2

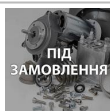

17001881

BLK SEAL BORE HOLE STEAM TUBERYL/H
BLK SEAL BORE HOLE STEAM TUBE RYL/H



3



129535721

SCREW TSP TORX 10 AB 3,5X9,5 SHEET SS
SCREW TSP TORX 10 AB 3,5X9,5 SHEET SS



4

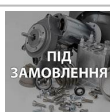

421941300961

TXO/BLK CASING COVER S/SCR.RYLO/M ASSY.
AS.COP.CARC.RYLO/M NER/TXO SER.



5



11030103

CRC FRONT PANEL RYLO
CRC FRONT PANEL RYLO



6

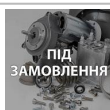

421940812981

KIT SPARES TXO/BLK CASING COV.S/S.RYLO/M
KIT SPARES TXO/BLK CASING COV.S/S.RYLO/M



7

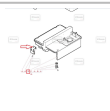

421941306721

ПЛАТА-СЕНСОР РІВНЯ ВОДИ V3 A
CPU+SW WATER LEVEL SENSOR V3 ASSY.



8

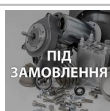

17001444

BLACK WATER LEVEL SENSOR SUPPORT RYLO
BLACK WATER LEVEL SENSOR SUPPORT RYLO



9



12000450

SCREW TCBR TORX 10 3,5X12 PLAST.ZN-N
SCREW TCBR TORX 10 3,5X12 PLAST.ZN-N



10



17000829

BLACK BEAN CONTAINER SENSOR SUPPORT RYLO
BLACK BEAN CONTAINER SENSOR SUPPORT RYLO



11

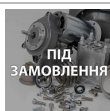

17000422

TRANSP.INFRAREDS PLATE RYL
TRANSP.INFRAREDS PLATE RYL



12



0701.031.150

GREY WATER VALVE GACO DIM 14 SEAL COVER
SEAL COVER GREY



13































145842900

NBR WATER CONT.VALVE GACO DIM14 SEAL
NBR WATER CONT.VALVE GACO DIM14 SEAL

Model Machine

MACSAE199











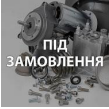

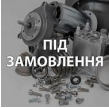

SAECO AULIKA MID (10004471)

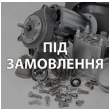
	14		12000895	SCREW TSP TORX 10 3X10 PLAST.SS SCREW TSP TORX 10 3X10 PLAST.SS
	15		0701.014.150	GREY WATER VALVE GACO DIM 14 SEAL CONT. GREY WATER VALVE GACO DIM 14 SEAL CONT.
	16		140320461	OR ORM 0080-20 TERMOIL OR ORM 0080-20 IN TERMOIL
	17		11025847	BLACK HANDLE WATER CONTAINER LID RYLO BLACK HANDLE WATER CONTAINER LID RYLO
	18		17001255	ЗАТИЧКА 1 ШТ BLACK PLUG FOR WATER CONTAIN.HANDLE RYL
	19		11029967	TRANSP/GREY WATER CONTAINER S/SCR.RYLO TRANSP/GREY WATER CONTAINER S/SCR.RYLO
	20		421941301071	TXO/BLK W/LOCK CONTAINERS LIDRYLO ASSY. AS.COP.CONT.C/SERRATURA RYLO NER/TXO
	21		11025848	BLACK WATER CONTAINER LID RYLO COPERCHIO.CONTENTITORE.ACQUA.NERO LID RYLO
	22		144650800	WHITE WATER CONTAINER EXT.FILTER WHITE WATER CONTAINER EXT.FILTER
	23		140328461	ПРОКЛАДКА O-RING 0190-10 ДЛЯ КОФЕМАШИНЫ PHILIPS SAECO 99653... OR METRICO 0190-10 IN EPDM NUOVO PREZZO 0,13
	24		224640200	БІЛИЙ ПЛАСТИКОВИЙ ФІЛЬТР У КОНТЕЙНЕР ВОДИ SAECO 996530029115 EXTERNAL FILTER FOR WATER CONTAINER ASSY
	25		140324362	OR ORM 0060-30 SILICONE OR METRIC 0060-30 IN SILICONE
	26		126764718	SS WATER CONTAINER VALVE SPRING SS WATER CONTAINER VALVE SPRING
	27		147660562	GREY PISTON FOR WATER CONTAINER VALVE GREY PISTON FOR WATER CONTAINER VALVE

Model Machine

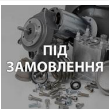
MACSAE199

SAECO AULIKA MID (10004471)

	28		11025846	TRANSP/GREY WATER CONTAINER RYLO ASSY. NAT/GREY WATER CONTAINER RYLO ASSY.
	29		11025844	BLACK BEAN COFFEE CONTAIN.LID RYLO ASSY. BLACK BEAN COFFEE CONTAIN.LID RYLO ASSY.
	30		17001987	STEEL CONTAINERS LID LOCK BRACKET RYLO STEEL CONTAINERS LID LOCK BRACKET RYLO
	31		11004160	D=6 H=4 MAGNET P0049 D=6 H=4 MAGNET P0049
	32		421941301061	TXO/BLK CONTAINERS LID RYLO TO ASSY. TXO/BLK CONTAINERS LID RYLO TO ASSY.
	33		12001431	SCREW TCB TORX 10 3X12 PLAST.SS SCREW TCB TORX 10 3X12 PLAST.SS
	34		12001902	LOCK MERONI 337 LOCK MERONI 337
	35		11025841	TRANSP/GREY BEAN CONTAINER RYLO NAT/GREY BEAN CONTAINER RYLO

Model Machine

MACSAE199

SAECO AULIKA MID (10004471)

MACSAE199.T.0007



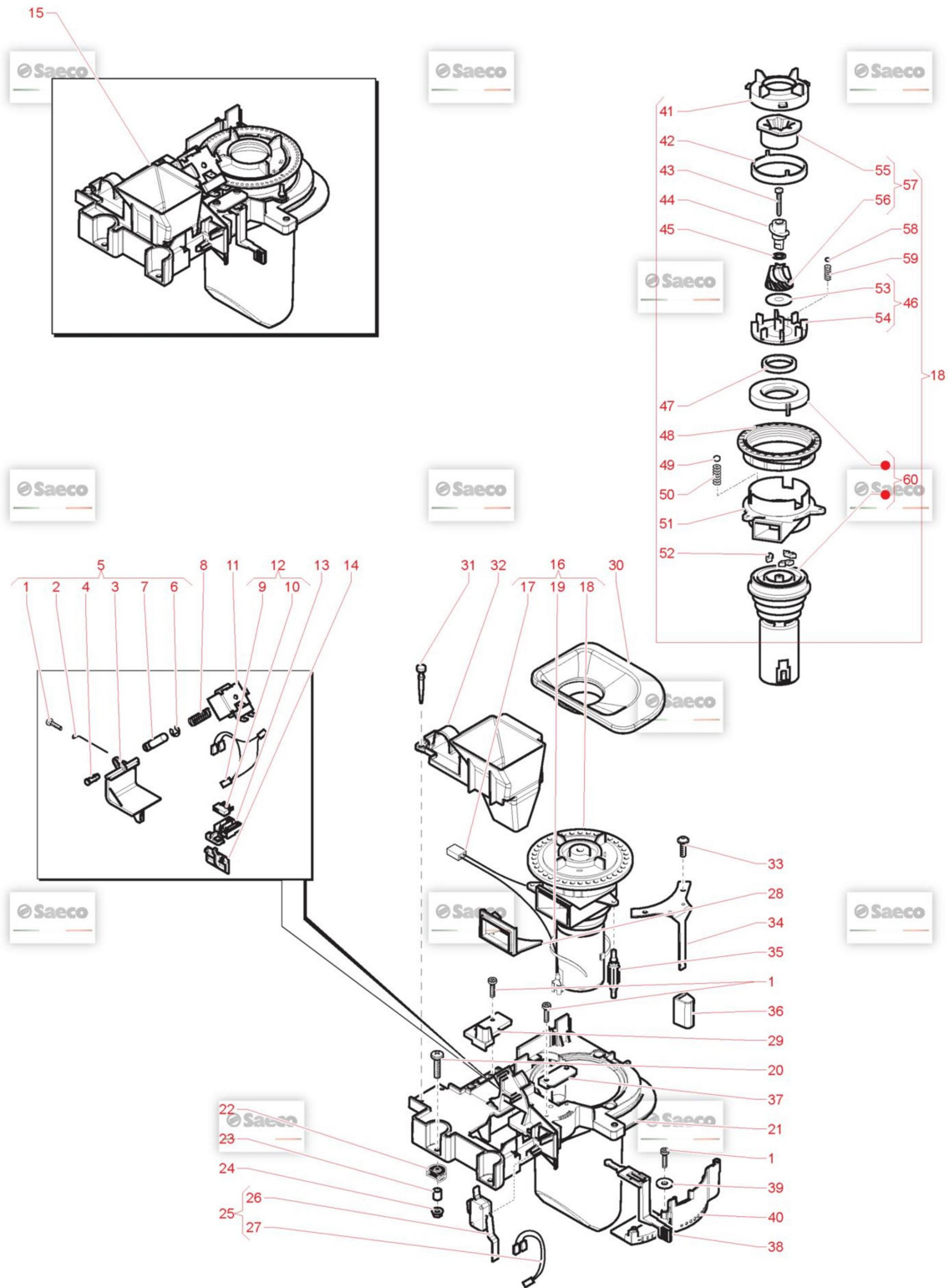























TAVOLA NR. 7 - ARTICOLO SAECO AULIKA MID (10004471)



Model Machine

MACSAE199

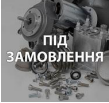











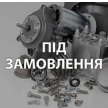













SAECO AULIKA MID (10004471)

Web	Pos.	Foto	Item - Replace by	Description
				<i>Press - CTRL + CLICK go to item in a new window Натисніть - Ctrl + права кнопка миші щоб відкрити запчастину в новому вікні</i>
	1		129913902	SCREW TCB TORX 10 3X12 PLAST.ZN-B SCREW TCB TORX 10 3X12 PLAST.ZN-B
	2		9161.048	STEEL GROUND COF.DOSER SCRAPERROD ASTA RASATORE
	3		9161.074.150	GREY GROUND COFFE DOSER DOOR SPORTELLO DOSATORE GRIGIO
	4		9161.076.150	GREY GROUND COF.DOSER DOOR PIN PERNO SPORTELLO DOSATORE GRIGIO
	5	 ПІД ЗАМОВЛЕННЯ	9140.017	GREY GROUND COF.DOSER DOOR ASSY. DOSER DOOR ASSEMBL.GREY
	6		U701.003	SNAP RING 7 UNI 7434 ANELLO ELASTICO 7 UNI 7434
	7		9161.041	STEEL GROUND COF.DOSER ELECTROMAGN.CORE NUCLEO ELETTRROMAGNETE DOSATORE
	8		126764818	ПРУЖИНА ЕЛЕКТРОМАГНІТНОГО ДОЗАТОРА ЗЕРНА MAGIC SAECO 916... SPRING ELECTROM.BEAN DOSER MAGIC
	9	 ПІД ЗАМОВЛЕННЯ	421946000541	4P.CONN.COIL+DOSER MICRO V2 RYL UL ASSY. 4P.CONN.COIL+DOSER MICRO V2 RYL UL ASSY.
	10		NE05.017	MICROSWITCH MICROSWITCH NE05.017
	11		11025734	DOSER COIL FOR SUPERAUTOM.24VDC ASSY. DOSER COIL FOR SUPERAUTOM.24V DC ASSY.
	12	 ПІД ЗАМОВЛЕННЯ	421946000921	COIL WIRING+DOSER MICRO V2 RYLUL ASSY. COIL WIRING+DOSER MICRO V2 RYLUL ASSY.
	13		9161.072.150	GREY MICRO SUPP.CURSOR GROUND COF.DOSER MICRO SUPPORT CURSOR GREY

Model Machine

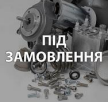
MACSAE199























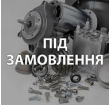

SAECO AULIKA MID (10004471)

	14		9161.073.150	GREY GROUND COF.DOSE CONTROL COMPENSATOR <i>DOSE CONTROL COMPENSATOR GREY</i>
	15		11029886	PLATE COFFEE GRINDER GEN.RYLO230V ASSY. <i>AS.GEN.PIAS.MC RYLO 230V</i>
	16		11027917	COFFEE GRINDER STD CALIBRATED230V ASSY. <i>AS.MACINACAFFE STD TARATO 230V</i>
	17		421946000531	2P.CONN.GRINDER MOTOR V2 RYL UL ASSY. <i>2P.CONN.GRINDER MOTOR V2 RYL UL ASSY.</i>
	18		9140.036.00A	КАВОМОЛКА В ЗБОРИ 230V PHILIPS SAECO 996530065687 <i>COFFEE GRINDER STD 230V ASSY.</i>
	19		144320200	SELF LOCK STRIP W=2.6 L=200 <i>SELF LOCK STRIP W=2.6 L=200</i>
	20		U043.004	ZN-B TCB TORX 20 M4X16 ZN-B <i>VITE TCBC M4,0X16 UNI 7687 ZNP</i>
	21		9161.365.150	GREY PLATE COFFEEGRINDER MAGIC/ROYAL <i>PIASTRA X MACINACAFFE' GRIGIO/7016</i>
	22		9991.005	RUBBER FOR COFFEE GRINDER <i>GOMMINO X MACINA CAFFE</i>
	23		9141.003	SPACER FOR RUBBER <i>SPACER FOR RUBBER</i>
	24		U324.006	ШАЙБА М4 <i>NUT M4 FLANGED INDENTED BASE</i>
	25		421946000911	MICROSWITCH DOOR V2 RYL UL ASSY. <i>AS.MICRO SPORT.V2 RYL UL</i>
	26		12001605	МІКРИК <i>MICROSWITCH</i>
	27		421946000501	2P.CONN.DOOR MICRO V2 RYL UL ASSY. <i>2P.CONN.DOOR MICRO V2 RYL UL ASSY.</i>

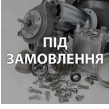
Model Machine

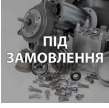
MACSAE199















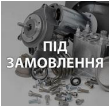











SAECO AULIKA MID (10004471)

	28		1505.014	COFFEEGRINDER SEAL <i>GUARNIZIONE DOSATORE</i>
	29		17001155	GREY COVER FOR DOSER HOLE RYL <i>GREY COVER FOR DOSER HOLE RYL</i>
	30		17000238	COFFEE GRINDER SOUNDPROOFING COVER RYL <i>COFFEE GRINDER SOUNDPROOFING COVER RYL</i>
	31		9161.082	RUBBER COUPLER <i>AGGANCIO IN GOMMA</i>
	32		17000176	BLACK HOPPER FOR POWDER COFFEE RYL <i>BLACK HOPPER FOR POWDER COFFEE RYL</i>
	33		12000450	SCREW TCBR TORX 10 3,5X12 PLAST.ZN-N <i>SCREW TCBR TORX 10 3,5X12 PLAST.ZN-N</i>
	34		0333.008	STEEL GRINDING ADJUSTMENT LEVER <i>STEEL GRINDING ADJUSTMENT LEVER</i>
	35		9991.103	АМОТИЗАТОР ДЛЯ КОФЕМОЛКИ КОФЕМАШИН PHILIPS SAECO 996530... <i>AMMORTIZZATORE PER MACINACAFE</i>
	36		0333.009	BLK GRINDING ADJUST.LEVER HANDGRIP ROYAL <i>BLK GRINDING ADJUST.LEVER HANDGRIP ROYAL</i>
	37		9161.097.150	GREY GROUND COF.DOSER LEVER FIXING PLATE <i>LEVER FIXING PLATE GREY</i>
	38		9161.077.150	DOSE ADJUSTMENT LEVER DE LUXEGREY <i>DOSE ADJUSTMENT LEVER DE LUXE GREY</i>
	39		U201.001	PLAIN WASHER 3,2X9 DIN 7349 GALV. <i>PLAIN WASHER 3,2X9 DIN 7349 GALV.</i>
	40		17000832	GRY COFF.GRINDING/DOSE ADJUST.SCALE RYLO <i>GRY COFF.GRINDING/DOSE ADJUST.SCALE RYLO</i>

Model Machine

MACSAE199

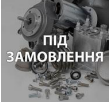











SAECO AULIKA MID (10004471)

	41		149186150	BLACK UPPER GRINDER SUPPORT MAGIC <i>SUPPORT.NER.X MACINA SUPERIO</i>
	42		142844550	UPPER GRINDER COVER COFFEE GRIND. MAGIC <i>UPPER GRINDER COVER COFFEE GRIND. MAGIC</i>
	43	 ПІД ЗАМОВЛЕННЯ	129931002	TORX SCREW T10 TCB 3,5X40 SX ZNG <i>TORX SCREW T10 TCB 3,5X40 SX ZNG</i>
	44		147470763	BLK INCREASE SCREW PIN COF.GRINDER MAGIC <i>PERNO INCREM.A VITE X MACINA</i>
	45		U201.002	PLAIN WASHER 10X16X0,2DIN 988GAL <i>ROSETTA PIANA 10X16X0,2DIN</i>
	46	 ПІД ЗАМОВЛЕННЯ	149188750	CONICAL GRIND. SUPP. + RING MAGIC <i>CONICAL GRIND. SUPP. + RING MAGIC</i>
	47		140360200	FELT RING 40X34X5 <i>ANELLO IN FELTRO DE=40 DI=34</i>
	48		146570950	RING NUT FOR GRINDING ADJUSTMENT MAGIC <i>GHIERA NERA REGOLAZ.MACINATU</i>
	49		128610421	STAIL.STELL AISI 304 SPHERE D=3,2MM <i>SFERA D=3,2MM ACCIAIO INOX A</i>
	50		126770117	NEW SPRING SPHERE D=3,2 MOTORMAGIC <i>MOLLA NEW X SFERA D=3,2 MOTORE MAGIC</i>
	51	 ПІД ЗАМОВЛЕННЯ	9141.080	ТРИМАЧ ДВИГУНА КАВОМОЛКИ ДЛЯ КАВОВАРКИ SAECO 9141.080 <i>SUPPORTO MOTORE</i>
	52		140230400	SHOCK ABS .CONICAL GRINDER SUPP.MAGIC <i>AMMORTIZ.X SUPPOR.MACIN.CONI</i>
	53	 ПІД ЗАМОВЛЕННЯ	9141.042	SAFETY RING <i>SAFETY RING</i>
	54	 ПІД ЗАМОВЛЕННЯ	9141.028	BLACK LOWER GRINDER SUPPORT MAGIC <i>BLACK LOWER GRINDER SUPPORT MAGIC</i>

Model Machine

MACSAE199

SAECO AULIKA MID (10004471)

	55		9141.039	UPPER GRINDER <i>UPPER GRINDER</i>
	56		9141.040	CONICAL GRINDER <i>CONICAL GRINDER</i>
	57		226477700	KIT ITAL MILL GRINDERS <i>COPPIA DI MACINE SAECO CONICHE</i>
	58		128610521	STAIL.STEEL AISI 304 SPHERE D=5,5MM <i>SFERA D=5,5MM ACCIAIO INOX A</i>
	59		126765517	STEEL SPRING SPHERE D=5,5 MOTOR MAGIC <i>MOLLA ACC.X SFERA D=5,5 MOTO</i>
	60		0301.R10.00A	SPARE MOTOR UNIT MC 230V <i>GRUPPO RICAMBIO MOTORE MC 230 V</i>

Model Machine

MACSAE199

SAECO AULIKA MID (10004471)

MACSAE199.T.0008

TAVOLA NR. 8 - ARTICOLO SAECO AULIKA MID (10004471)

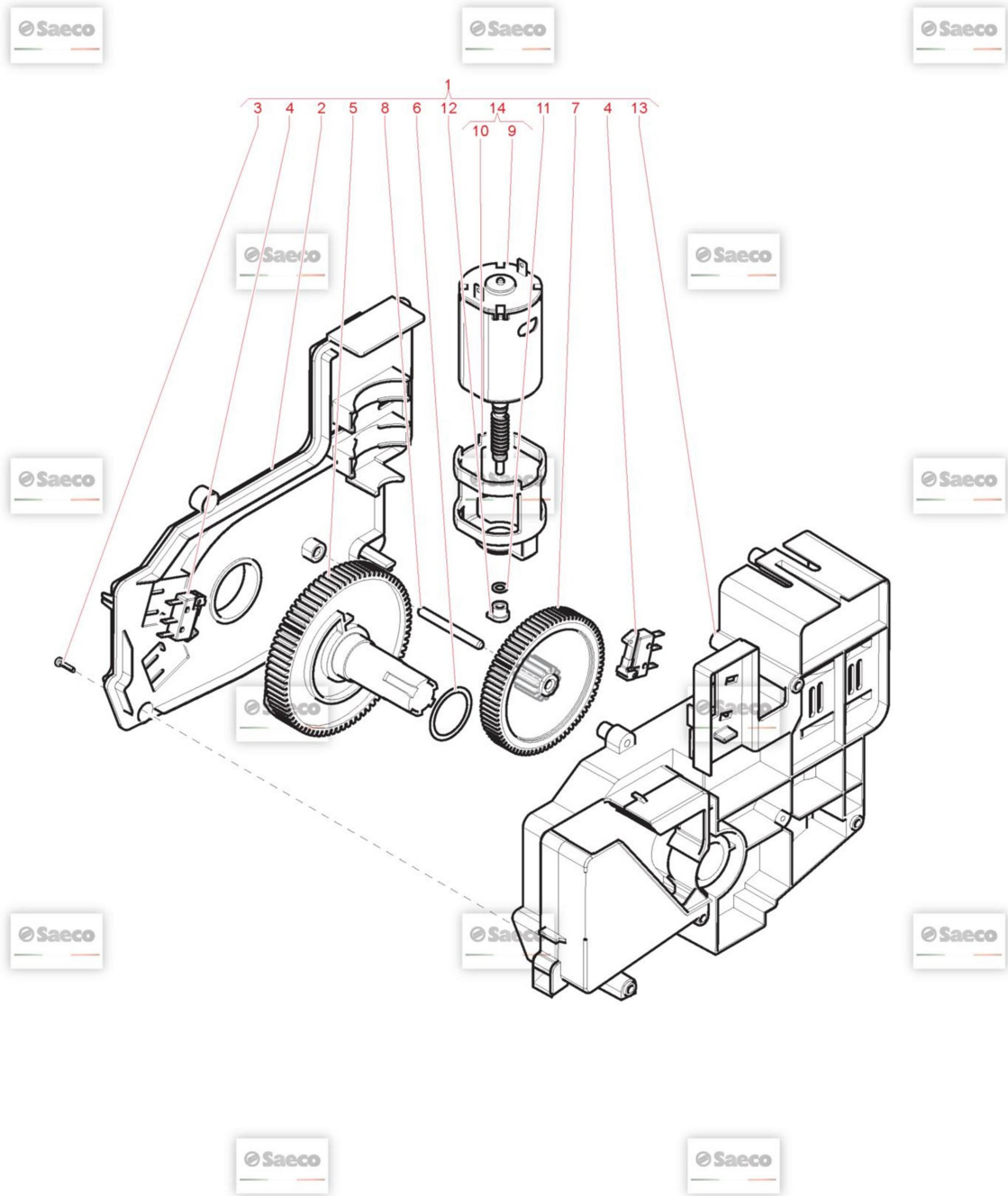

Model Machine

MACSAE199

SAECO AULIKA MID (10004471)

Web Pos. Foto Item - Replace by Description



Press - CTRL + CLICK go to item in a new window
Натисніть - Ctrl + права кнопка миші щоб відкрити запчастину в новому вікні



1



11025736

РЕДУКТОР ВЗБОРИ PHILIPS SAECO 996530068554
RATIOMOTOR RYL ASSY.



2



17000719

GREY RATIOMOTOR LID RYL
GREY RATIOMOTOR LID RYL



3



129670202

TCB PANELVIT SCREW 3,5X16 TESTA D=8 ZNP
TCB PANELVIT SCREW 3,5X16 TESTA D=8 ZNP



4



NE05.038

MICROSWITCH 30V 0.3A
MICROINTERRUTTORE



5

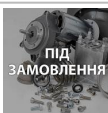

11007137

BLACK GEAR Z=77 V2 FOR RATIOMOTOR P124
BLACK GEAR Z=77 V2 FOR RATIOMOTOR P124



6



9161.368

MYLAR WASHER FOR RATIOMOTOR
RONDELLA MYLAR X MOTORIDUTTORE



7



146002800

GREY GEAR Z=13/90 FOR RATIOMOTOR P124
GREY GEAR Z=13/90 FOR RATIOMOTOR P124



8

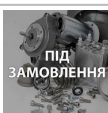

9121.039

STEEL PIN FOR RATIOMOTOR GEARMAGIC
STEEL PIN FOR RATIOMOTOR GEARMAGIC



9

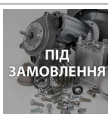

11003037

MOTOR FOR RATIOMOTOR ASSY.
MOTOR FOR RATIOMOTOR ASSY.



10



9121.044

ANTIVIBRATION FOR MOTOR
ANTIVIBRANTE X MOTORE



11



148380200

BAKELIZZATE WASHER D=5,5
BAKELIZZATE WASHER D=5,5



12



9121.046

BRONZE SINTERED BUSH FOR MOTORRATIOMOT.
BRONZE SINTERED BUSH FOR MOTOR RATIOMOT.



13



11026258

GREY RATIOMOTOR CASING WITH TUBE ASSY.
GREY RATIOMOTOR CASING WITH TUBE ASSY.

Model Machine

MACSAE199

SAECO AULIKA MID (10004471)



14



11005214

MOTOR FOR RATIOMOTOR ASSY.

MOTOR FOR RATIOMOTOR P124 ASSY

Model Machine

MACSAE199

SAECO AULIKA MID (10004471)

MACSAE199.T.0009



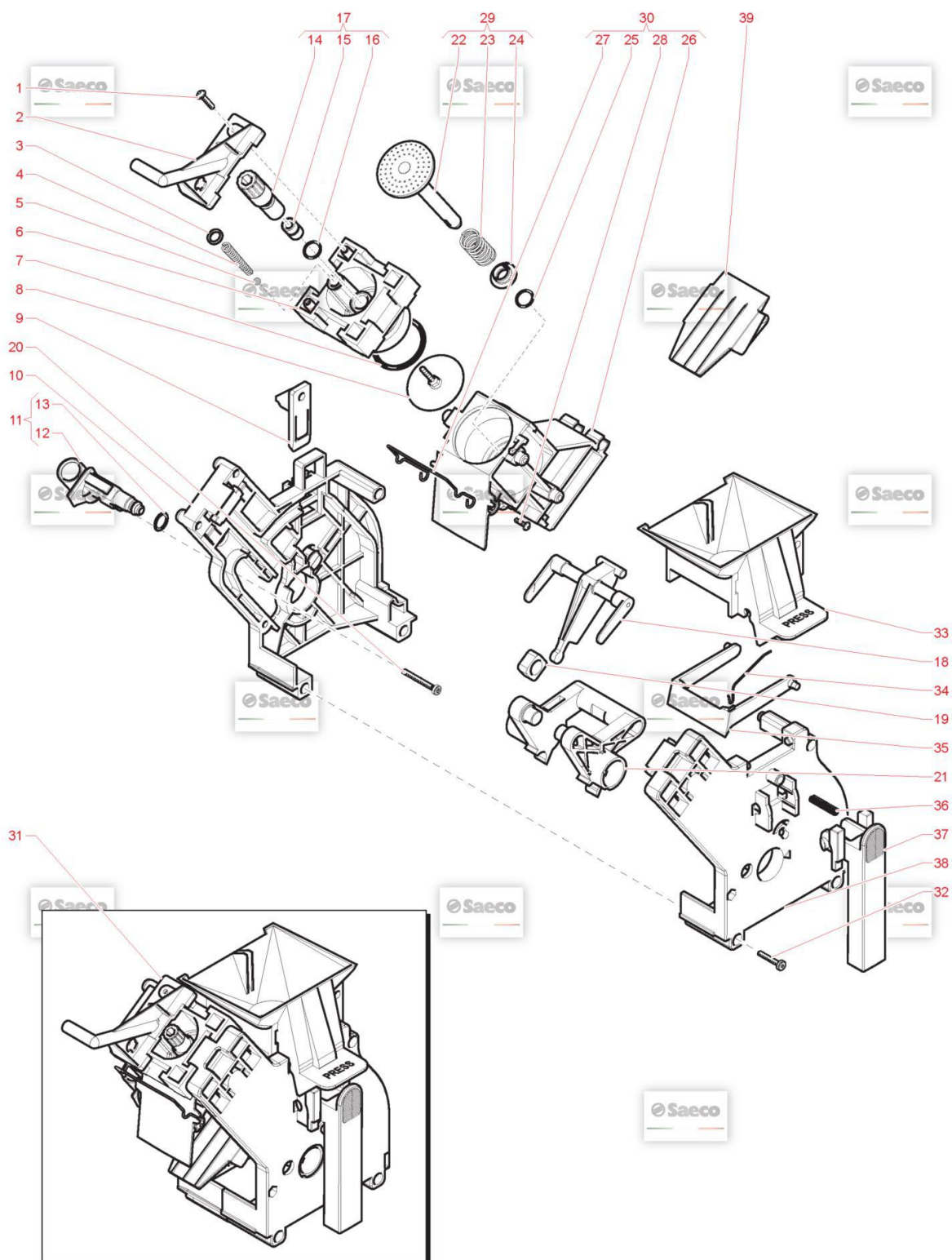























TAVOLA NR. 9 - ARTICOLO SAECO AULIKA MID (10004471)



Model Machine

MACSAE199











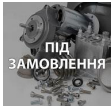

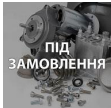











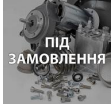

SAECO AULIKA MID (10004471)

Web	Pos.	Foto	Item - Replace by	Description
				<i>Press - CTRL + CLICK go to item in a new window Натисніть - Ctrl + права кнопка миші щоб відкрити запчастину в новому вікні</i>
	1		12002170	SCREW TCB TORX 10 3X16 PLAST SS VITE TCB 3X16 TORX 10 PLAST.INOX
	2		11003789	BLACK COFF.OUTLET SLEEVE BREWUNIT ROYAL BLACK COFF.OUTLET SLEEVE BREW UNIT ROYAL,AULIKA MAGIC SAECO
	3		11021334	BLK COUNTERPISTON SEAL DE=11 DI=8 SP=1,4 BLK COUNTERPISTON SEAL DE=11 DI=8 SP=1,4
	4		9161.222	SS.CONICAL SPRING MOLLA CONICA
	5	 ПІД ЗАМОВЛЕННЯ	421944034451	BOROSILICATE SPHERE D.5 MM BOROSILICATE SPHERE D.5
	6		11003796	BLACK BREW UNIT COUNTERPISTONM5000 BLACK BREW UNIT COUNTERPISTON M5000
	7		NM01.044	OR ORM 0320-40 SILICONE PTFE/FDA OR ORM 0320-40 SILICONE PTFE
	8		9160.075	PERCOLATOR DE=35,8 ELFO ASSY. PERCOLATOR DE=35,8 ELFO ASSY.
	9	 ПІД ЗАМОВЛЕННЯ	11004114	BLACK BREW UNIT COUPLING PLATE BLACK BREW UNIT COUPLING PLATE
	10	 ПІД ЗАМОВЛЕННЯ	421941158532	BLACK BREW UNIT REAR PLATE V2M5000 BLACK BREW UNIT REAR PLATE V2 M5000
	11		20000440	BLACK WATER INLET SLEEVE BREWUNIT ASSY. BLACK WATER INLET SLEEVE BREW UNIT ASSY.
	12		9161.064.050	BLACK WATER INLET SLEEVE BREWUNIT ROYAL BLACK WATER INLET SLEEVE BREW UNIT ROYAL
	13		NM02.007	OR 2025 IN TERMOIL OR 2025 TERMOIL

Model Machine

MACSAE199













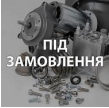









SAECO AULIKA MID (10004471)

	14		147472650	PIN BLACK FOR PERCOLATOR <i>PIN BLACK FOR PERCOLATOR</i>
	15		NF11.067	BRASS INSERT FOR PERCOLATOR LOCKING PIN <i>BRASS INSERT FOR PERCOLATOR LOCKING PIN</i>
	16		140324461	OR ORM 0060-20 TERMOIL <i>OR ORM 0060-20 IN TERMOIL</i>
	17		227470150	PIN BLACK ASS.FOR PERCOLATOR <i>PIN BLACK ASS.FOR PERCOLATOR</i>
	18		11003078	BLACK CONNECTING ROD BREW UNIT8GR. <i>BLACK CONNECTING ROD BREW UNIT 8GR.</i>
	19		9161.094.050	BLACK BREW UNIT DRILLED BLOCK <i>BLACK BREW UNIT DRILLED BLOCK</i>
	20		12000550	CAMOPI3 TCB TORX 10 3X25 PLAST.SS <i>SCREW TCB TORX 10 3X25 PLAST.SS</i>
	21		9161.066.050	BLACK BREW UNIT ELBOW SHAFT M5000 <i>BLACK BREW UNIT ELBOW SHAFT M5000</i>
	22		11003077	BLK BREW UNIT INTEGRAL PISTON8GR.ASSY. <i>BLK BREW UNIT INTEGRAL PISTON 8GR.ASSY.</i>
	23		9161.198	SS.8GR.BREW UNIT PISTON SPRING <i>SS.8GR.BREW UNIT PISTON SPRING</i>
	24		9161.191	WHITE 8GR.-12GR.BREW UNIT PISTON BUSH <i>BOCCOLA X PISTONE NEUTRO</i>
	25		NM02.018	OR ORM 0090-25 TERMOIL <i>OR ORM 0090-25 TERMOIL</i>
	26		421944014611	BLK COF.CONTAIN.BREW UNIT V2 M5000 ASSY. <i>BLK COF.CONTAIN.BREW UNIT V2 M5000 ASSY.</i>
	27		11001556	SS BREW UNIT SPRING H=49 SMART <i>SS BREW UNIT SPRING H=49 SMART</i>

Model Machine

MACSAE199

SAECO AULIKA MID (10004471)

	28		129912521	SCREW TCBR TORX 10 3,5X14 PLAST.SS SCREW TCBR TORX 10 3,5X14 PLAST.SS
	29		11023086	BLK 8GR.BREW UNIT NTEGR.PISTONGEN.ASSY. BLK 8GR.BREW UNIT NTEGR.PISTON GEN.ASSY.
	30		11004570	BLACK BREW UNIT COFFEE CONT.P124 ASSY. AS.CONT.CAF.GRUP.8G.P124 NER.
	31		11031584	BLACK BREW UNIT BLACK BREW UNIT RYL
	32		12000897	SCREW TCB TORX 10 3,5X20 PLAST.SS SCREW TCB TORX 10 3,5X20 PLAST.SS
	33		11003795	BLACK HOPPER COFF.BREW UNIT S/SCR.M5000 BLACK HOPPER COFF.BREW UNIT S/SCR.M5000
	34		9161.046	ПРУЖИНА ВОРОНКИ ЗАВАРОЧНОГО БЛОКА ДЛЯ КОФЕМАШИН PHILIPS ... MOLLA X RASATORE GRUPPO
	35		11004161	BLACK SCRAPER FOR BREW UNIT M5000 BLACK SCRAPER FOR BREW UNIT M5000
	36		11003793	BLACK BREW UNIT FRONT PLATE M5000 BLACK BREW UNIT FRONT PLATE M5000
	37		9161.045	SS BREW UNIT HANDGRIP SPRING M5000 MOLLA X IMPUGNATURA GRUPPO
	38		11003791	BLACK BREW UNIT HANDGRIP M5000 BLACK BREW UNIT HANDGRIP M5000
	39		17000663	BLACK BREW UNIT CONVEYOR SLIDEL=76,8 BLACK BREW UNIT CONVEYOR SLIDE L=76,8

Model Machine

MACSAE199

SAECO AULIKA MID (10004471)

MACSAE199.T.0010

TAVOLA NR. 10 - ARTICOLO SAECO AULIKA MID (10004471)

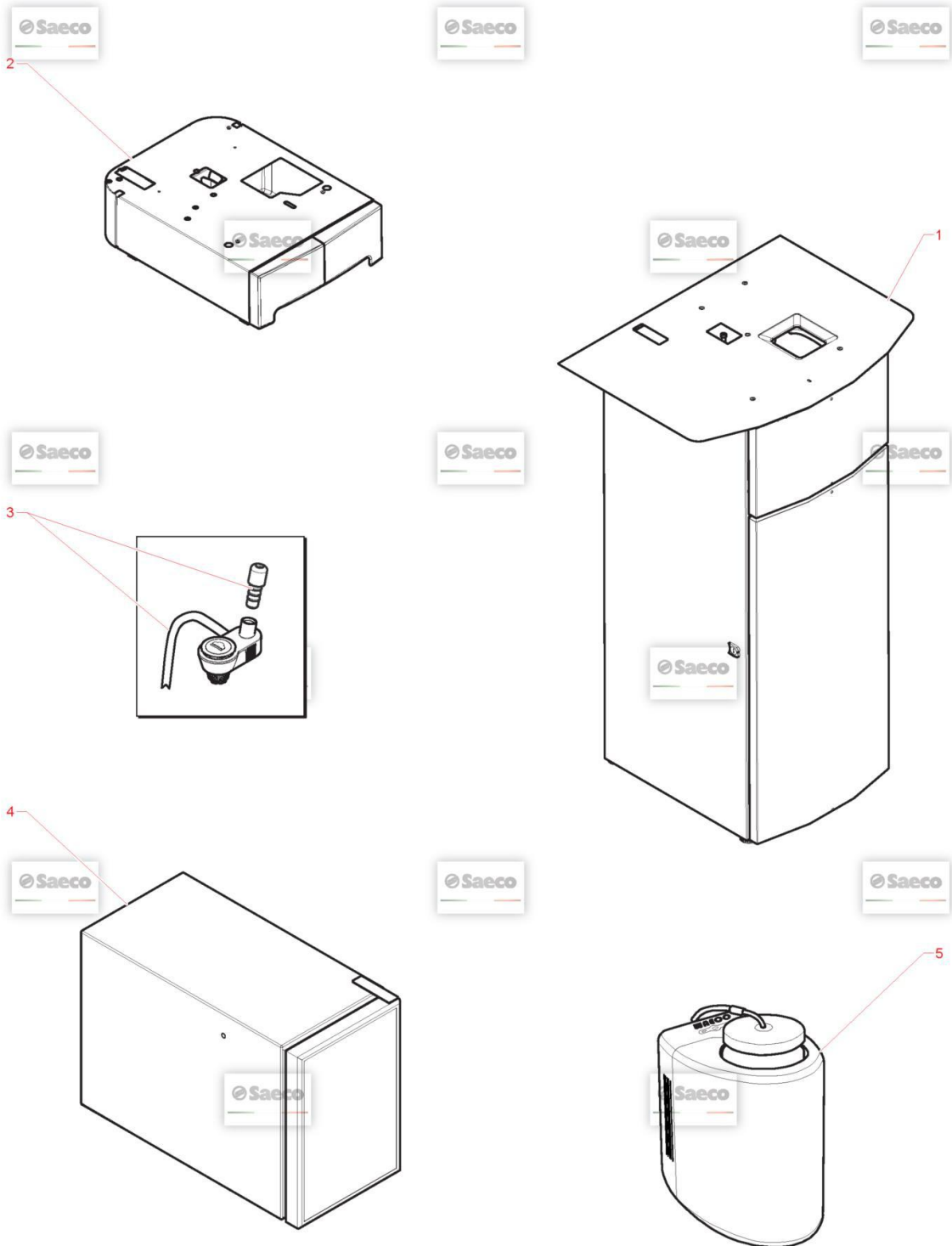

Model Machine

MACSAE199

SAECO AULIKA MID (10004471)

Web Pos. Foto Item - Replace by Description



*Press - CTRL + CLICK go to item in a new window
Натисніть - Ctrl + права кнопка миші щоб відкрити запчастину в новому вікні*



1

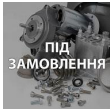

10005004

VE CABINET AULIKA-ROYAL-AMBRABLK-SIL
VE CABINET AULIKA-ROYAL-AMBRABLK-SIL



2

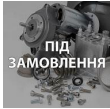

21002181

OCS KIT EXTRA CAPACITY AULIKABLK
OCS KIT EXTRA CAPACITY AULIKA BLK



3

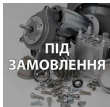

20007320

KIT 2 CAPPUCCINATORE THUNDER SMR/H
KIT 2 CAPPUCCINATORE THUNDER SMR/H



4

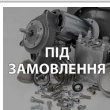

21001800

ACC PR FRIGO ASTRA 220/230 50/60 SCH BLK
ACC PR FRIGO ASTRA 220/230 50/60 SCH BLK



5

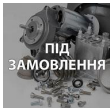

21001820

ACC PR MANTENITORE 100/240V 50-60HZ BLK
ACC PR MANTENITORE 100/240V 50-60HZ BLK