

# Model Machine

MACSAE156

AULIKA FOCUS (10004472)

MACSAE156.T.0001



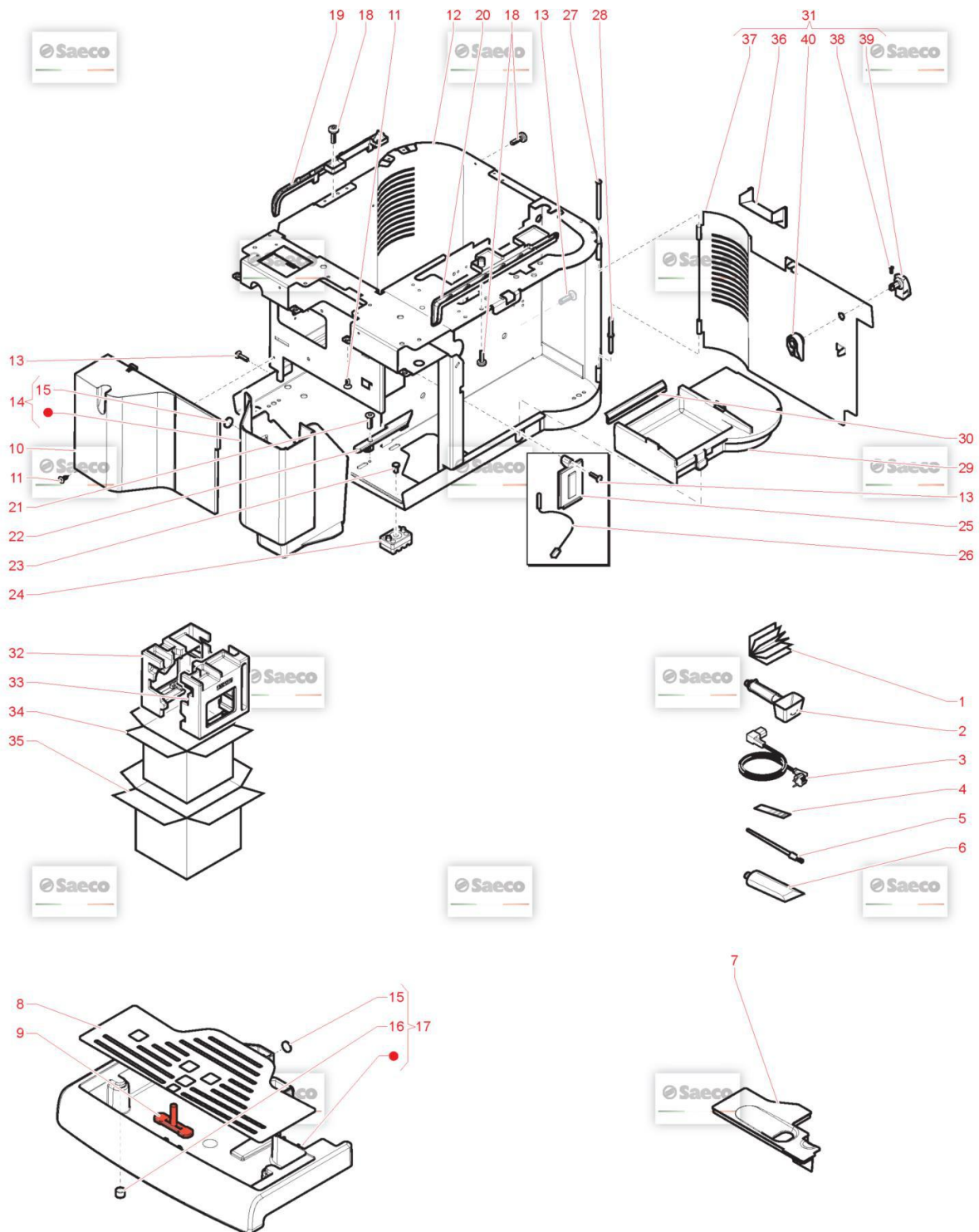









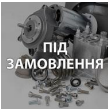

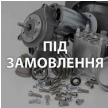

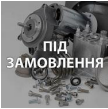

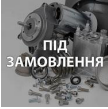

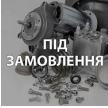

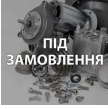

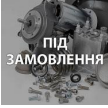
TAVOLA NR. 1 - ARTICOLO AULIKA FOCUS ( 10004472 )

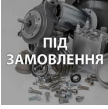

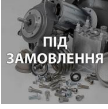
## Model Machine

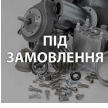
MACSAE156

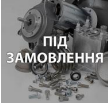

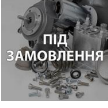







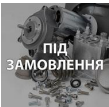

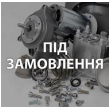

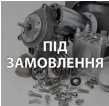











AULIKA FOCUS (10004472 )

Web	Pos.	Foto	Item - Replace by	Description
				<i>Press - CTRL + CLICK go to item in a new window</i> <i>Натисніть - Ctrl + права кнопка миші щоб відкрити запчастину в новому вікні</i>
	1		11035722	EXTRA SHEET SAGA FOR SAECO <i>EXTRA SHEET SAGA FOR SAECO</i>
	1		15003172	GUARANTEE SHEET PSA USA/CAN/MEX <i>GUARANTEE SHEET PSA USA/CAN/MEX</i>
	1		15003897	DECLARATION OF CONFORMITY RYLOSAE <i>DECLARATION OF CONFORMITY RYLOSAE</i>
	1		15004727	HARMONIZATION EXTRA SHEET FOCUS <i>HARMONIZATION EXTRA SHEET FOCUS</i>
	1		421940439951	MANUAL SAE SUP040 RYLO/P IT <i>MANUAL SAE SUP040 RYLO/P IT</i>
	1		421940439961	MANUAL SAE SUP040 RYLO/P GB <i>MANUAL SAE SUP040 RYLO/P GB</i>
	1		421940439971	MANUAL SAE SUP040 RYLO/P DE <i>MANUAL SAE SUP040 RYLO/P DE</i>
	1		421940439981	MANUAL SAE SUP040 RYLO/P FR <i>MANUAL SAE SUP040 RYLO/P FR</i>
	1		421940439991	MANUAL SAE SUP040 RYLO/P ES <i>MANUAL SAE SUP040 RYLO/P ES</i>
	1		421944015731	MANUAL SAE SUP040 RYLO/P KOR <i>MANUAL SAE SUP040 RYLO/P KOR</i>
	1		421944050682	REGISTRATION CARD 2017 USA <i>REGISTRATION CARD 2017 USA</i>
	1		421946001381	WARNING SHEET USA GB/F <i>WARNING SHEET USA GB/F</i>

## Model Machine

MACSAE156













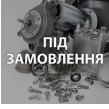



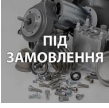



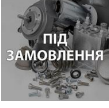





AULIKA FOCUS (10004472 )

	1		<b>421946032091</b>	MANUAL SAE R19848 RYL/T GB <i>MANUAL SAE R19848 RYL/T GB</i>
	1		<b>421946032101</b>	MANUAL SAE R19848 RYL/T FR <i>MANUAL SAE R19848 RYL/T FR</i>
	1		<b>421946032111</b>	MANUAL SAE R19848 RYL/T ES <i>MANUAL SAE R19848 RYL/T ES</i>
	2		<b>421944033301</b>	BLK ABS COFFEE MEASURE SMART <i>BLK ABS COFFEE MEASURE SMART</i>
	3		<b>11001985</b>	BLACK POWER CABLE KOREA L=1200 <i>BLACK POWER CABLE KOREA L=1200</i>
	3		<b>17800024</b>	BLACK POWER CABLE JAPPON VCTFL=1200MM <i>BLACK POWER CABLE JAPPON VCTF L=1200MM</i>
	3		<b>183911050</b>	ЧОРНИЙ КАБЕЛЬ SCHUKO L=1200 SAECO <i>BLACK POWER CABLE SCHUKO L=1200</i>
	3		<b>183921950</b>	POWER CABLE SJT3 USA BLACK ULL=1200 <i>POWER CABLE SJT3 USA BLACK UL L=1200</i>
	3		<b>183940650</b>	BLACK POWER CABLE AUSTRALIA L=1200 <i>BLACK POWER CABLE AUSTRALIA L=1200</i>
	3		<b>NE01.093</b>	CABLE ARGENTINA + PLUG EN60320C13 <i>CABLE ARGENTINA + PLUG EN60320 C13</i>
	4		<b>0301.961</b>	STICKER FOR WATER HARDNESS TEST <i>TEST DUREZZA ACQUA</i>
	5		<b>421946017941</b>	KLUBERLUB NH1 11-222 TUBE 5GR. <i>PSA KLUBER TRIBOSTAR SIL 2 TUBE 5GR.</i>
	7		<b>17000982</b>	BLACK DRIP TRAY COVER RYL <i>BLACK DRIP TRAY COVER RYL</i>
	8		<b>17000183</b>	BA/SS DRIP TRAY GRATE RYL/T <i>BA/SS DRIP TRAY GRATE RYL/T</i>

## Model Machine

MACSAE156

















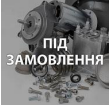







AULIKA FOCUS (10004472 )

	9		17000991	RED FLOAT V2 FOR DRIP TRAY RYL <i>RED FLOAT V2 FOR DRIP TRAY RYL</i>
	10	 ПІД ЗАМОВЛЕННЯ	11025728	GLOSS/SPEC.FRONT CASING COVER RYL/T <i>GLOSS/SPEC.FRONT CASING COVER RYL/T</i>
	11		129535721	SCREW TSP TORX 10 AB 3,5X9,5 SHEET SS <i>SCREW TSP TORX 10 AB 3,5X9,5 SHEET SS</i>
	12	 ПІД ЗАМОВЛЕННЯ	11025722	LIGHT/GREY STEEL CASING RYL/T ASSY. <i>LIGHT/GREY STEEL CASING RYL/T ASSY.</i>
	13		12000450	SCREW TCB TORX 10 3,5X12 PLAST.ZN-N <i>SCREW TCB TORX 10 3,5X12 PLAST.ZN-N</i>
	14	 ПІД ЗАМОВЛЕННЯ	11025729	GLOSS/SPEC.DUMP BOX RYL ASSY. <i>GLOSS/SPEC.DUMP BOX RYL ASSY.</i>
	15		9991.093	MAGNET D=9,5 X H=1,5 <i>MAGNETE D.9,5 X 1,5</i>
	16		9161.111	MAGNET FOR FLOAT SUPERAUT. <i>MAGNET FOR FLOAT SUPERAUT.</i>
	17	 ПІД ЗАМОВЛЕННЯ	11025730	GLOSS/SPEC.DRIP TRAY RYL ASSY. <i>GLOSS/SPEC.DRIP TRAY RYL ASSY.</i>
	18		12001622	SCREW TCB TORX B 3,5X9,5 SCHEET NIK <i>SCREW TCB TORX B 3,5X9,5 SCHEET NIK</i>
	19	 ПІД ЗАМОВЛЕННЯ	17002048	GREY CASING LEFT CLOSING INSERT RYLO/T <i>GREY CASING LEFT CLOSING INSERT V2 RYL</i>
	20	 ПІД ЗАМОВЛЕННЯ	17000426	GREY CASING RIGHT CLOSING INSERT RYL <i>GREY CASING RIGHT CLOSING INSERT RYL</i>
	20		17001369	GREY CASING RIGHT CLOSING INSERT V2 RYL <i>GREY CASING RIGHT CLOSING INSERT V2 RYL</i>
	21		12000895	SCREW TSP TORX 10 3X10 PLAST.SS <i>SCREW TSP TORX 10 3X10 PLAST.SS</i>

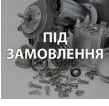
## Model Machine

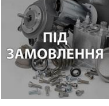
MACSAE156

AULIKA FOCUS (10004472 )

	22		17000723	GREY DUMP BOX GUIDE RYL <i>GREY DUMP BOX GUIDE RYL</i>
	23		11021769	BLACK RIGID FOOT FIXING PIN MYB9 <i>BLACK RIGID FOOT FIXING PIN MYB9</i>
	24		11021829	ФІКСУЮЧИЙ НІС НИЖНІЙ ЧАСТИНИ КОРПУСУ (НІЖКИ) PHILIPS SAECO 9... <i>BLACK/TRANSP.RIGID FOOT MYB9</i>
	25		17000240	GREY MOUNTING PLATE INSERT RYL <i>GREY MOUNTING PLATE INSERT RYL</i>
	26		17800442	2POLES CONNECT.SENSOR REED DUMP BOX CST <i>2POLES CONNECT.SENSOR REED DUMP BOX CST</i>
	27		0301.019	NIK/BRASS PIN FOR DOOR SUPERAUT. <i>NIK/BRASS PIN FOR DOOR SUPERAUT.</i>
	28		0301.020	NIK/BRASS PIN FOR DOOR SUPERAUT. <i>NIK/BRASS PIN FOR DOOR SUPERAUT.</i>
	29		0301.041.150	GREY BREW UNIT SUPPORT PLATE ROYAL <i>PIASTRA SUPPORTO GRUPPO GRIGIO</i>
	30		9161.140	SEAL FOR UNIT PLATE <i>GUARNIZIONE X PIASTRA GRUPPO</i>
	31		11025727	LIGHT/GREY STEEL CASING DOOR RYL ASSY. <i>LIGHT/GREY STEEL CASING DOOR RYL ASSY.</i>
	31		11029564	LIGHT/GREY STEEL CASING DOOR RYL UL ASSY <i>LIGHT/GREY STEEL CASING DOOR RYL UL ASSY</i>
	32		13001330	INS.SX SCATOLA RYL PS-E <i>INS.SX SCATOLA RYL PS-E</i>
	33		13001319	PS-E RIGHT INSERT FOR BOX RYL <i>PS-E RIGHT INSERT FOR BOX RYL</i>

## Model Machine

MACSAE156

AULIKA FOCUS (10004472 )



34

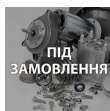

13001640

WHITE BOX RYL/T SAE ROYAL ONETOUCH CEE  
*WHITE BOX RYL/T SAE ROYAL ONE TOUCH CEE*



35



421946001171

WHT EXTERNAL BOX RYLO/P SAE 27L.  
*WHT EXTERNAL BOX RYLO/P SAE 27L.*



36

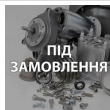

11027680

7021/GREY DOOR COVER S/SCR.RYL  
*7021/GREY DOOR COVER S/SCR.RYL*



37

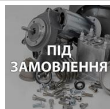

11025758

LIGHT/GREY STEEL CASING DOOR RYL  
*LIGHT/GREY STEEL CASING DOOR RYL*



37



11029563

LIGHT/GREY STEEL CASING DOOR RYL UL  
*LIGHT/GREY STEEL CASING DOOR RYL*



38



U433.001

NAIL 2X6 UNI 7591 BURN.  
*NAIL 2X06 UNI 7591 BURN.*



39



0301.039.150

7015/GREY DOOR CLOSURE KNOB  
*7015/GREY DOOR CLOSURE KNOB*



40



0301.040.150

GREY DOOR CLOSURE LEVER  
*GREY DOOR CLOSURE LEVER*

# Model Machine

MACSAE156

AULIKA FOCUS (10004472 )

MACSAE156.T.0002

TAVOLA NR. 2 - ARTICOLO AULIKA FOCUS ( 10004472 )

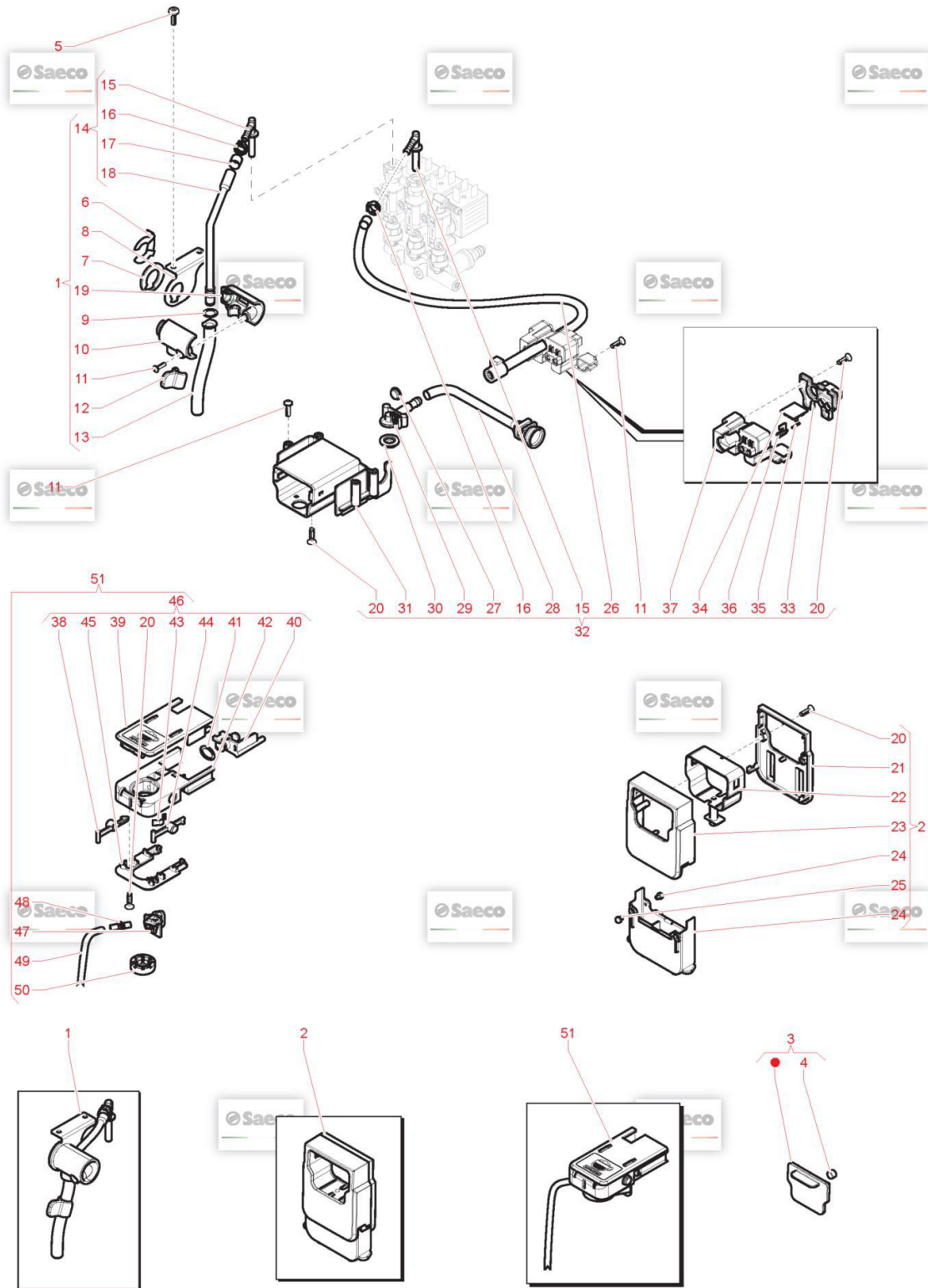

## Model Machine

MACSAE156

AULIKA FOCUS (10004472 )

Web Pos. Foto Item - Replace by Description



*Press - CTRL + CLICK go to item in a new window  
Натисніть - Ctrl + права кнопка миші щоб відкрити запчастину в новому вікні*



1



11031416

ХРОМОВАНА ТРУБКА ДЛЯ ВОДИ/ПАРУ V3  
TF/CHROM.STEAM TUBE V3 RYL/T ASSY.



2



11025731

GLOSS/SPEC.COFFEE DISPENSER RYL ASSY.  
GLOSS/SPEC.COFFEE DISPENSER RYL ASSY.



3

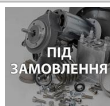

11025753

GLOSS/SPEC.FRON.COF.DISP.COVERRYL/T ASS  
GLOSS/SPEC.FRON.COF.DISP.COVER RYL/T ASS



4



9161.111

MAGNET FOR FLOAT SUPERAUT.  
MAGNET FOR FLOAT SUPERAUT.



5



12001622

SCREW TCB TORX B 3,5X9,5 SCHEET NIK  
SCREW TCB TORX B 3,5X9,5 SCHEET NIK



6



NF11.084

PHOSPH/STEEL FOLK SPRING  
PHOSPH/STEEL FOLK SPRING



7



11001624

BLACK STEAM TUBE WASHER P0049  
BLACK STEAM TUBE WASHER P0049



8

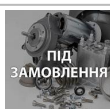

17000815

STEEL STEAM TUBE SUPPORT BRACKET RYL  
STEEL STEAM TUBE SUPPORT PLATE RYL



9



140321961

ПРОКЛАДКА O-RING ДЛЯ КАВОМАШИНИ SAECO 2031 TERMOIL  
OR 2031 IN TERMOIL



10

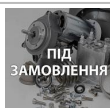

17001437

BLACK FRONT STEAM TUBE SUPPORTRYL  
BLACK FRONT STEAM TUBE SUPPORT RYL



11



12000450

SCREW TCB TORX 10 3,5X12 PLAST.ZN-N  
SCREW TCB TORX 10 3,5X12 PLAST.ZN-N



12

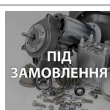

17001574

BLACK STEAM TUBE HANDGRIP RYLO  
BLACK STEAM TUBE HANDGRIP RYLO



13

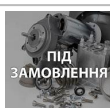

11025760













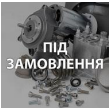











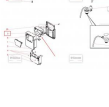

TF/CHROM.STEAM TUBE RYL  
TF/CHROM.STEAM TUBE RYL



## Model Machine

MACSAE156























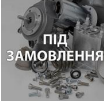

AULIKA FOCUS (10004472 )

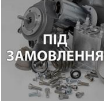
	14		<b>20007030</b>	BLACK OUTPUT STEAM TUBE KIT RYL <i>BLACK OUTPUT STEAM TUBE KIT RYL</i>
	15		<b>17002197</b>	BLACK CAPPUCIN/STEAM TUBE CONNECT.V4 RYL <i>BLACK CAPPUCIN/STEAM TUBE CONNECT.V4 RYL</i>
	16		<b>12000892</b>	ЗАЖИМ D.9,5 16700004 <i>OETIKER CLAMP D=9,5 16700004 ( L250 )</i>
	17		<b>11025683</b>	BLACK TUBE DI=9,5 SP=0,30 L=10 <i>BLACK TUBE DI=9,5 SP=0,30 L=10</i>
	18		<b>11022989</b>	BLACK SILIC.STEAM DISPENSER TUBE MDS <i>TUBO EROG.VAP.MDS SILIC.NER.</i>
	19		<b>17000672</b>	BLACK REAR STEAM TUBE SUPPORTRYL <i>BLACK REAR STEAM TUBE SUPPORT RYL</i>
	20		<b>12000895</b>	SCREW TSP TORX 10 3X10 PLAST.SS <i>SCREW TSP TORX 10 3X10 PLAST.SS</i>
	21		<b>17000248</b>	BLACK REAR COVER COFFEE DISPENSER RYL <i>BLACK REAR COVER COFFEE DISPENSER RYL</i>
	22		<b>17000251</b>	BLACK INNER BODY COFFEE DISPENS.RYL <i>BLACK INNER BODY COFFEE DISPENS.RYL</i>
	23		<b>11025756</b>	GLOSS/SPEC.FRONT COF.DISPENSERCOVER RYL <i>GLOSS/SPEC.FRONT COF.DISPENSER COVER RYL</i>
	24		<b>11013085</b>	WHITE COFFEE DISPENSER SLIDERMYB9 <i>WHITE COFFEE DISPENSER SLIDER MYB9</i>
	25		<b>17000246</b>	ЧОРНА ЗАГЛУШКА ЧАСТИНИ КАВОВОГО ДІСПЕНСОРА <i>BLACK EXT.MOBILE PART COF.DISPENSER RYL</i>
	26		<b>20007031</b>	BLK CAPPUC.OUTPUT STEAM CONNECT.KIT RYL <i>BLK CAPPUC.OUTPUT STEAM CONNECT.KIT RYL</i>
	27		<b>11014016</b>	SS.INSERT FOR MAGNET MYB9 <i>SS.INSERT FOR MAGNET MYB9</i>

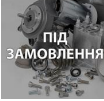
## Model Machine

MACSAE156



















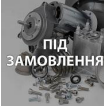

AULIKA FOCUS (10004472 )

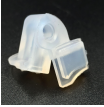
	28		17000614	BLACK DISPENSER COFF.INLET CONNECT.RYL <i>BLACK DISPENSER COFF.INLET CONNECT.RYL</i>
	29		17000616	BLACK COFFEE DISPENSER TUBE RYL <i>BLACK COFFEE DISPENSER TUBE RYL</i>
	30		17000337	BLACK SEAL FOR COFFEE DISPENSER RYL <i>BLACK SEAL FOR COFFEE DISPENSER RYL</i>
	31		17000257	BLACK.COFFEE DISPENSER SUPPORTRYL <i>BLACK.COFFEE DISPENSER SUPPORT RYL</i>
	32		11031417	BLK TEA/BR.COF.DISPENS.SUPP.V3RYL/T ASS <i>AS.SUPP.EROG.CAF.V3 RYL/T OT/TEA NER.</i>
	33		17000348	BLK CAPPUCINATORE BOARD SUPP.COVER RYL <i>BLK CAPPUCINATORE BOARD SUPP.COVER RYL</i>
	34		11025772	CAPPUCINATORE BOARD RYL <i>CAPPUCINATORE BOARD RYL</i>
	35		17000019	SS CARAFE MICRO INSERT SPRINGMYB9 <i>SS CARAFE MICRO INSERT SPRING MYB9</i>
	36		17000421	BLACK CAPPUCINATORE PRESENCEINSERT RYL <i>BLACK CAPPUCINATORE PRESENCE INSERT RYL</i>
	37		17000339	BLACK CAPPUCINATORE BOARD SUPPORT RYL <i>BLACK CAPPUCINATORE BOARD SUPPORT RYL</i>
	38		17000389	ЛІВА ЗАЩІПКА КАПУЧИНАТОРА <i>GREY LEFT CAPPUCINATORE INSERT RYL</i>
	39		17004098	BLK UPPER CAPPUC.LID LASER.RYL <i>BLK UPPER CAPPUC.LID LASER.RYL</i>
	40		17000785	BLACK CAPPUC.INPUT MILK CONNECTOR RYL <i>BLACK CAPPUCINATORE MILK CONNECTOR RYL</i>

## Model Machine

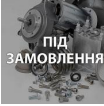
MACSAE156

AULIKA FOCUS (10004472 )

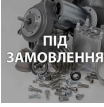
	41		NM01.028	O-RING 106 SILICONE OR 106 SILICONE
	42		17000338	BLACK LEFT ENTRY CAPPUCCINAT.CASING RYL BLACK LEFT ENTRY CAPPUCCINAT.CASING RYL
	43	 ПІД ЗАМОВЛЕННЯ	17000382	SS CAPPUCCINATORE INSERT SPRING RYL SS CAPPUCCINATORE INSERT SPRING RYL
	44		17000402	GREY RIGHT CAPPUCCINATORE INSERT RYL GREY RIGHT CAPPUCCINATORE INSERT RYL
	45		421941278272	НИЖНЯ СТІНКА КАПУЧИНАТОРА V2 RYL BLK LOWER CAPPUCCINATORE LID V2 RYL
	46	 ПІД ЗАМОВЛЕННЯ	421941260042	КОРПУС КАПУЧИНАТОРА SAECO BLK CAPPUCCINATORE S/SCR.V2 RYLO ASSY
	47		17000336	MILK INTAKE TUBE CONNECTOR RYL MILK INTAKE TUBE CONNECTOR RYL
	48		17001362	BLK MILK INTAKE TUBE CONNECT.INS.V2 RYL BLK MILK INTAKE TUBE CONNECT.INS.V2 RYL
	49	 ПІД ЗАМОВЛЕННЯ	229363500	SILICONE TUBE 3,5X6 L=400 MM SILICONE TUBE 3,5X6 L=400 MM
	50		17000486	BLK CAPPUCCIN.OUTPUT MILK CONNECTOR RYL BLK CAPPUCCIN.OUTPUT MILK CONNECTOR RYL
	51	 ПІД ЗАМОВЛЕННЯ	11025751	КАПУЧИНАТОР AULICA FOCUS BLACK CAPPUCCINATORE S/SCR.RYL ASSY.

# Model Machine

MACSAE156

AULIKA FOCUS (10004472 )

MACSAE156.T.0003

TAVOLA NR. 3 - ARTICOLO AULIKA FOCUS ( 10004472 )

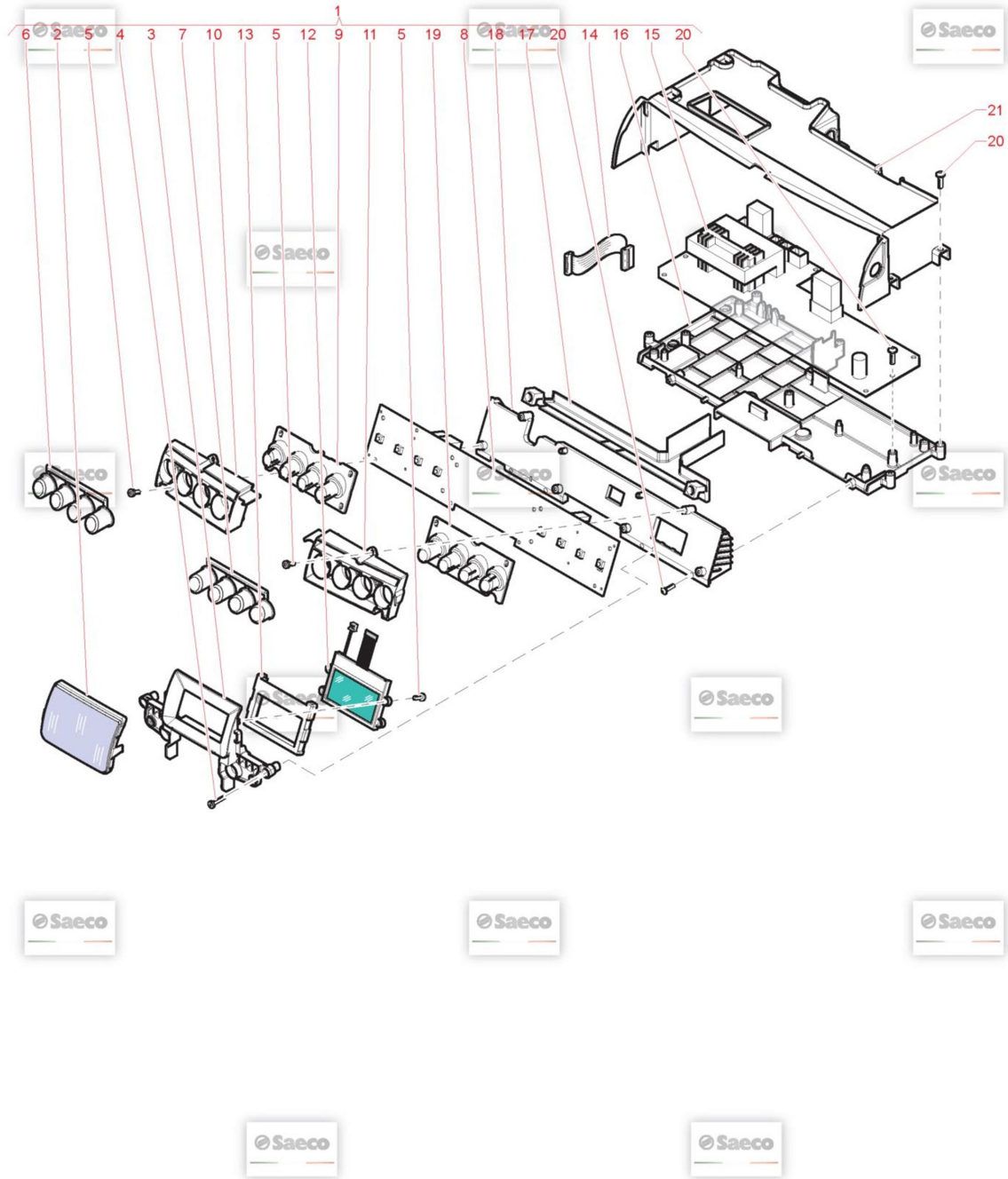

## Model Machine

MACSAE156

AULIKA FOCUS (10004472 )

Web Pos. Foto Item - Replace by Description



*Press - CTRL + CLICK go to item in a new window  
Натисніть - Ctrl + права кнопка миші щоб відкрити запчастину в новому вікні*



1

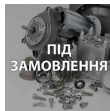

11028828

ELECTR.PARTS 120V UL RYL/T ASSY.  
*ELECTR.PARTS 120V UL RYL/T ASSY.*



1

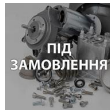

421941304781

ELECTR.PARTS 230V RYLO/P ASSY.  
*AS.PARTI EL.RYLO/P 230V*



1

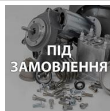

421946018151

ELECTR.PARTS 100V RYLO/P ASSY.  
*ELECTR.PARTS 100V RYLO/P ASSY.*



1



421946021601

ELECTR.PARTS 120V RYLO/P ASSY.  
*ELECTR.PARTS 120V RYLO/P ASSY.*



2



17000269

СКЛО ДИСПЛЕЯ PHILIPS SAECO 996530068575  
*TRANSP.GLASS FOR DISPLAY RYL*



3



17000259

BLACK DISPLAY INSERT RYL  
*BLACK DISPLAY INSERT RYL*



4

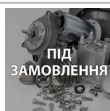

129914002

SCREW TCB TORX 10 3,5X16 PLAST.ZN-B  
*SCREW TCB TORX 10 3,5X16 PLAST.ZN-B*



5

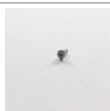

129913202

SCREW TCB TORX 10 3X8 PLAST.ZN-B  
*SCREW TCB TORX 10 3X8 PLAST.ZN-B*



6

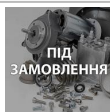

17001837

BLK LEFT TOUCH PANEL COVER V2S/S.RYL/T  
*BLK LEFT TOUCH PANEL COVER V2 S/S.RYL/T*



7

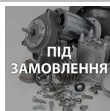

17001310

BLK RIGHT TOUCH PANEL COVER V2S/S.RYL/T  
*BLK RIGHT TOUCH PANEL COVER V2 S/S.RYL/T*



8

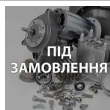

11024659

CPU+SW RYL ASSY.  
*CPU+SW RYL ASSY.*



8



421941302571

CPU+SW RYLO/P ASSY. 230V  
*CPU+SW RYLO/P ASSY. 230V*



8

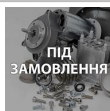











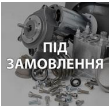

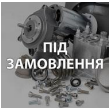













421941307841

CPU+SW AS. AULIKA FOCUS V2 100V  
*CPU+SW AS. AULIKA FOCUS V2 100V*

## Model Machine

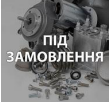
MACSAE156

AULIKA FOCUS (10004472 )

	9	 ПІД ЗАМОВЛЕННЯ	<b>17000434</b>	TRANSP.LEFT TOUCH PANEL RYL <i>TRANSP.LEFT TOUCH PANEL RYL</i>
	10	 ПІД ЗАМОВЛЕННЯ	<b>17000488</b>	BLACK LEFT TOUCH PANEL SUPPORTRYL <i>BLACK LEFT TOUCH PANEL SUPPORT RYL</i>
	11	 ПІД ЗАМОВЛЕННЯ	<b>17000244</b>	BLACK RIGHT TOUCH PANEL SUPPORT RYL <i>BLACK RIGHT TOUCH PANEL SUPPORT RYL</i>
	12		<b>12001606</b>	ДІСПЛЕЙ 160X80 <i>AMBER DISPLAY 160X80 0355DP RYL</i>
	13		<b>17000271</b>	BLACK DISPLAY SEAL RYL <i>BLACK DISPLAY SEAL RYL</i>
	14	 ПІД ЗАМОВЛЕННЯ	<b>421946000581</b>	14P.FLAT CABLE CPU-PWR V2 RYL <i>14P.FLAT CABLE CPU-PWR V2 RYL</i>
	15	 ПІД ЗАМОВЛЕННЯ	<b>11027086</b>	PWR BOARD RYL/RYOLO 120V <i>PWR BOARD RYL/RYOLO 120V</i>
	15		<b>11030311</b>	PWR BOARD RYOLO 230V <i>PWR BOARD RYOLO 230V</i>
	15	 ПІД ЗАМОВЛЕННЯ	<b>421941302411</b>	PWR BOARD RYOLO 120V <i>PWR BOARD RYOLO 120V</i>
	16		<b>11028842</b>	BLACK PWR BOARD SUPPORT RYL UL <i>BLACK PWR BOARD SUPPORT RYL UL</i>
	16	 ПІД ЗАМОВЛЕННЯ	<b>17000275</b>	BLACK PWR BOARD SUPPORT RYL <i>BLACK PWR BOARD SUPPORT RYL</i>
	17	 ПІД ЗАМОВЛЕННЯ	<b>11028843</b>	POWER BOARD PROTECTION RYL UL <i>POWER BOARD PROTECTION RYL UL</i>
	17	 ПІД ЗАМОВЛЕННЯ	<b>17001152</b>	POWER BOARD PROTECTION RYL <i>POWER BOARD PROTECTION RYL</i>
	18	 ПІД ЗАМОВЛЕННЯ	<b>421941277592</b>	BLK CPU BOARD SUPPORT V2 RYL <i>BLK CPU BOARD SUPPORT V2 RYL</i>

## Model Machine

MACSAE156

AULIKA FOCUS (10004472 )



19

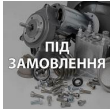

17000430

TRANSP.RIGHT TOUCH PANEL RYL  
*TRANSP.RIGHT TOUCH PANEL RYL*



20



12000450

SCREW TCBR TORX 10 3,5X12 PLAST.ZN-N  
*SCREW TCBR TORX 10 3,5X12 PLAST.ZN-N*



21



17000277

BLACK CPU-PWR BOARDS COVER RYL  
*BLACK CPU-PWR BOARDS COVER RYL*

# Model Machine

MACSAE156

AULIKA FOCUS (10004472 )

MACSAE156.T.0004

TAVOLA NR. 4 - ARTICOLO AULIKA FOCUS ( 10004472 )

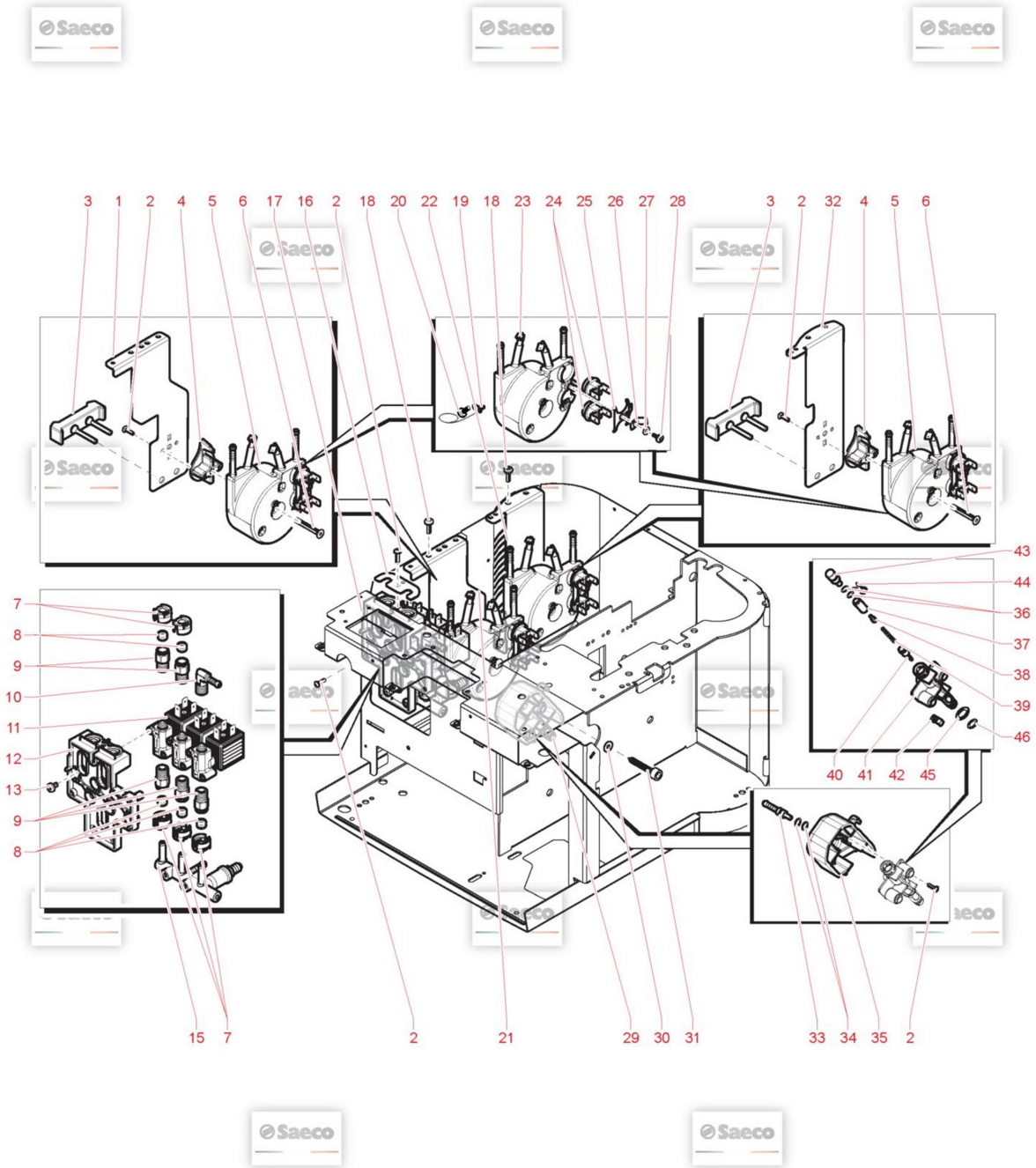



## Model Machine

MACSAE156

AULIKA FOCUS (10004472 )

Web Pos. Foto Item - Replace by Description



Press - CTRL + CLICK go to item in a new window

Натисніть - Ctrl + права кнопка миші щоб відкрити запчастину в новому вікні



1

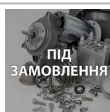

421941276892

STEEL STEAM TUBOL.BOILER SUPPORT V2 RYL  
STEEL STEAM TUBOL.BOILER SUPPORT V2 RYL



2



12000450

SCREW TCBR TORX 10 3,5X12 PLAST.ZN-N  
SCREW TCBR TORX 10 3,5X12 PLAST.ZN-N



3

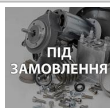

17000471

BLACK BOILER ANTIVIBRATION RYL  
BLACK BOILER ANTIVIBRATION RYL



4

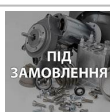

421944057621

NEU SLIM TUB.BOILERS SUPPORT V2 MYB9  
NEU SLIM TUB.BOILERS SUPPORT V2 MYB9



5

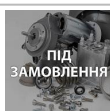

11026313

SLIM TUB.BOIL.C2 T190°-190°1300W 230V AS  
AS.CALD.TUB.SLIM C2 T190°-190°1300W 230V



5

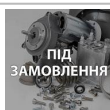

11026314

SLIM TUB.BOIL.C2 T190°-190°1300W 120V AS  
AS.CALD.TUB.SLIM C2 T190°-190°1300W 120V



5

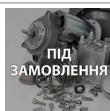

11026315

SLIM TUB.BOIL.C2 T190°-190°1100W 100V AS  
SLIM TUB.BOIL.C2 T190°-190°1100W 100V AS



6

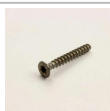

12001369

SCREW TSP TORX 10 5X35 PLAST.SS  
SCREW TSP TORX 10 5X35 PLAST.SS



7



17001178

BLK EV 1/8"GAS.CONNECTOR V2 INSERT RYL  
BLK EV 1/8 GAS.CONNECTOR V2 INSERT RYL



8



17001909

RED EV CONNECTOR 1/8"GAS SEALV2 RYL  
RED EV CONNECTOR 1/8 GAS SEAL V2 RYL



9



11027334

З'ЄДНАННЯ 1/8"GAS V2 RYL  
TEA/BRASS ELECTROV.CONNECT1/8"GAS V2 RYL



10



11024469

L-F/BRASS CONNECTOR FOR BOILER AURA  
L-F/BRASS CONNECTOR FOR BOILER AURA



11













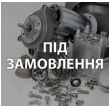

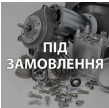













17001262

LFBRASS 2W.EV 21JN1R4V20-X031  
LFBRASS 2W.EV 21JN1RRV20-X005+LBV05024CU

## Model Machine

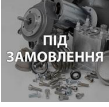
MACSAE156



























AULIKA FOCUS (10004472 )

	12		<b>17000168</b>	BLACK ELECTROV/CONNECTOR SUPP.RYL <i>BLACK ELECTROV/CONNECTOR SUPP.RYL</i>
	13		<b>U043.012</b>	SCREW TCB TORX 20 M4X6 ZN-B <i>VITE TCBC M4,0X6 UNI 7687 Z</i>
	14		<b>NM01.057</b>	OR ORM 0050-20 IN SILICONE <i>OR ORM 0050-20 IN SILICONE</i>
	15		<b>17001908</b>	BRASS 4WAYS CONNECT+SAFETY VALVE V3 RYL <i>BRASS 4WAYS CONNECT+SAFETY VALVE V3 RYL</i>
	16		<b>17000428</b>	STEEL CONNECTORS FIXING PLATERYL <i>STEEL CONNECTORS FIXING PLATE RYL</i>
	17		<b>11031414</b>	TEA/BRASS ELECTROV.V3 24V RYL/T ASSY. PHILIPS SAECO 996530073228 <i>TEA/BRASS ELECTROV.V3 24V RYL/T ASSY.</i>
	18		<b>12001622</b>	SCREW TCB TORX B 3,5X9,5 SCHEET NIK <i>SCREW TCB TORX B 3,5X9,5 SCHEET NIK</i>
	19		<b>190800100</b>	ТЕМПЕРАТУРНИЙ СЕНСОП NTC UL L=280MM <i>TEMPERATURE SENSOR NTC UL L=280MM</i>
	20		<b>129573402</b>	SCREW TAPT M4X10 DIN 7985 GALV <i>SCREW TAPT M4X10 DIN 7985 GALV</i>
	21		<b>11025706</b>	STEAM TUB.BOILER 230V RYL ASSY. <i>STEAM TUB.BOILER 230V RYL ASSY.</i>
	21		<b>11028183</b>	STEAM TUB.BOILER 120V RYL ASSY. <i>STEAM TUB.BOILER 120V RYL ASSY.</i>
	22		<b>11025705</b>	COFFEE TUB.BOILER 230V RYL/T ASSY. <i>COFFEE TUB.BOILER 230V RYL/T ASSY.</i>
	22		<b>11028182</b>	COFFEE TUB.BOILER 120V RYL/T ASSY. <i>COFFEE TUB.BOILER 120V RYL/T ASSY.</i>
	22		<b>421946018111</b>	COFFEE TUB.BOILER 100V RYL/T ASSY. <i>COFFEE TUB.BOILER 100V RYL/T ASSY.</i>

## Model Machine

MACSAE156











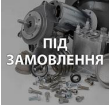











AULIKA FOCUS (10004472 )

	23		<b>11013735</b>	SLIM TUB.BOILER 1300W 230V ASSY. <i>SLIM TUB.BOILER 1300W 230V ASSY. NUOVO PREZZO 13,3</i>
	23		<b>11023153</b>	SLIM TUB.BOILER 1300W 120V ASSY. <i>SLIM TUB.BOILER 1300W 120V ASSY.</i>
	23	 ПІД ЗАМОВЛЕННЯ	<b>11024193</b>	SLIM TUB.BOILER 1100W 100V ASSY. <i>SLIM TUB.BOILER 1100W 100V ASSY.</i>
	24		<b>12001033</b>	ТЕРМОСТАТ 190°С БОЙЛЕРА ДЛЯ КОФЕВАРОК PHILIPS SAECO 12001033 <i>THERMOSTAT ONE SHOT 190°</i>
	25	 ПІД ЗАМОВЛЕННЯ	<b>11001751</b>	TUB.BOILER V3 UPPER THERM.FIXING SPRING <i>TUB.BOILER V3 UPPER THERM.FIXING SPRING</i>
	26		<b>124390520</b>	BRASS BENT FASTON 45° 6,3X0,8 <i>BRASS BENT FASTON 45° 6,3X0,8</i>
	27		<b>128310402</b>	GALV.WASHER UNI 8842 A4 <i>GALV.WASHER UNI 8842 A4</i>
	28	 ПІД ЗАМОВЛЕННЯ	<b>12001715</b>	SCREW TCB TORX 20 M4X8 AUTOFORMING ZN-B <i>SCREW TCB TORX 20 M4X8 AUTOFORMING ZN-B</i>
	29		<b>11025744</b>	TEA/BRASS HOT WATER PIN RYL ASSY. <i>TEA/BRASS HOT WATER PIN RYL ASSY.</i>
	30	 ПІД ЗАМОВЛЕННЯ	<b>128310521</b>	WASHER UNI 8842 A5 SS <i>WASHER UNI 8842 A5 SS</i>
	31	 ПІД ЗАМОВЛЕННЯ	<b>11003555</b>	GALVANIZED SELF-TAPPING SCREW 4,8X32 <i>GALVANIZED SELF-TAPPING SCREW 4,8X32</i>
	32	 ПІД ЗАМОВЛЕННЯ	<b>17000163</b>	STEEL COFFEE TUBOL.BOILER SUPPORT RYL/T <i>STEEL COFFEE TUBOL.BOILER SUPPORT RYL</i>
	33		<b>11000750</b>	TEA/BRASS CONNECTOR FOR SILICONE TUBE <i>TEA/BRASS CONNECTOR FOR SILICONE TUBE</i>

## Model Machine

MACSAE156

AULIKA FOCUS (10004472 )

	34		140328059	OR 2015 SILICONE PTFE/FDA <i>OR 2015 SILICONE PTFE/FDA</i>
	35		17000156	BLACK HOT WATER PIN SUPPORT RYL <i>BLACK HOT WATER PIN SUPPORT RYL</i>
	36		140326662	OR ORM 0040-20 SILICONE <i>OR METRIC 0040-20 IN SILICONE</i>
	37		11009012	TEA/BRASS BOILER PIN BUSH <i>TEA/BRASS BOILER PIN BUSH</i>
	38		11009013	TEA/BRASS PIN FOR PISTON L=10 <i>TEA/BRASS PIN FOR PISTON L=10</i>
	39		9011.132	SS SPRING FOR PIN <i>MOLLA X SPILLO</i>
	40		11009019	TEA/BRASS PISTON L=20,9 ASSY. <i>TEA/BRASS PISTON L=20,9 ASSY.</i>
	41		9161.434	HOT WATER PIN <i>PERNO CALDAIA MAGIC,ROYAL SAECO</i>
	42		11005099	NATURAL CURSOR V2 FOR BOILER P119 <i>NATURAL CURSOR V2 FOR BOILER P119</i>
	43		11026413	TEA/BRASS HOT WATER PIN PLUG RYL <i>TEA/BRASS HOT WATER PIN PLUG RYL</i>
	44		9011.144	SS FORK FOR TUBE D=4 <i>FORCELLA X TUBO D.4</i>
	45		NM01.035	OR ORM 0090-20 SILICONE <i>OR ORM 0090-20 SILICONE</i>

# Model Machine

MACSAE156

AULIKA FOCUS (10004472 )

MACSAE156.T.0005

TAVOLA NR. 5 - ARTICOLO AULIKA FOCUS ( 10004472 )

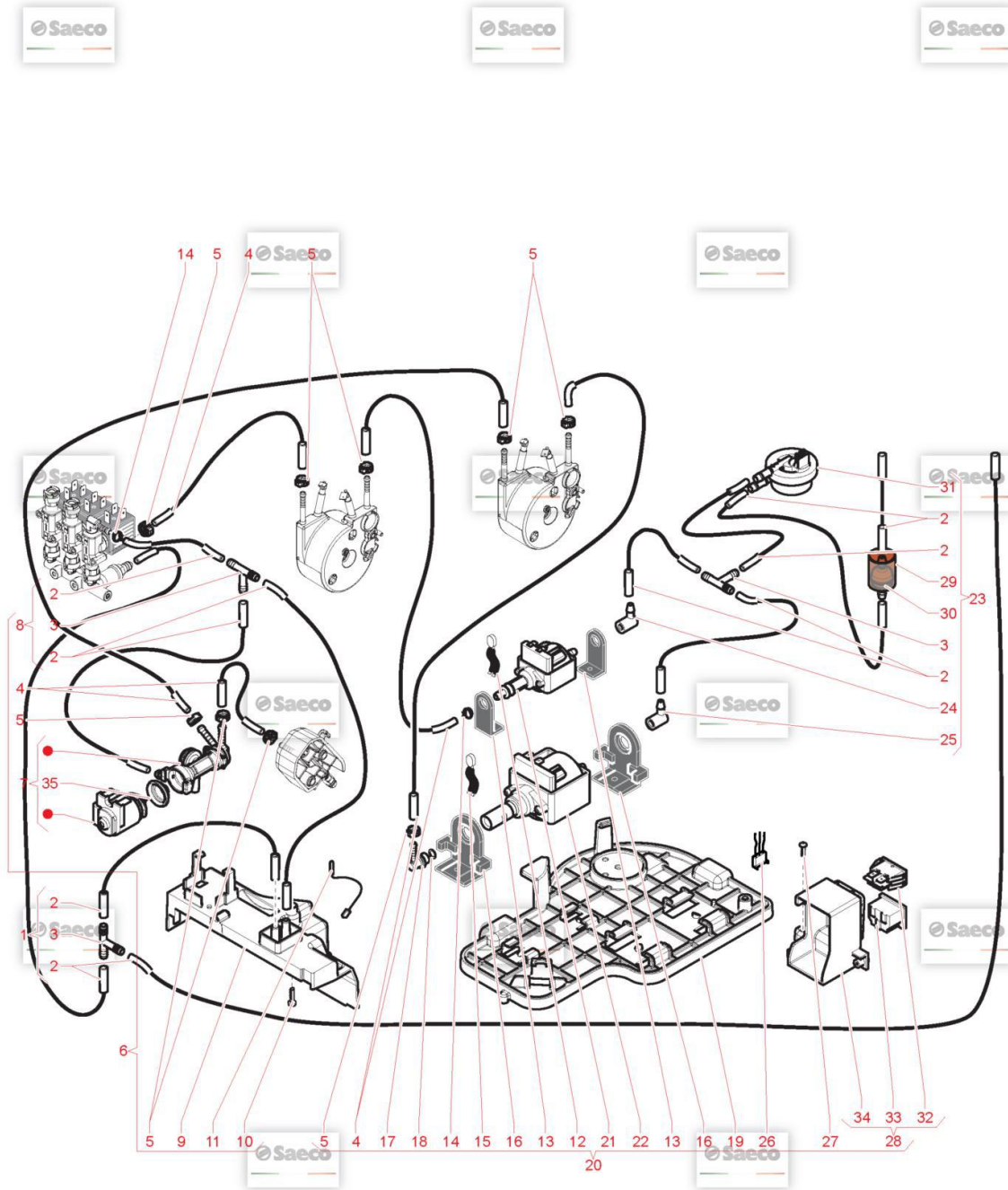

## Model Machine

MACSAE156

AULIKA FOCUS (10004472 )

Web Pos. Foto Item - Replace by Description



Press - CTRL + CLICK go to item in a new window

Натисніть - Ctrl + права кнопка миші щоб відкрити запчастину в новому вікні



1

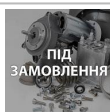

11027095

WATER CONTAINER/EV DRAIN TUBESRYL ASSY.  
WATER CONTAINER/EV DRAIN TUBESRYL ASSY.



2



11035450

SILICONE TUBE 5X10 L.2000MM  
TUBO SILICONE 5X10 TRASP. L.2000MM



3



147920300

TRANS.CONNECTOR D=8 ART.80.26.047 KA.461  
RACCORDO T D=8 ART.80.26.047 KA.461



4

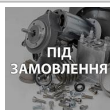

11027788

PINK 5X8,9 SILICONE TUBE L=2000MM  
TUBO SIL.RETIN.5X8.9 L=2000MM ROSA



5



12000892

ЗАЖИМ D.9,5 16700004  
OETIKER CLAMP D=9,5 16700004 ( L250 )



6

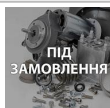

11025743

230V/BLK PROT+BLOWDOWN VALVE RYL/T ASSY.  
230V/BLK PROT+BLOWDOWN VALVE RYL/T ASSY.



6

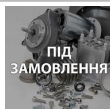

11028149

220-60HZ/BLK PROT+BLOWD.VALVERYL/T ASSY  
220-60HZ/BLK PROT+BLOWD.VALVERYL/T ASSY



6

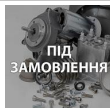

11028186

120V/BLK PROT+BLOWDOWN VALVE RYL/T ASSY.  
120V/BLK PROT+BLOWDOWN VALVE RYL/T ASSY.



6



421946018131

100V/BLK PROT+BLOWDOWN VALVE RYL/T ASSY.  
100V/BLK PROT+BLOWDOWN VALVE RYL/T ASSY.



7



11025742

BLOWDOWN VALVE V3 RYL 230V ASSY.  
BLOWDOWN VALVE V3 RYL 230V ASSY.



7

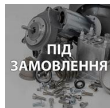

11028161

BLOWDOWN VALVE V3 RYL 220V-60HZ ASSY.  
BLOWDOWN VALVE V3 RYL 220V-60HZ ASSY.



7

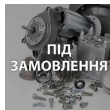

11028187

BLOWDOWN VALVE V3 RYL 120V ASSY.  
BLOWDOWN VALVE V3 RYL 120V ASSY.



7































421946018141

BLOWDOWN VALVE RYL 100V ASSY.  
BLOWDOWN VALVE RYL 100V ASSY.

## Model Machine

MACSAE156

















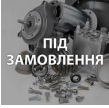





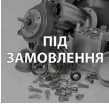

AULIKA FOCUS (10004472 )

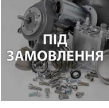
	8		<b>11025741</b>	VALVE/EV DRAIN TUBES RYL ASSY. VALVE/EV DRAIN TUBES RYL ASSY.
	9		<b>17000165</b>	BLACK DRIP TRAY PROTECTION RYL BLACK DRIP TRAY PROTECTION RYL
	10		<b>129913902</b>	SCREW TCB TORX 10 3X12 PLAST.ZN-B SCREW TCB TORX 10 3X12 PLAST.ZN-B
	11		<b>17800442</b>	2POLES CONNECT.SENSOR REED DUMP BOX CST 2POLES CONNECT.SENSOR REED DUMP BOX CST
	12		<b>17800203</b>	ДВОПОЛЮСОВИЙ ДАТЧИК ПЕРЕГРІВУ ПОМПИ ВЗБОРІ PHILIPS SAECO ... 2POLES CONNECTOR STEAM PUMP RYL UL
	13		<b>11029554</b>	BLACK/SBD ULKA MF PUMP SUPPORT BLACK/SBD ULKA MF PUMP SUPPORT
	14		<b>184320200</b>	SPRING HOSE CLAMP D=9,5MM MOLLA STRINGITUBO D=9,5MM
	15		<b>17800202</b>	2POLES CONNECTOR COFFEE PUMP RYL UL 2POLES CONNECTOR COFFEE PUMP RYL UL
	16		<b>11022857</b>	BLACK PUMP SUPPORT GMYB BLACK PUMP SUPPORT GMYB
	17		<b>11001054</b>	СОЕДИНИТЕЛЬНЫЙ УГОЛОК 90° К НАСОСУ P0049/B PHILIPS SAECO 996... BLK PUMP OUTLET 90° CONNECTOR P0049/B
	18		<b>140321961</b>	ПРОКЛАДКА O-RING ДЛЯ КАВОМАШИНИ SAECO 2031 TERMOIL OR 2031 IN TERMOIL
	19		<b>17000973</b>	BLACK COMPONENTS SUPPORT RYLO BLACK COMPONENTS SUPPORT RYLO
	20		<b>11034678</b>	COMPONENTS SUPP.V3 230V RYLO ASSY. AS.SUPP.COMPONENTI V3 RYLO 230V
	20		<b>11034705</b>	COMPONENTS SUPP.220V-60HZ V2 RYL ASSY. COMPONENTS SUPP.220V-60HZ V2 RYL ASSY.

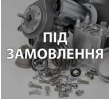
## Model Machine

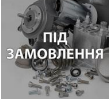
MACSAE156

AULIKA FOCUS (10004472 )











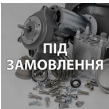



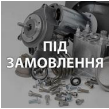

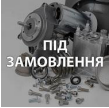





	20		<b>11034706</b>	COMPONENTS SUPP. V2 120V RYL ASSY. <i>COMPONENTS SUPP. V2 120V RYL ASSY.</i>
	20		<b>11034709</b>	COMPONENTS SUPP. V2 100V RYL ASSY. <i>COMPONENTS SUPP. V2 100V RYL ASSY.</i>
	21		<b>12001212</b>	ULKA PUMP MF 230V-50HZ <i>ULKA PUMP MF 230V-50HZ</i>
	21		<b>12001346</b>	ULKA PUMP MF 120V-60HZ <i>POMPA ULKA MF 120V-60HZ</i>
	21		<b>12001347</b>	ULKA PUMP MF 100V-50/60HZ <i>POMPA ULKA MF 100V-50/60HZ</i>
	21		<b>12001348</b>	ULKA PUMP MF 220V-50/60HZ <i>ULKA PUMP MF 220V-50/60HZ</i>
	22		<b>12000130</b>	ULKA PUMP EP5/S GW 100V-50/60HZ <i>ULKA PUMP EP5/S GW 100V-50/60HZ</i>
	22		<b>12000131</b>	ULKA PUMP EP5/S 120V-60HZ <i>ULKA PUMP EP5/S 120V-60HZ</i>
	22		<b>12000182</b>	ULKA PUMP EP5/S GW 220V-60HZ <i>ULKA PUMP EP5/S GW 220V-60HZ</i>
	22		<b>421941305991</b>	ULKA PUMP EP5FMGW 230V-50HZ <i>ULKA PUMP EP5FMGW 230V-50HZ</i>
	23		<b>11025709</b>	GEN.TURBINE RYL/T ASSY. <i>AS.GEN.TURBINA RYL/T</i>
	24		<b>11012193</b>	90° INLET CONNECTOR FOR PUMP ULKA MF <i>90° INLET CONNECTOR FOR PUMP ULKA MF</i>
	25		<b>147920150</b>	90° INLET PUMP CONNECTOR <i>RACCORDO A 90° IN SANTOPRENE</i>

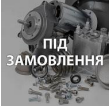

## Model Machine

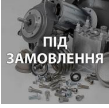
MACSAE156

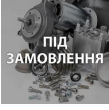
AULIKA FOCUS (10004472 )

	26		<b>421946001551</b>	6P.CONN.FLOWMETER V3 RYL UL ASSY. <i>6P.CONN.FLOWMETER V3 RYL UL ASSY.</i>
	27		<b>12000450</b>	SCREW TCBR TORX 10 3,5X12 PLAST.ZN-N <i>SCREW TCBR TORX 10 3,5X12 PLAST.ZN-N</i>
	28		<b>17800455</b>	IEC CONNECTOR RYL UL ASSY. <i>IEC CONNECTOR RYL UL ASSY.</i>
	28		<b>421941294291</b>	IEC CONNECTOR V2 RYL ASSY. <i>IEC CONNECTOR V2 RYL ASSY.</i>
	29		<b>147756562</b>	BLK PROTECTION FOR FOLK SPRINGTUBE D=4 <i>BLK PROTECTION FOR FOLK SPRING TUBE D=4</i>
	30		<b>12001595</b>	TRANSP/WHITE ASPIRATION FILTERMDS <i>TRANSP/WHITE ASPIRATION FILTER MDS</i>
	31		<b>NV99.099</b>	TURBINE D=1,2 ASSY. <i>TURBINA DIGMESA FHKSC 1,2 ARNITE OC</i>
	32		<b>NE03.038</b>	BIPOLAR SWITCH FUSIT C1250AR <i>BIPOLAR SWITCH FUSIT C1250AR</i>
	33		<b>12001883</b>	CUP SOCKET V3 EN 60320 C 13 <i>CUP SOCKET V3 EN 60320 C 13</i>
	34		<b>11028204</b>	BLACK SOCKET-SWITCH SUPPORT RYL UL <i>BLACK SOCKET-SWITCH SUPPORT RYL UL</i>
	34		<b>17000162</b>	BLACK SOCKET-SWITCH SUPPORT RYL <i>BLACK SOCKET-SWITCH SUPPORT RYL</i>
	35		<b>11001513</b>	МЕМБРАНА КЛАПАНА AULIKA, ODEA SAECO <i>GUARNIZ. A MEMBRANA VALV. SCARICO</i>

# Model Machine

MACSAE156

AULIKA FOCUS (10004472 )

MACSAE156.T.0006

TAVOLA NR. 6 - ARTICOLO AULIKA FOCUS ( 10004472 )

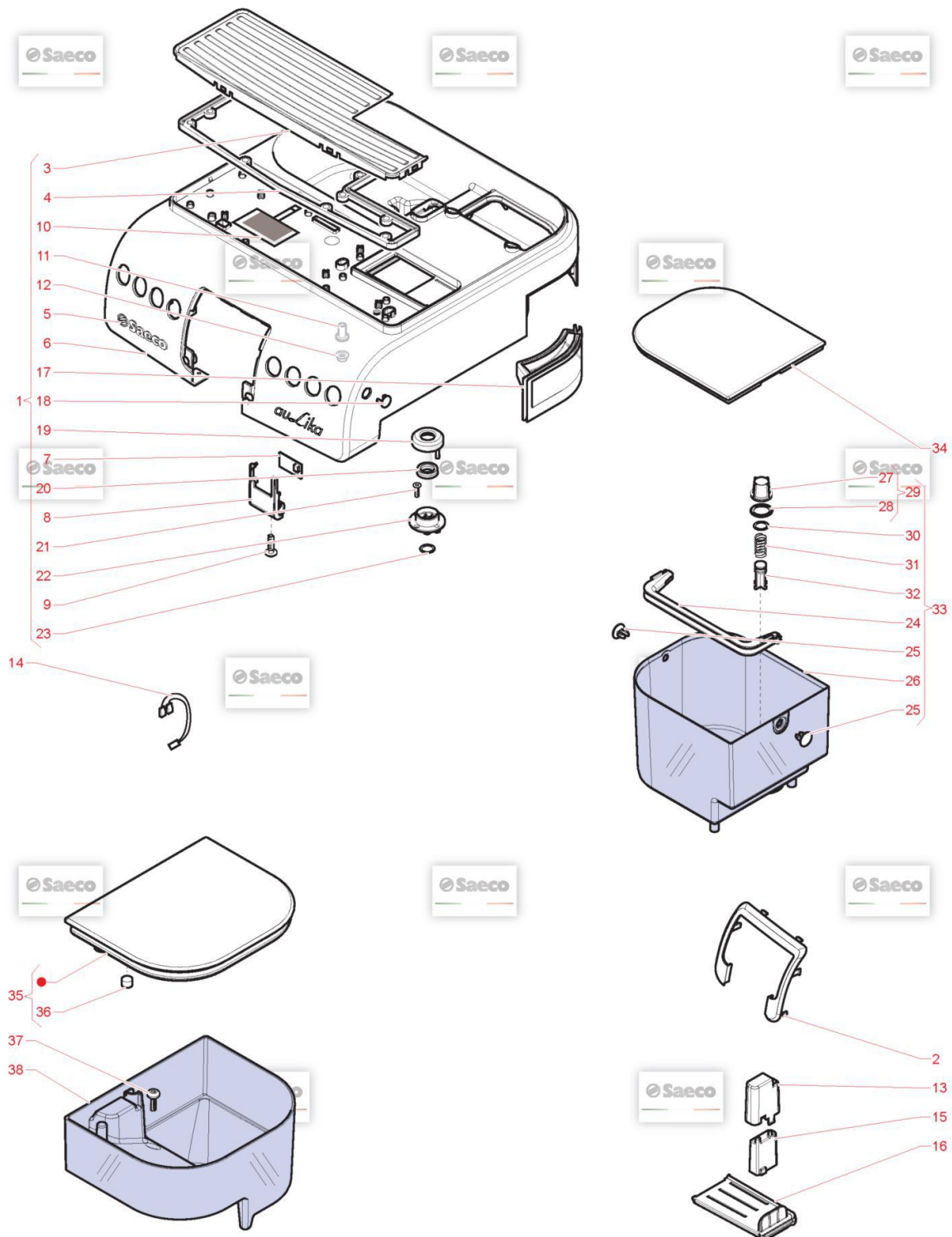

## Model Machine

MACSAE156

AULIKA FOCUS (10004472 )

Web Pos. Foto Item - Replace by Description



Press - CTRL + CLICK go to item in a new window

Натисніть - Ctrl + права кнопка миші щоб відкрити запчастину в новому вікні



1

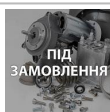

11029347

120V GL/SPEC.CASING COV.PSA RYL/T UL ASS  
120V GL/SPEC.CASING COV.PSA RYL/T UL ASS



1

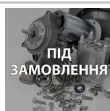

421941304751

230V GL/SPEC.CASING COVER RYLO/P ASSY.  
230V GL/SPEC.CASING COVER RYLO/P ASSY.



1

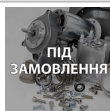

421946018081

120V GL/SPEC.CASING COVER RYLO/P ASSY.  
120V GL/SPEC.CASING COVER RYLO/P ASSY.



2

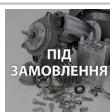

11025757

GLOSS/SPEC.FRONT PANEL RYL  
GLOSS/SPEC.FRONT PANEL RYL



3

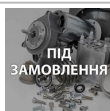

17000175

SB/SS CUPWARMING LID RYL  
SB/SS CUPWARMING LID RYL



4

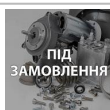

17000349

BLACK SEAL FOR CUPWARMING LIDRYL  
BLACK SEAL FOR CUPWARMING LID RYL



5

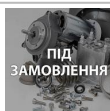

11030768

ADHES.SILVER PLATE LOGO SAECONPR  
ADHES.SILVER PLATE LOGO SAECO NPR



6

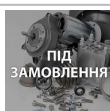

11029346

GL/SPEC.CASING COVER S/S.CAPPUC.RYL/T UL  
GL/SPEC.CASING COVER S/S.CAPPUC.RYL/T UL



6

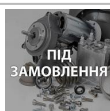

421944008921

GLO/SPEC.CASING COVER S/SCR.RYLO/P  
GLO/SPEC.CASING COVER S/SCR.RYLO/P



7

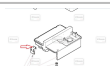

421941306721

ПЛАТА-СЕНСОР РІВНЯ ВОДИ V3 A  
CPU+SW WATER LEVEL SENSOR V3 ASSY.



8

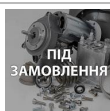

17000391

BLACK WATER LEVEL SENSOR SUPPORT RYL  
BLACK WATER LEVEL SENSOR SUPPORT RYL



9



12000450

SCREW TCBR TORX 10 3,5X12 PLAST.ZN-N  
SCREW TCBR TORX 10 3,5X12 PLAST.ZN-N



10

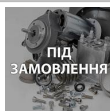

























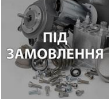

11000791

ADHESIVE HEATING-ELEMENT 120V  
ADHESIVE HEATING-ELEMENT 120V

## Model Machine

MACSAE156

















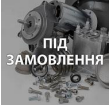







AULIKA FOCUS (10004472 )

	10		<b>WGA4316031000</b>	ADHESIVE HEATING-ELEMENT 230V <i>ADHESIVE HEATING-ELEMENT 230V</i>
	11		<b>17000826</b>	BRASS CUPWARMING LID BUSH RYL <i>BRASS CUPWARMING LID BUSH RYL</i>
	12		<b>U324.005</b>	NUT M3 FLANGED INDENTED BASE <i>DADO M3 FLANGIATO BASE DENTELLATA</i>
	13		<b>17000239</b>	GREY BEAN CONTAINER SENSOR SUPPORT RYL <i>GREY BEAN CONTAINER SENSOR SUPPORT RYL</i>
	14		<b>421946000521</b>	2P.CONN.SUPPLY CUPWARMER V2 RYL UL ASSY. <i>2P.CONN.SUPPLY CUPWARMER V2 RYL UL ASSY.</i>
	15		<b>17001480</b>	BLK BEAN CONTAIN.SENSOR SUPP.INSERT RYL <i>BLK BEAN CONTAIN.SENSOR SUPP.INSERT RYL</i>
	16		<b>11025739</b>	SB/SS GROUND CONT.DOOR COVER S/S.RYL ASS <i>AS.COP.SPORT.CONT.CAF.MAC.RYL IN/SB SER.</i>
	17		<b>11025771</b>	GLOSS/SPEC.COVER CASING INSERTS/SCR.RYL <i>GLOSS/SPEC.COVER CASING INSERT S/SCR.RYL</i>
	18		<b>17000422</b>	TRANSP.INFRAREDS PLATE RYL <i>TRANSP.INFRAREDS PLATE RYL</i>
	19		<b>0701.031.150</b>	GREY WATER VALVE GACO DIM 14 SEAL COVER <i>SEAL COVER GREY</i>
	20		<b>145842900</b>	NBR WATER CONT.VALVE GACO DIM14 SEAL <i>NBR WATER CONT.VALVE GACO DIM14 SEAL</i>
	21		<b>12000895</b>	SCREW TSP TORX 10 3X10 PLAST.SS <i>SCREW TSP TORX 10 3X10 PLAST.SS</i>
	22		<b>0701.014.150</b>	GREY WATER VALVE GACO DIM 14 SEAL CONT. <i>GREY WATER VALVE GACO DIM 14 SEAL CONT.</i>
	23		<b>140320461</b>	OR ORM 0080-20 TERMOIL <i>OR ORM 0080-20 IN TERMOIL</i>

## Model Machine

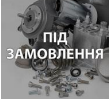
MACSAE156

AULIKA FOCUS (10004472 )

	24		17000174	BLACK WATER CONTAINER HANDLE RYL <i>BLACK WATER CONTAINER HANDLE RYL</i>
	25		17001255	ЗАТИЧКА 1 ШТ <i>BLACK PLUG FOR WATER CONTAIN.HANDLE RYL</i>
	26		11027676	NAT/GREY WATER CONTAINER S/SCR.RYL <i>NAT/GREY WATER CONTAINER S/SCR.RYL</i>
	27		144650800	WHITE WATER CONTAINER EXT.FILTER <i>WHITE WATER CONTAINER EXT.FILTER</i>
	28		140328461	ПРОКЛАДКА O-RING 0190-10 ДЛЯ КОФЕМАШИНЫ PHILIPS SAECO 99653... <i>OR METRICO 0190-10 IN EPDM NUOVO PREZZO 0,13</i>
	29		224640200	БІЛИЙ ПЛАСТИКОВИЙ ФІЛЬТР У КОНТЕЙНЕР ВОДИ SAECO 996530029115 <i>EXTERNAL FILTER FOR WATER CONTAINER ASSY</i>
	30		140324362	OR ORM 0060-30 SILICONE <i>OR METRIC 0060-30 IN SILICONE</i>
	31		126764718	SS WATER CONTAINER VALVE SPRING <i>SS WATER CONTAINER VALVE SPRING</i>
	32		147660562	GREY PISTON FOR WATER CONTAINER VALVE <i>GREY PISTON FOR WATER CONTAINER VALVE</i>
	33		11025725	NAT/GREY WATER CONTAINER S/SCR.RYL ASSY. <i>AS.CONT.ACQ.RYL GRI/NAT.SER.</i>
	34		11027653	GLOSS/SPEC.WATER CONTAINER LIDRYL <i>GLOSS/SPEC.WATER CONTAINER LID RYL</i>
	35		11027679	GLOSS/SPE.BEAN COF.CONT.LID RYL ASSY. <i>GLOSS/SPE.BEAN COF.CONT.LID RYL ASSY.</i>
	36		11004160	D=6 H=4 MAGNET P0049 <i>D=6 H=4 MAGNET P0049</i>

## Model Machine

MACSAE156

AULIKA FOCUS (10004472 )



37

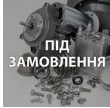

12001431

SCREW TCB TORX 10 3X12 PLAST.SS

SCREW TCB TORX 10 3X12 PLAST.SS



38



17000188

NAT/GREY BEAN CONTAINER RYL

NAT/GREY BEAN CONTAINER RYL

# Model Machine

MACSAE156

AULIKA FOCUS (10004472 )

MACSAE156.T.0007



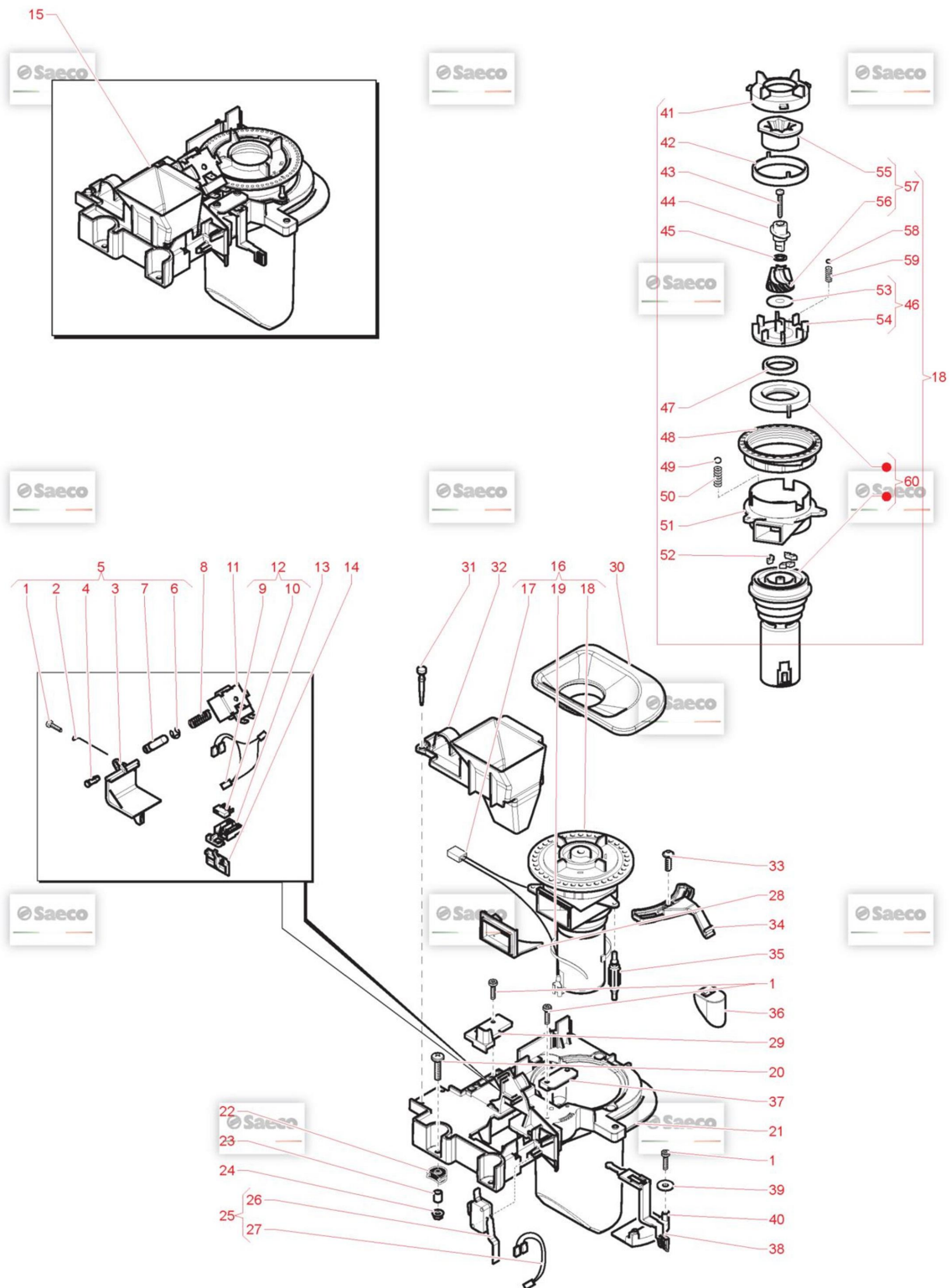























TAVOLA NR. 7 - ARTICOLO AULIKA FOCUS ( 10004472 )



## Model Machine

MACSAE156

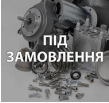
AULIKA FOCUS (10004472 )













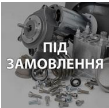













Web	Pos.	Foto	Item - Replace by	Description
				<i>Press - CTRL + CLICK go to item in a new window Натисніть - Ctrl + права кнопка миші щоб відкрити запчастину в новому вікні</i>
	1		129913902	SCREW TCB TORX 10 3X12 PLAST.ZN-B SCREW TCB TORX 10 3X12 PLAST.ZN-B
	2		9161.048	STEEL GROUND COF.DOSER SCRAPERROD ASTA RASATORE
	3		9161.074.150	GREY GROUND COFFE DOSER DOOR SPORTELLO DOSATORE GRIGIO
	4		9161.076.150	GREY GROUND COF.DOSER DOOR PIN PERNO SPORTELLO DOSATORE GRIGIO
	5	 ПІД ЗАМОВЛЕННЯ	9140.017	GREY GROUND COF.DOSER DOOR ASSY. DOSER DOOR ASSEMBL.GREY
	6		U701.003	SNAP RING 7 UNI 7434 ANELLO ELASTICO 7 UNI 7434
	7		9161.041	STEEL GROUND COF.DOSER ELECTROMAGN.CORE NUCLEO ELETTRROMAGNETE DOSATORE
	8		126764818	ПРУЖИНА ЕЛЕКТРОМАГНІТНОГО ДОЗАТОРА ЗЕРНА MAGIC SAECO 916... SPRING ELECTROM.BEAN DOSER MAGIC
	9	 ПІД ЗАМОВЛЕННЯ	421946000541	4P.CONN.COIL+DOSER MICRO V2 RYL UL ASSY. 4P.CONN.COIL+DOSER MICRO V2 RYL UL ASSY.
	10		NE05.017	MICROSWITCH MICROSWITCH NE05.017
	11		11025734	DOSER COIL FOR SUPERAUTOM.24VDC ASSY. DOSER COIL FOR SUPERAUTOM.24V DC ASSY.
	12	 ПІД ЗАМОВЛЕННЯ	421946000921	COIL WIRING+DOSER MICRO V2 RYLUL ASSY. COIL WIRING+DOSER MICRO V2 RYLUL ASSY.
	13		9161.072.150	GREY MICRO SUPP.CURSOR GROUND COF.DOSER MICRO SUPPORT CURSOR GREY

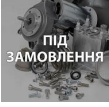

## Model Machine

MACSAE156



























AULIKA FOCUS (10004472 )

	14		<b>9161.073.150</b>	GREY GROUND COF.DOSE CONTROL COMPENSATOR <i>DOSE CONTROL COMPENSATOR GREY</i>
	15	 ПІД ЗАМОВЛЕННЯ	<b>11025732</b>	PLATE COFFEE GRINDER GEN.RYL 230V ASSY. <i>PLATE COFFEE GRINDER GEN.RYL 230V ASSY.</i>
	15	 ПІД ЗАМОВЛЕННЯ	<b>11028180</b>	PLATE COFFEE GRINDER GEN.RYL 120V ASSY. <i>PLATE COFFEE GRINDER GEN.RYL 120V ASSY.</i>
	15	 ПІД ЗАМОВЛЕННЯ	<b>421946018101</b>	PLATE COFFEE GRINDER GEN.RYL 100V ASSY. <i>PLATE COFFEE GRINDER GEN.RYL 100V ASSY.</i>
	16	 ПІД ЗАМОВЛЕННЯ	<b>11027917</b>	COFFEE GRINDER STD CALIBRATED230V ASSY. <i>AS.MACINACAFFE STD TARATO 230V</i>
	16	 ПІД ЗАМОВЛЕННЯ	<b>11028181</b>	COFFEE GRINDER STD CALIBRATED120V ASSY. <i>AS.MACINACAFFE STD TARATO 120V</i>
	16	 ПІД ЗАМОВЛЕННЯ	<b>421946018171</b>	COFFEE GRINDER STD CALIBRATED100V ASSY. <i>COFFEE GRINDER STD CALIBRATED100V ASSY.</i>
	17	 ПІД ЗАМОВЛЕННЯ	<b>421946000531</b>	2P.CONN.GRINDER MOTOR V2 RYL UL ASSY. <i>2P.CONN.GRINDER MOTOR V2 RYL UL ASSY.</i>
	18		<b>9140.036.00A</b>	КАВОМОЛКА В ЗБОРІ 230V PHILIPS SAECO 996530065687 <i>COFFEE GRINDER STD 230V ASSY.</i>
	18	 ПІД ЗАМОВЛЕННЯ	<b>9140.036.00F</b>	ASS.MOTOR STD 120V <i>ASS.MOTOR STD 120V</i>
	18	 ПІД ЗАМОВЛЕННЯ	<b>9140.036.00R</b>	ASS.MOTOR STD 100V 50/60HZ <i>ASS.MOTOR STD 100V 50/60HZ</i>
	19	 ПІД ЗАМОВЛЕННЯ	<b>144320200</b>	SELF LOCK STRIP W=2.6 L=200 <i>SELF LOCK STRIP W=2.6 L=200</i>
	20		<b>U043.004</b>	ZN-B TCB TORX 20 M4X16 ZN-B <i>VITE TCBC M4,0X16 UNI 7687 ZNP</i>
	21		<b>9161.365.150</b>	GREY PLATE COFFEEGRINDER MAGIC/ROYAL <i>PIASTRA X MACINACAFFE' GRIGIO/7016</i>

## Model Machine

MACSAE156















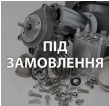











AULIKA FOCUS (10004472 )

	22		9991.005	RUBBER FOR COFFEE GRINDER <i>GOMMINO X MACINA CAFFE</i>
	23		9141.003	SPACER FOR RUBBER <i>SPACER FOR RUBBER</i>
	24		U324.006	ШАЙБА M4 <i>NUT M4 FLANGED INDENTED BASE</i>
	25		421946000911	MICROSWITCH DOOR V2 RYL UL ASSY. <i>AS.MICRO SPORT.V2 RYL UL</i>
	26		12001605	МІКРИК <i>MICROSWITCH</i>
	27		421946000501	2P.CONN.DOOR MICRO V2 RYL UL ASSY. <i>2P.CONN.DOOR MICRO V2 RYL UL ASSY.</i>
	28		1505.014	COFFEEGRINDER SEAL <i>GUARNIZIONE DOSATORE</i>
	29		17001155	GREY COVER FOR DOSER HOLE RYL <i>GREY COVER FOR DOSER HOLE RYL</i>
	30		17000238	COFFEE GRINDER SOUNDPROOFING COVER RYL <i>COFFEE GRINDER SOUNDPROOFING COVER RYL</i>
	31		9161.082	RUBBER COUPLER <i>AGGANCIO IN GOMMA</i>
	32		17000176	BLACK HOPPER FOR POWDER COFFEERYL <i>BLACK HOPPER FOR POWDER COFFEE RYL</i>
	33		12000450	SCREW TCBR TORX 10 3,5X12 PLAST.ZN-N <i>SCREW TCBR TORX 10 3,5X12 PLAST.ZN-N</i>
	34		17000198	BLACK GRINDING ADJUSTM.LEVER RYL <i>BLACK GRINDING ADJUSTM.LEVER RYL</i>

## Model Machine

MACSAE156



























AULIKA FOCUS (10004472 )

	35		9991.103	АМОТИЗАТОР ДЛЯ КОФЕМОЛКИ КОФЕМАШИН PHILIPS SAECO 996530... <i>AMMORTIZZATORE PER MACINACAFE</i>
	36		421941300291	BLK/SIL.GRIND.ADJUS.LEVER HANDGRIP RYL <i>BLK/SIL.GRIND.ADJUS.LEVER HANDGRIP RYL</i>
	37	 ПІД ЗАМОВЛЕННЯ	9161.097.150	GREY GROUND COF.DOSER LEVER FIXING PLATE <i>LEVER FIXING PLATE GREY</i>
	38		0313.003.150	7016/GREY GROUND COF.DOSER ADJUSTM.LEVER <i>LEVA DI REGOLAZIONE GRIGIO R</i>
	39		U201.001	PLAIN WASHER 3,2X9 DIN 7349 GALV. <i>PLAIN WASHER 3,2X9 DIN 7349 GALV.</i>
	40	 ПІД ЗАМОВЛЕННЯ	9161.403.150	GREY COFFEE DOSE ADJUSTMENT SCALE <i>GREY COFFEE DOSE ADJUSTMENT SCALE</i>
	41		149186150	BLACK UPPER GRINDER SUPPORT MAGIC <i>SUPPORT.NER.X MACINA SUPERIO</i>
	42		142844550	UPPER GRINDER COVER COFFEE GRIND. MAGIC <i>UPPER GRINDER COVER COFFEE GRIND. MAGIC</i>
	43	 ПІД ЗАМОВЛЕННЯ	129931002	TORX SCREW T10 TCB 3,5X40 SX ZNG <i>TORX SCREW T10 TCB 3,5X40 SX ZNG</i>
	44		147470763	BLK INCREASE SCREW PIN COF.GRINDER MAGIC <i>PERNO INCREM.A VITE X MACINA</i>
	45		U201.002	PLAIN WASHER 10X16X0,2DIN 988GAL <i>ROSETTA PIANA 10X16X0,2DIN</i>
	46	 ПІД ЗАМОВЛЕННЯ	149188750	CONICAL GRIND. SUPP. + RING MAGIC <i>CONICAL GRIND. SUPP. + RING MAGIC</i>
	47		140360200	FELT RING 40X34X5 <i>ANELLO IN FELTRO DE=40 DI=34</i>
	48		146570950	RING NUT FOR GRINDING ADJUSTMENT MAGIC <i>GHIERA NERA REGOLAZ.MACINATU</i>

## Model Machine

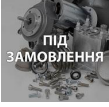
MACSAE156

AULIKA FOCUS (10004472 )

	49		128610421	STAIL.STELL AISI 304 SPHERE D=3,2MM <i>SFERA D=3,2MM ACCIAIO INOX A</i>
	50		126770117	NEW SPRING SPHERE D=3,2 MOTORMAGIG <i>MOLLA NEW X SFERA D=3,2 MOTORE MAGIC</i>
	51		9141.080	ТРИМАЧ ДВИГУНА КАВОМОЛКИ ДЛЯ КАВОВАРКИ SAECO 9141.080 <i>SUPPORTO MOTORE</i>
	52		140230400	SHOCK ABS .CONICAL GRINDER SUPP.MAGIC <i>AMMORTIZ.X SUPPOR.MACIN.CONI</i>
	53		9141.042	SAFETY RING <i>SAFETY RING</i>
	54		9141.028	BLACK LOWER GRINDER SUPPORT MAGIC <i>BLACK LOWER GRINDER SUPPORT MAGIC</i>
	55		9141.039	UPPER GRINDER <i>UPPER GRINDER</i>
	56		9141.040	CONICAL GRINDER <i>CONICAL GRINDER</i>
	57		226477700	KIT ITAL MILL GRINDERS <i>COPPIA DI MACINE SAECO CONICHE</i>
	58		128610521	STAIL.STEEL AISI 304 SPHERE D=5,5MM <i>SFERA D=5,5MM ACCIAIO INOX A</i>
	59		126765517	STEEL SPRING SPHERE D=5,5 MOTOR MAGIC <i>MOLLA ACC.X SFERA D=5,5 MOTO</i>
	60		0301.R10.00A	SPARE MOTOR UNIT MC 230V <i>GRUPPO RICAMBIO MOTORE MC 230 V</i>
	60		0301.R10.00F	SPARE MOTOR UNIT MC 120V <i>SPARE MOTOR UNIT MC 120V</i>
	60		0301.R10.00R	SPARE MOTOR UNIT MC 100V <i>SPARE MOTOR UNIT MC 100V</i>



# Model Machine

MACSAE156

AULIKA FOCUS (10004472 )

MACSAE156.T.0008

TAVOLA NR. 8 - ARTICOLO AULIKA FOCUS ( 10004472 )

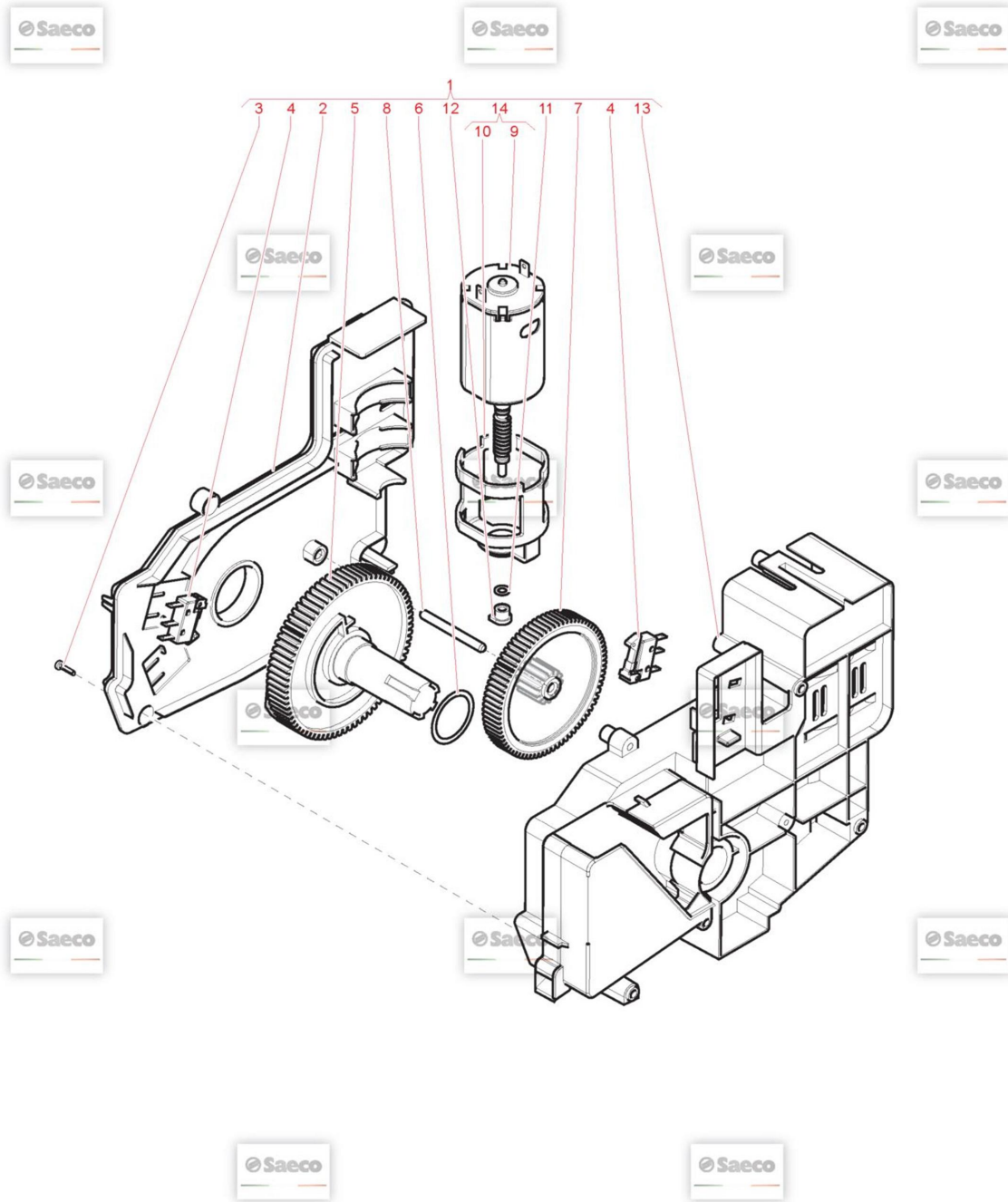

## Model Machine

MACSAE156

AULIKA FOCUS (10004472 )

Web Pos. Foto Item - Replace by Description



Press - CTRL + CLICK go to item in a new window  
Натисніть - Ctrl + права кнопка миші щоб відкрити запчастину в новому вікні



1



11025736

РЕДУКТОР ВЗБОРИ PHILIPS SAECO 996530068554  
RATIOMOTOR RYL ASSY.



2



17000719

GREY RATIOMOTOR LID RYL  
GREY RATIOMOTOR LID RYL



3



129670202

TCB PANELVIT SCREW 3,5X16 TESTA D=8 ZNP  
TCB PANELVIT SCREW 3,5X16 TESTA D=8 ZNP



4



NE05.038

MICROSWITCH 30V 0.3A  
MICROINTERRUTTORE



5

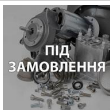

11007137

BLACK GEAR Z=77 V2 FOR RATIOMOTOR P124  
BLACK GEAR Z=77 V2 FOR RATIOMOTOR P124



6



9161.368

MYLAR WASHER FOR RATIOMOTOR  
RONDELLA MYLAR X MOTORIDUTTORE



7



146002800

GREY GEAR Z=13/90 FOR RATIOMOTOR P124  
GREY GEAR Z=13/90 FOR RATIOMOTOR P124



8

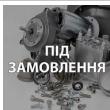

9121.039

STEEL PIN FOR RATIOMOTOR GEARMAGIC  
STEEL PIN FOR RATIOMOTOR GEARMAGIC



9

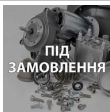

11003037

MOTOR FOR RATIOMOTOR ASSY.  
MOTOR FOR RATIOMOTOR ASSY.



10



9121.044

ANTIVIBRATION FOR MOTOR  
ANTIVIBRANTE X MOTORE



11



148380200

BAKELIZZATE WASHER D=5,5  
BAKELIZZATE WASHER D=5,5



12



9121.046

BRONZE SINTERED BUSH FOR MOTORRATIOMOT.  
BRONZE SINTERED BUSH FOR MOTOR RATIOMOT.



13



11026258

GREY RATIOMOTOR CASING WITH TUBE ASSY.  
GREY RATIOMOTOR CASING WITH TUBE ASSY.

## Model Machine

MACSAE156

AULIKA FOCUS (10004472 )



14



11005214

MOTOR FOR RATIOMOTOR ASSY.

*MOTOR FOR RATIOMOTOR P124 ASSY*



# Model Machine

MACSAE156

AULIKA FOCUS (10004472 )

MACSAE156.T.0009



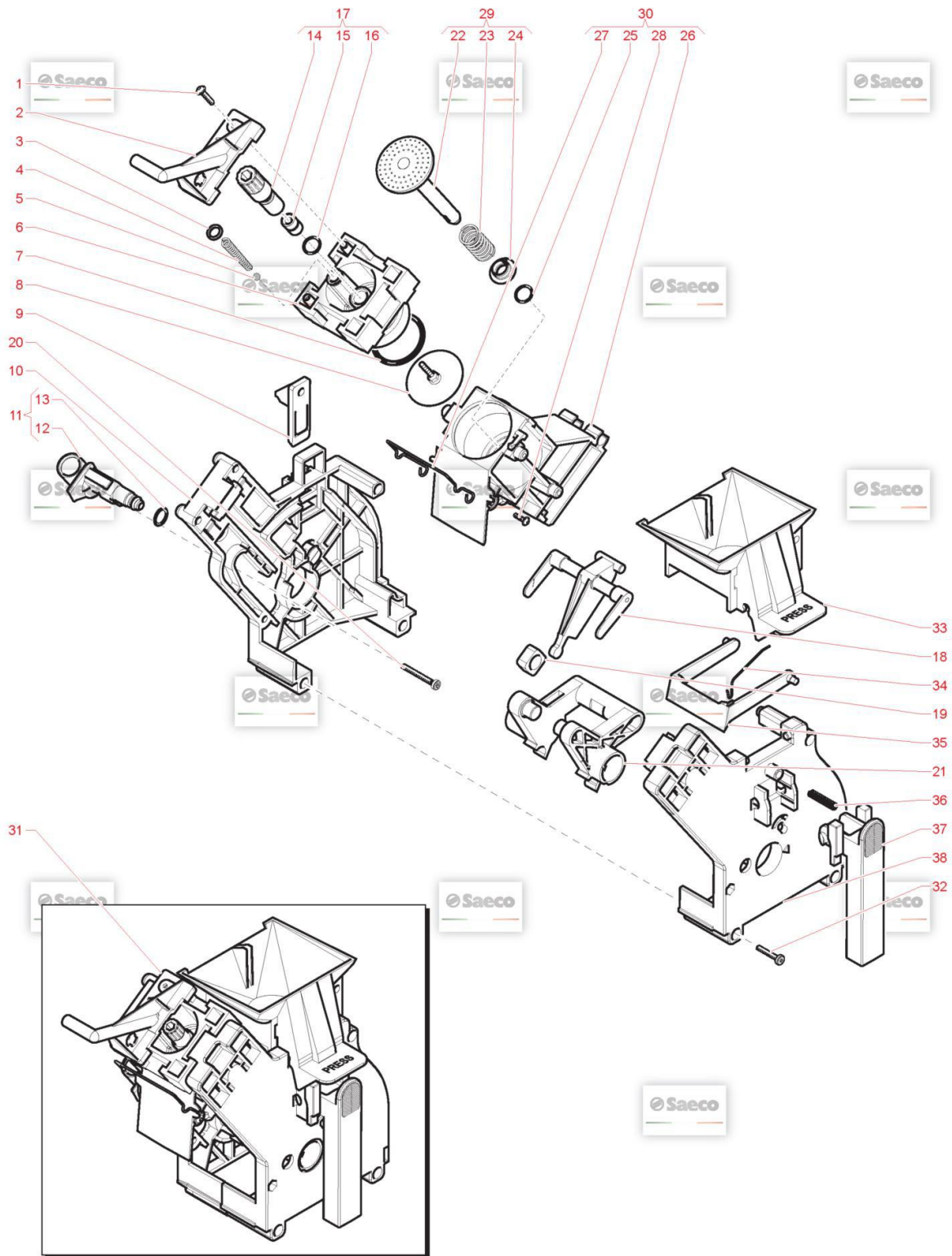























TAVOLA NR. 9 - ARTICOLO AULIKA FOCUS ( 10004472 )



## Model Machine

MACSAE156











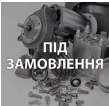

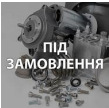













AULIKA FOCUS (10004472 )

Web	Pos.	Foto	Item - Replace by	Description
				<i>Press - CTRL + CLICK go to item in a new window Натисніть - Ctrl + права кнопка миші щоб відкрити запчастину в новому вікні</i>
	1		12002170	SCREW TCB TORX 10 3X16 PLAST SS VITE TCB 3X16 TORX 10 PLAST.INOX
	2		11003789	BLACK COFF.OUTLET SLEEVE BREWUNIT ROYAL BLACK COFF.OUTLET SLEEVE BREW UNIT ROYAL,AULIKA MAGIC SAECO
	3		11021334	BLK COUNTERPISTON SEAL DE=11 DI=8 SP=1,4 BLK COUNTERPISTON SEAL DE=11 DI=8 SP=1,4
	4		9161.222	SS.CONICAL SPRING MOLLA CONICA
	5	 ПІД ЗАМОВЛЕННЯ	421944034451	BOROSILICATE SPHERE D.5 MM BOROSILICATE SPHERE D.5
	6		11003796	BLACK BREW UNIT COUNTERPISTONM5000 BLACK BREW UNIT COUNTERPISTON M5000
	7		NM01.044	OR ORM 0320-40 SILICONE PTFE/FDA OR ORM 0320-40 SILICONE PTFE
	8		9160.075	PERCOLATOR DE=35,8 ELFO ASSY. PERCOLATOR DE=35,8 ELFO ASSY.
	9	 ПІД ЗАМОВЛЕННЯ	11004114	BLACK BREW UNIT COUPLING PLATE BLACK BREW UNIT COUPLING PLATE
	10	 ПІД ЗАМОВЛЕННЯ	421941158532	BLACK BREW UNIT REAR PLATE V2M5000 BLACK BREW UNIT REAR PLATE V2 M5000
	11		20000440	BLACK WATER INLET SLEEVE BREWUNIT ASSY. BLACK WATER INLET SLEEVE BREW UNIT ASSY.
	12		9161.064.050	BLACK WATER INLET SLEEVE BREWUNIT ROYAL BLACK WATER INLET SLEEVE BREW UNIT ROYAL
	13		NM02.007	OR 2025 IN TERMOIL OR 2025 TERMOIL

## Model Machine

MACSAE156













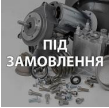







AULIKA FOCUS (10004472 )

	14		147472650	PIN BLACK FOR PERCOLATOR <i>PIN BLACK FOR PERCOLATOR</i>
	15		NF11.067	BRASS INSERT FOR PERCOLATOR LOCKING PIN <i>BRASS INSERT FOR PERCOLATOR LOCKING PIN</i>
	16		140324461	OR ORM 0060-20 TERMOIL <i>OR ORM 0060-20 IN TERMOIL</i>
	17		227470150	PIN BLACK ASS.FOR PERCOLATOR <i>PIN BLACK ASS.FOR PERCOLATOR</i>
	18		11003078	BLACK CONNECTING ROD BREW UNIT8GR. <i>BLACK CONNECTING ROD BREW UNIT 8GR.</i>
	19		9161.094.050	BLACK BREW UNIT DRILLED BLOCK <i>BLACK BREW UNIT DRILLED BLOCK</i>
	20		12000550	CAMOPI3 TCB TORX 10 3X25 PLAST.SS <i>SCREW TCB TORX 10 3X25 PLAST.SS</i>
	21		9161.066.050	BLACK BREW UNIT ELBOW SHAFT M5000 <i>BLACK BREW UNIT ELBOW SHAFT M5000</i>
	22		11003077	BLK BREW UNIT INTEGRAL PISTON8GR.ASSY. <i>BLK BREW UNIT INTEGRAL PISTON 8GR.ASSY.</i>
	23		9161.198	SS.8GR.BREW UNIT PISTON SPRING <i>SS.8GR.BREW UNIT PISTON SPRING</i>
	24		9161.191	WHITE 8GR.-12GR.BREW UNIT PISTON BUSH <i>BOCCOLA X PISTONE NEUTRO</i>
	25		NM02.018	OR ORM 0090-25 TERMOIL <i>OR ORM 0090-25 TERMOIL</i>
	26		421944014611	BLK COF.CONTAIN.BREW UNIT V2 M5000 ASSY. <i>BLK COF.CONTAIN.BREW UNIT V2 M5000 ASSY.</i>
	27		11001556	SS BREW UNIT SPRING H=49 SMART <i>SS BREW UNIT SPRING H=49 SMART</i>

## Model Machine

MACSAE156

AULIKA FOCUS (10004472 )

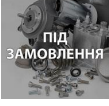
	28		129912521	SCREW TCBR TORX 10 3,5X14 PLAST.SS SCREW TCBR TORX 10 3,5X14 PLAST.SS
	29		11023086	BLK 8GR.BREW UNIT NTEGR.PISTONGEN.ASSY. BLK 8GR.BREW UNIT NTEGR.PISTON GEN.ASSY.
	30		11004570	BLACK BREW UNIT COFFEE CONT.P124 ASSY. AS.CONT.CAF.GRUP.8G.P124 NER.
	31		11003800	BLACK BREW UNIT BLACK BREW UNIT MAGIC/ROYAL
	32		12000897	SCREW TCB TORX 10 3,5X20 PLAST.SS SCREW TCB TORX 10 3,5X20 PLAST.SS
	33		11003795	BLACK HOPPER COFF.BREW UNIT S/SCR.M5000 BLACK HOPPER COFF.BREW UNIT S/SCR.M5000
	34		9161.046	ПРУЖИНА ВОРОНКИ ЗАВАРОЧНОГО БЛОКА ДЛЯ КОФЕМАШИН PHILIPS ... MOLLA X RASATORE GRUPPO
	35		11004161	BLACK SCRAPER FOR BREW UNIT M5000 BLACK SCRAPER FOR BREW UNIT M5000
	36		11003793	BLACK BREW UNIT FRONT PLATE M5000 BLACK BREW UNIT FRONT PLATE M5000
	37		9161.045	SS BREW UNIT HANDGRIP SPRING M5000 MOLLA X IMPUGNATURA GRUPPO
	38		11003791	BLACK BREW UNIT HANDGRIP M5000 BLACK BREW UNIT HANDGRIP M5000

# Model Machine

MACSAE156

AULIKA FOCUS (10004472 )

MACSAE156.T.0010

TAVOLA NR. 10 - ARTICOLO AULIKA FOCUS ( 10004472 )

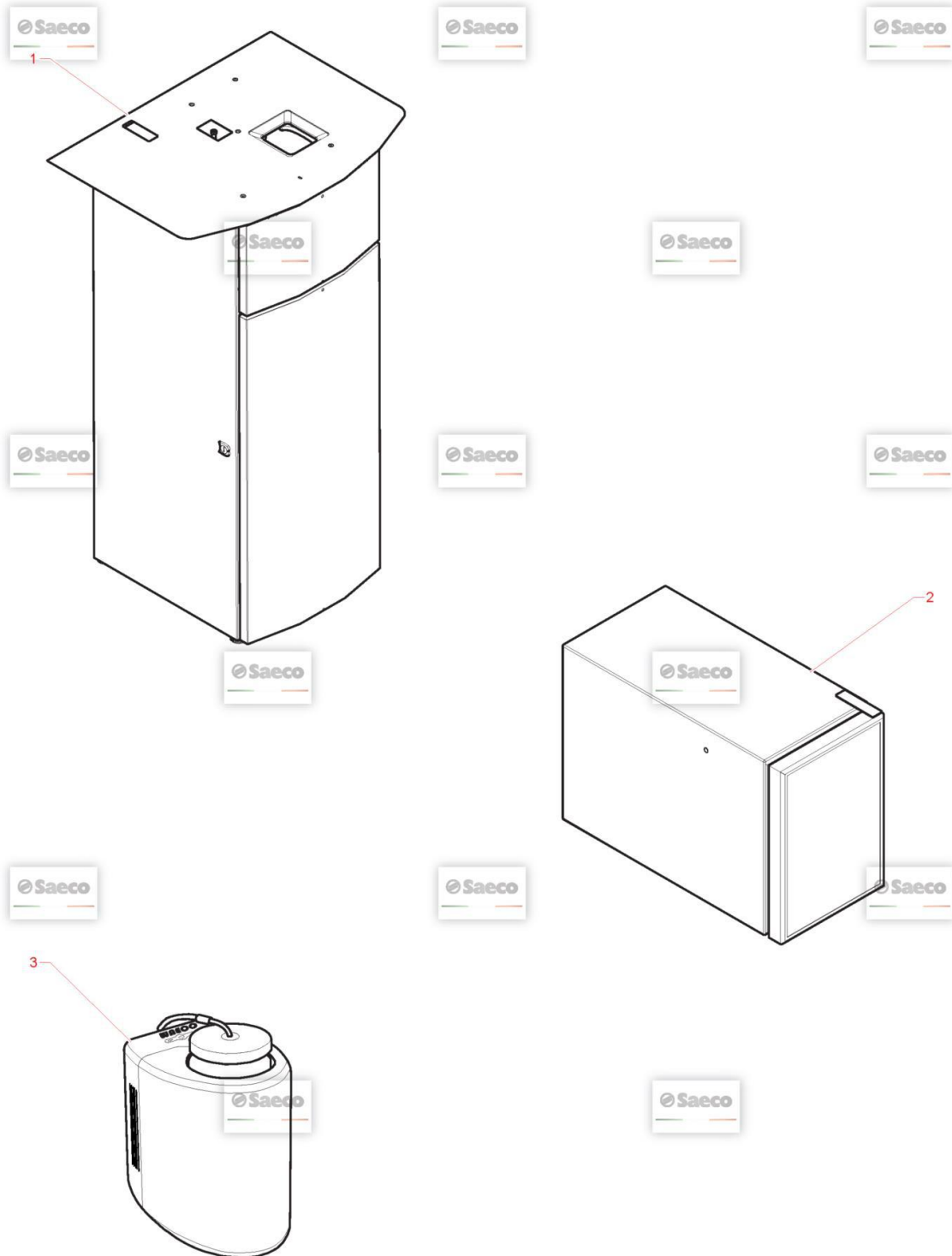

## Model Machine

MACSAE156

AULIKA FOCUS (10004472 )

Web Pos. Foto Item - Replace by Description



*Press - CTRL + CLICK go to item in a new window  
Натисніть - Ctrl + права кнопка миші щоб відкрити запчастину в новому вікні*



1

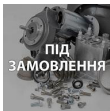

10005004

VE CABINET AULIKA-ROYAL-AMBRABLK-SIL  
VE CABINET AULIKA-ROYAL-AMBRABLK-SIL



2

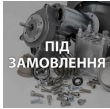

21001800

ACC PR FRIGO ASTRA 220/230 50/60 SCH BLK  
ACC PR FRIGO ASTRA 220/230 50/60 SCH BLK



3

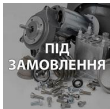

21001820

ACC PR MANTENITORE 100/240V 50-60HZ BLK  
ACC PR MANTENITORE 100/240V 50-60HZ BLK