

# Model Machine

MACSAE159

ATLANTE 700 EVO

MACSAE159.T.0001



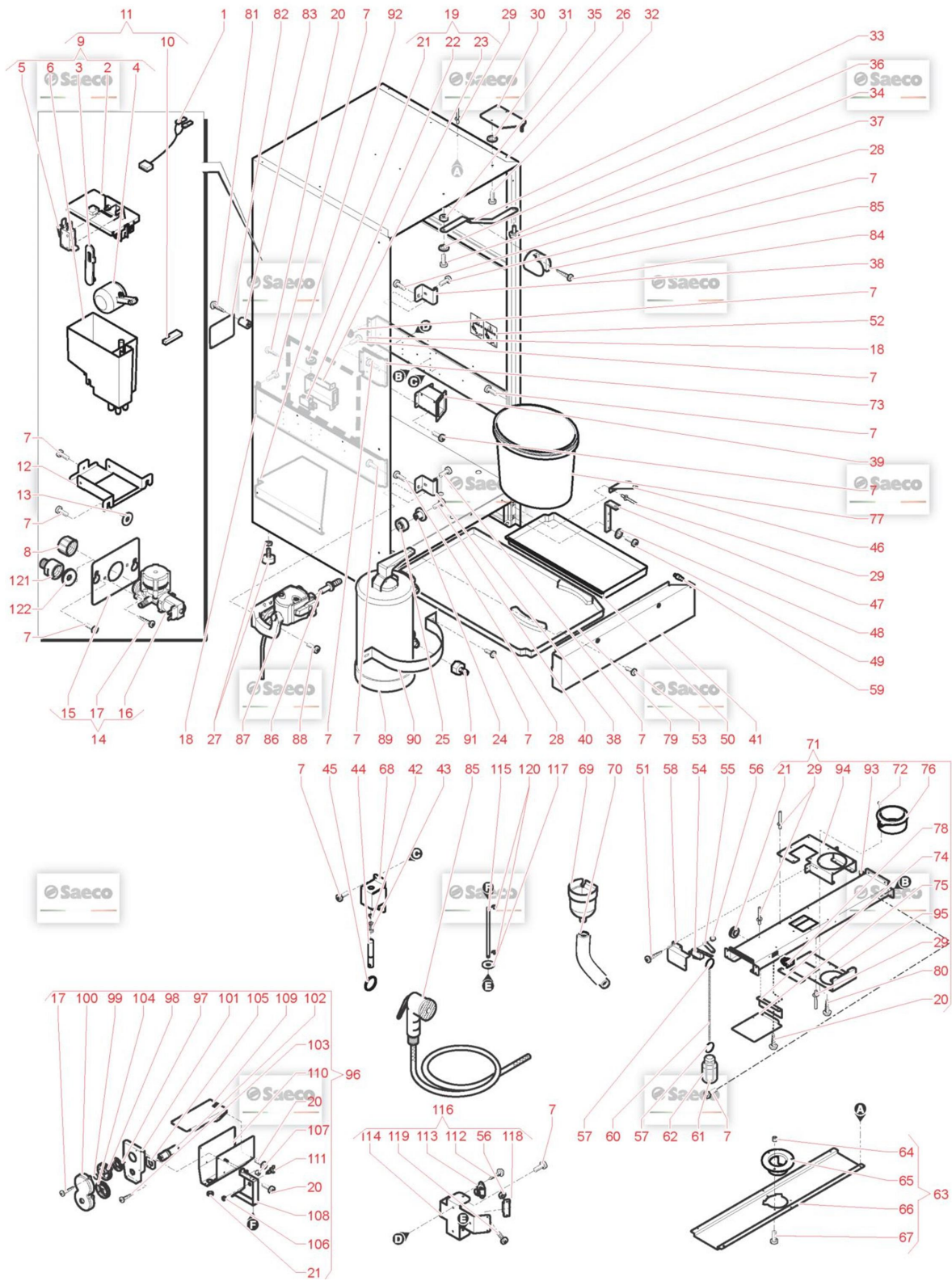









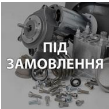









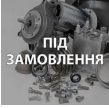

TAVOLA NR. 1 - ARTICOLO ATLANTE 700 EVO



## Model Machine

MACSAE159



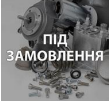







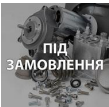

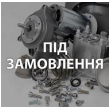

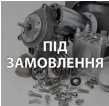











ATLANTE 700 EVO

Web	Pos.	Foto	Item - Replace by	Description
				<i>Press - CTRL + CLICK go to item in a new window Натисніть - Ctrl + права кнопка миші щоб відкрити запчастину в новому вікні</i>
	1		11009582	CABLAGGIO AIR BREAK SG650 CABLAGGIO AIR BREAK SG650
	2		9111.623	LID TANK AIR BREAK COPERCHIO X SERBATOIO AIR BREAK
	3		9111.512	LEVER FOR WATER TANK LEVER FOR WATER TANK
	4		9111.508	FLOAT FOR AIR BREAK BOWL FLOAT FOR AIR BREAK BOWL
	5		NE05.062	MICROSWITCH + WHEEL MICROINTERRUTTORE C/ROTELLA
	6		9111.622	TANK AIR BREAK SERBATOIO AIR BREAK
	6		9111.641	TANK AIR BREAK SERBATOIO AIR BREAK C/FORO
	7		U127.011	SCREW TAPT.TCB M5,0X8 DIN 7500C SCREW TAPT.TCB M5,0X8 DIN 7500C
	8		NV03.002	CAP 3/4 "KAPSTO 800R 3/4" "CAP 3/4 "KAPSTO 800R 3/4""
	9		9110.102	WATER TANK ASS. AIR-BREAK SG NEW ASS.VASCETTA AIR-BREAK SG NEW
	9		9110.134	WATER TANK ASS. AIR-BREAK SG700 M. WATER TANK ASS. AIR-BREAK SG700 M.
	10		9111.632	RUBBER FOR AIR BREAK RUBBER FOR AIR BREAK

## Model Machine

MACSAE159











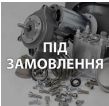

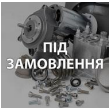













ATLANTE 700 EVO

	11		<b>11009786</b>	ASS. AIR/BREAK ASSEMBLE SG650 <i>ASS. AIR/BREAK ASSEMBLE SG650</i>
	11		<b>11010386</b>	ASS. AIR/BREAK ASSEMBLE SG650INSTANT <i>ASS. AIR/BREAK ASSEMBLE SG650 INSTANT</i>
	12		<b>11008247</b>	AIR BREAK SUPPORT <i>AIR BREAK SUPPORT</i>
	13		<b>9111.501</b>	INSULATION WASHER <i>INSULATION WASHER</i>
	14		<b>9110.136.00P</b>	ASS.ELECTROVALVE INLET WATER 24V <i>ASS.ELECTROVALVE INLET WATER 24V</i>
	15		<b>9111.670</b>	OMEGA SUPPORT ELECTROVALVE <i>OMEGA SUPPORT ELECTROVALVE</i>
	16		<b>9121.057.00P</b>	SAFETY ELECTROVALVE 24V DC <i>SAFETY ELECTROVALVE 24V DC</i>
	17		<b>U110.003</b>	SCREW AUT.TCB 3,5X9,5 DIN 7981F <i>VITE AUT.TCB 3,5X9,5 DIN 798</i>
	18		<b>11007662</b>	CROSS BEAM ASS. R/L SIDES SG650 <i>CROSS BEAM ASS. R/L SIDES SG650</i>
	19		<b>11008480</b>	ASS.INTERBLOCK <i>ASS.INTERBLOCK</i>
	20		<b>U110.005</b>	SCREW AUT.TCB 3,9X9,5 DIN 7981F <i>VITE AUT.TCB 3,9X9,5 DIN 798</i>
	21		<b>NE16.002</b>	GROMMET D.11X20,5XH.7 <i>GROMMET D.11X20,5XH.7</i>
	22		<b>NE05.039</b>	BIPOLAR MICROSWITCH <i>MICROINTERRUTTORE BIPOLARE</i>
	23		<b>11008473</b>	BOX <i>BOX</i>

## Model Machine

MACSAE159















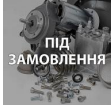

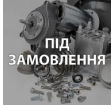





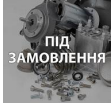

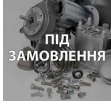
ATLANTE 700 EVO

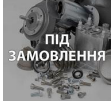
	24		<b>11006477</b>	FS400 DOOR PIVOT FOR WHEEL <i>FS400 DOOR PIVOT FOR WHEEL</i>
	25		<b>11003474</b>	FS400 DOOR WHEEL <i>FS400 DOOR WHEEL</i>
	26		<b>11007638</b>	ASS.CASING TO RIVET SG650 <i>ASS.CASING TO RIVET SG650</i>
	27		<b>NV01.002</b>	FOOT D.34 H.35 WITH NUT M10 <i>PIEDINO D.34 H.35 CON DADO M</i>
	28		<b>U046.005</b>	SCREW TE M5,0X10 WITH WASHER <i>SCREW TE M5,0X10 WITH WASHER</i>
	29		<b>12000962</b>	MULTIGRIP RIVETS 4.8X11 <i>MULTIGRIP RIVETS 4.8X11</i>
	30		<b>11008614</b>	ASS.UPPER HINGE PIVOT <i>ASS.UPPER HINGE PIVOT</i>
	31		<b>U207.013</b>	PLAIN WASHER 6.5X18 UNI 6592 GALV <i>PLAIN WASHER 6.5X18 UNI 6592 GALV</i>
	32		<b>U046.006</b>	SCREW TE M6,0X10 WITH WASHER <i>SCREW TE M6,0X10 WITH WASHER</i>
	33		<b>11009898</b>	STOP FOR DOOR SG650 <i>STOP FOR DOOR SG650</i>
	34		<b>0871.126</b>	SCREW FOR LOCK ROD <i>SCREW FOR LOCK ROD</i>
	35		<b>11008644</b>	LOCK PIN <i>LOCK PIN</i>
	36		<b>11013032</b>	SPACER FOR DOOR BRAKE <i>SPACER FOR DOOR BRAKE</i>
	37		<b>U043.016</b>	SCREW TCBC M5,0X16 UNI 7687 GALV. <i>SCREW TCBC M5,0X16 UNI 7687 GALV.</i>

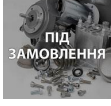
## Model Machine

MACSAE159

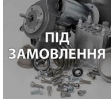









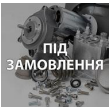

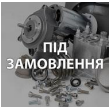













ATLANTE 700 EVO

	38		11008671	ROD LOCK HOOKUP <i>ROD LOCK HOOKUP</i>
	39		11009123	ASS.CHANNEL FAN ASPIRATION <i>ASS.CHANNEL FAN ASPIRATION</i>
	40		12000780	SCREW TSPC M4,0X20 UNI 7688 GALV. <i>SCREW TSPC M4,0X20 UNI 7688 GALV.</i>
	41		11032753	SKIRTING BAND ASSEMBLY ATL700EVO <i>SKIRTING BAND ASSEMBLY ATL700 EVO</i>
	42		U701.003	SNAP RING 7 UNI 7434 <i>ANELLO ELASTICO 7 UNI 7434</i>
	43		9111.355	SPRING FOR CHANGE BUTTON <i>MOLLA X PULSANTE RENDIRESTO</i>
	44		11009672	PIN FIXING REVOLVING PLATE <i>PIN FIXING REVOLVING PLATE</i>
	45		1431.003	KEYHOLDER RING <i>KEYHOLDER RING</i>
	46		11008669	LOWER HINGE PLATE SG650 <i>LOWER HINGE PLATE SG650</i>
	47		11008668	LOWER HINGE SG650 <i>LOWER HINGE SG650</i>
	48		U208.009	TOOTHED WASHER 8,4X15 UNI 3703 <i>TOOTHED WASHER 8,4X15 UNI 3703</i>
	49		12001174	SCREW TCEI M8X35 UNI 5931 ZIN <i>SCREW TCEI M8X35 UNI 5931 ZIN</i>
	50		11009852	BOTTOM TUB RIGHT SG650 <i>BOTTOM TUB RIGHT SG650</i>

## Model Machine

MACSAE159





























ATLANTE 700 EVO

	51		<b>U109.011</b>	SCREW AUT.TCB 3,9X9,5 DIN 7981C <i>SCREW AUT.TCB 3,9X9,5 DIN 7981 C</i>
	52		<b>15004269</b>	ADHESIVE NUMBER OF CYCLES CAPSULES <i>ADHESIVE NUMBER OF CYCLES CAPSULES</i>
	53		<b>U043.008</b>	SCREW TCBC M5,0X10 UNI 7687 GALV. <i>SCREW TCBC M5,0X10 UNI 7687 GALV.</i>
	54		<b>NE05.041</b>	MICROSWITCH <i>MICROINTERRUTTORE</i>
	55		<b>9111.407</b>	MICRO PLATE <i>MICRO PLATE</i>
	56		<b>U324.005</b>	NUT M3 FLANGED INDENTED BASE <i>DADO M3 FLANGIATO BASE DENTELLATA</i>
	57		<b>9111.148</b>	ELASTIC RING FOR FLOAT <i>ANELLO ELASTICO X GALLEGGIANTE</i>
	58		<b>11032614</b>	SUPPORT MICRO FLOATING <i>SUPPORT MICRO FLOATING</i>
	59		<b>NF11.041</b>	PIN FOR SKIRTING <i>PIN FOR SKIRTING</i>
	60		<b>11009608</b>	CHAIN FOR AFLOAT L.250MM SG650 <i>CHAIN FOR AFLOAT L.280MM SG650</i>
	61		<b>9111.147</b>	COUNTERWEIGHT FOR FLOAT <i>CONTRAPPESO X GALLEGGIANTE</i>
	62		<b>9111.130</b>	FLOAT FOR DISCHARGE LEVEL <i>FLOAT FOR DISCHARGE LEVEL</i>
	63		<b>11008255</b>	UPPER CROSS ASS. <i>UPPER CROSS ASS.</i>
	64		<b>U324.003</b>	NUT M5 FLANGED INDENTED BASE <i>NUT M5 FLANGED INDENTED BASE</i>

## Model Machine

MACSAE159

















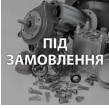





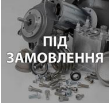

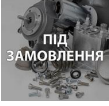
ATLANTE 700 EVO

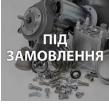
	65		11008267	FLANGIA SUPERIORE DI ROTAZIONE <i>FLANGIA SUPERIORE DI ROTAZIONE</i>
	66		11007667	ROOF CROSS BEAM X PLATE REVOLVING SG650 <i>ROOF CROSS BEAM X PLATE REVOLVING SG650</i>
	67		U043.015	SCREW TCBC M5,0X12 UNI 7687 GALV. <i>SCREW TCBC M5,0X12 UNI 7687 GALV.</i>
	68		11009671	PIN SUPPORT FIXING 90° <i>PIN SUPPORT FIXING 90°</i>
	69		11009607	TUBE CONVEYOR LIQUIDS DISCHARGE CENTRAL <i>TUBE CONVEYOR LIQUIDS DISCHARGE CENTRAL</i>
	70		11014050	ГНУЧКИЙ ШЛАНГ D.21 L.250MM <i>FLEXIBLE TUBE D.21 L.250MM</i>
	71		11031028	LOWER CROSS <i>LOWER CROSS</i>
	72		9991.093	MAGNET D=9,5 X H=1,5 <i>MAGNETE D.9,5 X 1,5</i>
	73		11033450	FIXING PLATE SIDEBUCKET <i>FIXING PLATE SIDEBUCKET</i>
	74		11008476	COVER RINFORCE <i>COVER RINFORCE</i>
	75		11008477	COVER <i>COVER</i>
	76		11008260	LOWER BUSH OF ROTATION <i>LOWER BUSH OF ROTATION</i>
	77		12002042	BUCKET UTILPLASTIC 328X250X300BLACK <i>BUCKET UTILPLASTIC 328X250X300 BLACK</i>
	78		NE13.046	SOCKET 2 POLE + EARTH 08168600W <i>SOCKET 2 POLE + EARTH 08168600W</i>

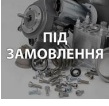
## Model Machine

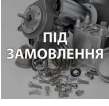
MACSAE159

ATLANTE 700 EVO











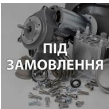

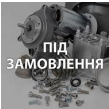

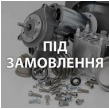

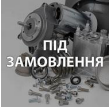

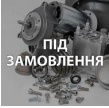





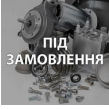

	79		<b>11032653</b>	BOTTOM TUB LEFT SG650 <i>BOTTOM TUB LEFT SG650</i>
	80		<b>U116.006</b>	SCREW AUT.PT TCB 3,5X12 WN 1441 ZNP <i>VITE AUT.PT TCB 3,5X12 WN 1441 ZNP</i>
	81		<b>129516803</b>	SCREW TCB3,5X19 DIN 7981 NICK <i>SCREW TCB3,5X19 DIN 7981 NICK</i>
	82		<b>11012508</b>	AIR DEFLECTOR PLATE ATLANTE <i>AIR DEFLECTOR PLATE ATLANTE</i>
	83		<b>11010659</b>	SPACER FOR DEFLECTOR <i>SPACER FOR DEFLECTOR</i>
	84		<b>U109.005</b>	SCREW AUT.TCB 3,5X16 DIN 7981C <i>VITE AUT.TCB 3,5X16 DIN 798</i>
	85		<b>12001922</b>	ЛІЙКА ДУШУ С ШЛАНГОМ В НАБОРІ <i>ASS.DOCSETTA C/TUBO RACCORDATO E SUPP.</i>
	86		<b>12001921</b>	RUBBER HOLDER 8MM JOHN GUEST <i>RUBBER HOLDER 8MM JOHN GUEST</i>
	87		<b>12001920</b>	HEAD FILTRE BRITA JOHNGUEST 8MM <i>HEAD FILTRE BRITA JOHNGUEST 8MM</i>
	88		<b>U043.014</b>	SCREW TCBC M5,0X20 UNI 7687 GALV. <i>SCREW TCBC M5,0X20 UNI 7687 GALV.</i>
	89		<b>1414.001</b>	WATER SOFTENER 8 L <i>ACC WATER SOFTENER 8 L</i>
	90		<b>11011627</b>	BAND FOR PURIFIER FIXING SG650 <i>BAND FOR PURIFIER FIXING SG650</i>
	91		<b>NR07.059</b>	STD TOOTHED CONNECTOR F3/8X09 <i>RESCA STANDARD F 3/8X09</i>

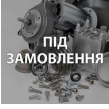

## Model Machine

MACSAE159



























ATLANTE 700 EVO

	92		11013056	ATLANTE DECALCIFY RAISED <i>ATLANTE DECALCIFY RAISED</i>
	93		11031046	OMEGA <i>OMEGA</i>
	94		11031719	SUPPORT ROTATION <i>SUPPORT ROTATION</i>
	95		11031048	PLATE SUPPORT CENTER ROTATIONCAPS <i>PLATE SUPPORT CENTER ROTATIONCAPS</i>
	96		11031757	ASSEMBLY CONTAINER SUPPORT SIDE <i>ASSEMBLY CONTAINER SUPPORT SIDE</i>
	97		11001660	PROTECTION BUSH <i>BOCCOLA PROTEZIONE</i>
	98		9111.694	JOINT WITH GEAR <i>GIUNTO CON INGRANAGGIO</i>
	99		11007273	DISC FOR THICKNESS <i>DISC FOR THICKNESS</i>
	10001		9111.687.A20	GEAR COVER <i>COPERCHIO INGRANAGGI</i>
	1010		11031705	PLATE SUPPORT 5° CAPS CONTAINER <i>PLATE SUPPORT 5° CAPS CONTAINER</i>
	1020		9121.106.00P	SUGAR RATIONMOTOR 24V DC <i>MOTORIDUTTORE ZUCCHERO 24V D.C.</i>
	1030		U116.005	SCREW AUT.PT TCB 3,0X8 WN 1441 <i>VITE AUT.PT TCB 3,0X8 WN 1441 ZNP</i>
	1040		9111.695	GEAR Z40 <i>INGRANAGGIO Z 40</i>
	1050		11001570	SPACER MOTOR LIP SUGAR <i>SPACER MOTOR LIP SUGAR</i>

## Model Machine

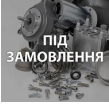
MACSAE159

ATLANTE 700 EVO

	1060		NF11.025	RUBBER RING FOR RAPID COUPLING <i>ANELLO IN GOMMA X INNESTO RA</i>
	1070		U324.006	NUT M4 FLANGED INDENTED BASE <i>NUT M4 FLANGED INDENTED BASE</i>
	1080		11031709	ROTATION PLATE SUPPORT 5° CONTAINER <i>ROTATION PLATE SUPPORT 5° CONTAINER</i>
	1090		11031707	CENTRAL PLATE SUPPORT 5° CONTAINER <i>CENTRAL PLATE SUPPORT 5° CONTAINER</i>
	1100		11031703	5° CONTAINER SUPPORT <i>5° CONTAINER SUPPORT</i>
	1110		12001940	PIN <i>PIN</i>
	1120		U110.004	SCREW AUT.TCB 3,5X6,5 DIN 7981F <i>VITE AUT.TCB 3,5X6,5 DIN 7981 F NIK</i>
	1130		NF11.023	RECEPTACLE FOR RAPID COUPLING <i>RICETTACOLO X INNESTO RAPIDO</i>
	1140		11031718	5° CONTAINER SUPPORT ROTATION <i>5° CONTAINER SUPPORT ROTATION</i>
	1150		0894.140	PIN FOR SHELF SUGAR <i>PIN FOR SHELF SUGAR</i>
	1160		11031861	SUPPORT CONTAINER SIDE <i>SUPPORT CONTAINER SIDE</i>
	1170		U207.009	PLAIN WASHER 5,5X15 UNI 6593 GA <i>PLAIN WASHER 5,5X15 UNI 6593 GA</i>
	1180		9991.182	MAGNET FOR DOOR SG700 <i>MAGNET FOR DOOR SG700</i>
	1190		U043.028	SCREW TCBC M3,0X10 UNI 7687 GALV. <i>SCREW TCBC M3,0X10 UNI 7687 GALV.</i>

## Model Machine

MACSAE159

ATLANTE 700 EVO



1200



U701.006

SNAP RING 3,2 UNI 7434  
*ANELLO ELASTICO 3,2*



1210

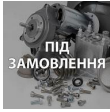

9991.175

CONN. FOR SOLENOID VALVE POWER  
*CONN. FOR SOLENOID VALVE POWER*



1220

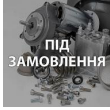

0870.058

SEAL FOR SOLENOID VALVE  
*SEAL FOR SOLENOID VALVE*

# Model Machine

MACSAE159

ATLANTE 700 EVO

MACSAE159.T.0002

TAVOLA NR. 2 - ARTICOLO ATLANTE 700 EVO

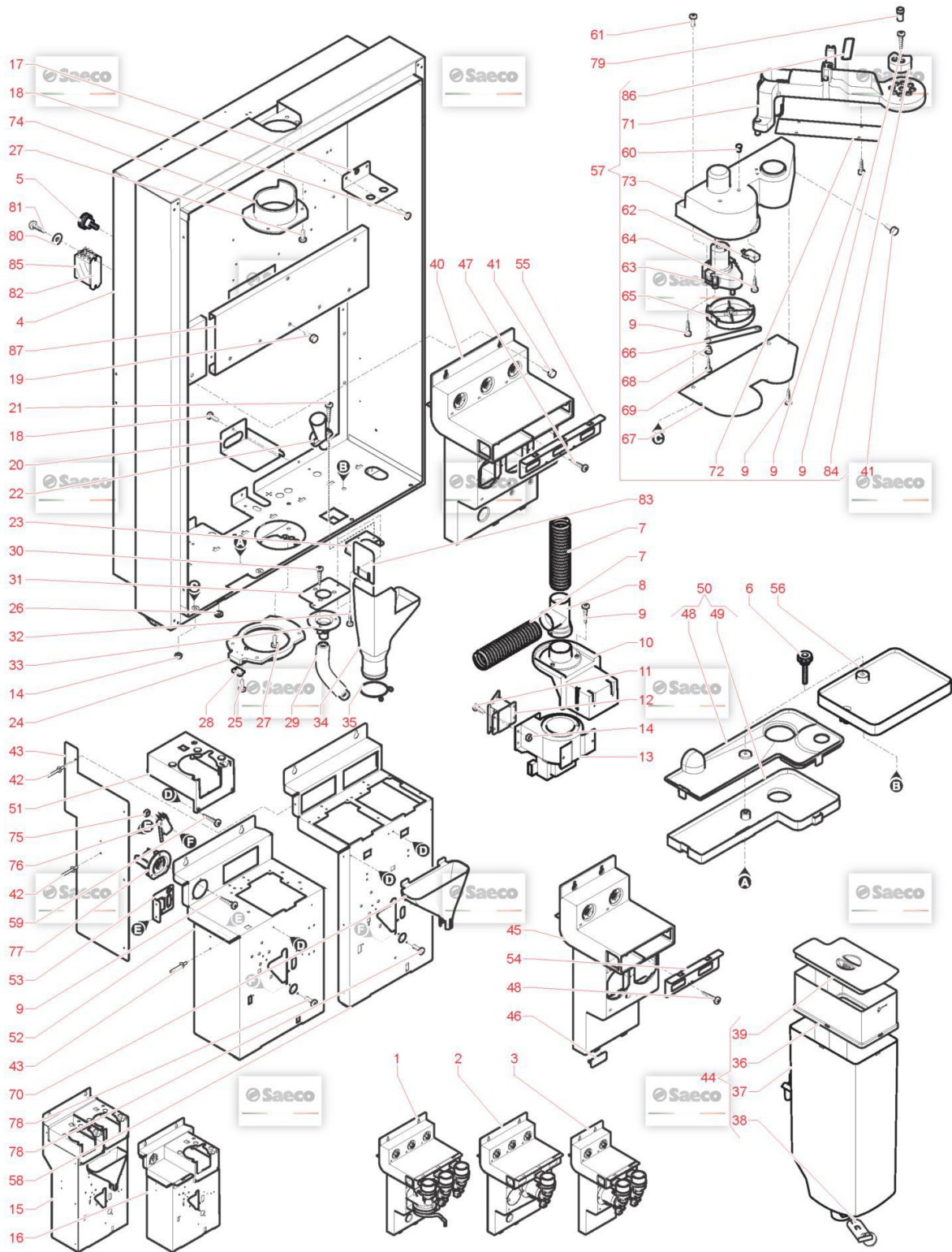

## Model Machine

MACSAE159

ATLANTE 700 EVO

Web Pos. Foto Item - Replace by Description



Press - CTRL + CLICK go to item in a new window

Натисніть - Ctrl + права кнопка миші щоб відкрити запчастину в новому вікні



1

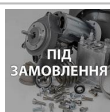

11008243

ASS. MODULE 3 MOTOR  
ASS. MODULE 3 MOTOR



2

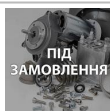

11010385

MIXER MODULE ASS. SG650 INSTANT  
MIXER MODULE ASS. SG650 INSTANT



3

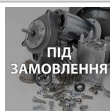

11008258

ASS. MODULE 2 MOTOR  
ASS. MODULE 2 MOTOR



4

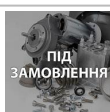

11032480

REVOLVING PLATE SKIN ATL700  
REVOLVING PLATE SKIN ATL700



5

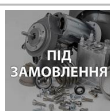

12002030

KNOB D.18 M5X10  
KNOB D.18 M5X10



6

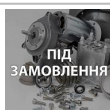

12002032

KNOB D.18 M5X40  
VOLANTINO ZIGRINATO D.18 M5X40



7



0894.009

SPIRAL TUBE D.32 L=280 MM  
SPIRAL TUBE D.32 L=760 MM



7

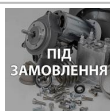

1843.015

SPIRAL TUBE L.500  
SPIRAL TUBE L.500



8



9111.640.060

TUBE CONNECTOR  
TUBE CONNECTOR



9



U116.006

SCREW AUT.PT TCB 3,5X12 WN 1441 ZNP  
VITE AUT.PT TCB 3,5X12 WN 1441 ZNP



10

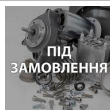

9111.732.A20

SUPPORT  
SUPPORT



11



U043.015

SCREW TCBC M5,0X12 UNI 7687 GALV.  
SCREW TCBC M5,0X12 UNI 7687 GALV.



12















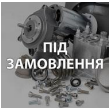













11009123

ASS.CHANNEL FAN ASPIRATION  
ASS.CHANNEL FAN ASPIRATION

## Model Machine

MACSAE159

















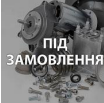





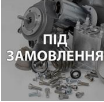

ATLANTE 700 EVO

	13		<b>9121.198.00A</b>	ВЕНТИЛЯТОР ВИТЯЖКИ 07 120X100X100 SAECO 9121.198.00A <i>VENTILATORE CENTRIFUGO CAP 07</i>
	14		<b>U324.003</b>	NUT M5 FLANGED INDENTED BASE <i>NUT M5 FLANGED INDENTED BASE</i>
	15		<b>11008263</b>	ASS. MODULE 1 GRIND <i>ASS. MODULE 1 GRIND</i>
	15		<b>11032215</b>	MODULE 1 GRIND 220/60 <i>MODULE 1 GRIND 220/60</i>
	16		<b>11008261</b>	ASS. MODULE COFFEE 1 GRIND <i>ASS. MODULE COFFEE 1 GRIND</i>
	16		<b>11030336</b>	ASS. MODULE COFFEE 1 GRIND TTT230V <i>ASS. MODULE COFFEE 1 GRIND TTT230V</i>
	17		<b>11009909</b>	SUPPORT COFFEE CONTAINER SG650 <i>SUPPORT COFFEE CONTAINER SG650</i>
	18		<b>U127.011</b>	SCREW TAPT.TCB M5,0X8 DIN 7500C <i>SCREW TAPT.TCB M5,0X8 DIN 7500C</i>
	19		<b>129720902</b>	TE SCREW M5X10 UNI 5739 ZNP <i>TE SCREW M5X10 UNI 5739 ZNP</i>
	20		<b>11010729</b>	TUBE SUPPORT SG650 <i>TUBE SUPPORT SG650</i>
	21		<b>U110.003</b>	SCREW AUT.TCB 3,5X9,5 DIN 7981F <i>VITE AUT.TCB 3,5X9,5 DIN 798</i>
	22		<b>9111.527.050</b>	TUBE CONVEYOR COFFEE DISCHARGE <i>TUBE CONVEYOR COFFEE DISCHARGE</i>
	23		<b>11032516</b>	DUMPING SUPPORT <i>DUMPING SUPPORT</i>
	24		<b>11008265</b>	LOWER FLANGE OF ROTATION <i>LOWER FLANGE OF ROTATION</i>

## Model Machine

MACSAE159



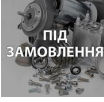















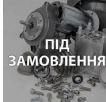

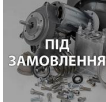





ATLANTE 700 EVO

	25		<b>U116.005</b>	SCREW AUT.PT TCB 3,0X8 WN 1441 VITE AUT.PT TCB 3,0X8 WN 1441 ZNP
	26		<b>NE16.002</b>	GROMMET D.11X20,5XH.7 GROMMET D.11X20,5XH.7
	27		<b>U044.011</b>	SCREW TSPC M5,0X16 UNI 7688 GALV. SCREW TSPC M5,0X16 UNI 7688 GALV.
	28	 ПІД ЗАМОВЛЕННЯ	<b>1863.649</b>	REED FOR DOOR REED FOR DOOR
	29		<b>11013949</b>	ГНУЧКИЙ ШЛАНГ D.21 L.350 MM ГНУЧКИЙ ШЛАНГ D.21 L.350 MM FLEXIBLE TUBE D.21 L.350MM
	29	 ПІД ЗАМОВЛЕННЯ	<b>11021498</b>	FLEXIBLE TUBE D.11,5-14,5 L.360MM FLEXIBLE TUBE D.11,5-14,5 L.360MM
	30		<b>U111.005</b>	SCREW AUT.TSP 3,9X9,5 DIN 7982C SCREW AUT.TSP 3,9X9,5 DIN 7982 C
	31	 ПІД ЗАМОВЛЕННЯ	<b>11032515</b>	FUNNEL SUPPORT FUNNEL SUPPORT
	32		<b>U110.005</b>	SCREW AUT.TCB 3,9X9,5 DIN 7981F VITE AUT.TCB 3,9X9,5 DIN 798
	33		<b>9111.446.050</b>	FUNNEL FOR MIXER TRAY IMBUTO X VASCHETTA MIXER
	34		<b>0862.111.050</b>	GROUND S DUCT CONDOTTO X FONDI
	35		<b>0862.112</b>	GROUND SACK RING 8P КОЛЬЦО ANELLO SACCO FONDI 8P
	36	 ПІД ЗАМОВЛЕННЯ	<b>11001581</b>	EXTENSION TANK COFFEE EXTENSION TANK COFFEE

## Model Machine

MACSAE159

ATLANTE 700 EVO





























	37		9111.724	CONTAINER FOR COFFEE BEAN <i>CONTENITORE CAFFE' IN GRANI</i>
	38		11010736	ASS.GUILLOTINE COFFEE (1813.027) <i>ASS.GUILLOTINE COFFEE</i>
	39		9111.728	COVER FOR COFFEE CONTAINER <i>COPERCHIO CONTENITORE CAFFE'</i>
	40	 ПІД ЗАМОВЛЕННЯ	11008244	MODULE 3 MOTOR <i>MODULE 3 MOTOR</i>
	41	 ПІД ЗАМОВЛЕННЯ	U046.001	SCREW TEFZ M5,0X16 UNI 6921 GALV. <i>SCREW TEFZ M5,0X16 UNI 6921 GALV.</i>
	42	 ПІД ЗАМОВЛЕННЯ	NF11.115	BLIND RIVETS <i>BLIND RIVETS</i>
	43	 ПІД ЗАМОВЛЕННЯ	11008286	SUPPORT PANNEL UNIT <i>SUPPORT PANNEL UNIT</i>
	44	 ПІД ЗАМОВЛЕННЯ	11006485	COFFEE TANK ASSEMBLY WITH EXTENSION <i>ASS.CONTENITORE CAFFE CON PROLUNGA</i>
	44		9110.139	COFFEE CONT. ASS. <i>ASS.CONTENITORE CAFFE'</i>
	45	 УВАЖИТЬ	11008259	MODULE 2 MOTOR <i>MODULE 2 MOTOR</i>
	46		9111.481.060	COLUMN CAP <i>COLUMN CAP</i>
	47		U116.003	SCREW AUT.PT TCB 3,0X12 WN 1441 <i>VITE AUT.PT TCB 3,0X12 WN 1441 ZNP</i>
	48		11025813	BOILER CASE ATLANTE650 BROWN <i>BOILER CASE ATLANTE650 BROWN</i>
	49		11025812	CASE OF CONDENSE ATL650 BROWN <i>CASE OF CONDENSE ATL650 BROWN</i>



## Model Machine

MACSAE159























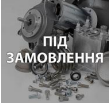

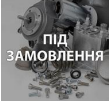
ATLANTE 700 EVO

	50		11008270	CASE OF CONDENSE CASE OF CONDENSE
	51		11008262	GRIND SUPPORT SUPPORTO MACININO GRIND SUPPORT
	52		11008248	COFFEE MODULE 1 GRIND COFFEE MODULE 1 GRIND
	53		11009912	CONNECTOR SUPPORT SG650 CONNECTOR SUPPORT SG650
	54		11008246	ASPIRATION STEEL SHEET AT 3 ASPIRATION STEEL SHEET AT 3
	55		11008245	ASPIRATION STEEL SHEET AT 3 ASPIRATION STEEL SHEET AT 3
	56		11026013	MIXER TRAY BROWN SG650 MIXER TRAY BROWN SG650
	57		11008186	ARM SUPPORT ASS. ARM SUPPORT ASS.
	57		11031749	ARM SUPPORT ARM SUPPORT
	58		11008249	МОДУЛЬ ПОДВІЙНОЇ КАВОМОЛКИ COFFEE MODULE 2 GRIND
	59		U110.002	SCREW AUT.TCB 3,5X13 DIN 7981F SCREW AUT.TCB 3,5X13 DIN 7981 F
	60		9161.305.150	ЗАГЛУШКА РЕЗИНОВА GREY 8GR.BREW UNIT INTEGRAL PISTON PLUG
	61		U043.031	SCREW TCBC M5,0X40 UNI 7687 GALV. SCREW TCBC M5,0X40 UNI 7687 GALV.
	62		NE05.002	МІКРОВИМИКАЧ ДЛЯ КАВОМАШИНИ EF83161.8 MICROINTERRUTTORE

## Model Machine

MACSAE159























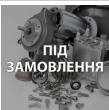

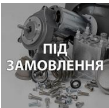

ATLANTE 700 EVO

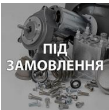
	63		11025284	MOTORIDUTTORE FIBER 37RPM <i>MOTORIDUTTORE FIBER 37RPM</i>
	63		9121.107.00P	STIRRER RATIONOTOR FIBER <i>MOTORIDUTTORE PALETTE FIBER</i>
	64		U110.012	SCREW TC WN1412 /BN13577 ZINCBIA KA 3X2 <i>SCREW TC WN1412 /BN13577 ZINC BIA KA 3X2</i>
	65		11008188	CAM ARM <i>CAM ARM</i>
	65		11031823	CAM ARM <i>CAM ARM</i>
	66		11008241	CONNECTING ROD ARM <i>CONNECTING ROD ARM</i>
	66		11031893	CONNECTING ROD ARM <i>CONNECTING ROD ARM</i>
	67		11008240	SUPPORT ARM PLATE <i>SUPPORT ARM PLATE</i>
	68		9111.204	BUSH FOR SPRING COMPENSATE STIRRER <i>BOCCOLA X MOLLA BILANCERE PALETTE</i>
	69		U116.002	SCREW AUT.PT TCB 3,5X16 WN 1441 <i>SCREW AUT.PT TCB 3,5X16 WN 1441</i>
	70		11032060	TUBE CONVEYOR COFFEE DOUBLE GRIND <i>TUBE CONVEYOR COFFEE DOUBLE GRIND</i>
	71		11008187	NOZZLE ARM <i>BRACCIO GIREVOLE NOZZLE ARM</i>
	72		11008242	SUPPORT ARM PLATE <i>SUPPORT ARM PLATE</i>

## Model Machine

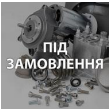
MACSAE159

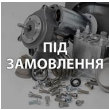
ATLANTE 700 EVO

	73		11008189	SUPPORT ARM <i>SUPPORTO BRACCIO SUPPORT ARM</i>
	74		11008268	UPPER PIN OF ROTATION <i>UPPER PIN OF ROTATION</i>
	75		U324.005	NUT M3 FLANGED INDENTED BASE <i>DADO M3 FLANGIATO BASE DENTELLATA</i>
	76		NE05.018	MICROSWITCH <i>MICROINTERRUTTORE SAECO XCG5-81-P5</i>
	77		11001574	FLANGE FIXING RATION MOTOR LIP <i>FLANGIA FISSAGGIO MOTORIDUTTORI LIP</i>
	78		129824002	TCB SCREW M4X10 UNI 7687 ZNP <i>VITE TCB M4X10 UNI 7687 ZNP</i>
	79		11031340	BUSH <i>BUSH</i>
	80		U201.001	PLAIN WASHER 3,2X9 DIN 7349 GALV. <i>PLAIN WASHER 3,2X9 DIN 7349 GALV.</i>
	81		U110.011	SCREW AUT.TCB 2,9X9,5 DIN 7981F <i>SCREW AUT.TCB 2,9X9,5 DIN 7981 F</i>
	82		12001124	RELAY FINDER 056.26 <i>RELAY FINDER 056.26</i>
	83		11002131	CARTER FOR MIXER TANK <i>CARTER X VASCA MIXER</i>
	84		11031748	CARTEGHO NOZZLES SUPPORT <i>CARTEGHO NOZZLES SUPPORT</i>
	85		1484.605	POWER RELAY 12A <i>POWER RELAY 12A</i>
	86		140321762	O-RING 3218 SILICONE <i>O-RING 3218 SILICONE</i>

## Model Machine

MACSAE159

ATLANTE 700 EVO



87

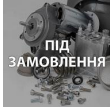

11032489

REINFORCEMENT ROTARY PLATE

*REINFORCEMENT ROTARY PLATE*

# Model Machine

MACSAE159

ATLANTE 700 EVO

MACSAE159.T.0003

TAVOLA NR. 3 - ARTICOLO ATLANTE 700 EVO

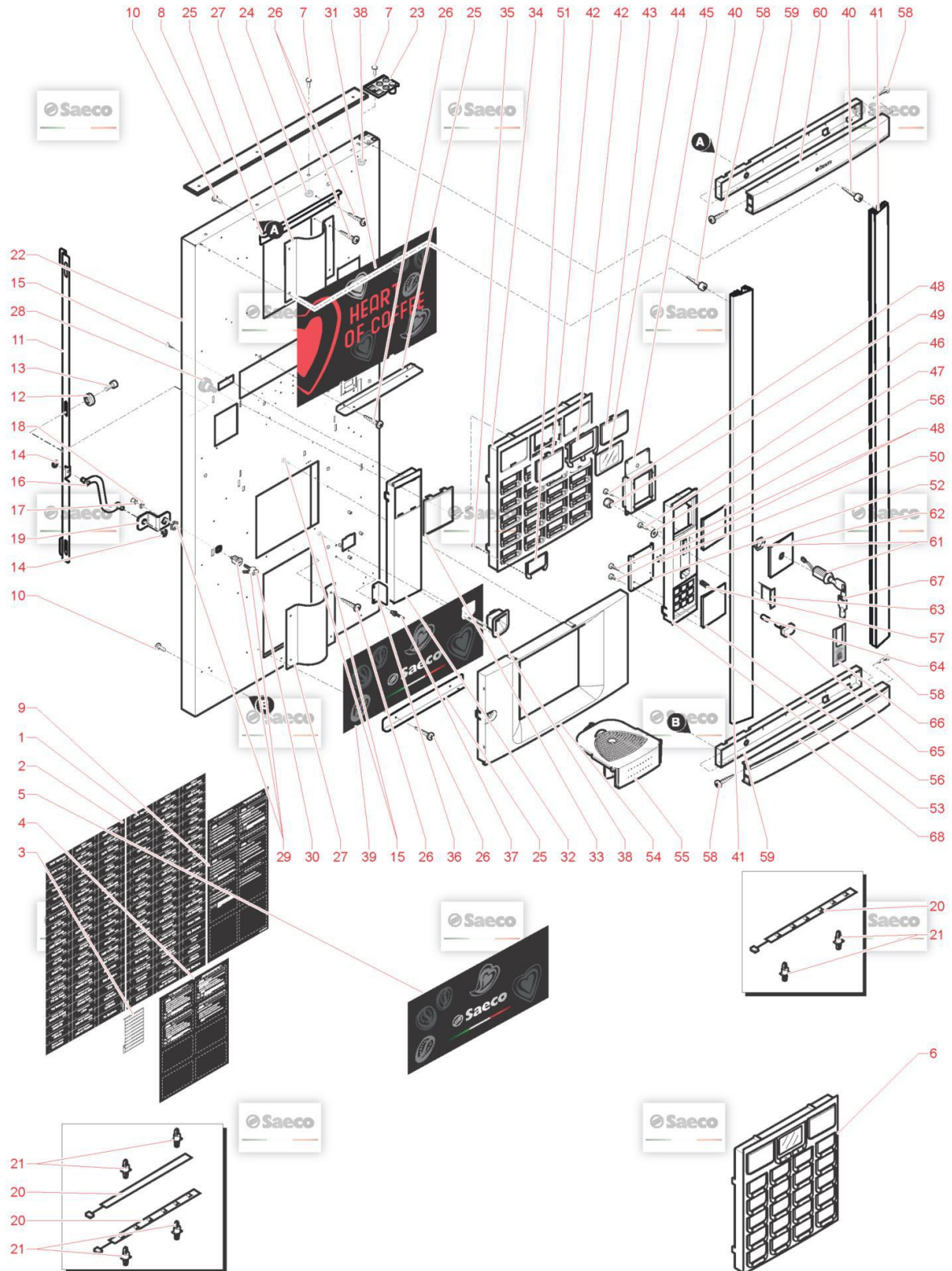

## Model Machine

MACSAE159

ATLANTE 700 EVO

Web Pos. Foto Item - Replace by Description



Press - CTRL + CLICK go to item in a new window  
Натисніть - Ctrl + права кнопка миші щоб відкрити запчастину в новому вікні



1

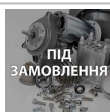

15001691

PRODUCTS LABEL'S SHEET RX ATLANTE ITA  
*PRODUCTS LABEL'S SHEET RX ATLANTE ITA*



1

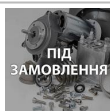

15001693

PRODUCTS LABEL'S SHEET RX ATLANTE ENG  
*PRODUCTS LABEL'S SHEET RX ATLANTE ENG*



1

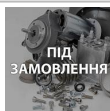

15001695

PRODUCTS LABEL'S SHEET RX ATLANTE FRA  
*PRODUCTS LABEL'S SHEET RX ATLANTE FRA*



1

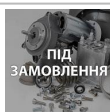

15001697

PRODUCTS LABEL'S SHEET RX ATLANTE DE  
*PRODUCTS LABEL'S SHEET RX ATLANTE DE*



1

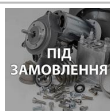

15001699

PRODUCTS LABEL'S SHEET RX ATLANTE SPA  
*PRODUCTS LABEL'S SHEET RX ATLANTE SPA*



1

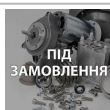

15001701

PRODUCTS LABEL'S SHEET RX ATLANTE POR  
*PRODUCTS LABEL'S SHEET RX ATLANTE POR*



1

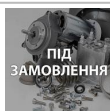

15001703

PRODUCTS LABEL'S SHEET RX ATLANTE NL  
*PRODUCTS LABEL'S SHEET RX ATLANTE NL*



1

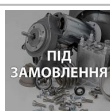

15004342

PRODUCTS LABEL'S SHEET RX ATLANTE CAPS  
*PRODUCTS LABEL'S SHEET RX ATLANTE CAPS*



2

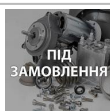

15001690

PRODUCTS LABEL'S SHEET LX ATLANTE ITA  
*PRODUCTS LABEL'S SHEET LX ATLANTE ITA*



2

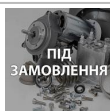

15001692

PRODUCTS LABEL'S SHEET LX ATLANTE ENG  
*PRODUCTS LABEL'S SHEET LX ATLANTE ENG*



2

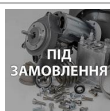

15001694

PRODUCTS LABEL'S SHEET LX ATLANTE FRA  
*PRODUCTS LABEL'S SHEET LX ATLANTE FRA*



2

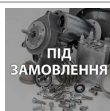

15001696

PRODUCTS LABEL'S SHEET LX ATLANTE DE  
*PRODUCTS LABEL'S SHEET LX ATLANTE DE*



2

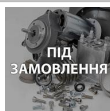











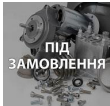

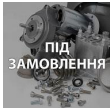

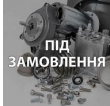

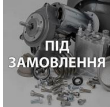





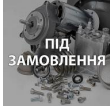

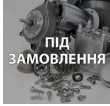

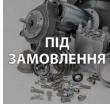
15001698

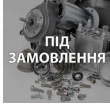
PRODUCTS LABEL'S SHEET LX ATLANTE SPA  
*PRODUCTS LABEL'S SHEET LX ATLANTE SPA*

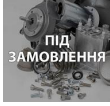
## Model Machine

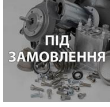
MACSAE159

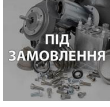





















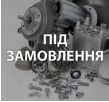

ATLANTE 700 EVO

	2		<b>15001700</b>	PRODUCTS LABEL'S SHEET LX ATLANTE POR <i>PRODUCTS LABEL'S SHEET LX ATLANTE POR</i>
	2		<b>15001702</b>	PRODUCTS LABEL'S SHEET LX ATLANTE NL <i>PRODUCTS LABEL'S SHEET LX ATLANTE NL</i>
	2		<b>15004341</b>	PRODUCTS LABEL'S SHEET LX ATLANTE CAPS <i>PRODUCTS LABEL'S SHEET LX ATLANTE CAPS</i>
	3		<b>0775.989</b>	PRICE LABELS WHITE EURO <i>PRICE LABELS WHITE EURO</i>
	4		<b>15001712</b>	INSTRUCTION LABEL'S SHEET ATLANTE ITA <i>INSTRUCTION LABEL'S SHEET ATLANTE ITA</i>
	4		<b>15001713</b>	INSTRUCTION LABEL'S SHEET ATLANTE ENG <i>INSTRUCTION LABEL'S SHEET ATLANTE ENG</i>
	4		<b>15001714</b>	INSTRUCTION LABEL'S SHEET ATLANTE FRA <i>INSTRUCTION LABEL'S SHEET ATLANTE FRA</i>
	4		<b>15001715</b>	INSTRUCTION LABEL'S SHEET ATLANTE DE <i>INSTRUCTION LABEL'S SHEET ATLANTE DE</i>
	4		<b>15001716</b>	INSTRUCTION LABEL'S SHEET ATLANTE SPA <i>INSTRUCTION LABEL'S SHEET ATLANTE SPA</i>
	4		<b>15001717</b>	INSTRUCTION LABEL'S SHEET ATLANTE POR <i>INSTRUCTION LABEL'S SHEET ATLANTE POR</i>
	4		<b>15001718</b>	INSTRUCTION LABEL'S SHEET ATLANTE NL <i>INSTRUCTION LABEL'S SHEET ATLANTE NL</i>
	5		<b>11032708</b>	LOWER ADVERTISING PLATE ATL700EVO <i>LOWER ADVERTISING PLATE ATL700EVO</i>
	6		<b>11032252</b>	ASS.PUSH BUTTON ATL700 RESTYLING <i>ASS.PUSH BUTTON ATL700 RESTYLING</i>
	7		<b>U047.008</b>	CAPSTAN SCREW WITH FRAME M6X20 <i>CAPSTAN SCREW WITH FRAME M6X20</i>

## Model Machine

MACSAE159

ATLANTE 700 EVO













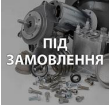





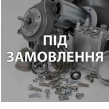



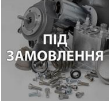

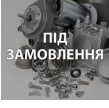

	8		<b>11031998</b>	THICK FRAME <i>SPESSORE CORNICE ATL700</i>
	9		<b>15002650</b>	INSTRUCTION LABEL'S SHEET ATL500 ITA <i>INSTRUCTION LABEL'S SHEET ATL500 ITA</i>
	9		<b>15002651</b>	INSTRUCTION LABEL'S SHEET ATL500 ENG <i>INSTRUCTION LABEL'S SHEET ATL500 ENG</i>
	9		<b>15002652</b>	INSTRUCTION LABEL'S SHEET ATL500 FRA <i>INSTRUCTION LABEL'S SHEET ATL500 FRA</i>
	9		<b>15002653</b>	INSTRUCTION LABEL'S SHEET ATL500 DE <i>INSTRUCTION LABEL'S SHEET ATL500 DE</i>
	9		<b>15002654</b>	INSTRUCTION LABEL'S SHEET ATL500 SPA <i>INSTRUCTION LABEL'S SHEET ATL500 SPA</i>
	9		<b>15002655</b>	INSTRUCTION LABEL'S SHEET ATL500 POR <i>INSTRUCTION LABEL'S SHEET ATL500 POR</i>
	9		<b>15002656</b>	INSTRUCTION LABEL'S SHEET ATL500 NL <i>INSTRUCTION LABEL'S SHEET ATL500 NL</i>
	10		<b>U127.011</b>	SCREW TAPT.TCB M5,0X8 DIN 7500C <i>SCREW TAPT.TCB M5,0X8 DIN 7500C</i>
	11		<b>11008662</b>	ROD FOR LOCK SG650 <i>ROD FOR LOCK SG650</i>
	12		<b>11008644</b>	LOCK PIN <i>LOCK PIN</i>
	13		<b>U046.001</b>	SCREW TEFZ M5,0X16 UNI 6921 GALV. <i>SCREW TEFZ M5,0X16 UNI 6921 GALV.</i>
	14		<b>U701.011</b>	STEEL SNAP RING 5 UNI 7434 <i>ANELLO ELASTICO 5 UNI 7434</i>



## Model Machine

MACSAE159

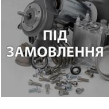



























ATLANTE 700 EVO

	15		<b>U116.006</b>	SCREW AUT.PT TCB 3,5X12 WN 1441 ZNP <i>VITE AUT.PT TCB 3,5X12 WN 1441 ZNP</i>
	16		<b>11008615</b>	LEVER ASS. LOCK <i>LEVER ASS. LOCK</i>
	17		<b>U302.004</b>	NUT HEXAGONAL M6 UNI 5588 <i>DADO ESAGONALE M6 UNI 5</i>
	18		<b>U208.006</b>	TOOTHED WASHER 6,4X11 UNI 3703 <i>ROSETTA DENT. 6,4X11 UNI 3</i>
	19		<b>11008640</b>	LEVER FOR LOCK <i>LEVER FOR LOCK</i>
	20		<b>11031810</b>	400MM LED BOARD <i>400 MM LED BOARD</i>
	21		<b>12002053</b>	SPACER FOR CARD LED MSPE-2-01 <i>SPACER FOR CARD LED MSPE-2-01</i>
	22		<b>11030930</b>	DOOR LED RIVET ATLANTE BLK <i>DOOR LED RIVET ATLANTE BLK</i>
	23		<b>11010205</b>	ADAPTER UPPER FRAME SILVER <i>ADAPTER UPPER FRAME SILVER</i>
	24		<b>U310.004</b>	NUT SELF LOCK.M6 UNI 7473 <i>NUT SELF LOCK.M6 UNI 7473</i>
	25		<b>11010210</b>	UPPER SUPPORT PLATE SG650 <i>UPPER SUPPORT PLATE SG650</i>
	26		<b>U110.004</b>	SCREW AUT.TCB 3,5X6,5 DIN 7981F <i>VITE AUT.TCB 3,5X6,5 DIN 7981 F NIK</i>
	27		<b>11030086</b>	REINFORCEMENT IMAGE ADVERTISING ATLANTE <i>REINFORCEMENT IMAGE ADVERTISING ATLANTE</i>
	28		<b>12002031</b>	KNOB D.18 M5X15 <i>KNOB D.18 M5X15</i>

## Model Machine

MACSAE159

















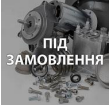





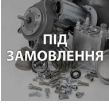

ATLANTE 700 EVO

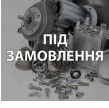
	29		NV02.229	LOCK RIELDA MOD.512 + KEY <i>LOCK RIELDA MOD.512 + KEY</i>
	30		NV02.243	KEY RIELDA AJ306A <i>KEY RIELDA AJ306A</i>
	31		11032706	UPPER ADVERTISING ATL700 EVO <i>UPPER ADVERTISING ATL700 EVO</i>
	31		11033208	UPPER ADVERTISING PLATE ATL700CAFFITALY <i>UPPER ADVERTISING PLATE ATL700CAFFITALY</i>
	32		11024252	LEFT SIDE PANEL SG650 <i>LEFT SIDE PANEL SG650</i>
	33		11023709	PUBLICITY FRONT PLATE ATLANTE500 <i>PUBLICITY FRONT PLATE ATLANTE500</i>
	34		11032082	PANNELLO TASTIERA ATLANTE <i>PANNELLO TASTIERA ATLANTE</i>
	35		129670302	TCB PANELVIT SCREW 2,9X9,5 TES.D=7,5 ZNP <i>TCB PANELVIT SCREW 2,9X9,5 TES.D=7,5 ZNP</i>
	36		11010203	UPPER SUPPORT PLATE SG650 <i>UPPER SUPPORT PLATE SG650</i>
	37		12000962	MULTIGRIP RIVETS 4.8X11 <i>MULTIGRIP RIVETS 4.8X11</i>
	38		11032329	FRONT PLATE GRY/SIL <i>FRONT PLATE GRY/SIL</i>
	39		11032707	LOWER ADVERTISING PLATE ATL700EVO <i>TARGA INFERIORE ATL700 EVO</i>
	39		11033209	LOWER ADVERTISING PLATE ATL700CAFFITALY <i>LOWER ADVERTISING PLATE ATL700CAFFITALY</i>
	40		U143.021	SCREW SPECIAL 4,8X9,5 SELF TAP. <i>SCREW SPECIAL 4,8X9,5 SELF TAP.</i>

## Model Machine

MACSAE159











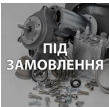













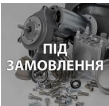

ATLANTE 700 EVO

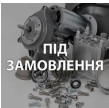
	41		<b>11031995</b>	AESTHETIC STRIP SIDE ATL700/ALISEO SIL <i>AESTHETIC STRIP SIDE ATL700/ALISEO SIL</i>
	42		<b>11032198</b>	DISPLAY FRONT PLATE <i>MOSTRINA DISPLAY NERO LUCIDO</i>
	43		<b>11008620</b>	PUBLICITY FRONT PLATE <i>MOSTRINA PUBBLICITARIA PUBLICITY FRONT PLATE</i>
	44		<b>11032397</b>	DISPLAY GLASS ATLANTE700 <i>DISPLAY GLASS ATLANTE700</i>
	45		<b>11023766</b>	SUPPORT COVER M125 OMEGA <i>SUPPORT COVER M125 OMEGA</i>
	46		<b>U109.005</b>	SCREW AUT.TCB 3,5X16 DIN 7981C <i>VITE AUT.TCB 3,5X16 DIN 798</i>
	47		<b>U201.001</b>	PLAIN WASHER 3,2X9 DIN 7349 GALV. <i>PLAIN WASHER 3,2X9 DIN 7349 GALV.</i>
	48		<b>U110.003</b>	SCREW AUT.TCB 3,5X9,5 DIN 7981F <i>VITE AUT.TCB 3,5X9,5 DIN 798</i>
	49		<b>U324.003</b>	NUT M5 FLANGED INDENTED BASE <i>NUT M5 FLANGED INDENTED BASE</i>
	50		<b>U701.003</b>	SNAP RING 7 UNI 7434 <i>ANELLO ELASTICO 7 UNI 7434</i>
	51		<b>11032199</b>	BUTTON FRONT PLATE <i>BUTTON FRONT PLATE</i>
	52		<b>11023763</b>	SHEET METAL COVER SLAVE ATLANTE650 <i>SHEET METAL COVER SLAVE ATLANTE650</i>
	53		<b>11032113</b>	ПРАВА ПАНЕЛЬ ATL700 <i>RIGHT SIDE PANEL ATL700</i>

## Model Machine

MACSAE159

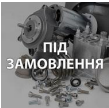
ATLANTE 700 EVO

	54	 ПІД ЗАМОВЛЕННЯ	11008598	DISPENSER FRAME VAIN BLK <i>DISPENSER FRAME VAIN</i>
	55		11001836	FS400 STANDARD GRILL <i>GRIGLIA STANDARD FS400</i>
	56		11023653	COVER SLAVE ATLANTE650 <i>COVER SLAVE ATLANTE650</i>
	57		9111.355	SPRING FOR CHANGE BUTTON <i>MOLLA X PULSANTE RENDIRESTO</i>
	58		U109.003	SCREW TCB 3,5X9,5 DIN 7981 C NICK <i>SCREW TCB 3,5X9,5 DIN 7981 C NICK</i>
	59		11031999	SUPPORT FRAME <i>SUPPORTO CORNICE ATL700/ALISEO</i>
	60		11032377	UPPER FRAME ATL700/ALISE <i>CORNICE SUPERIORE ATL700/ALISEO SERIG.</i>
	61		12001931	ЗАМОК 3355/11КА З ГАЙКОЮ <i>LOCK MERONI 3355/11KA+HARNESS</i>
	62	 ПІД ЗАМОВЛЕННЯ	11031790	COVER SLAVE ATL700 <i>COVER SLAVE ATL700</i>
	63	 ПІД ЗАМОВЛЕННЯ	11031374	CAP FOR INSERT COIN <i>TAPPO X INSERIMENTO MONETE</i>
	64	 ПІД ЗАМОВЛЕННЯ	11031375	BUSH BLOCK BUTTON CHANGE GIVER <i>BUSH BLOCK BUTTON CHANGE GIVER</i>
	65		11012634	PUSH BUTTON SG650 SILVER <i>PUSH BUTTON SG650 SILVER</i>
	65	 ПІД ЗАМОВЛЕННЯ	11031373	PUSH BUTTON SG650 <i>PULSANTE RENDIRESTO ATL700 BLK</i>
	66	 ПІД ЗАМОВЛЕННЯ	11032352	ADHESIVE COIN INTRODUCTION <i>ADHESIVE COIN INTRODUCTION</i>

## Model Machine

MACSAE159

ATLANTE 700 EVO



67

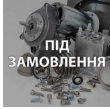

20007220

KEY MERONI 3H1833CTCC- KA0514520X

*KEY MERONI 3H1833CTCC- KA0514520X*



68



11031997

UPPER/LOWER FRAME

*UPPER/LOWER FRAME*

# Model Machine

MACSAE159

ATLANTE 700 EVO

MACSAE159.T.0004

TAVOLA NR. 4 - ARTICOLO ATLANTE 700 EVO

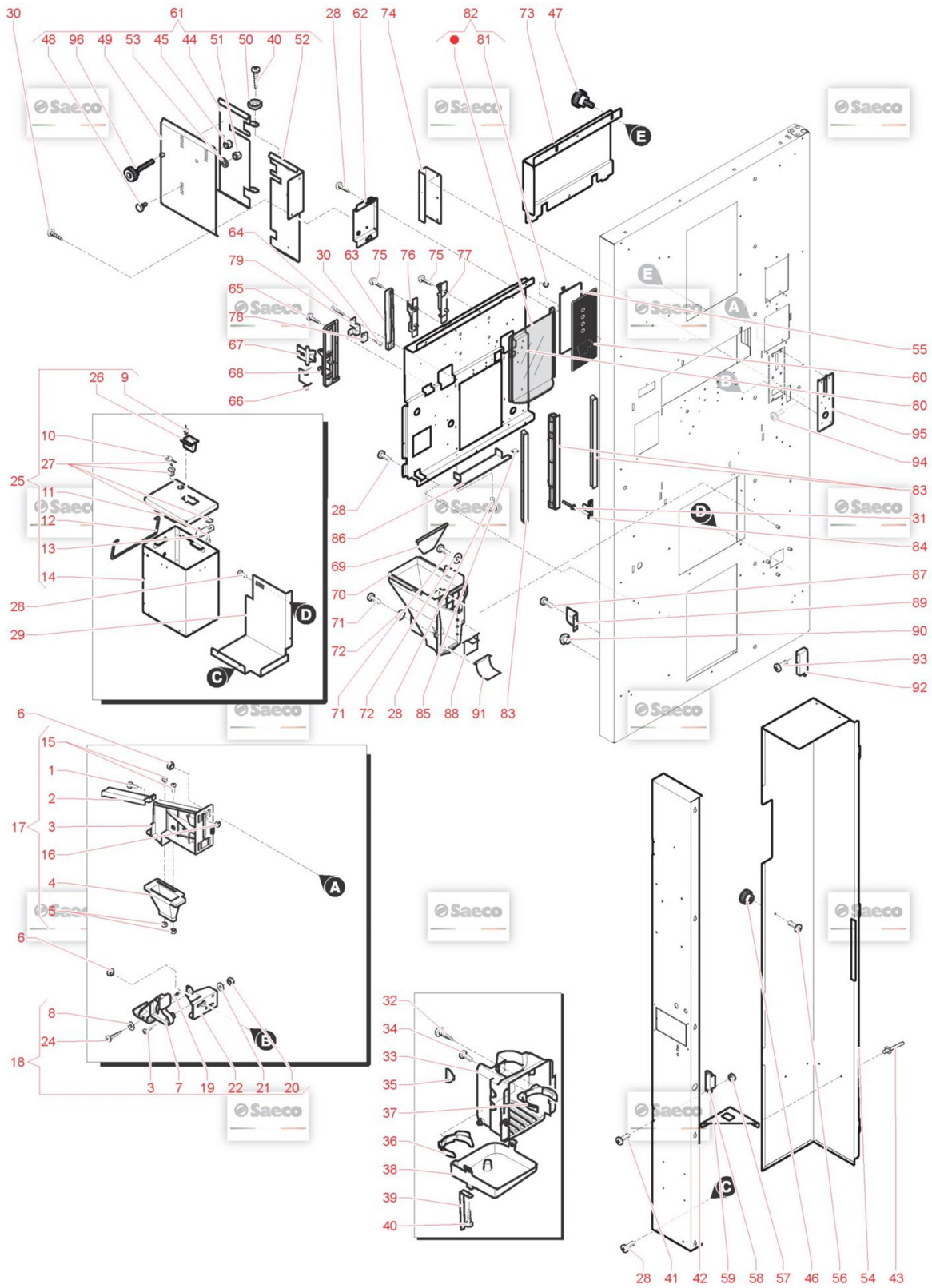

## Model Machine

MACSAE159

ATLANTE 700 EVO

Web Pos. Foto Item - Replace by Description



*Press - CTRL + CLICK go to item in a new window  
Натисніть - Ctrl + права кнопка миші щоб відкрити запчастину в новому вікні*



1



U043.007

SCREW TCBC M3,0X8 UNI 7687 GALV.  
SCREW TCBC M3,0X8 UNI 7687 GALV.



2



11011663

SLIDE COVER COIN  
SLIDE COVER COIN



3



11011616

COIN CHUTE  
COIN CHUTE



4



11011617

COIN CONVEYOR ADJUSTABLE  
COIN CONVEYOR ADJUSTABLE



5



U302.003

GALV.NUT HEXAGONAL M4 UNI 5589ZN  
DADO ESAGONALE M4 UNI 5588 ZNP



6

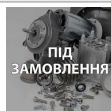

U324.003

NUT M5 FLANGED INDENTED BASE  
NUT M5 FLANGED INDENTED BASE



7



11011660

LEVER COIN RECOVERY  
LEVER COIN RECOVERY



8



U212.006

WASHER 3,2X11X0,5 ZNP  
WASHER 3,2X11X0,5 ZNP



9

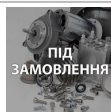

NF11.027

EXPANSION RIVET D.4X7,95 ALU.  
RIVETTO AD ESPANSIONE D.4X7,



10

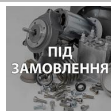

20007333

KEY MERONI 337  
KEY MERONI 337



11

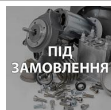

11009687

COVER COIN BOX  
COVER COIN BOX



12



9111.388

HANDLE FOR COIN CASE  
MANIGLIA X CASSA MONETE



13













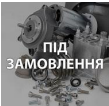















11031071

LEVER FOR LOCK  
LEVER FOR LOCK

## Model Machine

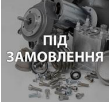
MACSAE159

ATLANTE 700 EVO



























	14		<b>11009683</b>	COIN CASE ASS. COIN CASE ASS.
	15		<b>12002039</b>	SCREW TCBD TORX 20 M4X12 ZN-B VITE TCBD TORX 20 M4X12 ZN-B
	16		<b>U302.002</b>	NUT HEXAGONAL M3 UNI 5588 NUT HEXAGONAL M3 UNI 5588
	17		<b>11011613</b>	COIN CHUTE ASS. ASS.SCIVOLO MONETE COIN CHUTE ASS.
	18		<b>11011615</b>	LEVER ASS. COIN RECOVERY LEVER ASS. COIN RECOVERY
	19		<b>9111.397</b>	SPRING FOR TRAY /LEVER COIN RECOVER MOLLA X BACINELLA/LEVA RECUP
	20		<b>123453102</b>	GALV.SELF LOCK NUT HIGH M4 DIN982 GALV.SELF LOCK NUT HIGH M4 DIN 982
	21		<b>U201.005</b>	PLAIN WASHER 4,3X12 DIN 7349 GAL PLAIN WASHER 4,3X12 DIN 7349 GAL
	22		<b>11011619</b>	SUPPORT LEVER COIN RECOVERY SUPPORT LEVER COIN RECOVERY
	23		<b>129825002</b>	TCB SCREW M4X20 UNI 7687 ZNP TCB SCREW M4X20 UNI 7687 ZNP
	24		<b>U116.005</b>	SCREW AUT.PT TCB 3,0X8 WN 1441 VITE AUT.PT TCB 3,0X8 WN 1441 ZNP
	25		<b>11012440</b>	COIN CASE ASS. COIN CASE ASS.
	26		<b>9111.174.050</b>	COIN HOPPER TRAMOGGIA MONETE
	27		<b>12001902</b>	LOCK MERONI 337 LOCK MERONI 337



## Model Machine

MACSAE159













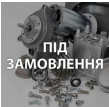

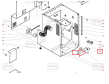









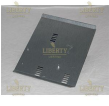

ATLANTE 700 EVO

	28		<b>U127.011</b>	SCREW TAPT.TCB M5,0X8 DIN 7500C <i>SCREW TAPT.TCB M5,0X8 DIN 7500C</i>
	29	 ПІД ЗАМОВЛЕННЯ	<b>11009688</b>	SUPPORT COIN BOX <i>SUPPORT COIN BOX</i>
	30	 ПІД ЗАМОВЛЕННЯ	<b>U110.011</b>	SCREW AUT.TCB 2,9X9,5 DIN 7981F <i>SCREW AUT.TCB 2,9X9,5 DIN 7981 F</i>
	31	 ПІД ЗАМОВЛЕННЯ	<b>12000962</b>	MULTIGRIP RIVETS 4.8X11 <i>MULTIGRIP RIVETS 4.8X11</i>
	32		<b>U109.022</b>	SCREW AUT.TCB 4,2X13 DIN 7981C <i>SCREW AUT.TCB 4,2X13 DIN 7981 C</i>
	33	 ПІД ЗАМОВЛЕННЯ	<b>1863.012.050</b>	COMPARTMENT DISPENSER <i>VANO EROGAZIONE</i>
	34		<b>U019.005</b>	STEI SCREW M5,0X10 UNI 5923 GALV. <i>VITE STEI M5,0X10 UNI 5923 Z</i>
	35		<b>1863.013</b>	LENS FOR COMPARTMENT DISPENSER <i>LENTE X VANO EROGAZIONE</i>
	36		<b>11027722</b>	CUP SUPPORT D.83 <i>CUP SUPPORT D.83</i>
	37		<b>9111.368.050</b>	VARIABLE CUP SUPPORT BLACK <i>SUPPORTO BICCHIERE VARIABILE</i>
	38		<b>1863.023.050</b>	WATER DRIP TRAY <i>VASCA X VANO EROGAZIONE</i>
	39		<b>1863.024</b>	STIRRUP FOR COMPARTMENT DISPENSER <i>STAFFA X VANO EROGATORE</i>
	40		<b>U110.005</b>	SCREW AUT.TCB 3,9X9,5 DIN 7981F <i>VITE AUT.TCB 3,9X9,5 DIN 798</i>

## Model Machine

MACSAE159

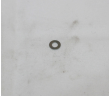









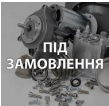















ATLANTE 700 EVO

	41		<b>U043.028</b>	SCREW TCBC M3,0X10 UNI 7687 GALV. SCREW TCBC M3,0X10 UNI 7687 GALV.
	42	 ПІД ЗАМОВЛЕННЯ	<b>11009121</b>	COVER SUPPORT SYSTEM PAYMENT COVER SUPPORT SYSTEM PAYMENT
	43		<b>NF11.015</b>	EXPANSION RIVET D=2,8X8 ALU. RIVETTO AD ESPANS. D=2,9X9 A
	44	 ПІД ЗАМОВЛЕННЯ	<b>0875.365</b>	SUP.COIN BOX SUP.COIN BOX
	45		<b>U302.001</b>	NUT HEXAGONAL M5 UNI 5588 DADO ESAGONALE M5 UNI 5
	46		<b>12002034</b>	KNOB WITH BUSH M5 KNOB WITH BUSH M5
	47	 ПІД ЗАМОВЛЕННЯ	<b>12002031</b>	KNOB D.18 M5X15 KNOB D.18 M5X15
	48		<b>9111.614</b>	COIN BOX ANCHORING PIN COIN BOX ANCHORING PIN
	49		<b>0875.357</b>	ASS.FIXING PLATE COIN BOX ASS.FIXING PLATE COIN BOX
	50		<b>1602.147</b>	BUSH FOR DOOR CONNECTING ROD BUSH FOR DOOR CONNECTING ROD
	51		<b>123160302</b>	NUT M3 HIGH UNI 5587 GALVANIZED NUT M3 HIGH UNI 5587 GALVANIZED
	52	 ПІД ЗАМОВЛЕННЯ	<b>11032971</b>	COIN BOX SUPPORT COIN BOX SUPPORT
	53		<b>U207.003</b>	PLAIN WASHER 3,2X7 UNI 6592 GALV. PLAIN WASHER 3,2X7 UNI 6592 GALV.
	54	 ПІД ЗАМОВЛЕННЯ	<b>11008928</b>	PAYMENT SYSTEMS COVER SG650 PAYMENT SYSTEMS COVER SG650

## Model Machine

MACSAE159















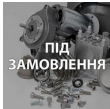

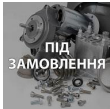

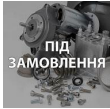

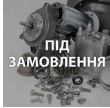

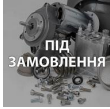

ATLANTE 700 EVO

	55		11025455	LED DIFFUSER FOR CUP <i>LED DIFFUSER FOR CUP</i>
	56		U043.015	SCREW TCBC M5,0X12 UNI 7687 GALV. <i>SCREW TCBC M5,0X12 UNI 7687 GALV.</i>
	57		U324.005	NUT M3 FLANGED INDENTED BASE <i>DADO M3 FLANGIATO BASE DENTELLATA</i>
	58		9991.182	MAGNET FOR DOOR SG700 <i>MAGNET FOR DOOR SG700</i>
	59		11012506	COVER RINFORCE FOR PAYMENT SYSTEMS <i>COVER RINFORCE FOR PAYMENT SYSTEMS</i>
	60		11008663	AESTHETIC PLATE SG650 <i>AESTHETIC PLATE SG650</i>
	61		11024638	ASS.SUPPORT COIN BOX <i>ASS.SUPPORT COIN BOX</i>
	62		11013496	FRONTAL PLATE SUPPORT COIN BOX <i>FRONTAL PLATE SUPPORT COIN BOX</i>
	63		1863.058	LEFT SUPPORT DISP.COMP. BLACK <i>SUPPORTO SX VANO EROGAZIONE</i>
	64		U109.003	SCREW TCB 3,5X9,5 DIN 7981 C NICK <i>SCREW TCB 3,5X9,5 DIN 7981 C NICK</i>
	65		U109.037	SCREW AUT.TCB 4,8X13 DIN 7981C <i>VITE AUT.TCB 4,8X13 DIN 7981 C NIK</i>
	66		9111.373	SPRING FOR DISP. COMP. RETAINING <i>MOLLA X FERMO VANO EROGAZ.</i>
	67		9111.372.050	DISP. COMPARTM. LOCKING LEVERBLACK <i>LEVA FERMO VANO EROGAZIONE NERO</i>
	68		9111.371.050	RIGHT SUPPORT DISP. COMP. BLACK <i>SUPPORTO DX VANO EROGAZ.NERO</i>

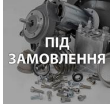
## Model Machine

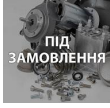
MACSAE159













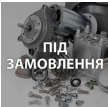







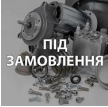





ATLANTE 700 EVO

	69		11011662	ADJUSTABLE PLATE <i>ADJUSTABLE PLATE</i>
	70		11011661	DUCT COIN RECOVERY <i>DUCT COIN RECOVERY</i>
	71		U046.001	SCREW TEFZ M5,0X16 UNI 6921 GALV. <i>SCREW TEFZ M5,0X16 UNI 6921 GALV.</i>
	72		U207.009	PLAIN WASHER 5,5X15 UNI 6593 GA <i>PLAIN WASHER 5,5X15 UNI 6593 GA</i>
	73		11013682	DISPLAY COVER AND POWER SUPPLYBLACK <i>DISPLAY COVER AND POWER SUPPLYBLACK</i>
	74		11013497	LEFT PLATE SUPPORT COIN BOX <i>LEFT PLATE SUPPORT COIN BOX</i>
	75		U110.002	SCREW AUT.TCB 3,5X13 DIN 7981F <i>SCREW AUT.TCB 3,5X13 DIN 7981 F</i>
	76		1863.032.A20	CUP DISTR. SUPPORT <i>SUPPORTO DISTRIBUTORE BICCH.SX</i>
	77		1863.033.A20	CUP DISTR. SUPPORT <i>SUPPORTO DISTRIBUTORE BICCH.DX</i>
	78		1863.649	REED FOR DOOR <i>REED FOR DOOR</i>
	79		11009693	SENSOR BRACKET VAIN SG650 <i>SENSOR BRACKET VAIN SG650</i>
	80		11010546	GLASSES SUPPORT BLACK SG650 <i>GLASSES SUPPORT BLACK SG650</i>
	81		9991.093	MAGNET D=9,5 X H=1,5 <i>MAGNETE D.9,5 X 1,5</i>

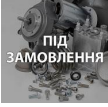
## Model Machine

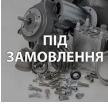
MACSAE159

ATLANTE 700 EVO

	82		11032646	CUP STATION'S DOOR <i>CUP STATION S DOOR</i>
	83		11008661	DOOR GUIDE VAIN <i>DOOR GUIDE VAIN</i>
	84		11008670	BRACKET FOR MICRO <i>BRACKET FOR MICRO</i>
	85		NV01.007	РЕЗИНОВА НАКЛЕЙКА 1 ШТ <i>PIEDINO ADESIVO</i>
	86		11009689	DRIPTRAY PARTITION <i>DRIPTRAY PARTITION</i>
	87		129720902	TE SCREW M5X10 UNI 5739 ZNP <i>TE SCREW M5X10 UNI 5739 ZNP</i>
	88		11006845	DOOR CONDUCTING COINS GREY <i>DOOR CONDUCTING COINS GREY</i>
	89		11012507	MOVABLE PLATE FOR ATLANTE DOOR <i>MOVABLE PLATE FOR ATLANTE DOOR</i>
	90		12001178	PROTECT 8,5X15X13 MOD. 30.21.001 <i>PROTECT 8,5X15X13 MOD. 30.21.001</i>
	91		9111.357.050	COIN CHUTE BOTTOM BLACK <i>FONDO CONDOTTO MONETE NERO</i>
	92		11008610	LOWER BLOCK HINGE ASS. <i>LOWER BLOCK HINGE ASS.</i>
	93		U046.006	SCREW TE M6,0X10 WITH WASHER <i>SCREW TE M6,0X10 WITH WASHER</i>
	94		U046.005	SCREW TE M5,0X10 WITH WASHER <i>SCREW TE M5,0X10 WITH WASHER</i>
	95		11012611	ASS.BLANK PROTECTION COIN CHANNEL ATLANT <i>ASS.BLANK PROTECTION COIN CHANNEL ATLANT</i>

## Model Machine

MACSAE159

ATLANTE 700 EVO



96

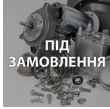

12002033

KNOB D.18 M5X25

*KNOB D.18 M5X25*

# Model Machine

MACSAE159

ATLANTE 700 EVO

MACSAE159.T.0005

TAVOLA NR. 5 - ARTICOLO ATLANTE 700 EVO

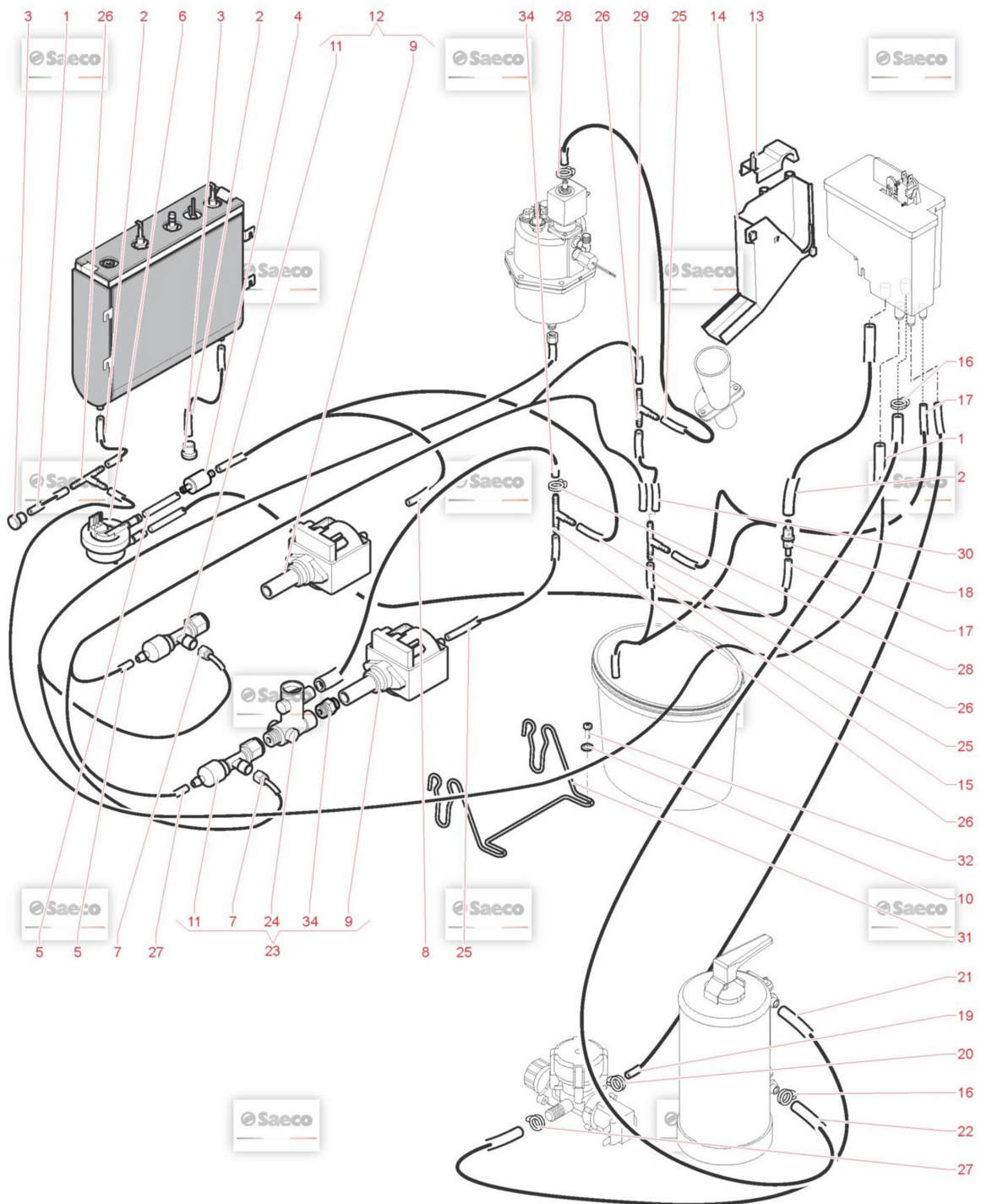

## Model Machine

MACSAE159

ATLANTE 700 EVO

Web Pos. Foto Item - Replace by Description



Press - CTRL + CLICK go to item in a new window

Натисніть - Ctrl + права кнопка миші щоб відкрити запчастину в новому вікні



1

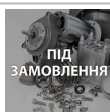

9972.313

SILICONE TUBE 7X11 L.170MM  
SILICONE TUBE 8X12 L.170 MM



2

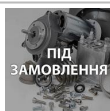

9972.310

SILICONE TUBE 7X11 L.70MM  
SILICONE TUBE 7X11 L.70 MM



3



NV03.006

CAP KAPSTO LPN 615/010  
TAPPO KAPSTO LPN 615/010



4

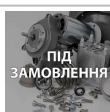

11024178

WATER FILTER PHEDRA  
WATER FILTER PHEDRA



5

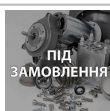

9972.189

SILICONE TUBE 5X10 L.345MM  
SILICONE TUBE 6X9 L.345 MM



6



NV99.099

TURBINE D=1,2 ASSY.  
TURBINA DIGMESA FHKSC 1,2 ARNITE OC



7



11025295

TEFLON TUBE 3X6 L.170 1/8"-1/8  
TEFLON TUBE 3X6 L.170 1/8-1/8



8

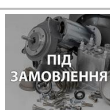

9972.257

SILICONE TUBE 5X10 L.100MM  
SILICONE TUBE 5X10 60SH L=110 MM



9

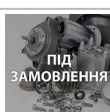

9070.034.00A

POMPE ULKA EP7  
POMPA ULKA EP7 230V



9



9070.042.00A

ULKA HACOC (ПОМПА) EX5GW 230/240V 50HZ SD1 БЪЯНКО 15 BAR  
ULKA PUMP EX5 SD1



10



U207.004

PLAIN WASHER 4,3X16 UNI 6592 GAL  
PLAIN WASHER 4,3X16 UNI 6592 GAL



11



11005590

SAFETY VALVE/NON RETURN ASS. NEW  
ASS.VALVOLA SICUREZZA/NON RI



12

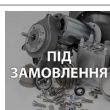

11030338



























ULKA EP7 T3X6 ATL700 TTT 230V  
ULKA EP7 T3X6 ATL700 TTT 230V

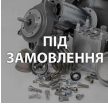

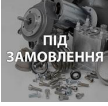
## Model Machine

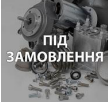
MACSAE159

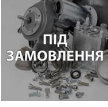

















ATLANTE 700 EVO

	13		9161.262.060	DRIP CHANNEL COVER <i>COPERTURA CANALINO RACCOGLIGOCCE</i>
	14		9111.528.050	COFFEE DISCHARGE CHANNEL <i>COFFEE DISCHARGE CHANNEL</i>
	15		9972.192	SILICONE TUBE 5X10 L.555MM <i>SILICONE TUBE 5X10 L.555MM</i>
	16		NV99.072	HOSE CLAMP D. 11.6/12.3 <i>HOSE CLAMP D. 11.6/12.3</i>
	17		11009789	SILICONE TUBE 5X10 L 1200MM <i>SILICONE TUBE 6X9 L 1200MM</i>
	17		11013436	SILICONE TUBE 5X10 L.650MM <i>SILICONE TUBE 5X10 L.650MM</i>
	18		144650300	ФІЛЬТР ОЧИСТКИ ВОДИ ДЛЯ КАВОМАШИНИ SAECO NEW (NV99.001) (88... <i>ASPIRATION FILTER GAUZE NET 500 (NEW)</i>
	19		11009788	SILICONE TUBE 5X10 L 1600MM <i>SILICONE TUBE 6X9 L 1600MM</i>
	20		184320200	SPRING HOSE CLAMP D=9,5MM <i>MOLLA STRINGITUBO D=9,5MM</i>
	21		9972.142	SILICONE TUBE 7X11 L. 400MM <i>SILICONE TUBE 8X12 L. 400 MM</i>
	22		11009787	SILICONE TUBE 7X11 L.1650MM <i>SILICONE TUBE 8X12 L 1650MM</i>
	23		11032212	ULKA EX5 SD1 220/60 <i>ULKA EX5 SD1 220/60</i>
	23		11032616	ULKA EX5 SD1 ATL700 CAPS <i>ULKA EX5 SD1 ATL700 CAPS</i>
	24		20007360	ОБХІДНИЙ КЛАПАН FLUID-O-TECH B7E <i>BYPASS VALVE FLUID-O-TECH B7E</i>

## Model Machine

MACSAE159

ATLANTE 700 EVO

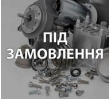
	25		9972.247	SILICONE TUBE 5X10 L.1400MM <i>TUBO SILICON.5X10 L=2000MM 60 SHORE</i>
	26		NV99.004	CONNECTOR T MORONI 8026047 D=8 <i>CONNECTOR T MORONI 8026047 D=8</i>
	27		NV99.050	HOSECLAMP D. 13.3/14.1 <i>HOSECLAMP D. 13.3/14.1</i>
	28	 ПІД ЗАМОВЛЕННЯ	NV99.087	BAND D=11/11,6 <i>BAND D=11/11,6</i>
	29	 ПІД ЗАМОВЛЕННЯ	9972.202	SILICONE TUBE 5X10 L.320MM <i>SILICONE TUBE 5X10 L.320MM</i>
	30	 ПІД ЗАМОВЛЕННЯ	9972.208	SILICONE TUBE 5X10 L.55MM <i>SILICONE TUBE 5X10 L.55MM</i>
	31		9111.343	SPRING FOR MOTOR PUMP FIXING <i>MOLLA X BLOCCAGGIO ELETTROPO</i>
	32		12002052	ZN-B TCB SCREW M4X16 <i>ZN-B TCB SCREW M4X16</i>
	33		11032615	FITTING ADAPTER VALVE <i>FITTING ADAPTER VALVE</i>
	34	 ПІД ЗАМОВЛЕННЯ	11031413	SILICONE TUBE 7X11 L.240MM <i>SILICONE TUBE 7X11 L.240MM</i>

# Model Machine

MACSAE159

ATLANTE 700 EVO

MACSAE159.T.0006



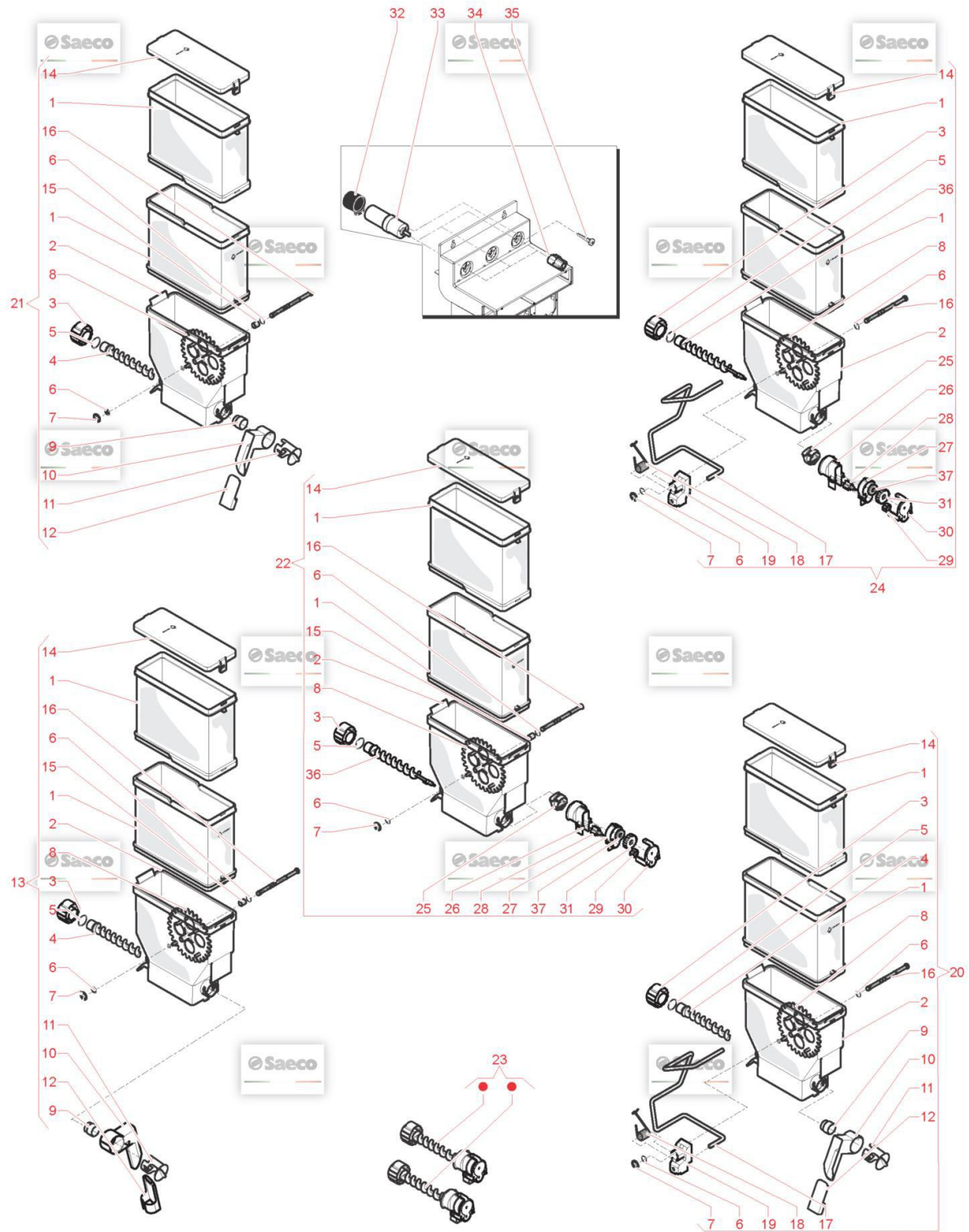























TAVOLA NR. 6 - ARTICOLO ATLANTE 700 EVO



## Model Machine

MACSAE159













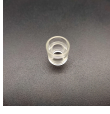











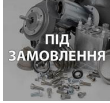

ATLANTE 700 EVO

Web	Pos.	Foto	Item - Replace by	Description
				<i>Press - CTRL + CLICK go to item in a new window Натисніть - Ctrl + права кнопка миші щоб відкрити запчастину в новому вікні</i>
	1		11001577	EXTENSION CONTAINER SINGLE SOLUBLE <i>PROLUNGA CONTENITORE SOLUBILE SINGOLO</i>
	2		11001576	BASE CONTAINER SINGLE SOLUBLE <i>BASE CONTENITORE SOLUBILE SINGOLO</i>
	3		11012130	BACK BUSH REINFORCE <i>BACK BUSH REINFORCE</i>
	4		11001658	SCROLL SCREW <i>COCLEA PER DEVIATORE</i>
	5		NM03.013	OR 2,3X15 NBR <i>OR 2,3X15 NBR</i>
	6		NM03.022	OR ORM 0060-10 NBR <i>OR ORM 0060-10 NBR</i>
	7		U701.003	SNAP RING 7 UNI 7434 <i>ANELLO ELASTICO 7 UNI 7434</i>
	8		9111.702	WHEEL DOUBLE CONTAINER <i>RUOTA CONTENITORE DOPPIO</i>
	9		11001654	BUSH CONTAINER <i>BOCCOLA CONTENITORE</i>
	10		9111.425.060	POWDER DUCT <i>CONDOTTO POLVERE ORIENTABILE</i>
	11		9111.457.060	BUSH FOR LEFT/RIGHT DUCT COSMEC <i>BOCCOLA X CONDOTTO DX-SX COSMEC</i>
	12		9111.428.060	PLUG FOR LEFT-RIGHT DUCT <i>TAPPO X CONDOTTO DX-SX</i>
	13		11010751	ASSEMBLY SINGLE CONTAINER W/SWITCH <i>ASSEMBLY SINGLE CONTAINER W/SWITCH</i>

## Model Machine

MACSAE159

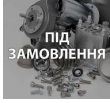



















ATLANTE 700 EVO

	14		11001578	COVER CONTAINER SINGLE SOLUBLE <i>COPERCHIO CONTENITORE SOLUBILE SINGOLO</i>
	15		11032945	SPACE FOR GEAR BPA FREE <i>SPACE FOR GEAR BPA FREE</i>
	16		11001580	PIN WHEEL CONTAINER SINGLE SOLUBLE <i>PERNO RUOTA DENTATA CONT.SOLUB.SINGOLO</i>
	17		11006124	WIRE AGITATOR UNIFIED <i>FILO AGITATORE UNIFICATO WIRE AGITATOR UNIFIED</i>
	18		9111.731	SPRING <i>MOLLA AGITATORE</i>
	19		11007155	ПЛАСТИКОВИЙ ТРИМАЧ ВЗБИВАЛКИ SAECO 9111.735 <i>AGITATOR SUPPORT</i>
	20		11006373	ASS.SINGLE CONTAINER W/AGITATOR SWITCH <i>ASS.SINGLE CONTAINER W/AGITATOR SWITCH</i>
	21		11004505	ASSEMBLY SINGLE CONTAINER W/SWITCH <i>ASS.MONTATO CONT.SINGOLO C/DEVIATORE</i>
	22		11031883	ASSEMBLY SINGLE CONTAINER <i>ASSEMBLY SINGL CONTAINER</i>
	23		21001290	KIT NEW POWDER DISPENSING SYSTEM <i>KIT NEW POWDER DISPENSING SYSTEM</i>
	24		11031886	ASSEMBLY SINGLE CONTAINER <i>ASSEMBLY SINGLE CONTAINER</i>
	25		11028378	FRONT BUSH <i>FRONT BUSH</i>
	26		11031678	EASY DRY DISPENSER APERTURE <i>EASY DRY DISPENSER APERTURE</i>
	27		11031691	CARTER FOR GEAR EASY DRY <i>CARTER FOR GEAR EASY DRY</i>

## Model Machine

MACSAE159

ATLANTE 700 EVO

	28		11031679	DISPENSER FAN EASY DRY <i>DISPENSER FAN EASY DRY</i>
	29		11005182	WHEEL Z=9 <i>WHEEL Z=9</i>
	30		11005168	LID CARTER GEAR <i>LID CARTER GEAR</i>
	31		11031690	WHEEL Z=18 EASY DRY <i>WHEEL Z=18 EASY DRY</i>
	32		9121.155	HOOD FOR RATIOMOTOR <i>CUFFIA X MOTORIDUTTORE</i>
	33		9121.106.00P	SUGAR RATIOMOTOR 24V DC <i>MOTORIDUTTORE ZUCCHERO 24V D.C.</i>
	34		9111.131	COUPLING FOR SOLUBLES MOTOR <i>GIUNTO X MOTORE SOLUBILI</i>
	35		U116.005	SCREW AUT.PT TCB 3,0X8 WN 1441 <i>VITE AUT.PT TCB 3,0X8 WN 1441 ZNP</i>
	36		11005180	SCROLL SCREW FOR NEW DISPENSER APERTURE <i>COCLEA X BOCCHETTA EROGAZIONE APERTURE SCROLL SCREW FOR ...</i>
	37		11031692	FELT RING DE=47,4 DI=41,4H=4 <i>FELT RING DE=47,4 DI=41,4H=4</i>

# Model Machine

MACSAE159

ATLANTE 700 EVO

MACSAE159.T.0007



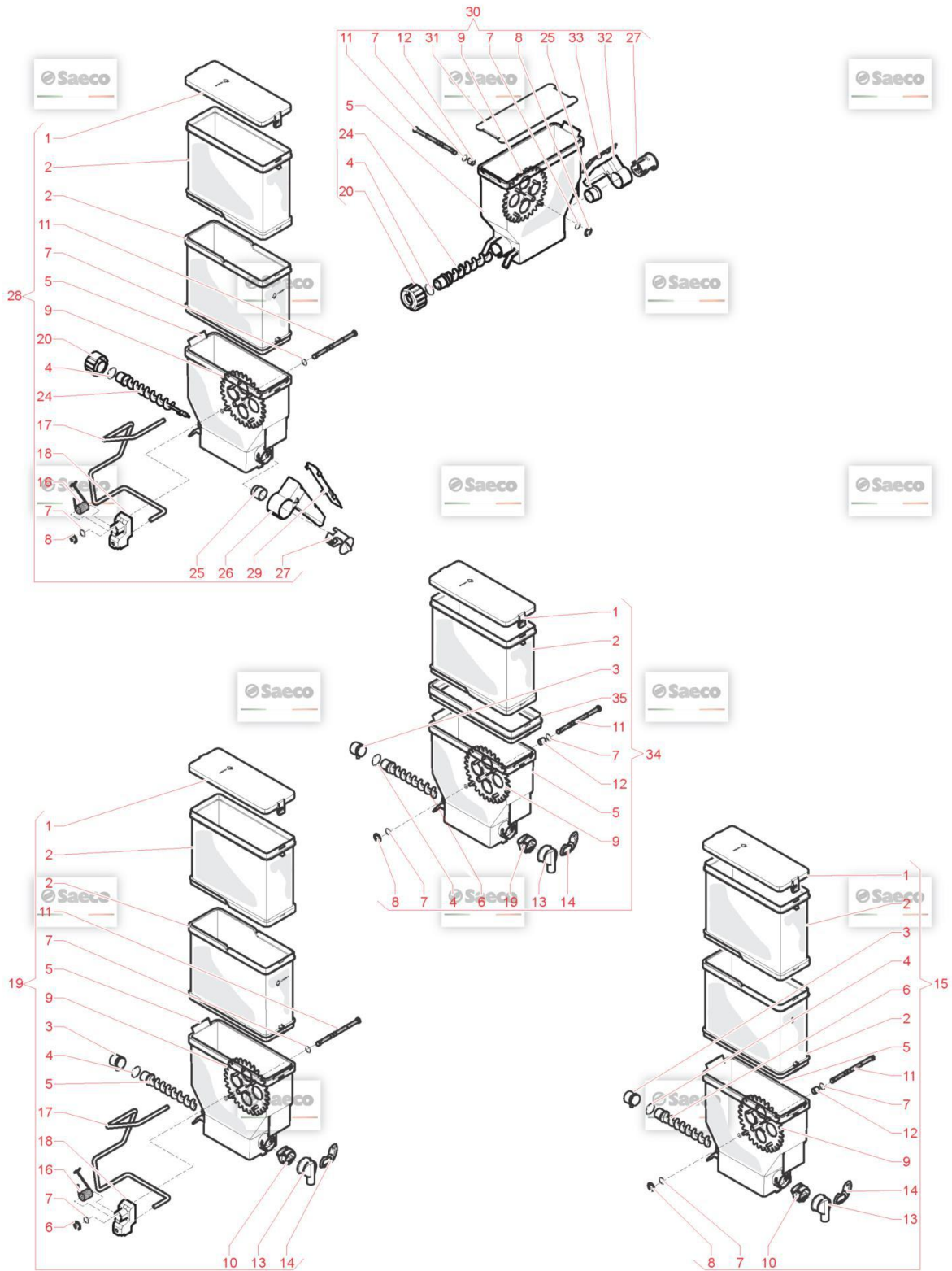























TAVOLA NR. 7 - ARTICOLO ATLANTE 700 EVO



## Model Machine

MACSAE159

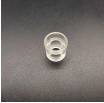
ATLANTE 700 EVO





















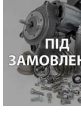





Web	Pos.	Foto	Item - Replace by	Description
				<i>Press - CTRL + CLICK go to item in a new window Натисніть - Ctrl + права кнопка миші щоб відкрити запчастину в новому вікні</i>
	1		11001578	COVER CONTAINER SINGLE SOLUBLE COPERCHIO CONTENITORE SOLUBILE SINGOLO
	2		11001577	EXTENSION CONTAINER SINGLE SOLUBLE PROLUNGA CONTENITORE SOLUBILE SINGOLO
	3		11005457	REAR BUSH NEW BOCCOLA POSTERIORE UN SOLO AGGANCIAMENTO NEW
	4		NM03.013	OR 2,3X15 NBR OR 2,3X15 NBR
	5		11001576	BASE CONTAINER SINGLE SOLUBLE BASE CONTENITORE SOLUBILE SINGOLO
	6		9111.701	SCROLL SCREW DOUBLE CONTAINER COCLEA CONTENITORE DOPPIO
	7		NM03.022	OR ORM 0060-10 NBR OR ORM 0060-10 NBR
	8		U701.003	SNAP RING 7 UNI 7434 ANELLO ELASTICO 7 UNI 7434
	9		9111.702	WHEEL DOUBLE CONTAINER RUOTA CONTENITORE DOPPIO
	10		9111.630.060	BUSH FOR POWDERS TANK BOCCOLA X SERBAT.POLVERI C/AGGANCI
	11		11001580	PIN WHEEL CONTAINER SINGLE SOLUBLE PERNO RUOTA DENTATA CONT.SOLUB.SINGOLO
	12		11032945	SPACE FOR GEAR BPA FREE SPACE FOR GEAR BPA FREE
	13		9111.629.060	APERTURE FOR SOLUBLES HOPPER APERTURE FOR SOLUBLES HOPPER

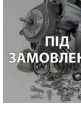

## Model Machine

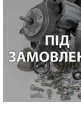
MACSAE159

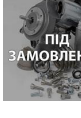
ATLANTE 700 EVO

	14		9111.338.270	BULKHEAD FOR APERT. CLOSURE ORANGE <i>PARATIA CHIUSURA BOCCHETTA ARANCIO</i>
	15		11026696	ASSEMBLY SINGLE CONTAINER <i>ASS.MONT.CONTENITORE SINGOLO</i>
	16		9111.731	SPRING <i>MOLLA AGITATORE</i>
	17		11006124	WIRE AGITATOR UNIFIED <i>FILO AGITATORE UNIFICATO WIRE AGITATOR UNIFIED</i>
	18		11007155	ПЛАСТИКОВИЙ ТРИМАЧ ВЗБИВАЛКИ SAECO 9111.735 <i>AGITATOR SUPPORT</i>
	19	 ПІД ЗАМОВЛЕННЯ	11031640	ASSEMBLY SINGLE CONTAINER WITHAGITATOR <i>ASSEMBLY SINGLE CONTAINER WITH AGITATOR</i>
	20		11012130	BACK BUSH REINFORCE <i>BACK BUSH REINFORCE</i>
	21		11001658	SCROLL SCREW <i>COCLEA PER DEVIATORE</i>
	22		11001654	BUSH CONTAINER <i>BOCCOLA CONTENITORE</i>
	23	 ПІД ЗАМОВЛЕННЯ	11029131	SWITCH COFFEE FOR ATL700 TTT ETL <i>SWITCH COFFEE FOR ATL700 TTT ETL</i>
	24		9111.457.060	BUSH FOR LEFT/RIGHT DUCT COSMEC <i>BOCCOLA X CONDOTTO DX-SX COSMEC</i>
	25	 ПІД ЗАМОВЛЕННЯ	11029126	ASS.SINGLE CONTAINER W/AGITATOR SWITCH <i>ASS.MONT.CONT.SING.C/AGITAT.ATL700 TTT</i>
	26	 ПІД ЗАМОВЛЕННЯ	11029495	SWITCH COVER COFFEE 'X ATL700TTT ETL <i>SWITCH COVER COFFEE 'X ATL700TTT ETL</i>
	27	 ПІД ЗАМОВЛЕННЯ	11031850	ASSEMBLY SOLUBLES CONTAINER SIDE <i>ASSEMBLY SOLUBLES CONTAINER SIDE</i>

## Model Machine

MACSAE159

ATLANTE 700 EVO



28

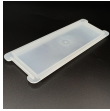

11007974

COVER CONTAINER SOLUBLE  
*COVER CONTAINER SOLUBLE*



29

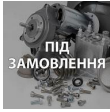

11013385

SWITCH FOR PHEDRA TTT  
*SWITCH FOR PHEDRA TTT*



30

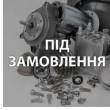

11013386

COVER FOR SWITCH PHEDRA TTT  
*COPERCHIO X DEVIATORE PHEDRA TTT*



31

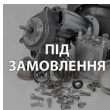

11032542

ASSEMBLY SINGLE CONTAINER H.350  
*ASS.CONT.SINGOLO SOLUBILE H.350*



32

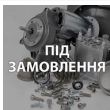

11032119

ADAPTER FOR EXTENSION CONTAINER SOLUBLE  
*ADAPTER FOR EXTENSION CONTAINER SOLUBLE*

# Model Machine

MACSAE159

ATLANTE 700 EVO

MACSAE159.T.0008

TAVOLA NR. 8 - ARTICOLO ATLANTE 700 EVO

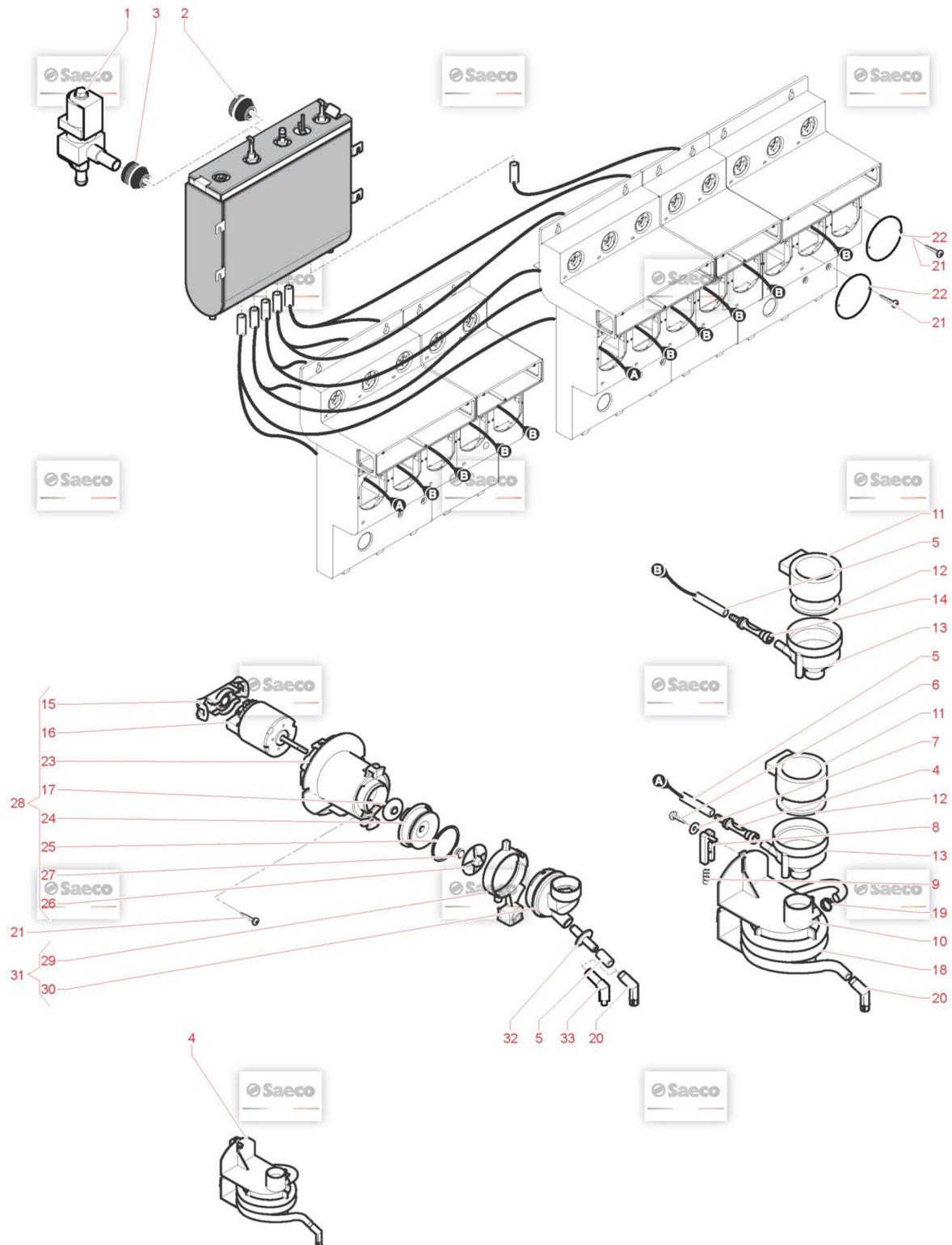

## Model Machine

MACSAE159

ATLANTE 700 EVO

Web Pos. Foto Item - Replace by Description



Press - CTRL + CLICK go to item in a new window  
Натисніть - Ctrl + права кнопка миші щоб відкрити запчастину в новому вікні



1



11032608

SOLUBLE ELECTROVALVE 24VDC ODE  
SOLUBLE ELECTROVALVE 24VDC ODE



2



9011.195

PLUG FOR BOILER  
PLUG FOR BOILER



3



9111.507

СИЛІКОНОВА РЕЗИНКА БОЙЛЕРА ДЛЯ РОЗЧИННИХ РЕЧОВИН  
PASSATUBO X ELETTROV. CALDAIA



4



1863.A10

ASS.MIXER FS400  
ASS.MIXER A SPIRALE FS400



5



9972.057

SILICONE TUBE 5X8 L.2000MM  
TUBO SILICONE MARRON 5X8 L.2000 MM



6



U116.005

SCREW AUT.PT TCB 3,0X8 WN 1441  
VITE AUT.PT TCB 3,0X8 WN 1441 ZNP



7



U207.004

PLAIN WASHER 4,3X16 UNI 6592 GAL  
PLAIN WASHER 4,3X16 UNI 6592 GAL



8



9111.209.060

CURSOR FOR SPIRAL MIXER FIXING  
CURSOR FOR SPIRAL MIXER FIXING



9



9111.211

SPRING FOR MIXER CURSOR  
MOLLA X CURSORE MISCELATORE



10



9111.643.060

RAPID FIXING MIXER  
RAPID FIXING MIXER



11



9111.010.060

LID FOR FUNNEL BROWN  
COPERCHIO X IMBUTO MARRON



12



9111.011.060

SEAL FOR FUNNEL BROWN  
GUARNIZIONE X IMBUTO MARRON



13































9111.009.060

FUNNEL FOR POWDERS BROWN  
IMBUTO X POLVERI MARRON

## Model Machine

MACSAE159













ATLANTE 700 EVO

	14		11011394	NOZZLE ASS. ESPRESSO D.3 <i>NOZZLE ASS. ESPRESSO D.3</i>
	15		9111.771.270	MOTOR COUPLING ORANGE RAL <i>MOTOR COUPLING ORANGE RAL</i>
	16		9121.248.00P	MOTOP MIKCEPA '05 24V DC - M.B.T. COD. 912124800 SAECO 9121.248.00 <i>MOTORE MIXER '05 24V DC - M.B.T.</i>
	17		9111.773.060	MOTOR PROTECTION RING <i>ANELLO PROTEZIONE MOTORE MIXER '05</i>
	18		9972.055	SILICONE TUBE 7X11 L.2000MM <i>SILICONE TUBE 8X12 L.2000MM</i>
	19		NV99.072	HOSE CLAMP D. 11.6/12.3 <i>HOSE CLAMP D. 11.6/12.3</i>
	20		9111.349	ELBOW DISPENSING NOZZLE <i>UGELLO EROGAZIONE GOMITO</i>
	21		U116.006	SCREW AUT.PT TCB 3,5X12 WN 1441 ZNP <i>VITE AUT.PT TCB 3,5X12 WN 1441 ZNP</i>
	22		9111.405.060	MIXER HOLE CAP BROWN <i>MIXER HOLE CAP BROWN</i>
	23		9111.769.150	MIXER FLANGE <i>MIXER FLANGE</i>
	24		9111.770.060	COVER MIXER FLANGE <i>COVER MIXER FLANGE</i>
	25		NM03.012	OR ORM 0320-25 NBR <i>OR ORM 0320-25 NBR</i>
	26		9111.772.060	DISK FAN <i>VENTOLINA A DISCO MIXER '05</i>
	27		NM05.015	ПРОКЛАДКА V-RING 405 МІКСЕРА ДЛЯ КАВОМАШИН SAECO <i>V-RING MIXER '05</i>

## Model Machine

MACSAE159

ATLANTE 700 EVO

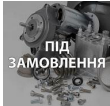
	28		9110.160.06P	ДВИГУН МІКСЕРА ДЛЯ КАВОМАШИНИ SAECO 05 24V DC SAECO 9110.1... <i>ASS.MIXER '05 24V DC GROUP 500 SAECO</i>
	29		9111.230.270	MIXER LOCKING RING NUT ORANGERAL <i>GHIERA BLOCCAGGIO MIXER ARANCIO RAL</i>
	30		9111.227.060	MIXER CASING <i>CORPO MIXER</i>
	31		9110.027.060	MIX CASING ASS. <i>ASS.CORPO MIX SAECO CRISTALLO,ATLANTE,QUARZO,RUBINO</i>
	32		9111.232.060	STD TUBE HOLDER SLEEVE <i>MANICOTTO PORTATUBO STANDARD</i>
	32		9111.233.060	DECAFF.TUBE HOLDER SLEEVE <i>MANICOTTO PORTATUBO DECAFFEINATO</i>
	33		11031815	RX ELBOW DISPENSING NOZZLE <i>RX ELBOW DISPENSING NOZZLE</i>

# Model Machine

MACSAE159

ATLANTE 700 EVO

MACSAE159.T.0009



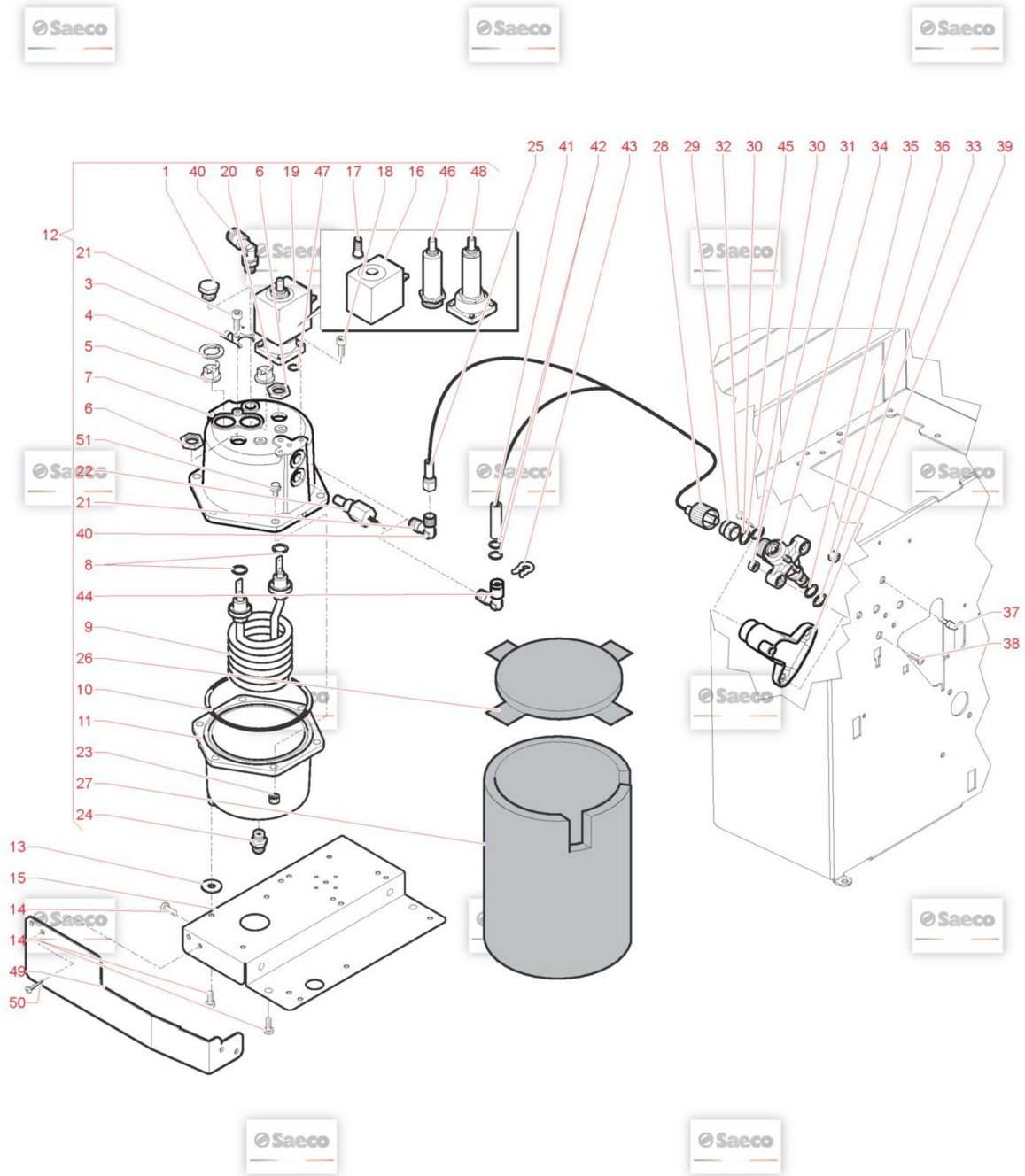













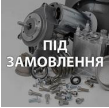







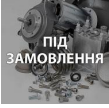

TAVOLA NR. 9 - ARTICOLO ATLANTE 700 EVO



## Model Machine

MACSAE159

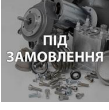
ATLANTE 700 EVO





























Web	Pos.	Foto	Item - Replace by	Description
				<i>Press - CTRL + CLICK go to item in a new window Натисніть - Ctrl + права кнопка миші щоб відкрити запчастину в новому вікні</i>
	1		12001169	BRASS CAP 1/8 GAS CONICAL TEA BRASS CAP 1/8 GAS CONICAL TEA
	2		12001052	SCREW TCEI M4,0X6 DIN 912 ZIN SCREW TCEI M4,0X6 DIN 912 ZIN
	3	 ПІД ЗАМОВЛЕННЯ	226760100	RETAINING SPRING 3 THERMOSTATS RETAINING SPRING 3 THERMOSTATS
	4		9991.085	THERMOSTAT FIXING WASHER RONDELLA FERMATERMOSTATI
	5		NE09.021	THERMOSTAT 150°C FASTON 90° TERMOSTATO 150°C FASTON 90°
	6		9991.029	NUT FOR RESISTOR DADO X RESISTENZA
	7		11012528	UPPER CASING BOILER 600CC TEA UPPER CASING BOILER 600CC TEA
	8	 ПІД ЗАМОВЛЕННЯ	11000972	OR 3050 FKM 80 FD PEROXIDICA OR 3050 FKM 80 FD PEROXIDICA
	9		11005367	HEAT ELEMENT BOILER 230V 1550W HEAT ELEMENT BOILER 230V 1550W
	10		12000770	OR ORM 4350 VITON OR METRICO 4350 IN VITON
	11		11012529	LOWER CASING BOILER 600CC TEA LOWER CASING BOILER 600CC TEA
	12	 ПІД ЗАМОВЛЕННЯ	11026694	HS2 BOILER ATL 650 230V 50HZ TEA HS2 BOILER ATL 650 230V 50HZ TEA
	12	 ПІД ЗАМОВЛЕННЯ	11030611	HS2 BOILER ATL 7000 230V 50HZ TEA C.B. HS2 BOILER ATL 7000 230V 50HZ TEA C.B.



## Model Machine

MACSAE159























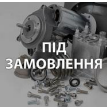

ATLANTE 700 EVO

	13		9111.501	INSULATION WASHER <i>INSULATION WASHER</i>
	14		12002039	SCREW TCBD TORX 20 M4X12 ZN-B <i>VITE TCBD TORX 20 M4X12 ZN-B</i>
	15		11008250	BOILER SUPPORT <i>BOILER SUPPORT</i>
	16		20007361	SOLENOID EVT ODE <i>SOLENOID EVT ODE</i>
	17		20007362	SPARE CORE EV ODE <i>RIC. NUCLEO EVT ODE</i>
	18		12001179	SCREW TCEI M4,0X12 UNI 5931 8.8 ZIN. <i>SCREW TCEI M4,0X12 UNI 5931 8.8 ZIN.</i>
	19		11012534	TEA ELECTROVALVE 2/3 WAY N.C. <i>TEA ELECTROVALVE 2/3 WAY N.C.</i>
	20		189428700	THERMOSTAT 175° 1NT-15L-5126 <i>THERMOSTAT 175° 1NT-15L-5126</i>
	21		11025082	1/8"G M/CONICAL ORIENT. NUT/OGV <i>1/8G M/CONICAL ORIENT. NUT/OGV</i>
	22		11005368	IMMERSION PROBE ASS. <i>ASS.SONDA TEMPER.AD.IMMERSIONE</i>
	23		U302.004	NUT HEXAGONAL M6 UNI 5588 <i>DADO ESAGONALE M6 UNI 5</i>
	24		11027089	WATER INLET CONNECTOR <i>WATER INLET CONNECTOR</i>
	25		11025406	TUBE ASSEMBLY TEFLON 3X6 L.250MM <i>TUBE ASSEMBLY TEFLON 3X6 L.250MM</i>
	26		11030776	COFFEE BOILER 600CC UPPER ISOLATOR <i>ISOLANTE SUP.CALDAIA 600CC VENDING</i>

## Model Machine

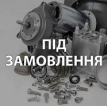
MACSAE159











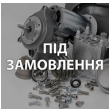



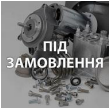





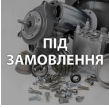

ATLANTE 700 EVO

	27		11030778	COFFEE BOILER 600CC UPPER ISOLATOR <i>ISOLANTE PERIMETR.CALDAIA 600CC VENDING</i>
	28		11005743	KNURLED FEMALE HAND BOLT M14 <i>GODRONE FEMMINA M14</i>
	29		11005741	CONNECTOR D.6 <i>BOCCOLA ESTERNA D.6</i>
	30		140321462	O-RING 2018 SILICONE <i>OR 2018 IN SILICONE</i>
	31		U302.003	GALV.NUT HEXAGONAL M4 UNI 5589ZN <i>DADO ESAGONALE M4 UNI 5588 ZNP</i>
	32		U109.037	SCREW AUT.TCB 4,8X13 DIN 7981C <i>VITE AUT.TCB 4,8X13 DIN 7981 C NIK</i>
	33	 ПІД ЗАМОВЛЕННЯ	11013174	OR ORM 0050-20 FKM 80 FD GREENPEROXIDA <i>OR ORM 0050-20 FKM 80 FD GREEN PEROXIDA</i>
	34		11005370	PIN FOR MUFF <i>PERNO X MANICOTTO PIN FOR MUFF</i>
	35	 ПІД ЗАМОВЛЕННЯ	11013173	OR ORM 0090-20 FKM 80 FD GREENPEROXIDA <i>OR ORM 0090-20 FKM 80 FD GREEN PEROXIDA</i>
	36		U324.006	NUT M4 FLANGED INDENTED BASE <i>NUT M4 FLANGED INDENTED BASE</i>
	37	 ПІД ЗАМОВЛЕННЯ	11006046	PEG FOR BOILER <i>PEG FOR BOILER</i>
	38		U044.013	SCREW TSPC M4,0X12 UNI 7688 GALV. <i>VITE TSPC M4,0X12 UNI 7688 ZNP</i>
	39	 ПІД ЗАМОВЛЕННЯ	11013431	PHEDRA TTT SLEEVE TTT CIRCUIT <i>PHEDRA TTT SLEEVE TTT CIRCUIT</i>

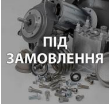
## Model Machine

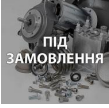
MACSAE159

ATLANTE 700 EVO

	40		12001181	BICONICAL CONNECT. L M 1/8X06TEA <i>BICONICAL CONNECT. L M 1/8X06 TEA</i>
	41		11030637	TUBE TEFLON 4X2 L.250 <i>ASS.TUBO TEFLON 4X2 L.250</i>
	42		140328059	OR 2015 SILICONE PTFE/FDA <i>OR 2015 SILICONE PTFE/FDA</i>
	43		9011.144	SS FORK FOR TUBE D=4 <i>FORCELLA X TUBO D.4</i>
	44		11029569	CONNECTOR <i>RACC.ORIENT.DADO/OGIV.1/8"CONICO TUBO D4</i>
	45		12001810	OR 275 DE.8,04 SILICONE PERNOMANICOTTO <i>OR 275 DE.8,04 SILICONE PERNO MANICOTTO</i>
	46		20007363	SPARE EVT ODE <i>SPARE EVT ODE</i>
	47		20007312	SPARE OR EVT HS2 11012534 <i>SPARE OR EVT HS2 11012534</i>
	48		20007370	SPARE EVT 11012534 <i>SPARE EVT 11012534</i>
	49		11032518	FIXING SUPPORT BOILER-PLATE <i>FIXING SUPPORT BOILER-PLATE</i>
	50		U110.004	SCREW AUT.TCB 3,5X6,5 DIN 7981F <i>VITE AUT.TCB 3,5X6,5 DIN 7981 F NIK</i>
	51		U023.020	SCREW TCEI M6X20 UNI 5931 ZIN <i>VITE TCEI M6X20 UNI 5931 8.8</i>

# Model Machine

MACSAE159

ATLANTE 700 EVO

MACSAE159.T.0010

TAVOLA NR. 10 - ARTICOLO ATLANTE 700 EVO

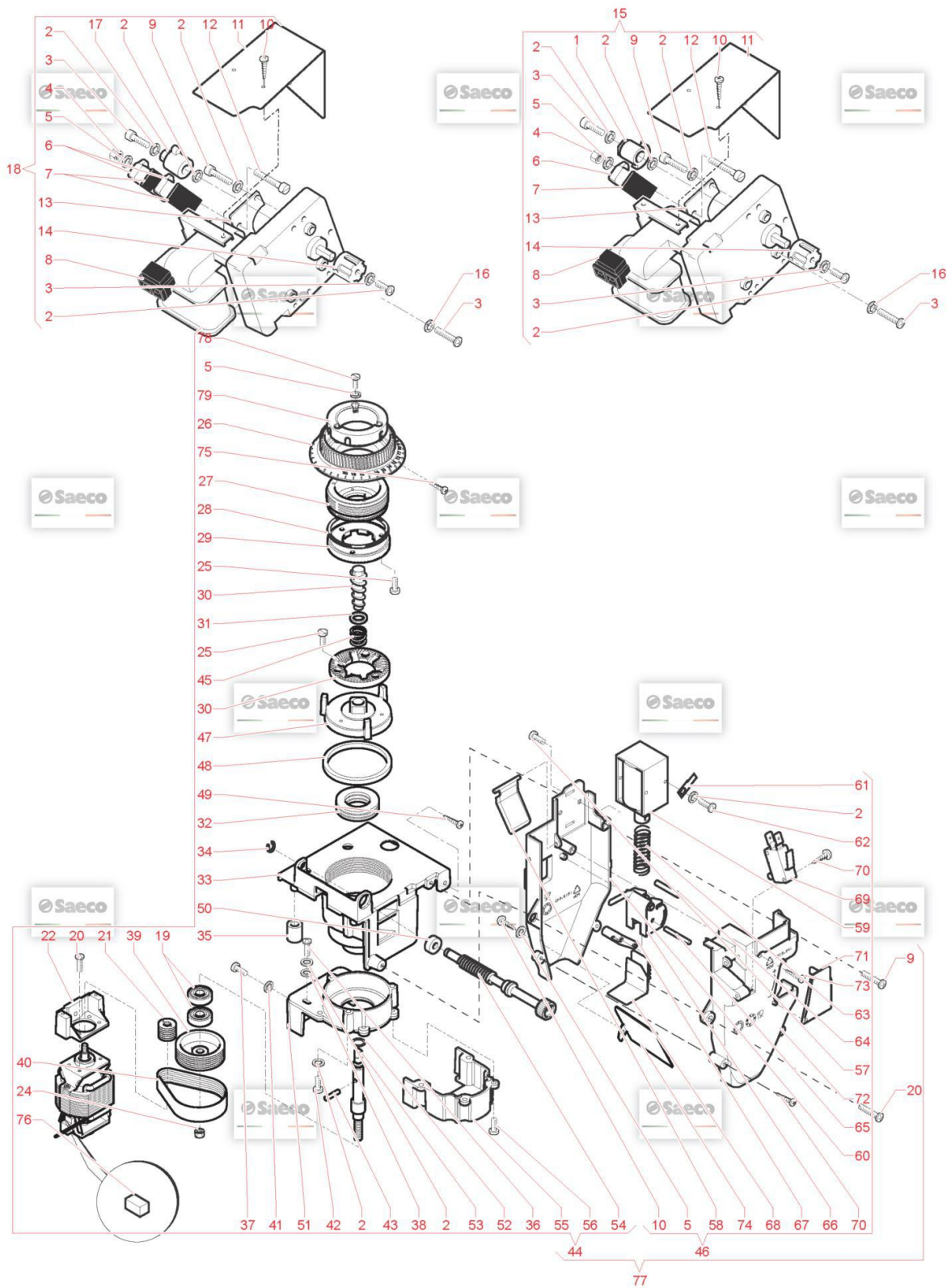

## Model Machine

MACSAE159

ATLANTE 700 EVO

Web Pos. Foto Item - Replace by Description



Press - CTRL + CLICK go to item in a new window  
Натисніть - Ctrl + права кнопка миші щоб відкрити запчастину в новому вікні



1



9991.037

CAM FOR RATIOMOTOR 1 MICRO  
CAMMA X MOTORIDUTTORE 1 MICRO



2



128310404

МЕТАЛЕВЕ УБЧАСТЕ КОЛИЩАТКО UNI 8842 A4  
WASHER UNI 8842 A4 BURNISHED



3



129824002

TCB SCREW M4X10 UNI 7687 ZNP  
VITE TCB M4X10 UNI 7687 ZNP



4



U302.002

NUT HEXAGONAL M3 UNI 5588  
NUT HEXAGONAL M3 UNI 5588



5



U208.002

TOOTHED WASHER 3,3X5,8 UNI 3703 G  
ROSETTA DENT. 3,3X5,8 UNI 3703 ZNP



6



NE05.066

MICROSWITCH CHERRY D419Q1A  
МІКРОПЕРЕМИКАЧ РЕДУКТОРА РОБОЧОЇ ГРУПИ



7



9991.014

CARD FOR MICRO SWITCHES  
CARTONCINO X MICROINTERRUPTORE



8



11032817

RATIOMOTOR 30 PACC 230/240-50  
RATIOMOTOR 30 PACC 230/240-50



8

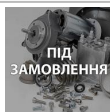

11032819

RATIOMOTOR 30 PACC 220/60  
MOTORIDUTT.IN PLASTICA PACCO 30 220/60



9



129825502

TCB SCREW M4X25 UNI 7687 ZNP  
TCB SCREW M4X25 UNI 7687 ZNP



10

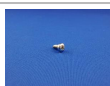

129511903

SCREW TCB 2,9X6,4 DIN 7981 BZNICK  
SCREW TCB 2,9X6,4 DIN 7981 BZ NICK



11

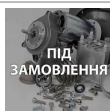

11014251

CENTRAL UNIT MOTOR STEEL CARTER  
CENTRAL UNIT MOTOR STEEL CARTER



12

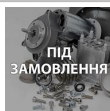











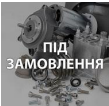















U034.003

SCREW TCI M3,0X20 UNI 6107 GALV.  
SCREW TCI M3,0X20 UNI 6107 GALV.

## Model Machine

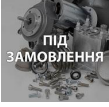
MACSAE159



























ATLANTE 700 EVO

	13		<b>11003524</b>	PLATE FOR MICRO RATIOMOTOR <i>PLATE FOR MICRO RATIOMOTOR</i>
	13		<b>9991.015</b>	PLATE FOR MICRO <i>PIASTRINA X MICRO</i>
	14		<b>9991.013</b>	JOINT FOR RATIOMOTOR <i>GIUNTO X MOTORIDUTTORE</i>
	15		<b>11025216</b>	ASS.RATIOMOTOR FOR DA 230V FS400 <i>ASS.RATIOMOTOR FOR DA 230V FS400</i>
	15		<b>11025217</b>	ASS.RATIOMOTOR FOR DA 220/60 FS400 <i>ASS.RATIOMOTOR FOR DA 220/60 FS400</i>
	16		<b>U207.002</b>	PLAIN WASHER 4,3X9 UNI 6592 GAL <i>ROSETTA PIANA 4,3X9 UNI 6592 ZNP</i>
	17		<b>11003525</b>	CAM COFFEE GROUP FRESH BREW <i>CAM COFFEE GROUP FRESH BREW</i>
	18		<b>11023414</b>	RATIOMOTOR CRISTALLO600 TTT 230V <i>RATIOMOTOR CRISTALLO600 TTT 230V</i>
	19		<b>11025696</b>	BEARING RTP 608-2Z <i>BEARING RTP 608-2Z</i>
	20		<b>12002039</b>	SCREW TCBD TORX 20 M4X12 ZN-B <i>VITE TCBD TORX 20 M4X12 ZN-B</i>
	21		<b>11025690</b>	PULLEY D.15 "GRIND 48" <i>PULLEY D.15 "GRIND 48"</i>
	22		<b>11027163</b>	MOTOR SUPPORT GRINDERS D.48 <i>MOTOR SUPPORT GRINDERS D.48</i>
	23		<b>11027396</b>	COFFEEGRINDER MOTOR D.48 230V <i>COFFEEGRINDER MOTOR D.48 230V</i>
	24		<b>U310.004</b>	NUT SELF LOCK.M6 UNI 7473 <i>NUT SELF LOCK.M6 UNI 7473</i>

## Model Machine

MACSAE159















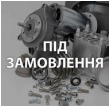











ATLANTE 700 EVO

	25		U043.007	SCREW TCBC M3,0X8 UNI 7687 GALV. SCREW TCBC M3,0X8 UNI 7687 GALV.
	26		11032640	КІЛЬЦЕ ПОМОЛУ 3A ATL700 TTT Д.48 ASS.GHIERA BLOCCATA X ATL700 TTT D.48
	26		1813.103.A20	RING NUT OF GRIND REGULATION RING NUT OF GRIND REGULATION
	27		11025692	UPPER GRINDING DISK HOLDER "GRIND 48" UPPER GRINDING DISK HOLDER "GRIND 48"
	28		12001617	OR 3206 NBR OR 3206 NBR
	29		11021838	FLAT MILL D.48 TEA FLAT MILL D.47 TEA
	30		11025695	ШНЕК БОЛТИК ЗБІЛЬШЕННЯ "MACINE 48" INCREASE SCREW "GRIND 48"
	31		11027418	SPACER FOR SCREW OF INCREASE SPACER FOR SCREW OF INCREASE
	32		11025699	BEARING RTP 51104 BEARING RTP 51104
	33		11027162	GRINDERS CAP D.48 GRINDERS CAP D.48
	34		U701.011	STEEL SNAP RING 5 UNI 7434 ANELLO ELASTICO 5 UNI 7434
	35		1813.046.050	RUBBER GRIND SUPPORT RUBBER GRIND SUPPORT
	36		12002052	ZN-B TCB SCREW M4X16 ZN-B TCB SCREW M4X16

## Model Machine

MACSAE159

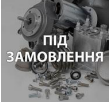
ATLANTE 700 EVO



















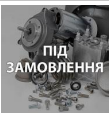







	37		<b>U023.004</b>	SCREW TCEI M6,0X12 UNI 5931 GALV. <i>VITE TCEI M6,0X12 UNI 5931 Z</i>
	38		<b>U207.004</b>	PLAIN WASHER 4,3X16 UNI 6592 GAL <i>PLAIN WASHER 4,3X16 UNI 6592 GAL</i>
	39		<b>11025689</b>	PULLEY D.40 "GRIND 48" <i>PULLEY D.40 "GRIND 48"</i>
	40		<b>11032130</b>	BELT GRINDER COFFEE <i>BELT GRINDER COFFEE</i>
	41		<b>U208.006</b>	TOOTHED WASHER 6,4X11 UNI 3703 <i>ROSETTA DENT. 6,4X11 UNI 3</i>
	42		<b>12001700</b>	SCREW TCB M4X30 UNI 7687 ZNP <i>SCREW TCB M4X30 UNI 7687 ZNP</i>
	43		<b>11025921</b>	POWER PLUG UNI-EN 28743 D.3X14 <i>POWER PLUG UNI-EN 28743 D.3X14</i>
	44		<b>11027165</b>	КАВОМОЛКА В ЗБОРІ Д 48 SAECO 11027165 <i>COFFEE GRINDER D.48</i>
	44		<b>11031412</b>	COFFEE GRINDER D.48 TTT <i>COFFEE GRINDER D.48 TTT</i>
	45		<b>11025694</b>	SPRING "GRIND 48" <i>SPRING GRIND 48</i>
	46		<b>11026301</b>	DOSER ASS. 6-11 GR. 220V <i>DOSER ASS. 6-11 GR. 220V</i>
	46		<b>11028667</b>	DOSER ASS. 6-11 GR. LX 220V P&G <i>DOSER ASS. 6-11 GR. LX 220V P&amp;G</i>
	46		<b>1813.A10.A2A</b>	DOSER ASS. 6-11 GR. <i>ASS.DOSATORE 6-11 GR.</i>
	46		<b>1813.A10.A2N</b>	DOSER ASS. 6-11 GR. 220V 60HZ <i>DOSER ASS. 6-11 GR. 220V 60HZ</i>

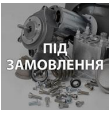

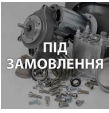
## Model Machine

MACSAE159

























ATLANTE 700 EVO

	47		11025691	ТРИМАЧ НИЖНЬОГО НОЖА Д.48 <i>LOWER GRINDING DISK HOLDER GRIND 48</i>
	48		11027451	ПРОКЛАДКА DE=47,4 DI=41,4H=4 IN F <i>ПРОКЛАДКА DE=47,4 DI=41,4H=4 IN F</i>
	49		U116.006	SCREW AUT.PT TCB 3,5X12 WN 1441 ZNP <i>VITE AUT.PT TCB 3,5X12 WN 1441 ZNP</i>
	50		1813.159	ANTIVIBRATION RUBBER <i>ANTIVIBRATION RUBBER</i>
	51	 ПІД ЗАМОВЛЕННЯ	11027164	MOTOR SUPPORT GRINDERS D.48 <i>MOTOR SUPPORT GRINDERS D.48</i>
	52		140321662	O-RING 2021 SILICONE <i>OR 2021 IN SILICONE</i>
	53		11025693	CENTRAL PIN "GRIND 48" <i>CENTRAL PIN "GRIND 48"</i>
	54		1813.104.A20	ADJUSTMENT SCREW WITH TUBE HOLDER <i>VITE REGOLAZIONE MACININO</i>
	55		11027186	SHELL CLOSURE BELT <i>SHELL CLOSURE BELT</i>
	56	 ПІД ЗАМОВЛЕННЯ	U127.010	SCREW TAPT.TCB M4,0X10 DIN 7500C <i>SCREW TAPT.TCB M4,0X10 DIN 7500C</i>
	57	 ПІД ЗАМОВЛЕННЯ	12002151	TSP SCREW M3X4 UNI 7688 SS <i>TSP SCREW M3X4 UNI 7688 SS</i>
	58	 <small>Liberty</small>	1813.042.A20	DISPENSER PALLET <i>DISPENSER PALLET</i>
	59		9121.235.00A	ELECTROMAGNET FOR DISPENSER WITH NUCLEUS <i>ELETTROM. PER DOSATORE CON NUCLEO</i>
	59		9121.235.00N	ЕЛЕКТРОМАГНІТ ДЛЯ ДОЗАТОРА W/NUCLEUS 220V <i>ELECTROMAGNET X DISPENSER W/NUCLEUS 220V</i>

## Model Machine

MACSAE159

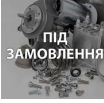









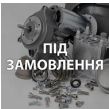



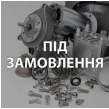

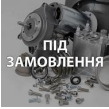



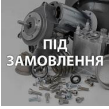

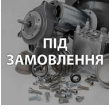

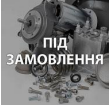
ATLANTE 700 EVO

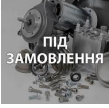
	60		11026302	DISPENSER SHELL <i>DISPENSER SHELL</i>
	60		1813.040.A20	DISPENSER SHELL <i>GUSCIO DOSATORE</i>
	61		NE15.003	MALE TONGUE PLAIN 6,3 D.5,2 <i>LINGUETTA MASCHIO PIANA 6,3 D.5,2</i>
	62		129821402	TCB SCREW M3X4 UNI 7687 ZNP <i>TCB SCREW M3X4 UNI 7687 ZNP</i>
	63		1813.127	SPRING FOR ELECTROMAGNET <i>MOLLA X ELETTROMAGNETE DOSAT</i>
	64		1813.092	PIN <i>PIN</i>
	65		1813.091	PIN FOR DISPENSER REGULATION <i>PIN FOR DISPENSER REGULATION</i>
	66		1813.043.A20	DISPENSER REGULATION <i>REGOLATORE DOSATORE</i>
	67		1813.078.A20	ADJUSTMENT LEVER <i>ADJUSTMENT LEVER</i>
	68		1813.044.A20	PALLET FOR REGULATION <i>PALETTA X REGOLATORE</i>
	69		NE05.062	MICROSWITCH + WHEEL <i>MICROINTERRUTTORE C/ROTELLA</i>
	70		U116.004	SCREW AUT.PT TCB 3,0X16 WN 1441 <i>SCREW AUT.PT TCB 3,0X16 WN 1441</i>
	71		1813.191.A20	DISPENSER COVER <i>COPERTURA DOSATORE</i>

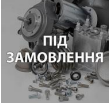
## Model Machine

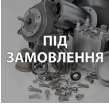
MACSAE159

ATLANTE 700 EVO

	72		<b>11026303</b>	OUTSIDE SHELL DISPENSER <i>OUTSIDE SHELL DISPENSER</i>
	72		<b>1813.041.A20</b>	OUTSIDE SHELL DISPENSER <i>OUTSIDE SHELL DISPENSER</i>
	73		<b>12000390</b>	SCREW AUT.TCB 2,9X25 DIN 7981C NIK <i>SCREW AUT.TCB 2,9X25 DIN 7981 C NIK</i>
	74		<b>11026304</b>	TUBE CONVEYOR COFFEE LX ATL650 <i>TUBE CONVEYOR COFFEE LX ATL650</i>
	75		<b>U109.004</b>	SCREW AUT.TCB 4,8X9,5 DIN 7981C <i>VITE AUT.TCB 4,8X9,5 DIN 798</i>
	76		<b>20007420</b>	MOTOR BRUSH <i>MOTOR BRUSH</i>
	77		<b>11027395</b>	COFFEE GRINDER D.48 + DISPENCER <i>COFFEE GRINDER D.48 + DISPENCER</i>
	77		<b>11027721</b>	COFFEE GRINDER D.48 + DISPENCER LX <i>COFFEE GRINDER D.48 + DISPENCER LX</i>
	77		<b>11031411</b>	COFFEE GRINDER D.48 + DISPENCER <i>COFFEE GRINDER D.48 + DISPENCER</i>
	77		<b>11032631</b>	COFFEE GRINDER D.48+DISPENCER220V/60HZ <i>COFFEE GRINDER D.48+DISPENCER 220V/60HZ</i>
	77		<b>11032637</b>	COFFEE GRINDER D.48+DISPENCERLX 220/60 <i>COFFEE GRINDER D.48+DISPENCERLX 220/60</i>
	78		<b>U043.023</b>	SCREW TCBC M3,0X18 UNI 7687 GALV. <i>VITE TCBC M3,0X18 UNI 7687 ZNP</i>
	79		<b>11032110</b>	BUSH <i>BUSH</i>

# Model Machine

MACSAE159

ATLANTE 700 EVO

MACSAE159.T.0011

TAVOLA NR. 11 - ARTICOLO ATLANTE 700 EVO

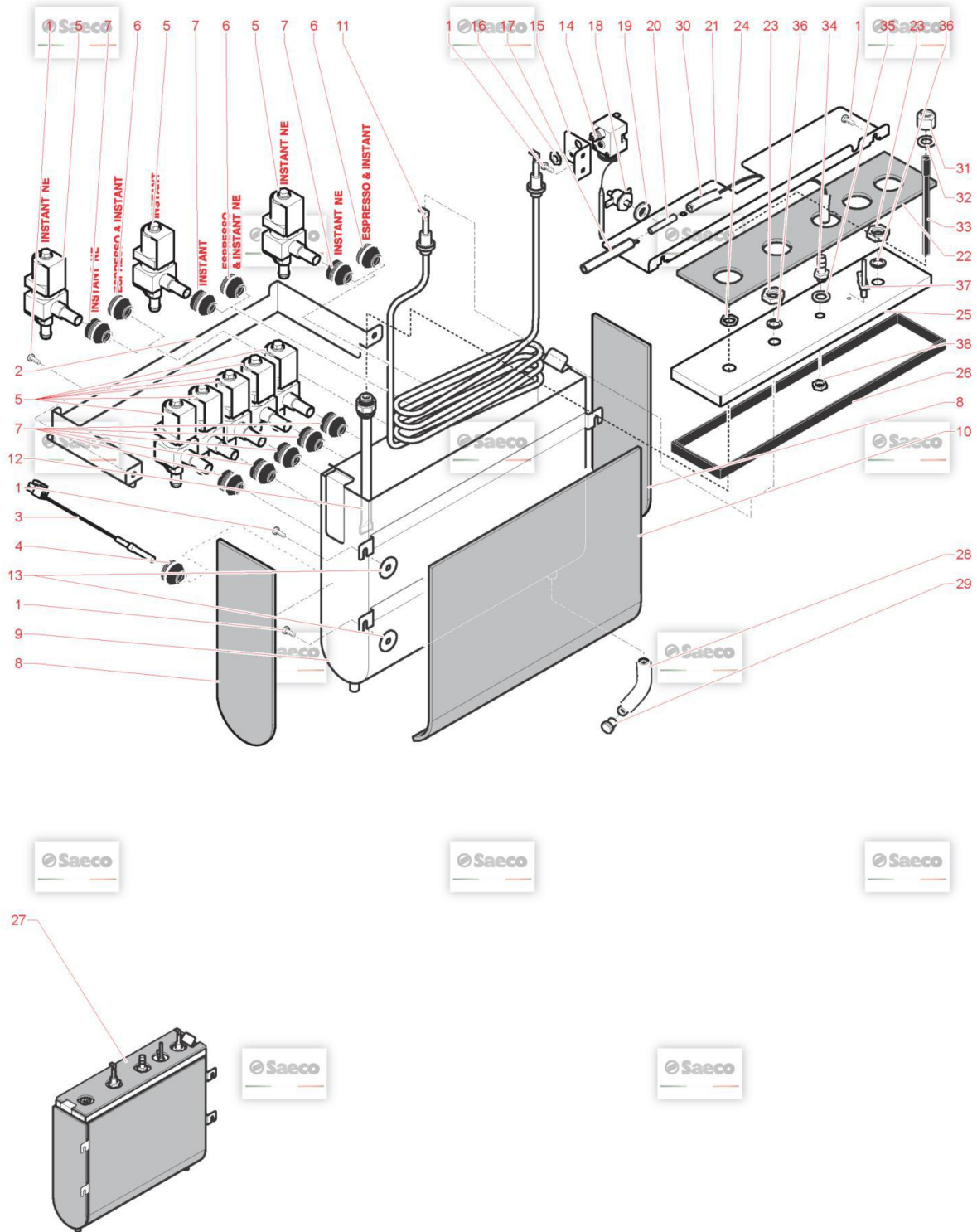

## Model Machine

MACSAE159

ATLANTE 700 EVO

Web Pos. Foto Item - Replace by Description



Press - CTRL + CLICK go to item in a new window

Натисніть - Ctrl + права кнопка миші щоб відкрити запчастину в новому вікні



1



U127.011

SCREW TAPT.TCB M5,0X8 DIN 7500C

SCREW TAPT.TCB M5,0X8 DIN 7500C



2

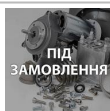

11012505

OMEGA FIXING FOR SOLUBLES ELECTROVALVE

OMEGA FIXING FOR SOLUBLES ELECTROVALVE



3



NE13.065

SOLUBLES PROBE ASS.

ASS.SONDA SOLUBILI



4

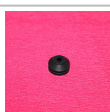

9011.210

TUBE GROMMET IMMERSION PROBE D6

TUBE GROMMET IMMERSION PROBE D6



5



11032608

SOLUBLE ELECTROVALVE 24VDC ODE

SOLUBLE ELECTROVALVE 24VDC ODE



6



9011.195

PLUG FOR BOILER

PLUG FOR BOILER



7



9111.507

СИЛІКОНОВА РЕЗИНКА БОЙЛЕРА ДЛЯ РОЗЧИННИХ РЕЧОВИН

PASSATUBO X ELETTROV. CALDAIA



8

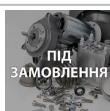

11009951

SIDE BOILER ISOLATOR

SIDE BOILER ISOLATOR



9

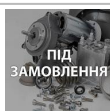

11008277

ASS.BOILER

ASS.BOILER



10

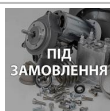

11009889

FRONTAL-BACK BOILER ISOLATOR

FRONTAL-BACK BOILER ISOLATOR



11



11008282

BOILER HEAT ELEMENT 230V 2160W

BOILER HEAT ELEMENT 230V 2160W



12



9110.068

ASS.TUBE FOR LIMITER

ASS.TUBE FOR LIMITER



13



9111.501













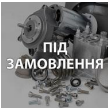



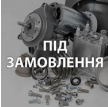







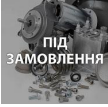

INSULATION WASHER

INSULATION WASHER

## Model Machine

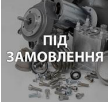
MACSAE159

















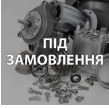





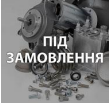

ATLANTE 700 EVO

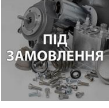
	14		<b>NE09.035</b>	LIMITER TY95H <i>LIMITATORE A RIARMO MANUALE TY95H</i>
	15		<b>9111.598</b>	SUPPORT <i>SUPPORT</i>
	16		<b>NV99.093</b>	NUT <i>NUT</i>
	17		<b>9972.226</b>	SILICONE TUBE 7X11 L.90MM <i>SILICONE TUBE 7X11 L.90 MM</i>
	18		<b>NE09.029</b>	UNIPOLAR THERMOSTAT MANUAL RESET <i>TERMOSTATO UNIPOLARE RIARMO MANUALE</i>
	19		<b>NV99.071</b>	PLAIN WASHER 5,5X12 IN COPPER <i>PLAIN WASHER 5,5X12 IN COPPER</i>
	20		<b>0871.164</b>	TUBE FOR THERMOSTAT <i>TUBE FOR THERMOSTAT</i>
	21		<b>11009895</b>	SEPARATOR BOILER SG650 <i>SEPARATOR BOILER SG650</i>
	22		<b>11009952</b>	UPPER BOILER ISOLATOR <i>UPPER BOILER ISOLATOR</i>
	23		<b>9991.029</b>	NUT FOR RESISTOR <i>DADO X RESISTENZA</i>
	24		<b>WGAND01/016</b>	1/4" GAS NUT <i>1/4" GAS NUT</i>
	25		<b>11008273</b>	BOILER LID <i>BOILER LID</i>
	26		<b>11011556</b>	BOILER SEAL SOLUBLES ATLANTE <i>BOILER SEAL SOLUBLES ATLANTE</i>
	27		<b>11008276</b>	ASS.BOILER 230V <i>ASS.BOILER 230V</i>

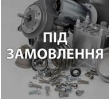
## Model Machine

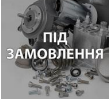
MACSAE159

ATLANTE 700 EVO

	27		<b>11010384</b>	ASS.BOILER 230V SG650 INSTANT <i>ASS.BOILER 230V SG650 INSTANT</i>
	27		<b>11031765</b>	ASS.BOILER 230V ATL700 INSTANT <i>ASS.BOILER 230V ATL700 INSTANT</i>
	27		<b>11031925</b>	ASS.BOILER 230V ATL700 INST.AB <i>ASS.BOILER 230V ATL700 INST.AB</i>
	28		<b>9972.313</b>	SILICONE TUBE 7X11 L.170MM <i>SILICONE TUBE 8X12 L.170 MM</i>
	29		<b>NV03.006</b>	CAP KAPSTO LPN 615/010 <i>TAPPO KAPSTO LPN 615/010</i>
	30		<b>9972.141</b>	SILICONE TUBE 7X11 L.160MM <i>SILICONE TUBE 7X11 L.160 MM</i>
	31		<b>9181.135</b>	NUT 1/4 TUBE D.8 PROFI <i>NUT 1/4 TUBE D.8 PROFI</i>
	32		<b>U207.005</b>	PLAIN WASHER 6,4X11 UNI 6592 GAL <i>PLAIN WASHER 6,4X11 UNI 6592 GAL</i>
	33		<b>1812.070</b>	RUBBER <i>RUBBER</i>
	34		<b>0871.141</b>	MALE RUBBER HOLDER CYL. D.9 <i>MALE RUBBER HOLDER CYL. D.9</i>
	35		<b>0871.140</b>	COPPER WASHER <i>COPPER WASHER</i>
	36		<b>11000972</b>	OR 3050 FKM 80 FD PEROXIDICA <i>OR 3050 FKM 80 FD PEROXIDICA</i>
	37		<b>12002060</b>	RIVET GROUND ONE TERMINAL 1000071 <i>RIVET GROUND ONE TERMINAL 1000071</i>

## Model Machine

MACSAE159

ATLANTE 700 EVO



38



0871.139

HEXAGONAL NUT CH.14 1/8" GAS

"HEXAGONAL NUT CH.14 1/8" GAS"

---



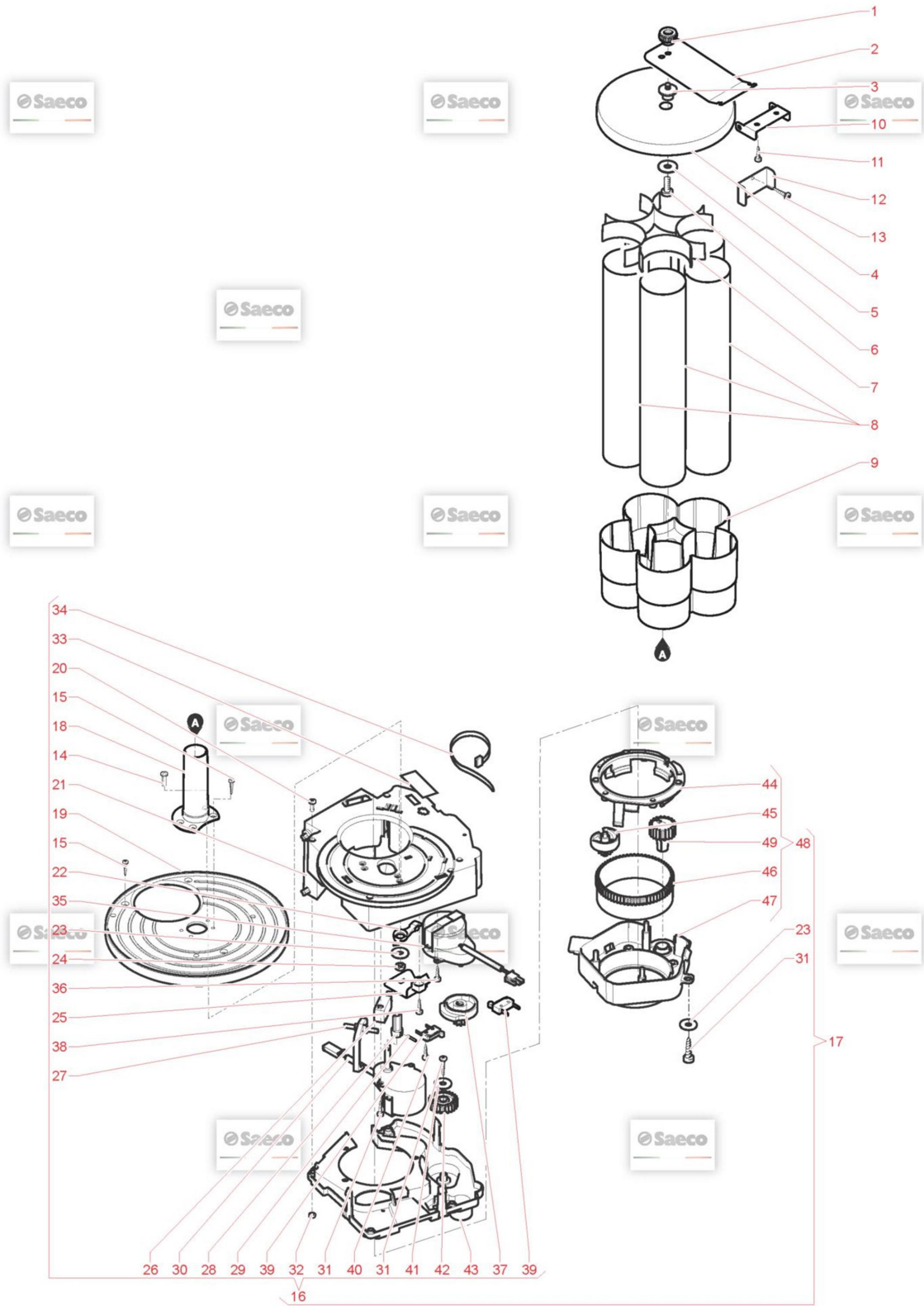

## Model Machine

MACSAE159

ATLANTE 700 EVO

Web Pos. Foto Item - Replace by Description



Press - CTRL + CLICK go to item in a new window

Натисніть - Ctrl + права кнопка миші щоб відкрити запчастину в новому вікні



1



12002034

KNOB WITH BUSH M5

*KNOB WITH BUSH M5*



2

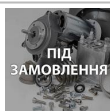

11009678

BASKET STOP PLATE SG650

*BASKET STOP PLATE SG650*



3



11010585

CENTRAL PIN FOR CUP COLUMN

*CENTRAL PIN FOR CUP COLUMN*



4

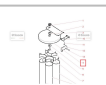

11009310

TANK LID GLASSES

*TANK LID GLASSES*



5

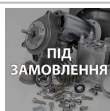

U207.009

PLAIN WASHER 5,5X15 UNI 6593 GA

*PLAIN WASHER 5,5X15 UNI 6593 GA*



6



U043.021

SCREW TCBC M5,0X8 UNI 7687 GALV.

*VITE TCBC M5,0X8 UNI 7687 ZNP*



7



11009242

CUP TUBE FIXING SPRING

*CUP TUBE FIXING SPRING*



8



11001422

TUBE PVC 80X1.5 L=705

*TUBE PVC 80X1.5 L=705*



9



11008470

GLASSES BASKET 5 COLUMN

*GLASSES BASKET 5 COLUMN*



10



11009680

BASKET STOP BRACKET SG650

*BASKET STOP BRACKET SG650*



11



U109.003

SCREW TCB 3,5X9,5 DIN 7981 C NICK

*SCREW TCB 3,5X9,5 DIN 7981 C NICK*



12

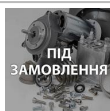

1813.162

BRACKET STOP DISPENCER

*BRACKET STOP DISPENCER*



13



U110.004











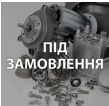

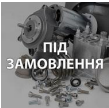











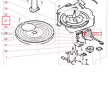

SCREW AUT.TCB 3,5X6,5 DIN 7981F

*VITE AUT.TCB 3,5X6,5 DIN 7981 F NIK*

## Model Machine

MACSAE159



























ATLANTE 700 EVO

	14		<b>U044.021</b>	SCREW TSP M3,0X20 UNI 7688 SS <i>SCREW TSP M3,0X20 UNI 7688 SS</i>
	15		<b>129914102</b>	SCREW TSP TORX 10 3,5X12 PLAST.ZN-B <i>SCREW TSP TORX 10 3,5X12 PLAST.ZN-B</i>
	16		<b>11009682</b>	ASS.DISPENSER 5 COLUMNS <i>ASS.DISPENSER 5 COLUMNS</i>
	17		<b>11009681</b>	ASS.DISPENSER GLASSES 5 COLUMN <i>ASS.DISPENSER GLASSES 5 COLUMN</i>
	17		<b>11030331</b>	ASS.DISPENSER GLASSES D73 5 COLUMN <i>ASS.DISPENSER GLASSES D73 5 COLUMN</i>
	18		<b>11000642</b>	TUBE FOR BASKET GLASSES <i>CANOTTO PER CESTELLO BICCHIERI</i>
	19		<b>11008472</b>	5 COLUMN SURFACE <i>5 COLUMN SURFACE</i>
	20		<b>U034.001</b>	SCREW TCI M3,0X30 UNI 6107 GALV. <i>VITE TCI M3,0X30 UNI 6107 ZNP</i>
	21		<b>11000785</b>	ВЕРХНІЙ КОРПУС БЛОКУ ВИДАЧІ СТАКАНІВ <i>CORPO SUPERIORE DISTRIBUTORE BICCHIERI</i>
	22		<b>11007354</b>	LEVER <i>LEVER</i>
	23		<b>U212.006</b>	WASHER 3,2X11X0,5 ZNP <i>WASHER 3,2X11X0,5 ZNP</i>
	24		<b>U310.001</b>	GALV.SELF LOCK. NUT M3 UNI 7473 <i>DADO AUTOBLOC M3 UNI 7473 ZNP</i>
	25		<b>11007356</b>	MICRO COVER <i>MICRO COVER</i>
	26		<b>NE05.065</b>	MICROSWITCH CHERRY D41R-QGAD_61 <i>MICROINTERRUTTORE CHERRY D419Q1A ATLANTE CRISTALLO NEXTAGE</i>

## Model Machine

MACSAE159









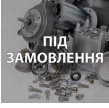

ATLANTE 700 EVO

	27		1813.067.A20	LEVER <i>LEVA PRESENZA BICCHIERI</i>
	28		11007355	CAM <i>CAMMA CENTRAGGIO 5 COLONNE CAM NUOVO PREZZO 1,2 EURO SA...</i>
	29		11009494	BRASS FOR MOTOR SAIA UDS1 COD.416616310 <i>BRASS FOR MOTOR SAIA UDS1 COD.416616310</i>
	30		11009493	MOTOR SAIA UDS1UD5M75CAN3KZ286 <i>MOTORE SAIA UDS1UD5M75CAN3KZ28 MOTOR SAIA UDS1UD5M75CAN3...</i>
	31		U116.005	SCREW AUT.PT TCB 3,0X8 WN 1441 <i>VITE AUT.PT TCB 3,0X8 WN 1441 ZNP</i>
	32		U324.005	NUT M3 FLANGED INDENTED BASE <i>DADO M3 FLANGIATO BASE DENTELLATA</i>
	33		11001467	ADHESIVE LABEL PVC 54X30 MM <i>ADHESIVE LABEL PVC 54X30 MM</i>
	34		144320200	SELF LOCK STRIP W=2.6 L=200 <i>SELF LOCK STRIP W=2.6 L=200</i>
	35		9121.226.00A	MOTOR SAIA UDS 5 RPM 220V <i>MOTORE SAIA UDS 5 RPM 220V</i>
	36		U109.005	SCREW AUT.TCB 3,5X16 DIN 7981C <i>VITE AUT.TCB 3,5X16 DIN 798</i>
	37		1863.066.A20	DISENGAGE CAM GLASSES <i>DISENGAGE CAM GLASSES</i>
	38		NE05.064	MICROSWITCH SAIA V4NC <i>MICROINTERRUTTORE SAIA V4NC</i>
	39		U109.018	SCREW AUT.TCB 3,5X6,5 DIN 7981C <i>SCREW AUT.TCB 3,5X6,5 DIN 7981 C</i>

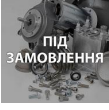
## Model Machine

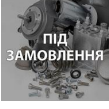
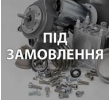
MACSAE159

ATLANTE 700 EVO

	40		<b>129510503</b>	SCREW TCB 2,2X12,7 DIN 7981 NICK SCREW TCB 2,2X12,7 DIN 7981 NICK
	41		<b>U201.001</b>	PLAIN WASHER 3,2X9 DIN 7349 GALV. PLAIN WASHER 3,2X9 DIN 7349 GALV.
	42		<b>1813.068.A20</b>	TOOTHED WHEEL TOOTHED WHEEL
	43		<b>1813.062.A20</b>	LOWER CASING DISPENSER GLASSES LOWER CASING DISPENSER GLASSES
	44		<b>11000786</b>	RETAINING RING RETAINING RING
	45		<b>1813.072.A20</b>	SNAIL FOR GLASSES D.70 CHIOCCIOLA X BICCHIERI
	45		<b>1813.192.050</b>	SNAIL FOR GLASSES D.73 CHIOCCIOLA X BICCHIERI D.73
	46		<b>1813.073.A20</b>	TOOTHED WHEEL FOR SNAIL TOOTHED WHEEL FOR SNAIL
	47		<b>11000833</b>	SNAIL SUPPORT SNAIL SUPPORT
	48		<b>11000835</b>	ASS.SNAIL SUPPORT ASS.SNAIL SUPPORT
	48		<b>11000863</b>	ASSEMBLY SUPPORT ASSEMBLY SUPPORT
	49		<b>1813.074.A20</b>	TOOTHED WHEEL TOOTHED WHEEL

# Model Machine

MACSAE159

ATLANTE 700 EVO

MACSAE159.T.0013

TAVOLA NR. 13 - ARTICOLO ATLANTE 700 EVO

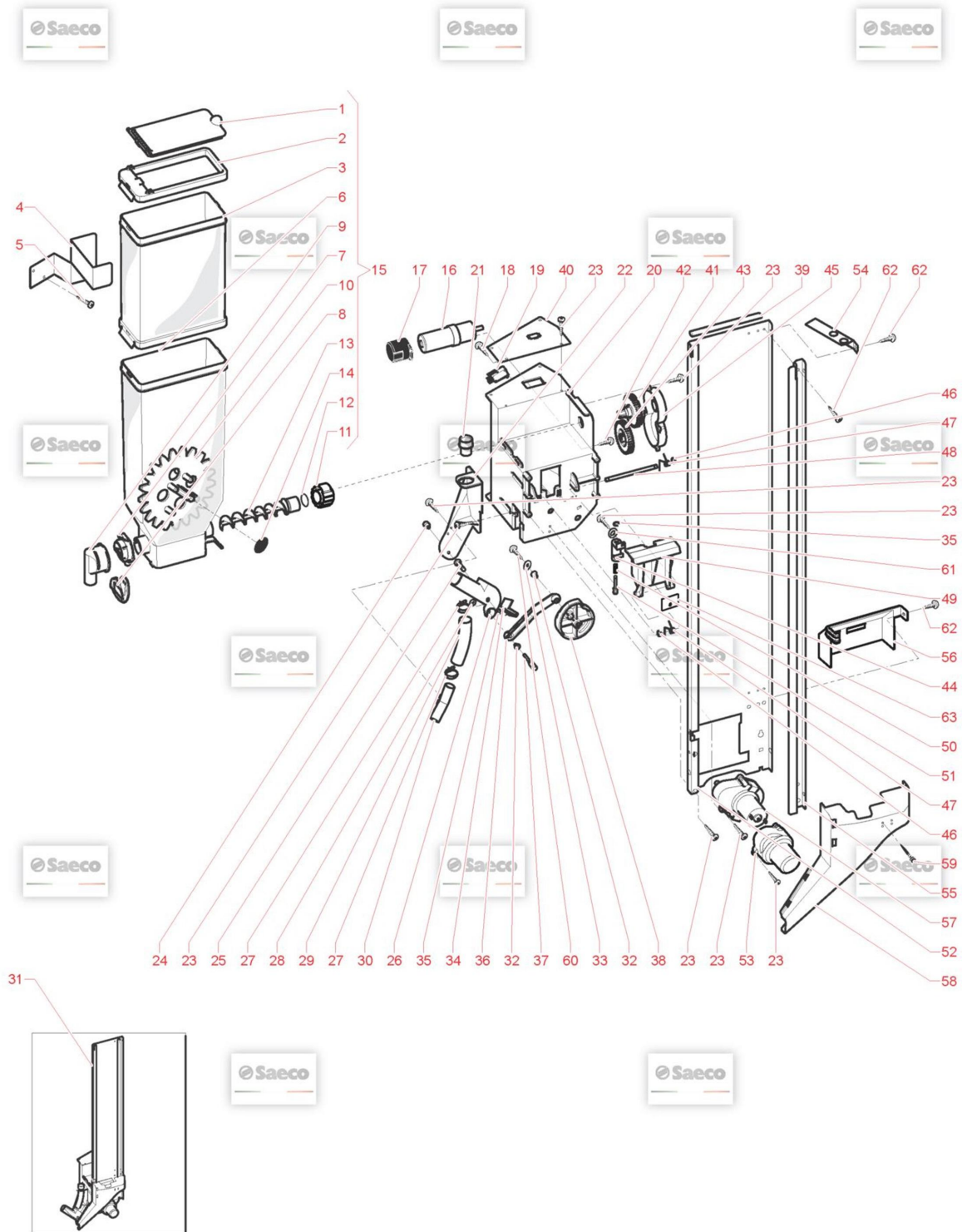

## Model Machine

MACSAE159

ATLANTE 700 EVO

Web Pos. Foto Item - Replace by Description



Press - CTRL + CLICK go to item in a new window

Натисніть - Ctrl + права кнопка миші щоб відкрити запчастину в новому вікні



1



9111.683

SOLUBLE COVER

COPERCHIETTO SOLUBILI



2



9111.696

COVER SUGAR CONTAINER

COPERCHIO CONTENITORE ZUCCHERO



3



11004610

EXTENSION FOR CONTAINER SUGAR

PROLUNGAX CONTENITORE ZUCCHERO



4



11009957

PLATE STOP CONTAINER SUGAR SG650

PLATE STOP CONTAINER SUGAR SG650



5



U109.003

SCREW TCB 3,5X9,5 DIN 7981 C NICK

SCREW TCB 3,5X9,5 DIN 7981 C NICK



6



9111.685

SUGAR CONTAINER

CONTENITORE ZUCCHERO



7



9111.630.060

BUSH FOR POWDERS TANK

BOCCOLA X SERBAT.POLVERI C/AGGANCI



8



9111.338.270

BULKHEAD FOR APERT. CLOSURE ORANGE

PARATIA CHIUSURA BOCCHETTA ARANCIO



9



9111.629.060

APERTURE FOR SOLUBLES HOPPER

APERTURE FOR SOLUBLES HOPPER



10



11032878

ШЕСТЕРНЯ КОНТЕЙНЕРА ДЛЯ ЦУКРУ (EX 9111.725)

CONTAINER WHEEL SUGAR BPA FREE



11



11012130

BACK BUSH REINFORCE

BACK BUSH REINFORCE



12



NM03.013

OR 2,3X15 NBR

OR 2,3X15 NBR



13



9111.726











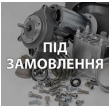

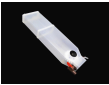













SCROLL SCREW SUGAR CONTAINER

COCLEA CONTENITORE ZUCCHERO

## Model Machine

MACSAE159

ATLANTE 700 EVO

















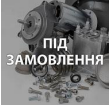







	14	 ПІД ЗАМОВЛЕННЯ	<b>9111.646</b>	ADHESIVE FOR TANK <i>ADHESIVE FOR TANK</i>
	15		<b>11005129</b>	ASSEMBLY SUGAR CONTAINER <i>ASS.CONT.ZUCCHERO CON PROLUNGA</i>
	16		<b>9121.106.00P</b>	SUGAR RATIOMOTOR 24V DC <i>MOTORIDUTTORE ZUCCHERO 24V D.C.</i>
	17		<b>9121.155</b>	HOOD FOR RATIOMOTOR <i>CUFFIA X MOTORIDUTTORE</i>
	18	 ПІД ЗАМОВЛЕННЯ	<b>U110.007</b>	SCREW AUT.TCB 2,9X16 DIN 7981F ZNP <i>SCREW AUT.TCB 2,9X16 DIN 7981 F ZNP</i>
	19		<b>NE05.002</b>	МІКРОВИМИКАЧ ДЛЯ КАВОМАШИНИ EF83161.8 <i>MICROINTERRUTTORE</i>
	20	 ПІД ЗАМОВЛЕННЯ	<b>9111.684.A20</b>	SUPPORT STIRRER <i>SUPPORTO PALETTIERA</i>
	21		<b>9111.699</b>	APERTURE SUGAR TUBE <i>BOCCHETTA TUBO ZUCCHERO</i>
	22		<b>9111.686.A20</b>	SUPPORT SUGAR CONVEYER <i>SUPPORTO BASCULINA ZUCCHERO</i>
	23		<b>U116.006</b>	SCREW AUT.PT TCB 3,5X12 WN 1441 ZNP <i>VITE AUT.PT TCB 3,5X12 WN 1441 ZNP</i>
	24		<b>11000388</b>	KNOB M3 SUGAR CONVEYER <i>POMELLO M 3 BASCULINA ZUCCHERO</i>
	25		<b>11000389</b>	GRAINED PIVOT SUGAR COVEYER <i>PERNO ZIGRINATO BASCULINA ZUCCHERO</i>
	26		<b>9111.690</b>	SUGAR CONVEYER <i>BASCULINA ZUCCHERO</i>
	27	 ПІД ЗАМОВЛЕННЯ	<b>9111.553</b>	SELF-ENERGIZING SPRING FOR TUBE D.2 <i>SELF-ENERGIZING SPRING FOR TUBE D.2</i>

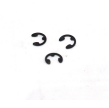

## Model Machine

MACSAE159











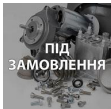















ATLANTE 700 EVO

	28		123160302	NUT M3 HIGH UNI 5587 GALVANIZED <i>NUT M3 HIGH UNI 5587 GALVANIZED</i>
	29		9111.700	SUGAR TUBE <i>TUBO ZUCCHERO</i>
	30		9111.697	CONNECTOR SUGAR TUBE <i>RACCORDO TUBO ZUCCHERO</i>
	31		11009170	ASS.SUGAR/SPOONS DISPENDER 24VDC SG650 <i>ASS.SUGAR/SPOONS DISPENDER 24VDC SG650</i>
	31		11010382	STIRRER DISPENSER ASS. SG650 INSTANT <i>STIRRER DISPENSER ASS. SG650 INSTANT</i>
	32		9111.705	SPHERICAL PIN <i>PERNO SFERICO</i>
	33		U201.001	PLAIN WASHER 3,2X9 DIN 7349 GALV. <i>PLAIN WASHER 3,2X9 DIN 7349 GALV.</i>
	34		9111.727	BULKHEAD SUGAR CONVEYER <i>PARATIA BASCULINA ZUCCHERO</i>
	35		U701.011	STEEL SNAP RING 5 UNI 7434 <i>ANELLO ELASTICO 5 UNI 7434</i>
	36		9111.691	CONNECTING ROD SUGAR DISPENCER <i>BIELLA DISTRIBUTORE ZUCCHERO</i>
	37		11004295	KNOB FOR SUGAR CONNECTING RODPIPE <i>POMELLO BLOCCAGGIO BIELLA TUBO ZUCCH.</i>
	38		11008685	SUGAR CAM <i>SUGAR CAM</i>
	39		9111.668	STIRRER DISP.COUNTERWEIGHT D.10 <i>CONTRAPPESO PALETTE D.10</i>

## Model Machine

MACSAE159











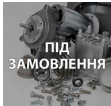



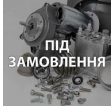

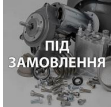



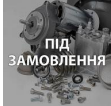

ATLANTE 700 EVO

	39		9111.669	STIRRER DISP.COUNTERWEIGHT D.10 <i>STIRRER DISP.COUNTERWEIGHT D.10</i>
	39		9111.745	STIRRER DISP.COUNTERWEIGHT <i>CONTRAPPESO PALETTE L=113MM</i>
	40		9111.707	REINFORCING PLATE <i>PIASTRA RINFORZO PALETTIERA</i>
	41		9111.694	JOINT WITH GEAR <i>GIUNTO CON INGRANAGGIO</i>
	42		U116.005	SCREW AUT.PT TCB 3,0X8 WN 1441 <i>VITE AUT.PT TCB 3,0X8 WN 1441 ZNP</i>
	43		9111.695	GEAR Z40 <i>INGRANAGGIO Z 40</i>
	44		9111.737	SUPPORT <i>SUPPORT</i>
	45		9111.687.A20	GEAR COVER <i>COPERCHIO INGRANAGGI</i>
	46		U701.006	SNAP RING 3,2 UNI 7434 <i>ANELLO ELASTICO 3,2</i>
	47		9111.730	SPRING <i>MOLLA ESPULSORE PALETTE</i>
	48		9111.376	PIN FOR STIRRER EXPELLER <i>PIN FOR STIRRER EXPELLER</i>
	49		11011240	STIRRER EXPELLER BLACK NEW <i>STIRRER EXPELLER BLACK NEW</i>
	50		11031341	SPRING <i>SPRING</i>
	51		11002209	PIN <i>PIN</i>

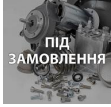
## Model Machine

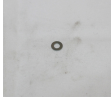
MACSAE159

ATLANTE 700 EVO

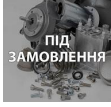
	52		11009171	STIRRER GUIDE ADJUSTABLE 90-115 SG650 <i>STIRRER GUIDE ADJUSTABLE 90-115 SG650</i>
	53		11025411	CRISTALLO SPOON'S MOTOR COVER <i>CRISTALLO SPOON'S MOTOR COVER</i>
	54		11009172	BRACKET FOR STIRRER GUIDE SG650 <i>BRACKET FOR STIRRER GUIDE SG650</i>
	55		11009139	STIRRER GUIDE SG650 <i>STIRRER GUIDE SG650</i>
	56		11007444	CARTER <i>CARTER</i>
	57		11025284	MOTORIDUTTORE FIBER 37RPM <i>MOTORIDUTTORE FIBER 37RPM</i>
	58		9111.698.A20	STIRRER SLIDE <i>SCIVOLO PALETTE</i>
	59		9161.082	RUBBER COUPLER <i>AGGANCIO IN GOMMA</i>
	60		U116.004	SCREW AUT.PT TCB 3,0X16 WN 1441 <i>SCREW AUT.PT TCB 3,0X16 WN 1441</i>
	61		U207.003	PLAIN WASHER 3,2X7 UNI 6592 GALV. <i>PLAIN WASHER 3,2X7 UNI 6592 GALV.</i>
	62		U110.004	SCREW AUT.TCB 3,5X6,5 DIN 7981F <i>VITE AUT.TCB 3,5X6,5 DIN 7981 F NIK</i>
	63		11025089	PLATE REINFORCEMENT <i>PIASTRINA RINFORZO ESPULSORE</i>

# Model Machine

MACSAE159

ATLANTE 700 EVO

MACSAE159.T.0014

TAVOLA NR. 14 - ARTICOLO ATLANTE 700 EVO

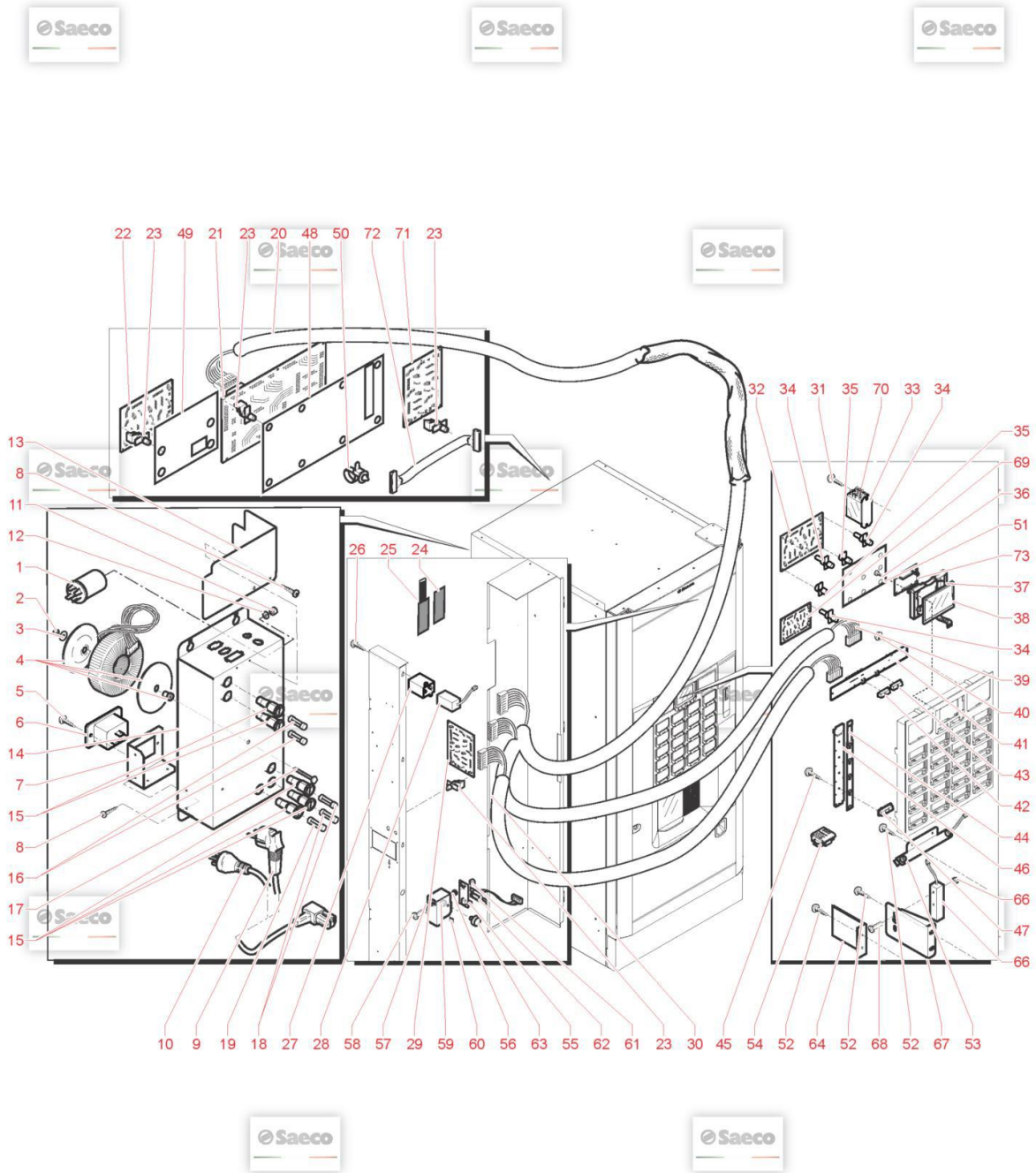

## Model Machine

MACSAE159

ATLANTE 700 EVO

Web Pos. Foto Item - Replace by Description



Press - CTRL + CLICK go to item in a new window













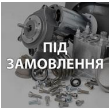













Натисніть - Ctrl + права кнопка миші щоб відкрити запчастину в новому вікні

	1		<b>184651500</b>	LOCKING SCREW ANTIDISTURB FILTER 16A <i>LOCKING SCREW ANTIDISTURB FILTER 16A</i>
	2		<b>U310.004</b>	NUT SELF LOCK.M6 UNI 7473 <i>NUT SELF LOCK.M6 UNI 7473</i>
	3		<b>U207.013</b>	PLAIN WASHER 6.5X18 UNI 6592 GALV <i>PLAIN WASHER 6.5X18 UNI 6592 GALV</i>
	4		<b>NE19.028</b>	TOROIDAL TRANSFORMER FS 400 <i>TRASFORMATORE TOROIDALE FS 400</i>
	5		<b>U111.008</b>	NICK.SCREW AUT.TSP 3,5X9,5 DIN7982 C <i>NICK.SCREW AUT.TSP 3,5X9,5 DIN 7982 C</i>
	6		<b>NE13.055</b>	CUP SOCKET 16A <i>CUP SOCKET 16A</i>
	7		<b>11008833</b>	POWER CONNECTOR SUPPORT <i>POWER CONNECTOR SUPPORT</i>
	8		<b>U110.003</b>	SCREW AUT.TCB 3,5X9,5 DIN 7981F <i>VITE AUT.TCB 3,5X9,5 DIN 798</i>
	9		<b>NE01.101</b>	CABLE SCHUKO 16A EN 60320 C19 <i>CABLE SCHUKO 16A EN 60320 C19</i>
	10		<b>11012105</b>	CABLE AUS + PLUG EN60320 C19 <i>CABLE AUS + PLUG EN60320 C19</i>
	10		<b>11012275</b>	CABLE RA + PLUG EN60320 C19 <i>CABLE RA + PLUG EN60320 C19</i>
	10		<b>11032544</b>	POWER CABLE BRA 16A 3X1,5 <i>POWER CABLE BRA 16A 3X1,5</i>
	11		<b>U302.007</b>	NUT HEXAGONAL M8 UNI 5588 <i>NUT HEXAGONAL M8 UNI 5588</i>

## Model Machine

MACSAE159

























ATLANTE 700 EVO

	12		<b>U208.009</b>	TOOTHED WASHER 8,4X15 UNI 3703 <i>TOOTHED WASHER 8,4X15 UNI 3703</i>
	13	 ПІД ЗАМОВЛЕННЯ	<b>11009894</b>	SAFETY PLATE FOR CONNECTOR <i>SAFETY PLATE FOR CONNECTOR</i>
	14	 ПІД ЗАМОВЛЕННЯ	<b>11008832</b>	CPU FOR TRASFORMER <i>CPU FOR TRASFORMER</i>
	15		<b>NE13.016</b>	FUSE HOLDER WITH SCREW ON CAP <i>PORTAFUSIBILE CON TAPPO A VITE</i>
	16	 ПІД ЗАМОВЛЕННЯ	<b>12001112</b>	FUSE 6,3X32 T 12A <i>FUSIBILE 6,3X32 T 12A</i>
	17	 ПІД ЗАМОВЛЕННЯ	<b>U005.013</b>	SCREW TE M6,0X70 UNI 5739 GALV. <i>SCREW TE M6,0X70 UNI 5739 GALV.</i>
	18		<b>NE13.091</b>	FUSE T 4A 6.3X32 <i>FUSIBILE T 4A 6.3X32 RITARDATO</i>
	19		<b>NE13.043</b>	FUSE 6,3X32 6,3A 250V DELAYED <i>FUSE 6,3X32 6,3A 250V DELAYED</i>
	20	 ПІД ЗАМОВЛЕННЯ	<b>11032237</b>	HARNESS ATL700 <i>CABLAGGIO MOBILE ATL700 UNIFICATO</i>
	21		<b>11008856</b>	SG650 POWER BOARD <i>SCHEDA POWER SG650</i>
	22		<b>11008857</b>	SG650 TRIAC BOARD <i>SCHEDA TRIAC SG 650</i>
	23		<b>9111.402</b>	SPACER FOR CARD <i>SPACER FOR CARD</i>
	24	 ПІД ЗАМОВЛЕННЯ	<b>0875.990</b>	TOUCH PANEL PLATE <i>TOUCH PANEL PLATE</i>
	25		<b>0875.741</b>	TOUCH PANEL <i>TOUCH PANEL</i>

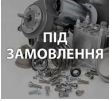
## Model Machine

MACSAE159





























ATLANTE 700 EVO

	26		<b>U116.005</b>	SCREW AUT.PT TCB 3,0X8 WN 1441 <i>VITE AUT.PT TCB 3,0X8 WN 1441 ZNP</i>
	27		<b>9991.140.050</b>	IMPULSE COUNTER HOLDER KEISU GX-06R <i>PORTA CONTAIMPULSI KEISU GX-</i>
	28		<b>NE13.025.00P</b>	IMPULSE COUNTER KEISU GX-06R 24V <i>CONTAIMPULSI KEISU GX-06R 24</i>
	29	 ПІД ЗАМОВЛЕННЯ	<b>11033901</b>	AS.CPU+SW ATLANTE UNICO <i>AS.CPU+SW ATLANTE UNICO</i>
	30	 ПІД ЗАМОВЛЕННЯ	<b>11009751</b>	26 POLES FLAT CABLE FOR PUSH BUTTON <i>26 POLES FLAT CABLE FOR PUSH BUTTON</i>
	31	 ПІД ЗАМОВЛЕННЯ	<b>U110.010</b>	SCREW AUT.TCB 2,9X6,5 DIN 7981F <i>VITE AUT.TCB 2.9X6.5 DIN 7981 F INOX</i>
	32		<b>11030270</b>	ATLANTE LED POWER SUPPLY <i>ATLANTE LED POWER SUPPLY</i>
	33	 ПІД ЗАМОВЛЕННЯ	<b>12001124</b>	RELAY FINDER 056.26 <i>RELAY FINDER 056.26</i>
	34	 ПІД ЗАМОВЛЕННЯ	<b>12001216</b>	SPACER RICHCO LCBS-3-01 <i>SPACER RICHCO LCBS-3-01</i>
	35	 ПІД ЗАМОВЛЕННЯ	<b>12001217</b>	SPACER RICHCO PS-3-01 <i>SPACER RICHCO PS-3-01</i>
	36		<b>U116.003</b>	SCREW AUT.PT TCB 3,0X12 WN 1441 <i>VITE AUT.PT TCB 3,0X12 WN 1441 ZNP</i>
	37		<b>11032436</b>	ТРИМАЧ ДИСПЛЕЮ <i>DISPLAY SUPPORT</i>
	38		<b>11032399</b>	3,5" TFT DISPLAY 320X240 <i>3,5 TFT DISPLAY 320X240</i>

## Model Machine

MACSAE159

ATLANTE 700 EVO











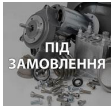

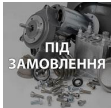

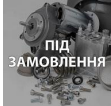

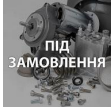

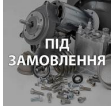

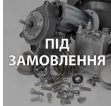

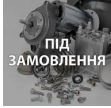



	39		11009750	24 POLES FLAT CABLE FOR DISPLAY <i>24 POLES FLAT CABLE FOR DISPLAY</i>
	40		U116.006	SCREW AUT.PT TCB 3,5X12 WN 1441 ZNP <i>VITE AUT.PT TCB 3,5X12 WN 1441 ZNP</i>
	41		11008817	INTERFACE BOARD FOR DISPLAY SG650 <i>SCHEDA INERFACCIA X DISPL. SG650</i>
	42		11032328	КНОПКА ДІСПЛЕЮ (-) ЧОРНА <i>PULSANTE DISPLAY (-) NERO</i>
	43		11032327	КНОПКА ДІСПЛЕЮ (+) ЧОРНА <i>PULSANTE DISPLAY (+) NERO</i>
	44		11032131	MEMBRANE KEYBOARD ATL700 ONE LED STRIP <i>MEMBRANE KEYBOARD ATL700 ONE LED STRIP</i>
	45		129670302	TCB PANELVIT SCREW 2,9X9,5 TES.D=7,5 ZNP <i>TCB PANELVIT SCREW 2,9X9,5 TES.D=7,5 ZNP</i>
	46		11031994	SG650 LED BOARD (ONE LED STRIPE) <i>SG650 LED BOARD (ONE LED STRIPE)</i>
	47		11032140	PUSH BUTTON <i>PUSH BUTTON</i>
	48		11009896	CARD PROTECTION SG650 <i>CARD PROTECTION SG650</i>
	49		11009897	CARD PROTECTION BOILER SG650 <i>CARD PROTECTION BOILER SG650</i>
	50		NF11.043	CLIP WITH HOOK <i>CLIP WITH HOOK</i>
	51		11012747	CARD PROTECTION LED ATLANTE <i>CARD PROTECTION LED ATLANTE</i>
	52		U109.011	SCREW AUT.TCB 3,9X9,5 DIN 7981C <i>SCREW AUT.TCB 3,9X9,5 DIN 7981 C</i>

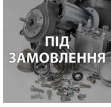

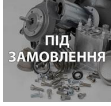
## Model Machine

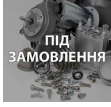
MACSAE159

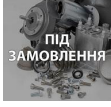









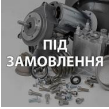

ATLANTE 700 EVO

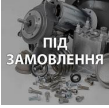
	53		11023437	ASS.LED SUPPORT ATLANTE <i>ASS.LED SUPPORT ATLANTE</i>
	54		NE13.099	CLAMP <i>CLAMP</i>
	55		2067.601	ADATTATORE INFRAROSSI <i>ADATTATORE INFRAROSSI</i>
	56		NE18.022	SPACER 4,2X8X7,5 PA 6-6 <i>SPACER RICHCO SS08-07.5 MM</i>
	57		11031252	IRDA CARD SUPPORT <i>IRDA CARD SUPPORT</i>
	58		U043.006	SCREW TCBC M4,0X14 UNI 7687 GALV. <i>SCREW TCBC M4,0X14 UNI 7687 GALV.</i>
	59		U324.003	NUT M5 FLANGED INDENTED BASE <i>NUT M5 FLANGED INDENTED BASE</i>
	60		NV01.007	РЕЗИНОВА НАКЛЕЙКА 1 ШТ <i>PIEDINO ADESIVO</i>
	61		NF11.047	NUT M4 H.4,5 IN PLASTIC <i>NUT IN PLASTIC</i>
	62		11031300	FLAT CABLE <i>FLAT CABLE</i>
	63		9991.206	MAGNET D.13 H.4,5 M5 MALE <i>MAGNET D.13 H.4,5 M5 MALE</i>
	64		11013811	ADHESIVE SUPPORT <i>SUPPORTO ADESIVO RIFLETTENTE BICCHIERE</i>
	65		11013812	SENSOR <i>SENSOR</i>
	66		U324.006	NUT M4 FLANGED INDENTED BASE <i>NUT M4 FLANGED INDENTED BASE</i>

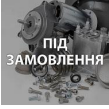
## Model Machine

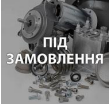
MACSAE159

ATLANTE 700 EVO

	67		11028020	SUPPORT SENSOR <i>SUPPORT SENSOR</i>
	68		129825502	TCB SCREW M4X25 UNI 7687 ZNP <i>TCB SCREW M4X25 UNI 7687 ZNP</i>
	69		11032179	ATLANTE LED CONNECTOR BOARD <i>ATLANTE LED CONNECTOR BOARD</i>
	70		1484.605	POWER RELAY 12A <i>POWER RELAY 12A</i>
	71		11031694	CARD ATLANTE CAPSULE EXPANSION <i>CARD ATLANTE CAPSULE EXPANSION</i>
	72		1034.802	FLAT CABLE 16 POLE L.250 <i>FLAT CABLE 16 POLE L.250</i>
	73		11032383	HW INTERF. NEW TFT DISPLAY UMSH-8252MD-T <i>SCHEDA INTERF. DISPLAY TFT UMS H-8252MD-T CRISTALLO400/600/PHE...</i>

# Model Machine

MACSAE159

ATLANTE 700 EVO

MACSAE159.T.0015

TAVOLA NR. 15 - ARTICOLO ATLANTE 700 EVO

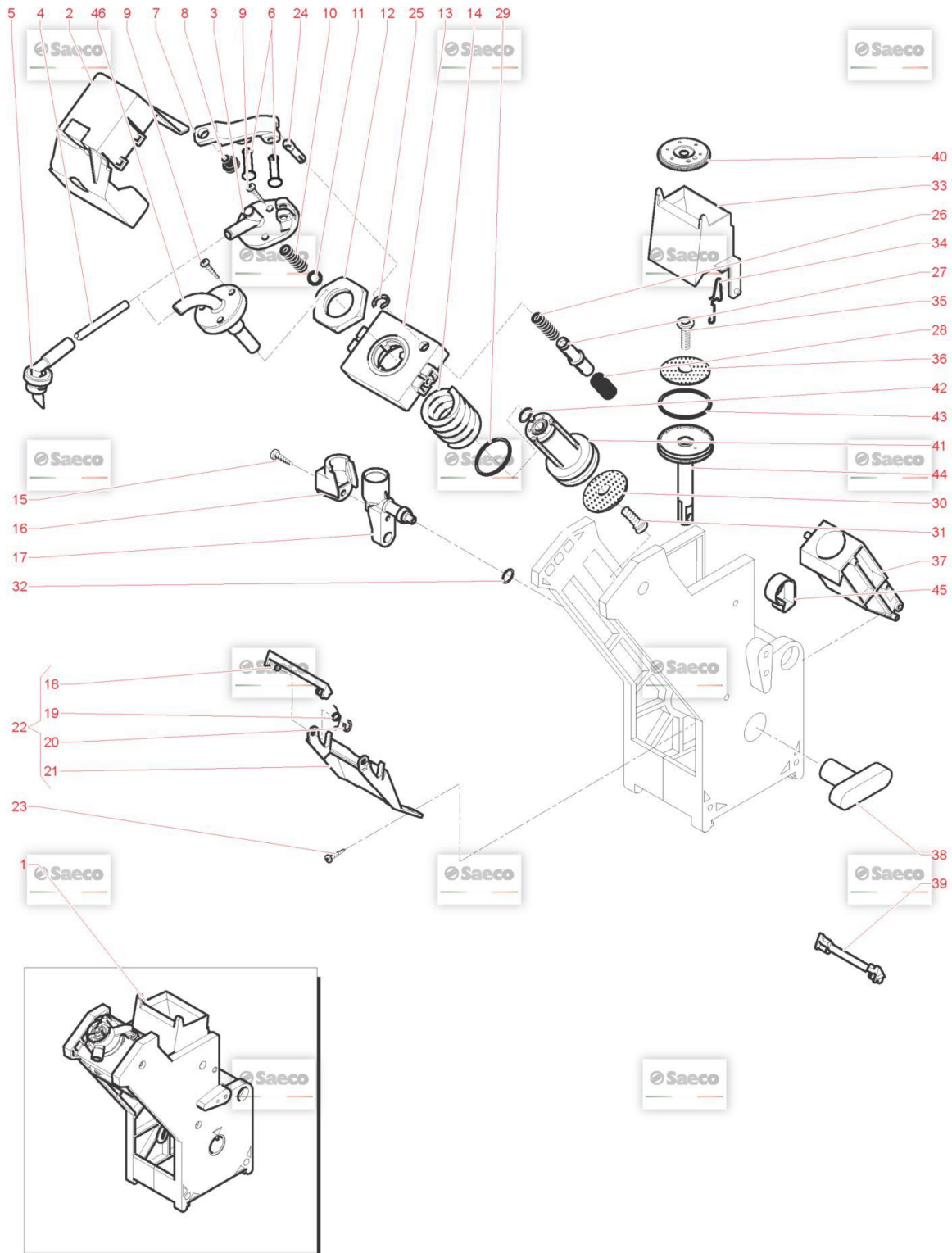

## Model Machine

MACSAE159

ATLANTE 700 EVO

Web Pos. Foto Item - Replace by Description



Press - CTRL + CLICK go to item in a new window

Натисніть - Ctrl + права кнопка миші щоб відкрити запчастину в новому вікні



1



11030408

BREWING UNIT ASS. 7GR GRAN GUSTO  
ASS. GRUPPO CAFFE 6/8GR NEW



1

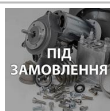

11031863

BREWING UNIT ASS. 7GR GUSTO  
COFFEE GROUP 6/8GR NEW



2



11029737

PROTECTION VALVE  
PROTEZIONE VALVOLA SFIATO GRUPPO CAFFE



3



11029311

COVER BALL VALVE  
COPERCHIO VALVOLA SFERA



4

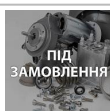

11032618

SILICONE TUBE 3,5X6 L=400 MM  
TUBO SILICONE 3.5X6 L=400 MM



4

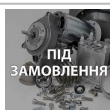

9972.345

SILICONE TUBE 3,5X9 L.340MM  
SILICONE TUBE 3,5X9 L.340MM



5

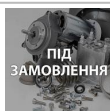

11033574

COFFEE NOZZLES  
COFFEE NOZZLES



6



11030836

PIN FIXING VALVE SUPPORT  
PIN FIXING VALVE SUPPORT



7



11029312

BREATHER VALVE CLOSED  
CHIUSURA VALVOLA SFIATO



8



NV01.009

RUBBER BUFFER  
GOMMINO PARACOLPI



9

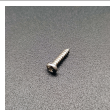

U109.006

SCREW AUT.TCB 2,2X9,5 DIN 7981C  
VITE AUT.TCB 2,2X9,5 DIN 7981 C NIK



10



126771918

SS COFFEE UNIT CONTERPISTON SPRING SMART  
MOLLA CONTROPIST. GRUP. SMART INOX



11



















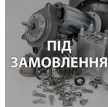









12001811

SPHERE TEFLON D.4,5  
SFETA D.4.5 TEFLON X VALVOLA GRUPPO CAFF

## Model Machine

MACSAE159

























ATLANTE 700 EVO

	12		<b>11029317</b>	NUT SEAL PISTON MOVABLE <i>DADO TENUTA CONTROPISTONE MOBILE</i>
	13		<b>11029316</b>	FLANGE FOR CUPHOLDER <i>FLANGIA X PISTONE MOBILE</i>
	14		<b>11029308</b>	SPRING FOR MOVABLE COUNTERPISTON <i>MOLLA X CONTROPISTONE MOBILE</i>
	14		<b>11032172</b>	SPRING FOR COUNTERPISTON 4,5 L.38,5 <i>SPRING FOR COUNTERPISTON 4,5 L.38,5</i>
	15		<b>129512921</b>	SCREW TCB TORX 10 AB 2,9X13 SHEET SS <i>SCREW TCB TORX 10 2,9X13 SHEET SS</i>
	16		<b>11010013</b>	CARTER FOR MUFF PREHEATING UNIT <i>CARTE X MANICOTTO GRUPPO PRERISCALDO</i>
	17		<b>11005371</b>	UNIT COFFEE MUFF <i>MANICOTTO GRUPPO CAFFE' UNIT COFFEE MUFF</i>
	18		<b>9111.537.060</b>	BROWN SCRAPER COFFEE GROUP <i>BROWN SCRAPER COFFEE GROUP</i>
	19		<b>9111.520</b>	SPRING FOR SCRAPER SECTION 0.6 <i>SPRING FOR SCRAPER SECTION 0.6</i>
	20		<b>U701.006</b>	SNAP RING 3,2 UNI 7434 <i>ANELLO ELASTICO 3,2</i>
	21		<b>9111.539.060</b>	FORK FOR SCRAPER <i>FORCELLA PER RASCHIATORE</i>
	22		<b>9110.067.060</b>	SCRAPER ASS.FOR CAPPUCCIAT. TUBE <i>ASS.RASCHIATORE X SG500/700</i>
	23		<b>U110.013</b>	SCREW AUT.TCB 3,9X6,5 DIN 7981F <i>SCREW AUT.TCB 3,9X6,5 DIN 7981 F</i>
	24		<b>11029313</b>	CURSOR COMPENSATOR VALVE VENT <i>CURSORE COMPENSATORE X VALVOLA SFIATO</i>

## Model Machine

MACSAE159

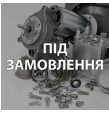











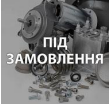

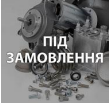



ATLANTE 700 EVO

	25		U701.007	SNAP RING 6 UNI 7434 <i>ЕЛАСТИЧНЕ КИЛЬЦЕ 6 UNI 7434 (ЗАЛІЗО)</i>
	26		11029310	SPRING FOR RELIEF VALVE <i>MOLLA COMPENSATRICE X VALVOLA SFIATO</i>
	27		11029314	CURSOR FOR VALVE VENT <i>CURSORE X VALVOLA SFIATO</i>
	28		11029309	SPRING FOR RELIEF VALVE <i>MOLLA X VALVOLA SFIATO</i>
	29		140322061	O-RING 4112 EPDM <i>OR 4112 IN EPDM</i>
	30		11012630	PERCOLATOR D.34 <i>PERCOLATOR D.34</i>
	31		U044.009	SS SCREW TSPC M3,0X8 UNI 7688 <i>VITE TSCP M3,0X8 UNI 7688 INO</i>
	32		140321462	O-RING 2018 SILICONE <i>OR 2018 IN SILICONE</i>
	33		322001201	MOBILE SCRAPER BROWN NARROW <i>MOBILE SCRAPER BROWN NARROW</i>
	34		9161.425	SPRING FOR SCRAPER <i>SPRING FOR SCRAPER</i>
	35		129851921	TSP SCREW M3X6 UNI 7688 SS <i>TSP SCREW M3X6 UNI 7688 SS</i>
	36		324000200	SS PERCOLATOR D=34 FOR UNIT <i>SS PERCOLATOR D=34 FOR UNIT</i>
	37		222711101	BROWN GROUND COFF.CONTAINER D=36 ASSY. <i>BROWN GROUND COFF.CONTAINER D=36 ASSY.</i>

## Model Machine

MACSAE159

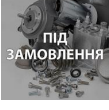
ATLANTE 700 EVO

	38		9161.021.060	KEY FOR BREW UNIT BROWN <i>CHIAVE X GRUPPO CAFFE' MARRO</i>
	39		11012957	SCRAPER FOR COFFEE UNIT 7-9GR. <i>SCRAPER FOR COFFEE UNIT 7-9GR.</i>
	40		11030122	SPACE <i>SPACE</i>
	41		11029878	ASS.CONTROPISTONE MOBILE <i>ASS.CONTROPISTONE MOBILE</i>
	42		NM01.029	OR ORM 0100-15 SILICONE <i>OR ORM 0100-15 SILICONE</i>
	43		140322500	ПРОКЛАДКА O-RING 2118 SH70 BIANCHI 36363116-01, SAECO 140322500 <i>OR 2118 IN NITRIL RUBBER</i>
	44		11029879	ASS.PISTONE X GRUPPO CAFFE' <i>ASS.PISTONE X GRUPPO CAFFE'</i>
	45		11030309	RING FOR CAM <i>ANELLO X CAMMA PISTONE</i>
	46		11031800	COVER GROUP IVS CONTROPISTONE <i>COVER GROUP IVS CONTROPISTONE</i>
	47		9161.320	VALVE FOR UNIT <i>VALVOLA X GRUPPO CAFFE'</i>

# Model Machine

MACSAE159

ATLANTE 700 EVO

MACSAE159.T.0016

TAVOLA NR. 16 - ARTICOLO ATLANTE 700 EVO

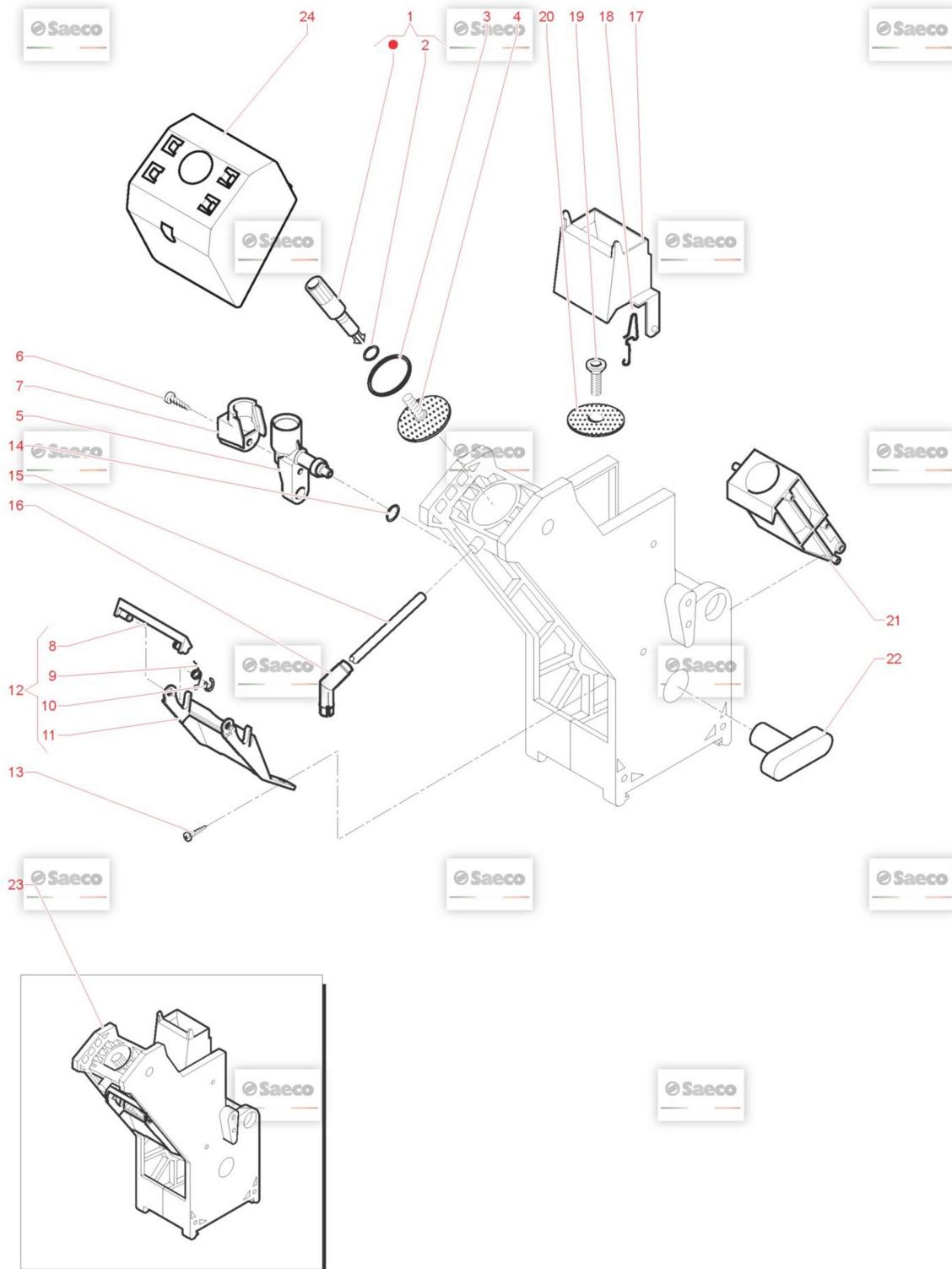





























## Model Machine

MACSAE159























ATLANTE 700 EVO

Web	Pos.	Foto	Item - Replace by	Description
				<i>Press - CTRL + CLICK go to item in a new window Натисніть - Ctrl + права кнопка миші щоб відкрити запчастину в новому вікні</i>
	1		9169.A14.150	PIN FOR PERCOLATOR GREY ASS.PERNO X DOCCIA COMPLETO GRIGIO
	2		NM02.006	OR R5 TERMOIL OR R5 EPDM
	3		NM01.044	OR ORM 0320-40 SILICONE PTFE/FDA OR ORM 0320-40 SILICONE PTFE
	4		9161.036	UPPER PERCOLATOR FOR UNIT DOCCIA SUPERIORE X GRUPPO
	5		11005371	UNIT COFFEE MUFF MANICOTTO GRUPPO CAFFE' UNIT COFFEE MUFF
	6		129512921	SCREW TCB TORX 10 AB 2,9X13 SHEET SS SCREW TCB TORX 10 2,9X13 SHEET SS
	7		11010013	CARTER FOR MUFF PREHEATING UNIT CARTE X MANICOTTO GRUPPO PRERISCALDO
	8		9111.537.150	GREY SCRAPER COFFEE GROUP GREY SCRAPER COFFEE GROUP
	9		9111.520	SPRING FOR SCRAPER SECTION 0.6 SPRING FOR SCRAPER SECTION 0.6
	10		U701.006	SNAP RING 3,2 UNI 7434 ANELLO ELASTICO 3,2
	11		9111.539.150	FORK FOR SCRAPER FORCELLA PER RASCHIATORE
	12		9110.067.150	SCRAPER ASS.FOR CAPPUCCINAT. TUBE ASS.RASCHIATORE X SG500/700
	13		U110.013	SCREW AUT.TCB 3,9X6,5 DIN 7981F SCREW AUT.TCB 3,9X6,5 DIN 7981 F

## Model Machine

MACSAE159

ATLANTE 700 EVO

	14		140321462	O-RING 2018 SILICONE <i>OR 2018 IN SILICONE</i>
	15		9972.057	SILICONE TUBE 5X8 L.2000MM <i>TUBO SILICONE MARRON 5X8 L.2000 MM</i>
	16		9111.349	ELBOW DISPENSING NOZZLE <i>UGELLO EROGAZIONE GOMITO</i>
	17		322001259	ПЛАСТИКОВА ВОРНОКА ПОДАЧИ КАВИ (ПЛАСТИК) ЧОРНИЙ <i>MOBILE SCRAPER GREY NARROW</i>
	18		9161.425	SPRING FOR SCRAPER <i>SPRING FOR SCRAPER</i>
	19		129851921	TSP SCREW M3X6 UNI 7688 SS <i>TSP SCREW M3X6 UNI 7688 SS</i>
	20		9161.037	LOWER PERCOLATOR FOR UNIT <i>DOCCIA INFERIORE X GRUPPO</i>
	21		11002626	ASS. COFFEE CONTAINER GREY 9 GR. <i>ASS. COFFEE CONTAINER GREY 9 GR.</i>
	22		9161.021.060	KEY FOR BREW UNIT BROWN <i>CHIAVE X GRUPPO CAFFE' MARRO</i>
	23		11005422	BREW UNIT 9 GRAMS <i>GRUPPO CAFFE' 9GR CRISTALLO 600</i>
	24		11013053	CARTER FOR DOSER UNIT <i>CARTER FOR DOSER UNIT</i>

# Model Machine

MACSAE159

ATLANTE 700 EVO

MACSAE159.T.0017



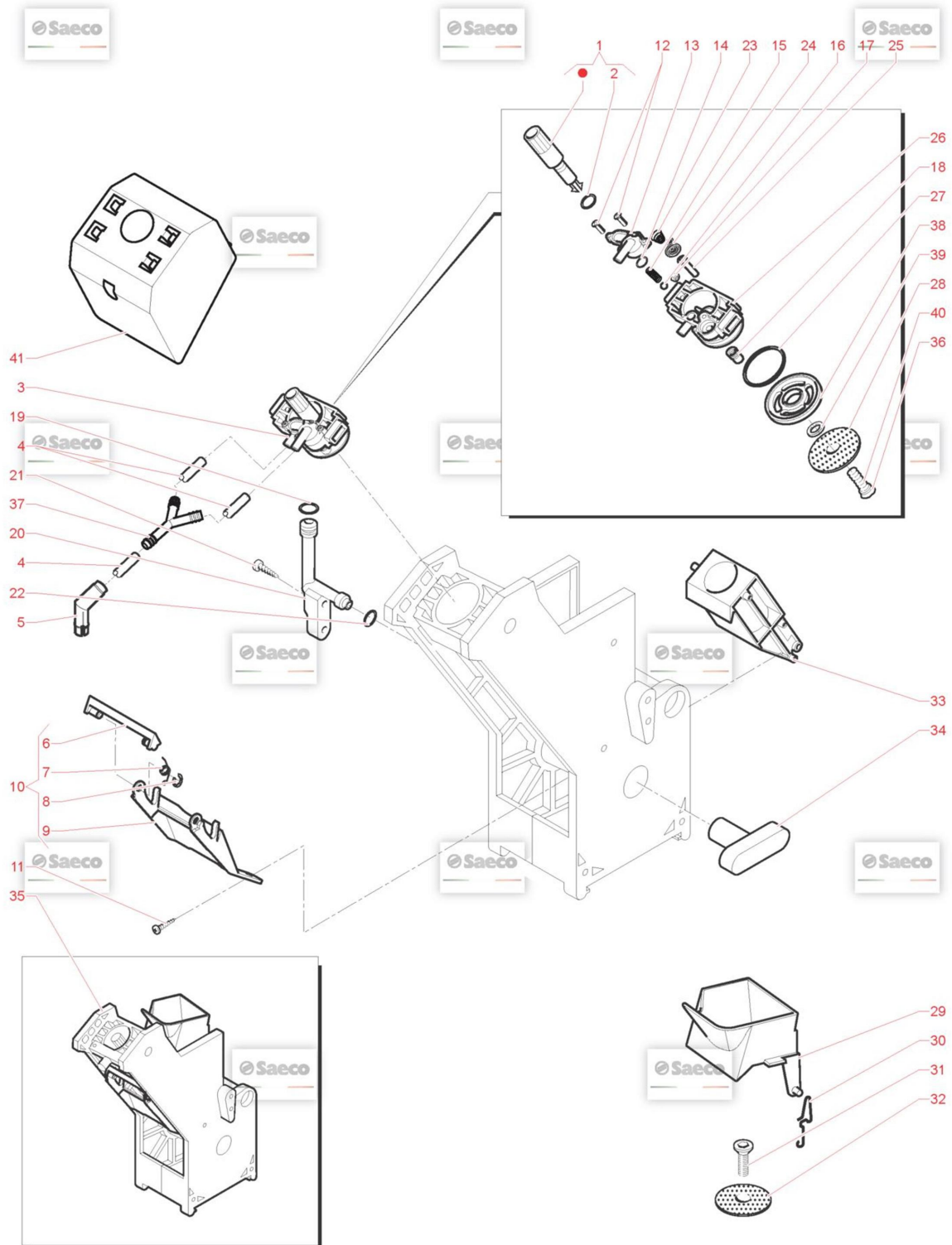























TAVOLA NR. 17 - ARTICOLO ATLANTE 700 EVO



## Model Machine

MACSAE159

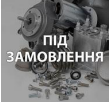









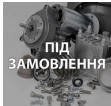

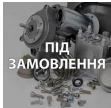





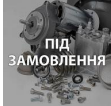



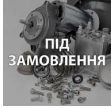



ATLANTE 700 EVO

Web	Pos.	Foto	Item - Replace by	Description
				<i>Press - CTRL + CLICK go to item in a new window Натисніть - Ctrl + права кнопка миші щоб відкрити запчастину в новому вікні</i>
	1		9169.A14.150	PIN FOR PERCOLATOR GREY ASS.PERNO X DOCCIA COMPLETO GRIGIO
	2		NM02.006	OR R5 TERMOIL OR R5 EPDM
	3		11032455	COUNTER PISTON COUNTER PISTON
	4		9972.057	SILICONE TUBE 5X8 L.2000MM TUBO SILICONE MARRON 5X8 L.2000 MM
	5		9111.349	ELBOW DISPENSING NOZZLE UGELLO EROGAZIONE GOMITO
	6		9111.537.150	GREY SCRAPER COFFEE GROUP GREY SCRAPER COFFEE GROUP
	7		9111.520	SPRING FOR SCRAPER SECTION 0.6 SPRING FOR SCRAPER SECTION 0.6
	8		U701.006	SNAP RING 3,2 UNI 7434 ANELLO ELASTICO 3,2
	9		9111.539.150	FORK FOR SCRAPER FORCELLA PER RASCHIATORE
	10		9110.067.150	SCRAPER ASS.FOR CAPPUCCINAT. TUBE ASS.RASCHIATORE X SG500/700
	11		U110.013	SCREW AUT.TCB 3,9X6,5 DIN 7981F SCREW AUT.TCB 3,9X6,5 DIN 7981 F
	12		U109.030	SCREW AUT.TCB 2,9X16 DIN 7981C SCREW AUT.TCB 2,9X16 DIN 7981 C
	13		11003470	КРИШКА НОСИКА LID X COUNTERPISTON FRESH-BREW

## Model Machine

MACSAE159

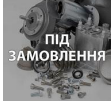









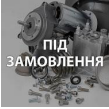











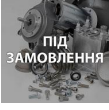

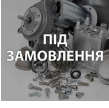
ATLANTE 700 EVO

	14		<b>NM02.013</b>	OR ORM 0080-15 TERMOIL <i>OR ORM 0080-15 TERMOIL</i>
	15		<b>11007470</b>	SPRING FOR FS400 COVER CHASSIS <i>SPRING FOR FS400 COVER CHASSIS</i>
	16		<b>12001650</b>	SPHERE TEFLON D.5 <i>SPHERE TEFLON D.5</i>
	17		<b>U302.003</b>	GALV.NUT HEXAGONAL M4 UNI 5589ZN <i>DADO ESAGONALE M4 UNI 5588 ZNP</i>
	18		<b>11003472</b>	RUBBER X UNIT FRESH-BREW <i>RUBBER X UNIT FRESH-BREW</i>
	19		<b>140320461</b>	OR ORM 0080-20 TERMOIL <i>OR ORM 0080-20 IN TERMOIL</i>
	20		<b>322000559</b>	WATER FLOW PISTON GREY <i>WATER FLOW PISTON GREY</i>
	21		<b>129512921</b>	SCREW TCB TORX 10 AB 2,9X13 SHEET SS <i>SCREW TCB TORX 10 2,9X13 SHEET SS</i>
	22		<b>140321462</b>	O-RING 2018 SILICONE <i>OR 2018 IN SILICONE</i>
	23		<b>11002603</b>	SPING FOR MEMBRANE <i>SPING FOR MEMBRANE</i>
	24		<b>11002625</b>	MEMBRANE <i>MEMBRANE</i>
	25		<b>11003471</b>	PIN FOR MEMBRANE FRESH-BREW <i>PIN FOR MEMBRANE FRESH-BREW</i>
	26		<b>11003469</b>	COUNTERPISTON FRESH-BREW <i>COUNTERPISTON FRESH-BREW</i>
	27		<b>NM01.044</b>	OR ORM 0320-40 SILICONE PTFE/FDA <i>OR ORM 0320-40 SILICONE PTFE</i>

## Model Machine

MACSAE159

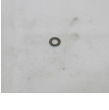
ATLANTE 700 EVO

	28		11031174	UPPER PERCOLATOR FOR UNIT D.36 <i>UPPER PERCOLATOR FOR UNIT D.36</i>
	29		11003529	HOPPER DOSER UNIT FRESH BREW <i>HOPPER DOSER UNIT FRESH BREW</i>
	30		126836618	SPRING H=28 NEW FOR SCRAPER <i>MOLLA H=28 NEW X RASCHIATORE</i>
	31		129851921	TSP SCREW M3X6 UNI 7688 SS <i>TSP SCREW M3X6 UNI 7688 SS</i>
	32		9161.037	LOWER PERCOLATOR FOR UNIT <i>DOCCIA INFERIORE X GRUPPO</i>
	33		11002626	ASS. COFFEE CONTAINER GREY 9 GR. <i>ASS. COFFEE CONTAINER GREY 9 GR.</i>
	34		9161.021.150	KEY FOR BREW UNIT GREY <i>KEY FOR BREW UNIT GREY</i>
	35		11031899	BREW UNIT 6,5GRAMS FRESH BREW <i>BREW UNIT 6,5GRAMS FRESH BREW AUTOBAR</i>
	36		129852821	TSP SCREW M3X14 UNI 7688 SS <i>TSP SCREW M3X14 UNI 7688 SS</i>
	37		147920800	Y CONNECTOR D=8 ART.80.26.048KA.466 <i>RACCORDO Y D=8 ART.80.26.048 KA.466</i>
	38		11031839	SPACER FOR DOSER UNIT FRESH BREW <i>SPACER FOR DOSER UNIT FRESH BREW</i>
	39		U207.003	PLAIN WASHER 3,2X7 UNI 6592 GALV. <i>PLAIN WASHER 3,2X7 UNI 6592 GALV.</i>
	40		U044.021	SCREW TSP M3,0X20 UNI 7688 SS <i>SCREW TSP M3,0X20 UNI 7688 SS</i>

## Model Machine

MACSAE159

ATLANTE 700 EVO



41



11013053

CARTER FOR DOSER UNIT

*CARTER FOR DOSER UNIT*

---

# Model Machine

MACSAE159

ATLANTE 700 EVO

MACSAE159.T.0018

TAVOLA NR. 18 - ARTICOLO ATLANTE 700 EVO

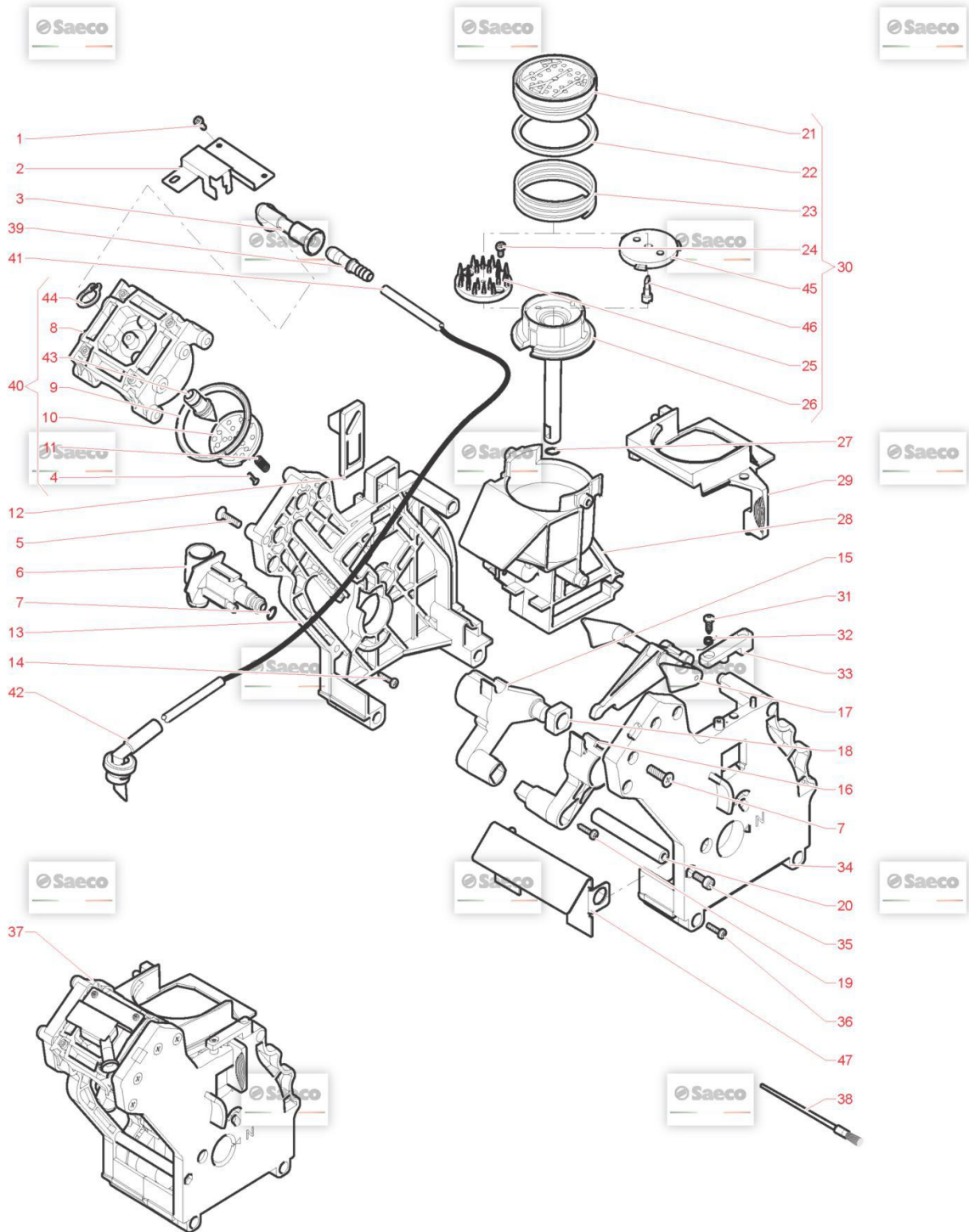



## Model Machine

MACSAE159

ATLANTE 700 EVO

Web Pos. Foto Item - Replace by Description



Press - CTRL + CLICK go to item in a new window  
Натисніть - Ctrl + права кнопка миші щоб відкрити запчастину в новому вікні



1



129512921

SCREW TCB TORX 10 AB 2,9X13 SHEET SS  
SCREW TCB TORX 10 2,9X13 SHEET SS



2

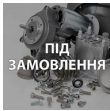

11031906

PLATE  
PLATE



3

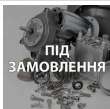

11004586

BLK COFFEE OUTLET CONVEYOR OCS  
BLK COFFEE OUTLET CONVEYOR OCS



3

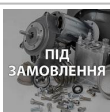

9161.356

BLK COFFEE OUTLET CONVEYOR LAV.  
BLK COFFEE OUTLET CONVEYOR LAV.



4

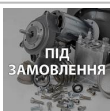

129912621

SCREW PT KB 30X8 WN 1413 INOXA2  
SCREW PT KB 30X8 WN 1413 INOX A2



5

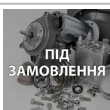

129911721

SCREW TSP TORX 4X16 PLAST STEEL  
SCREW TSP TORX 4X16 PLAST STEEL



6



9161.064.150

ВХІДНИЙ КЛАПАН ЗАВАРЮВАЛЬНОГО БЛОКУ КАВОВАРКИ SAECO ПРО...  
MANICOTTO ENTRATA ACQUA GRUP.CAF.GRIGIO CON OR NM02.007 - F...



7



NM02.007

OR 2025 IN TERMOIL  
OR 2025 TERMOIL



8

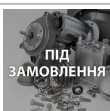

11013418

BLK COFF.CAPSULE FIXED CONTAINER V3 LAV.  
BLK COFF.CAPSULE FIXED CONTAINER V3 LAV.



8

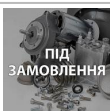

11034351

BLK COFF.CAPSULE FIXED CONTAINER  
CONT.FISSO CAPS LAVORATO CO BLK



8

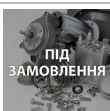

421941306941

CONT.FISSO CAPS.CAF.ATL700 CAGRI.  
GREY COFFEE CAPS.FIXED CONTAINER ATL700



9



11031760

SEAL FOR BREW UNIT CAPS  
SEAL FOR BREW UNIT CAPS



9

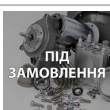











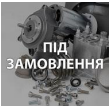

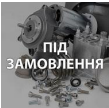













421941306911

SEAL FOR BREW UNIT CAPS CA  
SEAL FOR BREW UNIT CAPS CA

## Model Machine

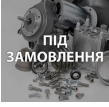
MACSAE159

















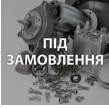





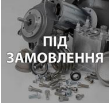

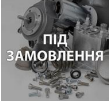
ATLANTE 700 EVO

	10		<b>11031226</b>	PIERCER GROUP CAPS <i>PIERCER GROUP CAPS</i>
	11		<b>126773518</b>	SS SPRING FOR COFFEE CAPSULE LAV. <i>SS SPRING FOR COFFEE CAPSULE LAV.</i>
	11		<b>421941306921</b>	SPRING FOR STEEL PIERCE BU CAPSULE CA <i>MOLLA X FORATORE CA</i>
	12		<b>9161.373.150</b>	GREY BREW UNIT COUPLING PLATESMART <i>GREY BREW UNIT COUPLING PLATE SMART</i>
	13		<b>11013396</b>	BLACK BREW UNIT REAR PLATE V3LAV. <i>BLACK BREW UNIT REAR PLATE V3 LAV.</i>
	14		<b>12000550</b>	CAMOPI3 TCB TORX 10 3X25 PLAST.SS <i>SCREW TCB TORX 10 3X25 PLAST.SS</i>
	15		<b>120080722</b>	ALUM.FEMALE ELBOW SHAFT <i>ALUM.FEMALE ELBOW SHAFT</i>
	16		<b>120080622</b>	ALUM.MALE ELBOW SHAFT <i>ALUM.MALE ELBOW SHAFT</i>
	17		<b>11032146</b>	GREY BREW UNIT CONNECTING RODCAPS <i>GREY BREW UNIT CONNECTING ROD CAPS</i>
	18		<b>9161.094.050</b>	BLACK BREW UNIT DRILLED BLOCK <i>BLACK BREW UNIT DRILLED BLOCK</i>
	19		<b>129574421</b>	SCREW TCB PH/TT 4X20 UNI 8112ST.ST <i>SCREW TCB PH/TT 4X20 UNI 8112 ST.ST</i>
	20		<b>9161.298</b>	BRASS SPACER <i>BRASS SPACER</i>
	21		<b>11011770</b>	CASING TO MOVABLE DRILLING PLATE V3 LAV. <i>CORPO A PIATTEL.MOBILE FORATO V3 LAV.NER</i>
	21		<b>142906059</b>	CASING TO MOVABLE DRILLING PLATE <i>CASING TO MOVABLE DRILLING PLATE</i>

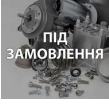
## Model Machine

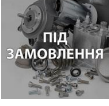
MACSAE159

















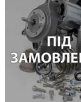









ATLANTE 700 EVO

	22		<b>11026624</b>	LIP SEAL FOR CAPS.EXPELLER PISTON V4 LAV <i>LIP SEAL FOR CAPS.EXPELLER PISTON V4 LAV</i>
	22		<b>145855700</b>	LIP SEAL FOR EXPELLER PISTON OCS <i>LIP SEAL FOR EXPELLER PISTON OCS</i>
	23		<b>126772418</b>	COFF.CAPSULE EXPELLER PISTON SPRING LAV. <i>COFF.CAPSULE EXPELLER PISTON SPRING LAV.</i>
	23		<b>126774118</b>	SPIRAL SPRING FOR PISTON EXPELLER <i>SPIRAL SPRING FOR PISTON EXPELLER</i>
	24		<b>129910921</b>	SCREW TCB TORX 10 3X10 SS <i>SCREW TCB TORX 10 3X10 SS</i>
	25		<b>149198000</b>	COFFEE CAPS.LOWER DRILLING SUPPORT LAV. <i>COFFEE CAPS.LOWER DRILLING SUPPORT LAV.</i>
	26		<b>229211859</b>	COFFEE CAPSULE EXPELLER PISTONLAV. <i>COFFEE CAPSULE EXPELLER PISTON LAV.</i>
	26		<b>229211959</b>	COFFEE CAPSULE EXPELLER PISTONOCS <i>COFFEE CAPSULE EXPELLER PISTON OCS</i>
	27		<b>NM02.018</b>	OR ORM 0090-25 TERMOIL <i>OR ORM 0090-25 TERMOIL</i>
	28		<b>421941306881</b>	MOBILE CONT. BU CAPS V3 ATL 700 ASSY <i>MOBILE CONT. BU CAPS V3 ATL 700 ASSY</i>
	28		<b>421941306901</b>	MOBILE CONTAINER BU OCS CAPS ATL700 ASSY <i>ASS.CONT.MOBILE GRUPPO CAPS ATL700 GRY</i>
	29		<b>11031018</b>	HOPPER COFFEE GROUP <i>HOPPER COFFEE GROUP</i>
	30		<b>11026626</b>	PISTON EXPELLER COFFEE CAPSULEV4 ASSY. <i>PISTON EXPELLER COFFEE CAPSULE V4 ASSY.</i>

## Model Machine

MACSAE159

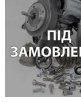













ATLANTE 700 EVO

	30		<b>227661000</b>	PISTON AS.EXPELLER COFF.CAPSULE OCS ASSY <i>PISTON AS.EXPELLER COFF.CAPSULE OCS ASSY</i>
	31		<b>12000895</b>	SCREW TSP TORX 10 3X10 PLAST.SS <i>SCREW TSP TORX 10 3X10 PLAST.SS</i>
	32		<b>9161.378</b>	SS HOPPER SPRING FOR BREW UNITSMART <i>SS HOPPER SPRING FOR BREW UNIT SMART</i>
	33	 ПІД ЗАМОВЛЕННЯ	<b>9161.374.150</b>	GRY BREWUNIT HOPPER BLOCKING PLATE SMART <i>GRY BREWUNIT HOPPER BLOCKING PLATE SMART</i>
	34	 ПІД ЗАМОВЛЕННЯ	<b>11014199</b>	BLK BREW UNIT FRONT PLATE V3 S/SCR.LAV. <i>BLK BREW UNIT FRONT PLATE V3 S/SCR.LAV.</i>
	35	 ПІД ЗАМОВЛЕННЯ	<b>U023.011</b>	SCREW TCEI M4,0X10 UNI 5931 SSA <i>SCREW TCEI M4,0X10 UNI 5931 SS A</i>
	36	 ПІД ЗАМОВЛЕННЯ	<b>12000897</b>	SCREW TCB TORX 10 3,5X20 PLAST.SS <i>SCREW TCB TORX 10 3,5X20 PLAST.SS</i>
	37		<b>11031702</b>	РОБОЧА ГРУПА V4 BLK SAECO ATLANTE, CRISTALLLO <i>COFFEE GROUP V4 ATLANTE CAPS BLK</i>
	37	 ПІД ЗАМОВЛЕННЯ	<b>11032374</b>	BLACK BREW UNIT V2 CAP CA <i>BLACK BREW UNIT V2 ATLANTE CAPS CA</i>
	37	 ПІД ЗАМОВЛЕННЯ	<b>11034353</b>	BREW UNIT CAPS CO <i>BREW UNIT CAPS CO</i>
	39	 ПІД ЗАМОВЛЕННЯ	<b>1040.028.050</b>	STD TOOTHED CONNECT. F3/8X09 <i>STD TOOTHED CONNECT. F3/8X09</i>
	40	 ПІД ЗАМОВЛЕННЯ	<b>11031829</b>	COFF.CAPSULE FIXED CONT.V3 ATL700 ASSY. <i>COFF.CAPSULE FIXED CONT.V3 ATL700 ASSY.</i>
	40	 ПІД ЗАМОВЛЕННЯ	<b>11034352</b>	CAPSULE FIXED CONT. CO ASSY. <i>CAPSULE FIXED CONT. CO ASSY.</i>
	40	 ПІД ЗАМОВЛЕННЯ	<b>11034993</b>	CAPSULE FIXED CONT. CA ASSY. <i>ASS.CONT.FISSO CAPS CA</i>

## Model Machine

MACSAE159

ATLANTE 700 EVO

	41		11032617	SILICONE TUBE 3,5X6 L=285 MM <i>TUBO SILICONE 3.5X6 L=285 MM</i>
	42		11031990	NOZZLE <i>NOZZLE</i>
	43		421941306931	STAINLESS STEEL PIERCER OUTLET COFFEE CA <i>CORPO FORATORE CA USCITA CAFFE' OCS INOX</i>
	44		120340421	ELAST.SHAFT RETAIN.RING D=5 UNI7435 <i>ELAST.SHAFT RETAIN.RING D=5 UNI7435</i>
	45		149203000	LOWER COFF.CAPSULE DRILLING SUPPORT OCS <i>LOWER COFF.CAPSULE DRILLING SUPPORT OCS</i>
	46		122908721	STAINLESS STEEL PIERCER INLET WATER OCS <i>STAINLESS STEEL PIERCER INLET WATER OCS</i>
	47		11032349	ANTI-OVERTURNING PLATE <i>ANTI-OVERTURNING PLATE</i>

# Model Machine

MACSAE159

ATLANTE 700 EVO

MACSAE159.T.0019

TAVOLA NR. 19 - ARTICOLO ATLANTE 700 EVO

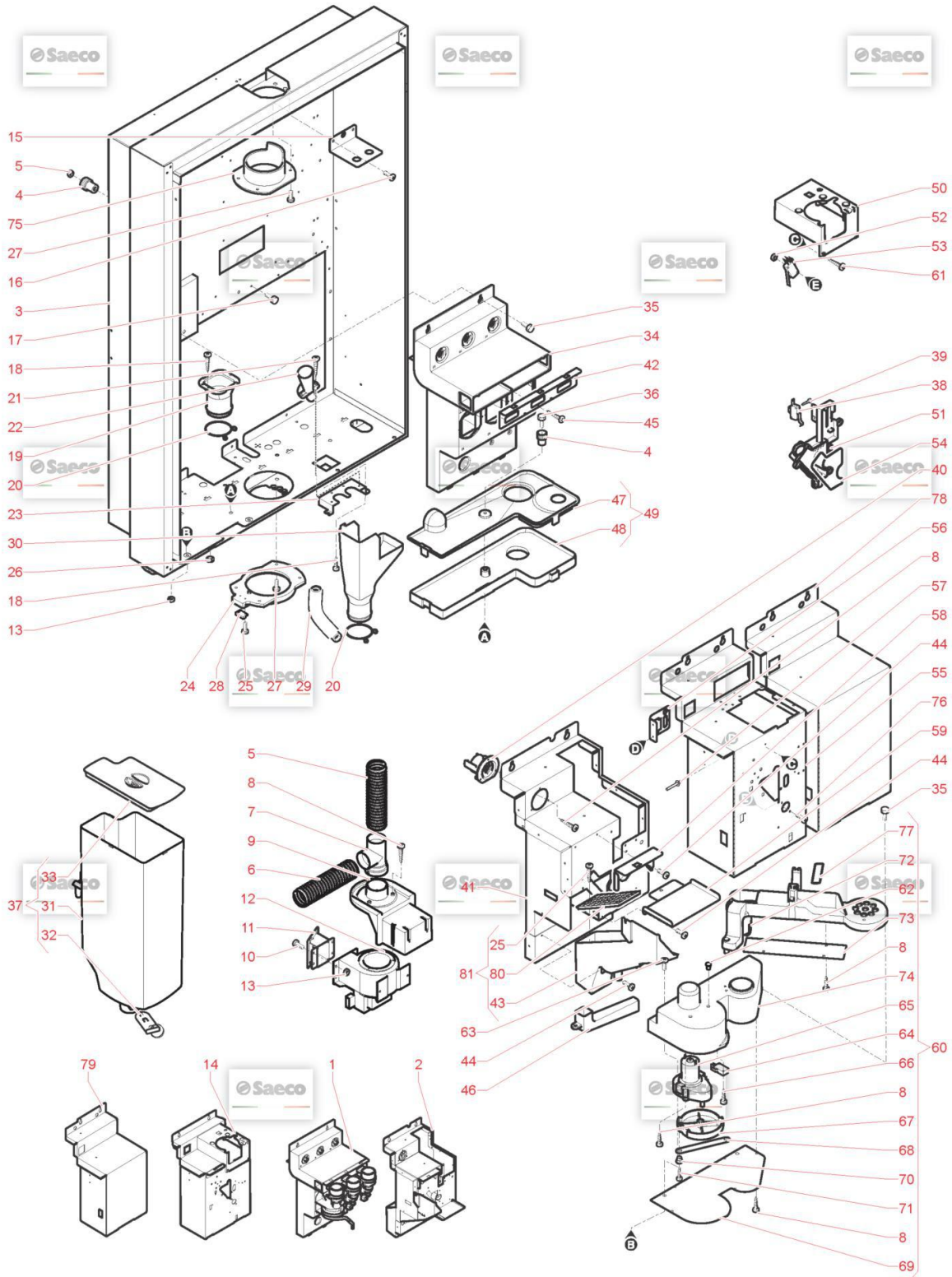

## Model Machine

MACSAE159

ATLANTE 700 EVO

Web Pos. Foto Item - Replace by Description



Press - CTRL + CLICK go to item in a new window

Натисніть - Ctrl + права кнопка миші щоб відкрити запчастину в новому вікні



1

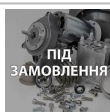

11008243

ASS. MODULE 3 MOTOR  
ASS. MODULE 3 MOTOR



2

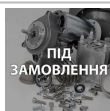

11033218

MOTOR MODULE CAPS  
MOTOR MODULE CAPS



3

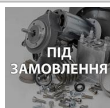

11032480

REVOLVING PLATE SKIN ATL700  
REVOLVING PLATE SKIN ATL700



4



9111.307.270

STIRRER PLATE KNOB 8P  
POMELLO PIASTRA PALETTE 8P



5



123160502

GALVANIZED NUT M5 HIGH UNI 5587-68  
GALVANIZED NUT M5 HIGH UNI 5587-68



6



0894.009

SPIRAL TUBE D.32 L=280 MM  
SPIRAL TUBE D.32 L=760 MM



7



9111.640.060

TUBE CONNECTOR  
TUBE CONNECTOR



8



U116.006

SCREW AUT.PT TCB 3,5X12 WN 1441 ZNP  
VITE AUT.PT TCB 3,5X12 WN 1441 ZNP



9

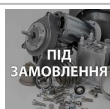

9111.732.A20

SUPPORT  
SUPPORT



10



U043.015

SCREW TCBC M5,0X12 UNI 7687 GALV.  
SCREW TCBC M5,0X12 UNI 7687 GALV.



11



11009123

ASS.CHANNEL FAN ASPIRATION  
ASS.CHANNEL FAN ASPIRATION



12



9121.198.00A

ВЕНТИЛЯТОР ВИТЯЖКИ 07 120X100X100 SAECO 9121.198.00A  
VENTILATORE CENTRIFUGO CAP 07



13

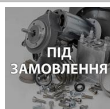













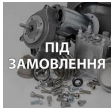



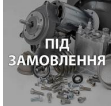

U324.003

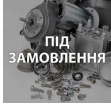
NUT M5 FLANGED INDENTED BASE  
NUT M5 FLANGED INDENTED BASE

## Model Machine

MACSAE159

ATLANTE 700 EVO























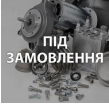

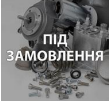
	14		<b>11031058</b>	ASS. MODULE COFFEE 1 GRIND CAPS ASS. MODULE COFFEE 1 GRIND CAPS
	15		<b>11009909</b>	SUPPORT COFFEE CONTAINER SG650 SUPPORT COFFEE CONTAINER SG650
	16		<b>U127.011</b>	SCREW TAPT.TCB M5,0X8 DIN 7500C SCREW TAPT.TCB M5,0X8 DIN 7500C
	17		<b>129720902</b>	TE SCREW M5X10 UNI 5739 ZNP TE SCREW M5X10 UNI 5739 ZNP
	18		<b>U110.005</b>	SCREW AUT.TCB 3,9X9,5 DIN 7981F VITE AUT.TCB 3,9X9,5 DIN 798
	19		<b>11031007</b>	CONVEYOR DUMP CONVEYOR DUMP
	20		<b>0862.112</b>	GROUNDS SACK RING 8P КОЛЬЦО ANELLO SACCO FONDI 8P
	21		<b>U110.003</b>	SCREW AUT.TCB 3,5X9,5 DIN 7981F VITE AUT.TCB 3,5X9,5 DIN 798
	22		<b>9111.527.050</b>	TUBE CONVEYOR COFFEE DISCHARGE TUBE CONVEYOR COFFEE DISCHARGE
	23		<b>11032516</b>	DUMPING SUPPORT DUMPING SUPPORT
	24		<b>11008265</b>	LOWER FLANGE OF ROTATION LOWER FLANGE OF ROTATION
	25		<b>U116.005</b>	SCREW AUT.PT TCB 3,0X8 WN 1441 VITE AUT.PT TCB 3,0X8 WN 1441 ZNP
	26		<b>NE16.002</b>	GROMMET D.11X20,5XH.7 GROMMET D.11X20,5XH.7
	27		<b>U044.011</b>	SCREW TSPC M5,0X16 UNI 7688 GALV. SCREW TSPC M5,0X16 UNI 7688 GALV.

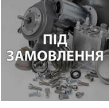

## Model Machine

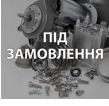
MACSAE159











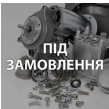



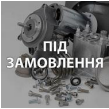

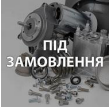



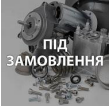





ATLANTE 700 EVO

	28		1863.649	REED FOR DOOR <i>REED FOR DOOR</i>
	29		11013949	ГНУЧКИЙ ШЛАНГ D.21 L.350 MM ГНУЧКИЙ ШЛАНГ D.21 L.350 MM <i>FLEXIBLE TUBE D.21 L.350MM</i>
	30		0862.111.050	GROUNDS DUCT <i>CONDOTTO X FONDI</i>
	31		9111.724	CONTAINER FOR COFFEE BEAN <i>CONTENITORE CAFFE' IN GRANI</i>
	32		11010736	ASS.GUILLOTINE COFFEE (1813.027) <i>ASS.GUILLOTINE COFFEE</i>
	33		9111.728	COVER FOR COFFEE CONTAINER <i>COPERCHIO CONTENITORE CAFFE'</i>
	34		11008244	MODULE 3 MOTOR <i>MODULE 3 MOTOR</i>
	35		U046.001	SCREW TEFZ M5,0X16 UNI 6921 GALV. <i>SCREW TEFZ M5,0X16 UNI 6921 GALV.</i>
	36		129724305	TE SCREW M5X40 UNI 5739 ZNP <i>TE SCREW M5X40 UNI 5739 ZNP</i>
	37		9110.139	COFFEE CONT. ASS. <i>ASS.CONTENITORE CAFFE'</i>
	38		NE05.050	MICROSWITCH <i>MICROSWITCH</i>
	39		U116.004	SCREW AUT.PT TCB 3,0X16 WN 1441 <i>SCREW AUT.PT TCB 3,0X16 WN 1441</i>
	40		11001574	FLANGE FIXING RATIOMOTOR LIP <i>FLANGIA FISSAGGIO MOTORIDUTTORI LIP</i>

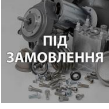
## Model Machine

MACSAE159











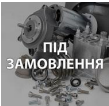

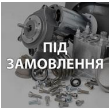













ATLANTE 700 EVO

	41		11031039	COFFEE MODULE <i>COFFEE MODULE</i>
	42		11008245	ASPIRATION STEEL SHEET AT 3 <i>ASPIRATION STEEL SHEET AT 3</i>
	43		11032453	CONVEYOR EXPIRE CAPSULS <i>CONVEYOR EXPIRE CAPSULS</i>
	44		U127.005	SCREW TAPT.TCB M4,0X8 DIN 7500C <i>SCREW TAPT.TCB M4,0X8 DIN 7500C</i>
	45		U116.003	SCREW AUT.PT TCB 3,0X12 WN 1441 <i>VITE AUT.PT TCB 3,0X12 WN 1441 ZNP</i>
	46		11031764	CONVEYOR DISCHARGE <i>CONVEYOR DISCHARGE</i>
	47		11025813	BOILER CASE ATLANTE650 BROWN <i>BOILER CASE ATLANTE650 BROWN</i>
	48		11025812	CASE OF CONDENSE ATL650 BROWN <i>CASE OF CONDENSE ATL650 BROWN</i>
	49		11008270	CASE OF CONDENSE <i>CASE OF CONDENSE</i>
	50		11008262	GRIND SUPPORT <i>SUPPORTO MACININO GRIND SUPPORT</i>
	51		11031002	CONVEYOR DUMP DISCHARGE <i>CONVEYOR DUMP DISCHARGE</i>
	52		U324.005	NUT M3 FLANGED INDENTED BASE <i>DADO M3 FLANGIATO BASE DENTELLATA</i>
	53		NE05.018	MICROSWITCH <i>MICROINTERRUTTORE SAECO XCG5-81-P5</i>
	54		11031225	SPECIAL SEAL <i>SPECIAL SEAL</i>

## Model Machine

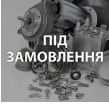
MACSAE159























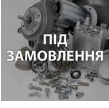

ATLANTE 700 EVO

	55		<b>11031033</b>	COFFEE MODULE 1 GRIND <i>COFFEE MODULE 1 GRIND</i>
	56		<b>11009912</b>	CONNECTOR SUPPORT SG650 <i>CONNECTOR SUPPORT SG650</i>
	57		<b>NF11.115</b>	BLIND RIVETS <i>BLIND RIVETS</i>
	58		<b>11031044</b>	CONTAINER COUPLER <i>CONTAINER COUPLER</i>
	59		<b>11031042</b>	SHEET METAL SUPPORT GROUP CAPS <i>SHEET METAL SUPPORT GROUP CAPS</i>
	60		<b>11008186</b>	ARM SUPPORT ASS. <i>ARM SUPPORT ASS.</i>
	61		<b>U110.002</b>	SCREW AUT.TCB 3,5X13 DIN 7981F <i>SCREW AUT.TCB 3,5X13 DIN 7981 F</i>
	62		<b>9161.305.150</b>	ЗАГЛУШКА РЕЗИНОВА <i>GREY 8GR.BREW UNIT INTEGRAL PISTON PLUG</i>
	63		<b>U043.031</b>	SCREW TCBC M5,0X40 UNI 7687 GALV. <i>SCREW TCBC M5,0X40 UNI 7687 GALV.</i>
	64		<b>NE05.002</b>	МІКРОВИМИКАЧ ДЛЯ КАВОМАШИНИ EF83161.8 <i>MICROINTERRUTTORE</i>
	65		<b>11025284</b>	MOTORIDUTTORE FIBER 37RPM <i>MOTORIDUTTORE FIBER 37RPM</i>
	66		<b>U110.012</b>	SCREW TC WN1412 /BN13577 ZINCBIA KA 3X2 <i>SCREW TC WN1412 /BN13577 ZINC BIA KA 3X2</i>
	67		<b>11008188</b>	CAM ARM <i>CAM ARM</i>
	68		<b>11008241</b>	CONNECTING ROD ARM <i>CONNECTING ROD ARM</i>

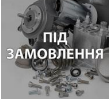
## Model Machine

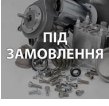
MACSAE159

ATLANTE 700 EVO

	69		11008240	SUPPORT ARM PLATE <i>SUPPORT ARM PLATE</i>
	70		9111.204	BUSH FOR SPRING COMPENSATE STIRRER <i>BOCCOLA X MOLLA BILANCERE PALETTE</i>
	71		U116.002	SCREW AUT.PT TCB 3,5X16 WN 1441 <i>SCREW AUT.PT TCB 3,5X16 WN 1441</i>
	72		11008187	NOZZLE ARM <i>BRACCIO GIREVOLE NOZZLE ARM</i>
	73		11008242	SUPPORT ARM PLATE <i>SUPPORT ARM PLATE</i>
	74		11008189	SUPPORT ARM <i>SUPPORTO BRACCIO SUPPORT ARM</i>
	75		11008268	UPPER PIN OF ROTATION <i>UPPER PIN OF ROTATION</i>
	76		129824002	TCB SCREW M4X10 UNI 7687 ZNP <i>VITE TCB M4X10 UNI 7687 ZNP</i>
	77		140321762	O-RING 3218 SILICONE <i>O-RING 3218 SILICONE</i>
	78		11032451	PLATE FOR MODULE CLOSING COFFEE GRINDER <i>PLATE FOR MODULE CLOSING COFFEE GRINDER</i>
	79		11032469	MODULE COFFEE FOR MONOCAPSULA <i>MODULE COFFEE FOR MONOCAPSULA</i>
	80		11032241	GRATE <i>GRIGLIA X CONDOTTO CAPS</i>
	81		11032831	CONVEYOR EXPIRE CAPSULS <i>CONVEYOR EXPIRE CAPSULS</i>

# Model Machine

MACSAE159

ATLANTE 700 EVO

MACSAE159.T.0020

TAVOLA NR. 20 - ARTICOLO ATLANTE 700 EVO

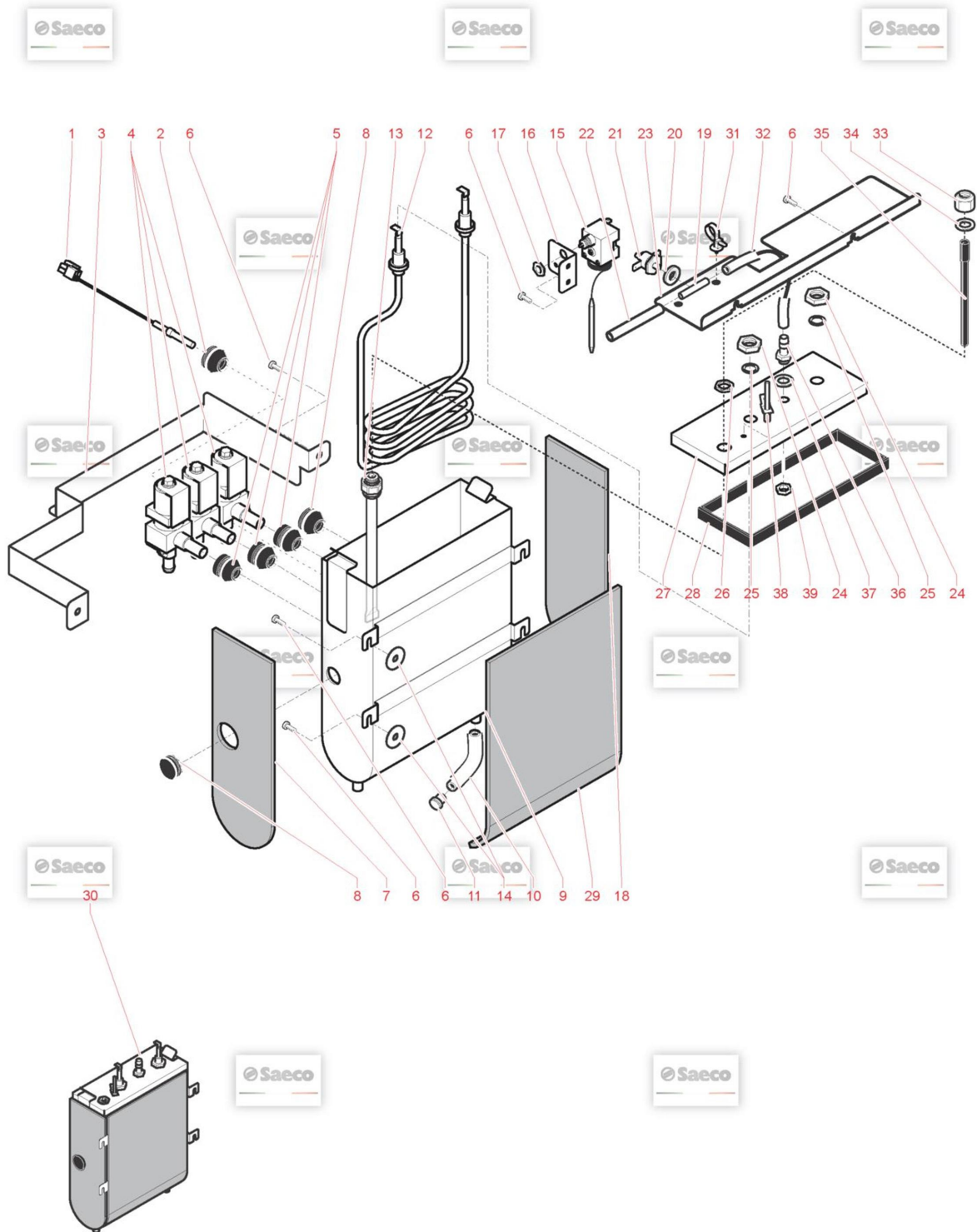

## Model Machine

MACSAE159

ATLANTE 700 EVO

Web Pos. Foto Item - Replace by Description



Press - CTRL + CLICK go to item in a new window  
Натисніть - Ctrl + права кнопка миші щоб відкрити запчастину в новому вікні



1



NE13.065

SOLUBLES PROBE ASS.  
ASS.SONDA SOLUBILI



2

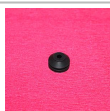

9011.210

TUBE GROMMET IMMERSION PROBE D6  
TUBE GROMMET IMMERSION PROBE D6



3

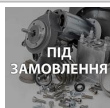

11023452

OMEGA FIXING FOR SOLUBLES ELECTROVALVE  
OMEGA FIXING FOR SOLUBLES ELECTROVALVE



4



11032608

SOLUBLE ELECTROVALVE 24VDC ODE  
SOLUBLE ELECTROVALVE 24VDC ODE



5



9111.507

СИЛІКОНОВА РЕЗИНКА БОЙЛЕРА ДЛЯ РОЗЧИННИХ РЕЧОВИН  
PASSATUBO X ELETTROV. CALDAIA



6



U127.011

SCREW TAPT.TCB M5,0X8 DIN 7500C  
SCREW TAPT.TCB M5,0X8 DIN 7500C



7

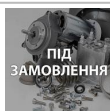

11023468

SIDE STEAM BOILER ISOLATOR  
SIDE STEAM BOILER ISOLATOR



8



9011.195

PLUG FOR BOILER  
PLUG FOR BOILER



9

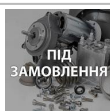

11032605

BOILER ATLANTE500  
BOILER ATLANTE500



10

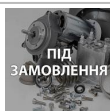

9972.313

SILICONE TUBE 7X11 L.170MM  
SILICONE TUBE 8X12 L.170 MM



11



NV03.006

CAP KAPSTO LPN 615/010  
TAPPO KAPSTO LPN 615/010



12

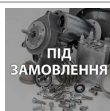

11023475

HEAT ELEMENT BOILER 230V 2160W  
HEAT ELEMENT BOILER 230V 2000W



13

















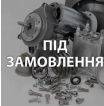

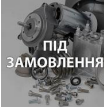

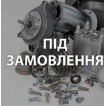





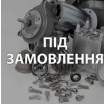

9110.068

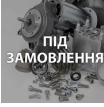
ASS.TUBE FOR LIMITER  
ASS.TUBE FOR LIMITER

## Model Machine

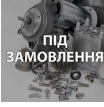
MACSAE159













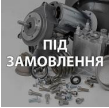







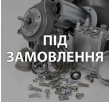

ATLANTE 700 EVO

	14		9111.501	INSULATION WASHER <i>INSULATION WASHER</i>
	15		NE09.035	LIMITER TY95H <i>LIMITATORE A RIARMO MANUALE TY95H</i>
	16		9111.598	SUPPORT <i>SUPPORT</i>
	17		NV99.093	NUT <i>NUT</i>
	18		11009951	SIDE BOILER ISOLATOR <i>SIDE BOILER ISOLATOR</i>
	19		0871.164	TUBE FOR THERMOSTAT <i>TUBE FOR THERMOSTAT</i>
	20		NV99.071	PLAIN WASHER 5,5X12 IN COPPER <i>PLAIN WASHER 5,5X12 IN COPPER</i>
	21		NE09.029	UNIPOLAR THERMOSTAT MANUAL RESET <i>TERMOSTATO UNIPOLARE RIARMO MANUALE</i>
	22		9972.226	SILICONE TUBE 7X11 L.90MM <i>SILICONE TUBE 7X11 L.90 MM</i>
	23		11031818	SEPARATOR BOILER SOLUBLE ATL700 CAPS <i>SEPARATOR BOILER SOLUBLE ATL700 CAPS</i>
	24		9991.029	NUT FOR RESISTOR <i>DADO X RESISTENZA</i>
	25		11000972	OR 3050 FKM 80 FD PEROXIDICA <i>OR 3050 FKM 80 FD PEROXIDICA</i>
	26		WGAND01/016	1/4" GAS NUT <i>1/4" GAS NUT</i>
	27		11023472	BOILER LID <i>BOILER LID</i>

## Model Machine

MACSAE159

ATLANTE 700 EVO

	28		<b>11023473</b>	ПРОКЛАДКА КРИШКИ РОЗЧИННОГО БОЙЛЕРУ ATLANTE500 <i>BOILER SEAL SOLUBLES ATLANTE500</i>
	29		<b>11023474</b>	BACK STEAM BOILER ISOLATOR ATLANTE500 <i>BACK STEAM BOILER ISOLATOR ATLANTE500</i>
	30		<b>11031831</b>	BOILER 230V CAPS <i>BOILER 230V CAPS</i>
	31		<b>NF11.043</b>	CLIP WITH HOOK <i>CLIP WITH HOOK</i>
	32		<b>9972.141</b>	SILICONE TUBE 7X11 L.160MM <i>SILICONE TUBE 7X11 L.160 MM</i>
	33		<b>9181.135</b>	NUT 1/4 TUBE D.8 PROFI <i>NUT 1/4 TUBE D.8 PROFI</i>
	34		<b>U207.005</b>	PLAIN WASHER 6,4X11 UNI 6592 GAL <i>PLAIN WASHER 6,4X11 UNI 6592 GAL</i>
	35		<b>1812.070</b>	RUBBER <i>RUBBER</i>
	36		<b>0871.141</b>	MALE RUBBER HOLDER CYL. D.9 <i>MALE RUBBER HOLDER CYL. D.9</i>
	37		<b>0871.140</b>	COPPER WASHER <i>COPPER WASHER</i>
	38		<b>12002060</b>	RIVET GROUND ONE TERMINAL 1000071 <i>RIVET GROUND ONE TERMINAL 1000071</i>
	39		<b>0871.139</b>	HEXAGONAL NUT CH.14 1/8" GAS <i>"HEXAGONAL NUT CH.14 1/8" GAS"</i>



# Model Machine

MACSAE159

ATLANTE 700 EVO

MACSAE159.T.0021

TAVOLA NR. 21 - ARTICOLO ATLANTE 700 EVO

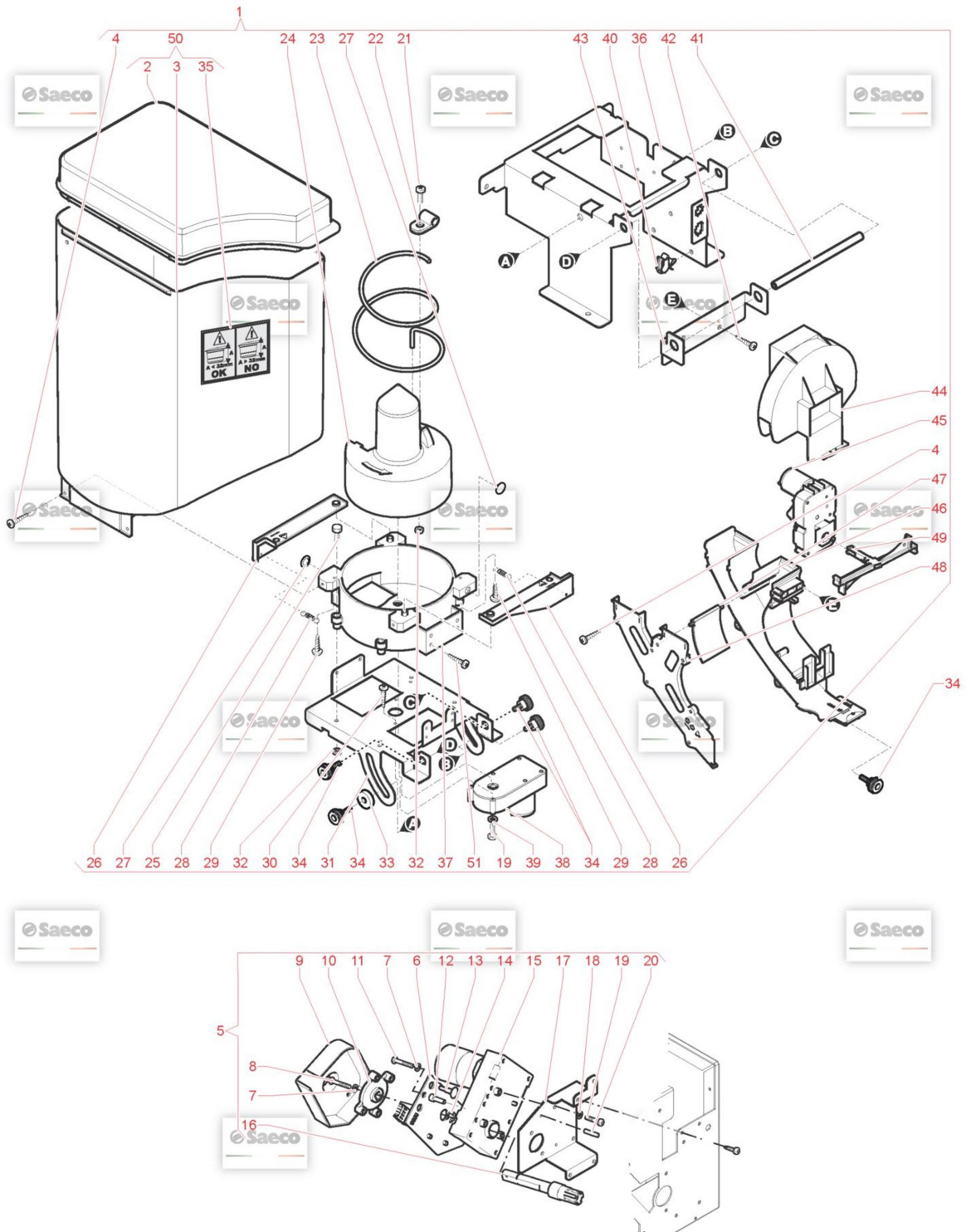

## Model Machine

MACSAE159

ATLANTE 700 EVO

Web Pos. Foto Item - Replace by Description



Press - CTRL + CLICK go to item in a new window

Натисніть - Ctrl + права кнопка миші щоб відкрити запчастину в новому вікні



1

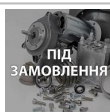

11032832

LOADER COMPLETE ATLANTE CAPSBEAN EVO  
LOADER COMPLETE ATLANTE CAPSBEAN EVO



1

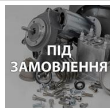

11032833

LOADER COMPLETE ATLANTE CAPS CA EVO  
AS.CARICATORE COMPL.ATLANTE CAPS CA EVO



2

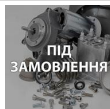

11031009

COVER CONTAINER  
COVER CONTAINER



3

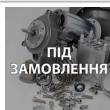

11031008

CONTAINER  
CONTAINER



4



U116.006

SCREW AUT.PT TCB 3,5X12 WN 1441 ZNP  
VITE AUT.PT TCB 3,5X12 WN 1441 ZNP



5

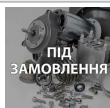

11031060

RATIOMOTOR GROUP CAPS  
RATIOMOTOR GROUP CAPS



6

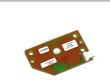

11002134

CARD 2 SENSOR RATIOMOTOR  
CARD 2 SENSOR RATIOMOTOR



7



U207.002

PLAIN WASHER 4,3X9 UNI 6592 GAL  
ROSETTA PIANA 4,3X9 UNI 6592 ZNP



8

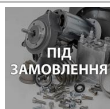

U005.010

SCREW TE M4,0X14 UNI 5739 GALV.  
SCREW TE M4,0X14 UNI 5739 GALV.



9

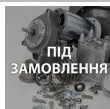

11002211

CARD PROTECTION RATIOMOTOR  
CARD PROTECTION RATIOMOTOR



10

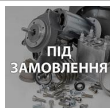

11031224

CAM  
CAM



11

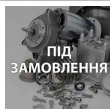

U005.012

SCREW TE M4,0X30 UNI 5739 GALV.  
SCREW TE M4,0X30 UNI 5739 GALV.



12

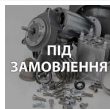











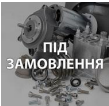

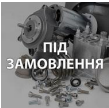













11002964

SPACE FOR CENTRAL CARD 2 SENSORY  
SPACE FOR CENTRAL CARD 2 SENSORY

## Model Machine

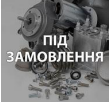
MACSAE159

















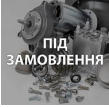





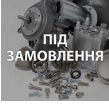

ATLANTE 700 EVO

	13		<b>NL04.014</b>	SPACER CARD H=9,5 <i>SPACER CARD H=9,5</i>
	14		<b>120340804</b>	EL. SHAFT RETAIN.RING D=8 UNI7435 <i>EL. SHAFT RETAIN.RING D=8 UNI 7435</i>
	15		<b>12000232</b>	LIP RATIOMOTOR ST.112B 24VDC 11RPM <i>LIP RATIOMOTOR ST.112B 24VDC 11RPM</i>
	16		<b>11002133</b>	JOINT WITH SHAFT FOR RATIOMOTOR <i>JOINT WITH SHAFT FOR RATIOMOTOR</i>
	17		<b>11031770</b>	SUPPORT PLATE MOTOR <i>SUPPORT PLATE MOTOR</i>
	18		<b>128310404</b>	МЕТАЛЕВЕ УБЧАСТЕ КОЛИЩАТКО UNI 8842 A4 <i>WASHER UNI 8842 A4 BURNISHED</i>
	19		<b>129824002</b>	TCB SCREW M4X10 UNI 7687 ZNP <i>VITE TCB M4X10 UNI 7687 ZNP</i>
	20		<b>U407.001</b>	ELASTIC PIN 3,0X20 UNI 6874 <i>ELASTIC PIN 3,0X20 UNI 6874</i>
	21		<b>129825002</b>	TCB SCREW M4X20 UNI 7687 ZNP <i>TCB SCREW M4X20 UNI 7687 ZNP</i>
	22		<b>12001926</b>	CABLE CLAMP SCREW FASTENING 6571 AA00 <i>CABLE CLAMP SCREW FASTENING 6571 AA00</i>
	23		<b>11031030</b>	SPECIAL SPRING <i>MOLLA AGITATORE CAPS</i>
	24		<b>11032145</b>	ROTORE CAPS <i>ROTORE CAPS</i>
	24		<b>11032373</b>	ROTORE CAPS CA <i>ROTORE CAPS CA</i>
	25		<b>129720102</b>	TE SCREW M4X20 UNI 5739 ZNP <i>TE SCREW M4X20 UNI 5739 ZNP</i>

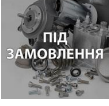
## Model Machine

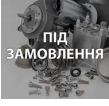
MACSAE159













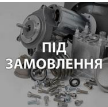







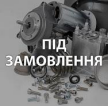



ATLANTE 700 EVO

	26		<b>11031024</b>	SAFETY LEVER CAPS <i>LEVA SICUREZZA CAPS</i>
	27		<b>NV01.006</b>	ADHESIVE FOOT <i>ADHESIVE FOOT</i>
	28		<b>9111.397</b>	SPRING FOR TRAY /LEVER COIN RECOVER <i>MOLLA X BACINELLA/LEVA RECUP</i>
	29		<b>U142.008</b>	PANELVIT TSP 3,5X12 DIN 7505 AGAL <i>PANELVIT TSP 3,5X12 DIN 7505 A GAL</i>
	30		<b>U140.017</b>	PANELVIT TCB 3,0X20 DIN 7505 BGAL <i>PANELVIT TCB 3,0X20 DIN 7505 B GAL</i>
	31		<b>11032699</b>	SUPPORT EXTERNAL ROTOR <i>SUPPORT EXTERNAL ROTOR</i>
	32		<b>U324.006</b>	NUT M4 FLANGED INDENTED BASE <i>NUT M4 FLANGED INDENTED BASE</i>
	33		<b>11008644</b>	LOCK PIN <i>LOCK PIN</i>
	34		<b>12002031</b>	KNOB D.18 M5X15 <i>KNOB D.18 M5X15</i>
	35		<b>15004268</b>	ADHESIVE HEIGHT CAPSULE CAFFITALY <i>ADHESIVE HEIGHT CAPSULE CAFFITALY</i>
	36		<b>11032710</b>	SUPPORT SHEET METAL CAPS <i>SUPPORT SHEET METAL CAPS</i>
	37		<b>11031027</b>	SUPPORTO ESTERNO ROTORE CAPS <i>SUPPORTO ESTERNO ROTORE CAPS</i>
	38		<b>11031752</b>	RATIOMOTOR 24V CAPS <i>RATIOMOTOR 24V CAPS</i>

## Model Machine

MACSAE159

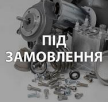
ATLANTE 700 EVO

	39		<b>U207.004</b>	PLAIN WASHER 4,3X16 UNI 6592 GAL <i>PLAIN WASHER 4,3X16 UNI 6592 GAL</i>
	40		<b>NE17.013</b>	CABLE RETAINER <i>CABLE RETAINER</i>
	41		<b>11032533</b>	ROTATION PIN <i>ROTATION PIN</i>
	42		<b>U110.002</b>	SCREW AUT.TCB 3,5X13 DIN 7981F <i>SCREW AUT.TCB 3,5X13 DIN 7981 F</i>
	43		<b>11032534</b>	SUPPORT CHANNEL LOADER <i>SUPPORTO CANALE CARICATORE</i>
	44		<b>11031025</b>	STIRRER DRAIN COVER <i>STIRRER DRAIN COVER</i>
	45		<b>11031062</b>	RATIOMOTOR 24V CAPS <i>RATIOMOTOR 24V CAPS</i>
	46		<b>11031022</b>	CHANNEL CONVEYOR CAPS <i>CHANNEL CONVEYOR CAPS</i>
	46		<b>11032638</b>	CHANNEL CONVEYOR CAPS CA <i>CHANNEL CONVEYOR CAPS CA</i>
	47		<b>11031021</b>	SWITCH CHANNEL CONVEYOR <i>SWITCH CHANNEL CONVEYOR</i>
	48		<b>11031023</b>	COVER CONVEYOR CAPS <i>COVER CONVEYOR CAPS</i>
	49		<b>11031026</b>	STIRRER DRAIN CAPS <i>STIRRER DRAIN CAPS</i>
	50		<b>11032669</b>	CONTAINER <i>CONTAINER</i>

# Model Machine

MACSAE159

ATLANTE 700 EVO

MACSAE159.T.0022

TAVOLA NR. 22 - ARTICOLO ATLANTE 700 EVO

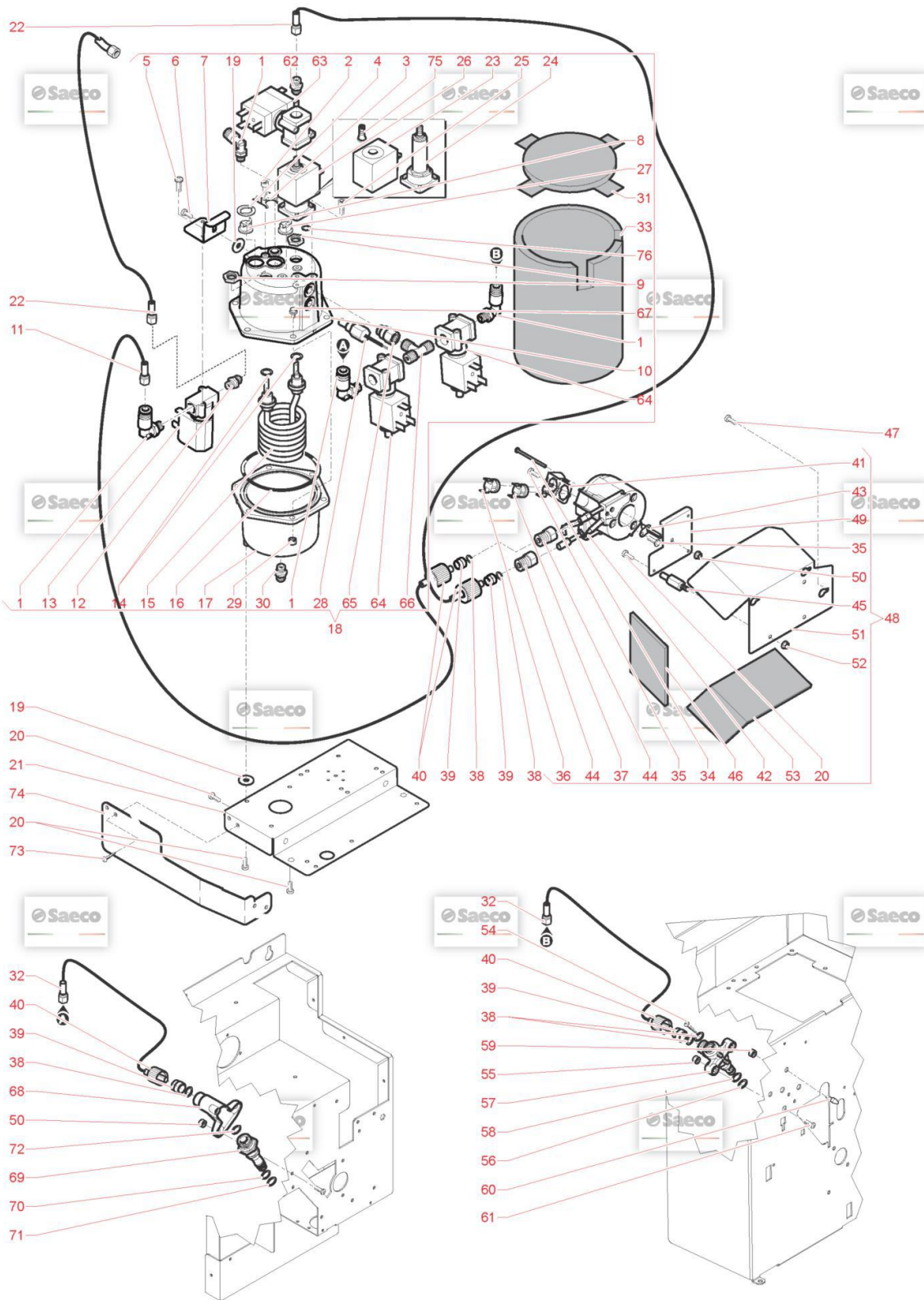

## Model Machine

MACSAE159

ATLANTE 700 EVO

Web Pos. Foto Item - Replace by Description



Press - CTRL + CLICK go to item in a new window  
Натисніть - Ctrl + права кнопка миші щоб відкрити запчастину в новому вікні



1

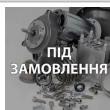

12001181

BICONICAL CONNECT. L M 1/8X06TEA  
BICONICAL CONNECT. L M 1/8X06 TEA



2



12001052

SCREW TCEI M4,0X6 DIN 912 ZIN  
SCREW TCEI M4,0X6 DIN 912 ZIN



3

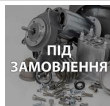

226760100

RETAINING SPRING 3 THERMOSTATS  
RETAINING SPRING 3 THERMOSTATS



4



9991.085

THERMOSTAT FIXING WASHER  
RONDELLA FERMATERMOSTATI



5



U043.007

SCREW TCBC M3,0X8 UNI 7687 GALV.  
SCREW TCBC M3,0X8 UNI 7687 GALV.



6



U043.008

SCREW TCBC M5,0X10 UNI 7687 GALV.  
SCREW TCBC M5,0X10 UNI 7687 GALV.



7

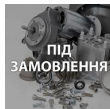

11008287

ELECTROVALVE SUPPORT  
ELECTROVALVE SUPPORT



8



NE09.021

THERMOSTAT 150°NC FASTON 90°  
THERMOSTATO 150°NC FASTON 90°



9



9991.029

NUT FOR RESISTOR  
DADO X RESISTENZA



10



11012528

UPPER CASING BOILER 600CC TEA  
UPPER CASING BOILER 600CC TEA



11



11025410

TUBE ASSEMBLY TEFLON 3X6 L.330MM  
TUBE ASSEMBLY TEFLON 3X6 L.330MM



12



9991.059

STRAIGHT BICONE CONNECTOR M 1/8X06  
STRAIGHT BICONE CONNECTOR M 1/8X06



13













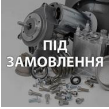







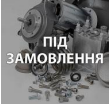





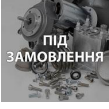

12001230

ELECTROVANNE 2 VOIES 24V DC TEA  
ELECTROVALVE 2 WAY 24 V SG 650 TEA

## Model Machine

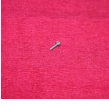
MACSAE159

ATLANTE 700 EVO



















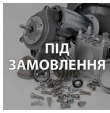



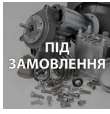

	14		<b>11000972</b>	OR 3050 FKM 80 FD PEROXIDICA <i>OR 3050 FKM 80 FD PEROXIDICA</i>
	15		<b>11005367</b>	HEAT ELEMENT BOILER 230V 1550W <i>HEAT ELEMENT BOILER 230V 1550W</i>
	16		<b>12000770</b>	OR ORM 4350 VITON <i>OR METRICO 4350 IN VITON</i>
	17		<b>11012529</b>	LOWER CASING BOILER 600CC TEA <i>LOWER CASING BOILER 600CC TEA</i>
	18		<b>11031827</b>	DOUBLE BOILER CAPS ATL700 230V50HZ TEA <i>DOUBLE BOILER CAPS ATL700 230V 50HZ TEA</i>
	19		<b>9111.501</b>	INSULATION WASHER <i>INSULATION WASHER</i>
	20		<b>12002039</b>	SCREW TCBD TORX 20 M4X12 ZN-B <i>VITE TCBD TORX 20 M4X12 ZN-B</i>
	21		<b>11008250</b>	BOILER SUPPORT <i>BOILER SUPPORT</i>
	22		<b>11009782</b>	TUBE ASS. FOR ELETTRVALVE 3 WAY <i>ASS.TUBO X ELETTRVALVOLA 3 VIE</i>
	23		<b>20006583</b>	COIL EVT HS2 11012534 <i>COIL 11005360 11006877 11012534/533</i>
	24		<b>20006584</b>	SPARE PARTS VALVE CASING 11005360 <i>SPARE PARTS VALVE CASING 11005360</i>
	25		<b>12001179</b>	SCREW TCEI M4,0X12 UNI 5931 8.8 ZIN. <i>SCREW TCEI M4,0X12 UNI 5931 8.8 ZIN.</i>
	26		<b>11012533</b>	ELECTROVALVE 3/2 WAY N.C. W/STEAM TEA <i>ELECTROVALVE 3/2 WAY N.C. W/STEAM TEA</i>
	27		<b>189428700</b>	THERMOSTAT 175° 1NT-15L-5126 <i>THERMOSTAT 175° 1NT-15L-5126</i>

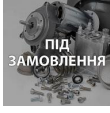

## Model Machine

MACSAE159











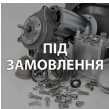





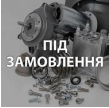

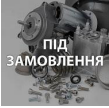

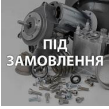



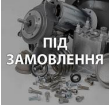

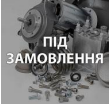
ATLANTE 700 EVO

	28		11005368	IMMERSION PROBE ASS. ASS.SONDA TEMPER.AD.IMMERSIONE
	29		U302.004	NUT HEXAGONAL M6 UNI 5588 DADO ESAGONALE M6 UNI 5
	30		11027089	WATER INLET CONNECTOR WATER INLET CONNECTOR
	31		11030776	COFFEE BOILER 600CC UPPER ISOLATOR ISOLANTE SUP.CALDAIA 600CC VENDING
	32	 ПІД ЗАМОВЛЕННЯ	11025409	TUBE ASSEMBLY TEFLON 3X6 L.220MM TUBE ASSEMBLY TEFLON 3X6 L.220MM
	33		11030778	COFFEE BOILER 600CC UPPER ISOLATOR ISOLANTE PERIMETR.CALDAIA 600CC VENDING
	34	 ПІД ЗАМОВЛЕННЯ	U043.033	SCREW TCBC M4,0X60 UNI 7687 ZNP SCREW TCBC M4,0X60 UNI 7687 ZNP
	35		129573202	SCREW TCB TORX 20 M4X8 AUTOFORMING ZN-B SCREW TAPT M4X8 UNI 8112
	36		12000804	TERMOSTAT 190 1NT-08L-6067 THERMOSTAT 190° 1NT-08L-6067
	37	 ПІД ЗАМОВЛЕННЯ	11005558	THERMOSTAT 190° NC FASTON 90° THERMOSTAT 190° NC FASTON 90°
	38		140321462	O-RING 2018 SILICONE OR 2018 IN SILICONE
	39		11005741	CONNECTOR D.6 BOCCOLA ESTERNA D.6
	40		11005743	KNURLED FEMALE HAND BOLT M14 GODRONE FEMMINA M14

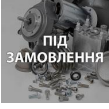
## Model Machine

MACSAE159

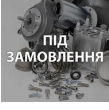











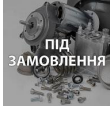

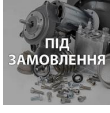

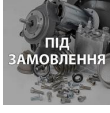

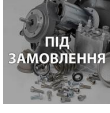

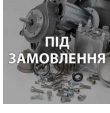



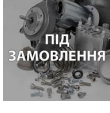

ATLANTE 700 EVO

	41		11007907	TUB.BOILER V5 SIDE THERMOS.FIXING SPRING <i>TUB.BOILER V5 SIDE THERMOS.FIXING SPRING</i>
	42		282058758	V2 TUB.BOILER N/ADDIT.RESIST.1100W 230V <i>V2 TUB.BOILER N/ADDIT.RESIST.1100W 230V</i>
	43		11009589	ДАТЧИК ПАРИ SG650 SAECO <i>STEAM PROBE SG650</i>
	44		11008257	STEAM BOILER CONNECTOR <i>STEAM BOILER CONNECTOR</i>
	45		9111.325	NOZZLE SUPPORT PIN <i>NOZZLE SUPPORT PIN</i>
	46		11011724	SIDE STEAM BOILER ISOLATOR <i>SIDE STEAM BOILER ISOLATOR</i>
	47		U127.011	SCREW TAPT.TCB M5,0X8 DIN 7500C <i>SCREW TAPT.TCB M5,0X8 DIN 7500C</i>
	48		11008266	ASS.STEAM BOILER <i>ASS.STEAM BOILER</i>
	49		11008251	STEAM BOILER SUPPORT <i>STEAM BOILER SUPPORT</i>
	50		U324.006	NUT M4 FLANGED INDENTED BASE <i>NUT M4 FLANGED INDENTED BASE</i>
	51		11010727	BOILER COVER <i>BOILER COVER</i>
	52		U324.004	NUT M6 FLANGED INDENTED BASE <i>DADO M6 FLANGIATO BASE DENTELLATA</i>
	53		11011726	STEAM BOILER ISOLATOR <i>STEAM BOILER ISOLATOR</i>
	54		U109.037	SCREW AUT.TCB 4,8X13 DIN 7981C <i>VITE AUT.TCB 4,8X13 DIN 7981 C NIK</i>

## Model Machine

MACSAE159

















ATLANTE 700 EVO

	55		<b>U302.003</b>	GALV.NUT HEXAGONAL M4 UNI 5589ZN <i>DADO ESAGONALE M4 UNI 5588 ZNP</i>
	56		<b>11013174</b>	OR ORM 0050-20 FKM 80 FD GREENPEROXIDA <i>OR ORM 0050-20 FKM 80 FD GREEN PEROXIDA</i>
	57		<b>11032620</b>	PIN FOR MUFF <i>PIN FOR MUFF</i>
	58		<b>11013173</b>	OR ORM 0090-20 FKM 80 FD GREENPEROXIDA <i>OR ORM 0090-20 FKM 80 FD GREEN PEROXIDA</i>
	59		<b>U324.003</b>	NUT M5 FLANGED INDENTED BASE <i>NUT M5 FLANGED INDENTED BASE</i>
	60		<b>11006046</b>	PEG FOR BOILER <i>PEG FOR BOILER</i>
	61		<b>U044.013</b>	SCREW TSPC M4,0X12 UNI 7688 GALV. <i>VITE TSPC M4,0X12 UNI 7688 ZNP</i>
	62		<b>9991.133</b>	STRAIGHT CONN. 1/8 D6 WITH OR <i>RACCORDO DIRITTO 1/8 D6 CON OR</i>
	63		<b>11032339</b>	EV 2 WAY 1/8" 24V DC TEA D. 2,3MM <i>EV 2 WAY 1/8" 24V DC TEA D. 2,3MM</i>
	64		<b>11023762</b>	ELECTROVALVE OLAB 3 WAYS 24V DC TEA <i>ELETTROVALVOLA OLAB 3 VIE 24V DC TEA</i>
	65		<b>11031852</b>	CONNECTOR 1/8 GAS M/F TEA CAPS <i>CONNECTOR 1/8 GAS M/F TEA CAPS</i>
	66		<b>11011454</b>	"T" CONNECTOR FOR BOILER TEA <i>RACCORDO A T X CALDAIA TEA</i>
	67		<b>U023.020</b>	SCREW TCEI M6X20 UNI 5931 ZIN <i>VITE TCEI M6X20 UNI 5931 8.8</i>
	68		<b>11031031</b>	SLEEVE CAPS <i>SLEEVE CAPS</i>

## Model Machine

MACSAE159

ATLANTE 700 EVO

	69		<b>9011.100</b>	PEG FOR VALVE IN PLASTIC <i>PEG FOR VALVE IN PLASTIC</i>
	70		<b>NM01.035</b>	OR ORM 0090-20 SILICONE <i>OR ORM 0090-20 SILICONE</i>
	71		<b>NM01.057</b>	OR ORM 0050-20 IN SILICONE <i>OR ORM 0050-20 IN SILICONE</i>
	72		<b>140320459</b>	OR ORM 0080-20 SILICONE PTFE/FDA <i>OR ORM 0080-20 IN SILICONE PTFE/FDA</i>
	73		<b>U110.004</b>	SCREW AUT.TCB 3,5X6,5 DIN 7981F <i>VITE AUT.TCB 3,5X6,5 DIN 7981 F NIK</i>
	74		<b>11032518</b>	FIXING SUPPORT BOILER-PLATE <i>FIXING SUPPORT BOILER-PLATE</i>
	75		<b>20006974</b>	MOBILE NUCLEUS OLAB 8000-836 <i>MOBILE NUCLEUS OLAB 8000-836</i>
	76		<b>20007312</b>	SPARE OR EVT HS2 11012534 <i>SPARE OR EVT HS2 11012534</i>

# Model Machine

MACSAE159

ATLANTE 700 EVO

MACSAE159.T.0023

TAVOLA NR. 23 - ARTICOLO ATLANTE 700 EVO

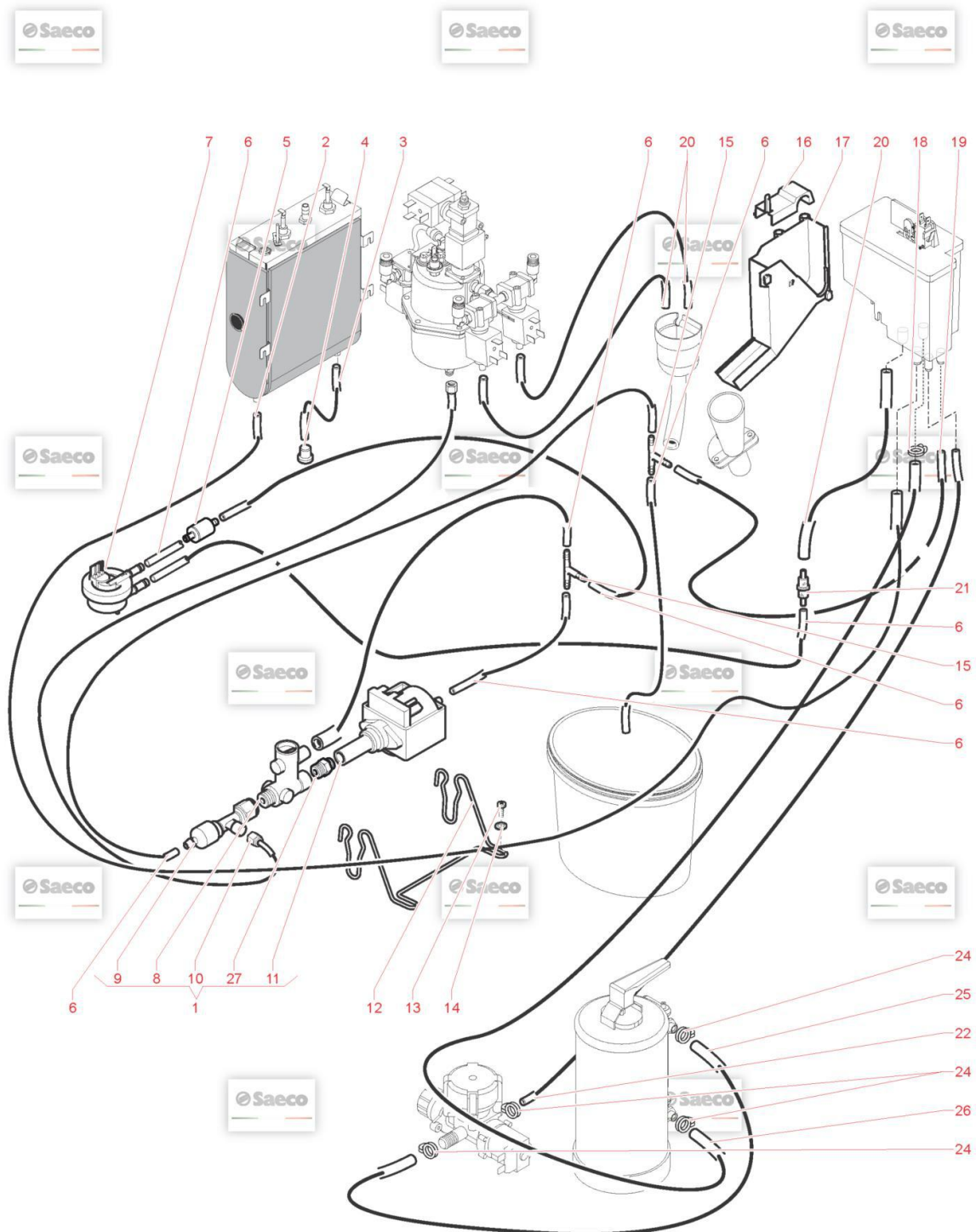

## Model Machine

MACSAE159

ATLANTE 700 EVO

Web Pos. Foto Item - Replace by Description



Press - CTRL + CLICK go to item in a new window

Натисніть - Ctrl + права кнопка миші щоб відкрити запчастину в новому вікні



1

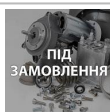

11032616

ULKA EX5 SD1 ATL700 CAPS  
ULKA EX5 SD1 ATL700 CAPS



2

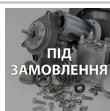

9972.224

SILICONE TUBE 7X11 L. 610MM  
SILICONE TUBE 8X12 L. 610 MM



3

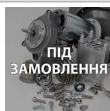

9972.313

SILICONE TUBE 7X11 L.170MM  
SILICONE TUBE 8X12 L. 170 MM



4



NV03.006

CAP KAPSTO LPN 615/010  
TAPPO KAPSTO LPN 615/010



5

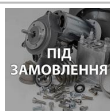

11032002

WATER FILTER  
WATER FILTER



6



9972.247

SILICONE TUBE 5X10 L.1400MM  
TUBO SILICON.5X10 L=2000MM 60 SHORE



7



NV99.099

TURBINE D=1,2 ASSY.  
TURBINA DIGMESA FHKSC 1,2 ARNITE OC



8



20007360

ОБХІДНИЙ КЛАПАН FLUID-O-TECH B7E  
BYPASS VALVE FLUID-O-TECH B7E



9



11005590

SAFETY VALVE/NON RETURN ASS. NEW  
ASS.VALVOLA SICUREZZA/NON RI



10



11025295

TEFLON TUBE 3X6 L.170 1/8"-1/8  
TEFLON TUBE 3X6 L.170 1/8-1/8



11



9070.042.00A

ULKA HACOC (ПОМПА) EX5GW 230/240V 50HZ SD1 БЪЯНКО 15 BAR  
ULKA PUMP EX5 SD1



12



9111.343

SPRING FOR MOTOR PUMP FIXING  
MOLLA X BLOCCAGGIO ELETTROPO



13





























12002052

ZN-B TCB SCREW M4X16  
ZN-B TCB SCREW M4X16

## Model Machine

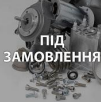
MACSAE159

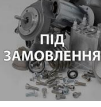
ATLANTE 700 EVO

	14		<b>U207.004</b>	PLAIN WASHER 4,3X16 UNI 6592 GAL <i>PLAIN WASHER 4,3X16 UNI 6592 GAL</i>
	15		<b>NV99.004</b>	CONNECTOR T MORONI 8026047 D=8 <i>CONNECTOR T MORONI 8026047 D=8</i>
	16		<b>9161.262.060</b>	DRIP CHANNEL COVER <i>COPERTURA CANALINO RACCOGLIGOCCE</i>
	17		<b>9111.528.050</b>	COFFEE DISCHARGE CHANNEL <i>COFFEE DISCHARGE CHANNEL</i>
	18		<b>NV99.072</b>	HOSE CLAMP D. 11.6/12.3 <i>HOSE CLAMP D. 11.6/12.3</i>
	19		<b>11013436</b>	SILICONE TUBE 5X10 L.650MM <i>SILICONE TUBE 5X10 L.650MM</i>
	20		<b>9972.055</b>	SILICONE TUBE 7X11 L.2000MM <i>SILICONE TUBE 8X12 L.2000MM</i>
	21		<b>144650300</b>	ФІЛЬТР ОЧИСТКИ ВОДИ ДЛЯ КАВОМАШИНИ SAECO NEW (NV99.001) (88... <i>ASPIRATION FILTER GAUZE NET 500 (NEW)</i>
	22		<b>11009788</b>	SILICONE TUBE 5X10 L 1600MM <i>SILICONE TUBE 6X9 L 1600MM</i>
	23		<b>184320200</b>	SPRING HOSE CLAMP D=9,5MM <i>MOLLA STRINGITUBO D=9,5MM</i>
	24		<b>NV99.050</b>	HOSECLAMP D. 13.3/14.1 <i>HOSECLAMP D. 13.3/14.1</i>
	25		<b>9972.142</b>	SILICONE TUBE 7X11 L. 400MM <i>SILICONE TUBE 8X12 L. 400 MM</i>
	26		<b>11009787</b>	SILICONE TUBE 7X11 L.1650MM <i>SILICONE TUBE 8X12 L 1650MM</i>
	27		<b>11032615</b>	FITTING ADAPTER VALVE <i>FITTING ADAPTER VALVE</i>





# Model Machine

MACSAE159

ATLANTE 700 EVO

MACSAE159.T.0024



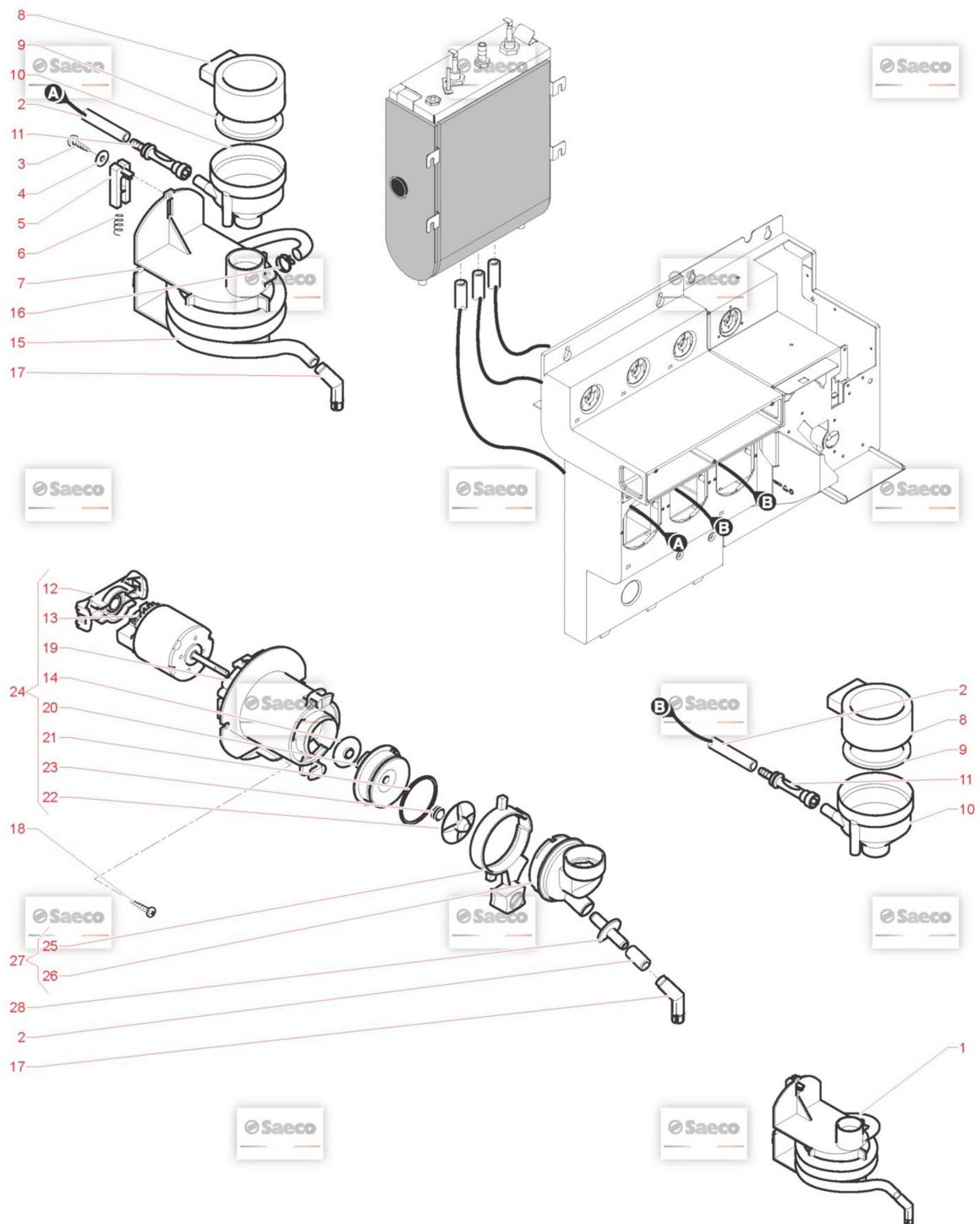























TAVOLA NR. 24 - ARTICOLO ATLANTE 700 EVO



## Model Machine

MACSAE159





























ATLANTE 700 EVO

Web	Pos.	Foto	Item - Replace by	Description
				<i>Press - CTRL + CLICK go to item in a new window Натисніть - Ctrl + права кнопка миші щоб відкрити запчастину в новому вікні</i>
	1		1863.A10	ASS.MIXER FS400 ASS.MIXER A SPIRALE FS400
	2		9972.057	SILICONE TUBE 5X8 L.2000MM TUBO SILICONE MARRON 5X8 L.2000 MM
	3		U116.005	SCREW AUT.PT TCB 3,0X8 WN 1441 VITE AUT.PT TCB 3,0X8 WN 1441 ZNP
	4		U207.004	PLAIN WASHER 4,3X16 UNI 6592 GAL PLAIN WASHER 4,3X16 UNI 6592 GAL
	5		9111.209.060	CURSOR FOR SPIRAL MIXER FIXING CURSOR FOR SPIRAL MIXER FIXING
	6		9111.211	SPRING FOR MIXER CURSOR MOLLA X CURSORE MISCELATORE
	7		9111.643.060	RAPID FIXING MIXER RAPID FIXING MIXER
	8		9111.010.060	LID FOR FUNNEL BROWN COPERCHIO X IMBUTO MARRON
	9		9111.011.060	SEAL FOR FUNNEL BROWN GUARNIZIONE X IMBUTO MARRON
	10		9111.009.060	FUNNEL FOR POWDERS BROWN IMBUTO X POLVERI MARRON
	11		11011394	NOZZLE ASS. ESPRESSO D.3 NOZZLE ASS. ESPRESSO D.3
	12		9111.771.270	MOTOR COUPLING ORANGE RAL MOTOR COUPLING ORANGE RAL
	13		9121.248.00P	MOTOP MIKCEPA '05 24V DC - M.B.T. COD. 912124800 SAECO 9121.248.00 MOTORE MIXER '05 24V DC - M.B.T.

## Model Machine

MACSAE159

ATLANTE 700 EVO

	14		9111.773.060	MOTOR PROTECTION RING <i>ANELLO PROTEZIONE MOTORE MIXER '05</i>
	15		9972.055	SILICONE TUBE 7X11 L.2000MM <i>SILICONE TUBE 8X12 L.2000MM</i>
	16		NV99.072	HOSE CLAMP D. 11.6/12.3 <i>HOSE CLAMP D. 11.6/12.3</i>
	17		9111.349	ELBOW DISPENSING NOZZLE <i>UGELLO EROGAZIONE GOMITO</i>
	18		U116.006	SCREW AUT.PT TCB 3,5X12 WN 1441 ZNP <i>VITE AUT.PT TCB 3,5X12 WN 1441 ZNP</i>
	19		9111.769.150	MIXER FLANGE <i>MIXER FLANGE</i>
	20		9111.770.060	COVER MIXER FLANGE <i>COVER MIXER FLANGE</i>
	21		NM03.012	OR ORM 0320-25 NBR <i>OR ORM 0320-25 NBR</i>
	22		9111.772.060	DISK FAN <i>VENTOLINA A DISCO MIXER '05</i>
	23		NM05.015	ПРОКЛАДКА V-RING 405 МІКСЕРА ДЛЯ КАВОМАШИН SAECO <i>V-RING MIXER '05</i>
	24		9110.160.06P	ДВИГУН МІКСЕРА ДЛЯ КАВОМАШИНИ SAECO 05 24V DC SAECO 9110.1... <i>ASS.MIXER '05 24V DC GROUP 500 SAECO</i>
	25		9111.230.270	MIXER LOCKING RING NUT ORANGERAL <i>GHIERA BLOCCAGGIO MIXER ARANCIO RAL</i>
	26		9111.227.060	MIXER CASING <i>CORPO MIXER</i>
	27		9110.027.060	MIX CASING ASS. <i>ASS.CORPO MIX SAECO CRISTALLO,ATLANTE,QUARZO,RUBINO</i>

## Model Machine

MACSAE159

ATLANTE 700 EVO



28



9111.232.060

STD TUBE HOLDER SLEEVE

*MANICOTTO PORTATUBO STANDARD*



28



9111.233.060

DECAFF.TUBE HOLDER SLEEVE

*MANICOTTO PORTATUBO DECAFFEINATO*